

YAMAHA

MUSIC SYNTHESIZER

SY55

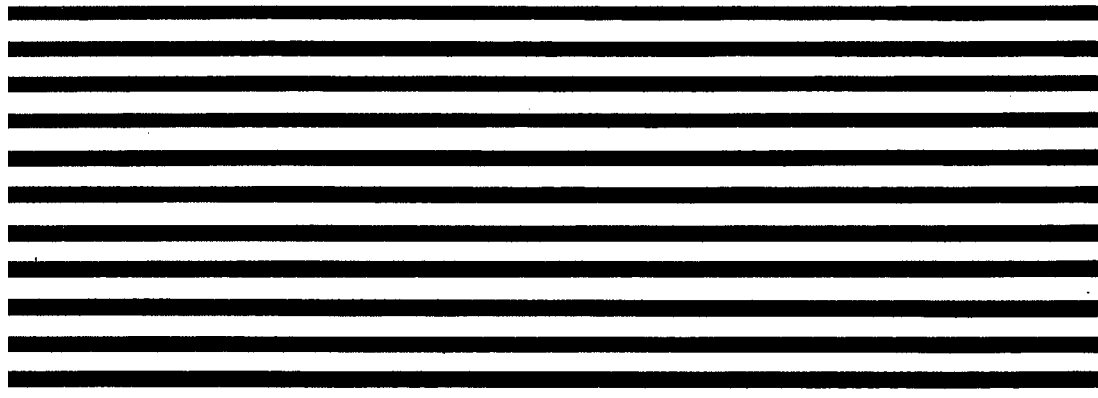

OPERATING MANUAL

Congratulations!

Your YAMAHA SY55 Music Synthesizer features a breakthrough voice architecture that allows extensive sample layering and programmable dynamic timbre variation. With the SY55, individual sampled "waves" — either those pre-programmed in ROM or others available via plug-in waveform cards — are building blocks that you arrange and process with a sophisticated dynamic filter system to create sound that's a perfect match for your music. You also have pitch envelope generators, amplitude envelope generators, a range of 34 programmable effects, real-time sound control via a range of controllers, and a wealth of other ways to customize your sound. Add to all this a sophisticated 8-track sequencer, and you have a complete music production workstation as well as an outstanding performance tool.

The SY55 is one digital synthesizer that puts samples in their proper place. Rather than rigid sounds that limit the musical outcome, the SY55's samples are flexible tools that the musician can shape, color and combine to create an original world of sound.

MAIN FEATURES

- Second-generation 16-bit AWM2 (Advanced Wave Memory) technology for superior sound.
- Versatile 1, 2, or 4-element voice architecture and complex envelope generators for extensive sample layering capability.
- Sophisticated dynamic filter system offers unlimited real-time timbre variation.
- 74 waveform samples in ROM.
- 64 preset voices in ROM.
- 64-voice internal RAM memory.
- External waveform and voice card slots.
- Multi-play mode allows independent control of up to 16 voices.
- 16 memory locations for multi-play setups.
- Drum voices allow 61 different drum and other waveforms to be assigned to different keys.
- Sophisticated built-in 8-track sequencer takes full advantage of the multi-play mode and drum-set voices.
- Velocity switching for expressive power.
- Extensive voice editing functions.
- Keyboard initial and after touch response.
- A range of controllers: pitch wheel, modulation wheel, continuous slider, breath controller jack, foot volume jack, sustain switch jack.
- 34 high-quality programmable digital effects built in.
- Stereo output.

SY55 Music Sequencer

Contents

PRECAUTIONS	2
HOW TO USE THIS OPERATION MANUAL	3
THE CONTROLS & CONNECTORS	4
■ TUTORIALS	10 *
1. SETTING UP YOUR SYSTEM	11
2. SELECTING AND PLAYING VOICES	13
3. THE MULTI PLAY MODE	19
4. RECORDING & PLAYBACK WITH THE SEQUENCER	27
5. EDITING VOICES	35
■ REFERENCE	
VOICE EDIT MODE	50 *
DRUM EDIT MODE	92 *
MULTI EDIT MODE	104 *
SEQUENCER MODE	116 *
UTILITY MODE	130 *
■ ERROR MESSAGES	144
■ SPECIFICATIONS	147
■ INDEX	148

* See these pages for local tables of contents.

PRECAUTIONS (PLEASE READ THIS BEFORE PROCEEDING!!)

1. Avoid Excessive Heat, Humidity, Dust and Vibration

Keep the unit away from locations where it is likely to be exposed to high temperatures or humidity — such as near radiators, stoves, etc. Also avoid locations which are subject to excessive dust accumulation or vibration which could cause mechanical damage.

2. Avoid Physical Shocks

Strong physical shocks to the unit can cause damage. Handle it with care.

3. Do Not Open The Case Or Attempt Repairs Or Modifications Yourself

This product contains no user-serviceable parts. Refer all maintenance to qualified YAMAHA service personnel. Opening the case and/or tampering with the internal circuitry will void the warranty.

4. Make Sure Power Is Off Before Making Or Removing Connections

Always turn the power OFF prior to connecting or disconnecting cables.

5. Handle Cables Carefully

Always plug and unplug cables — including the AC cord — by gripping the connector, not the cord.

6. Clean With a Soft Dry Cloth

Never use solvents such as benzine or thinner to clean the unit. Wipe clean with a soft, dry cloth.

7. Always Use the Correct Power Supply

The power requirements for the SY55 are clearly marked on the rear panel. Make sure the specified mains voltage matches the voltage in your area before using the unit!

8. Electrical Interference

Since the SY55 contains digital circuitry, it may cause interference and noise if placed too close to TV sets, radios or similar equipment. If such a problem does occur, move the SY55 further away from the affected equipment.

9. Memory Backup

The SY55 contains a special long-life battery that retains the contents of its internal RAM memory even when the power is turned OFF. The backup battery should last for approximately 5 years. When the battery voltage drops to a level that is too low to maintain the memory contents, the following message will appear on the SY55 display when the power is turned ON:

```
ERROR! Hit "EXIT"  
Internal Bat.Lo
```

If this display appears, have the backup battery replaced by qualified YAMAHA service personnel. DO NOT ATTEMPT TO REPLACE THE BACKUP BATTERY YOURSELF!

HOW TO USE THIS OPERATIONAL MANUAL

This operation manual is broadly divided into two main sections — TUTORIALS and REFERENCE.

What's In the TUTORIALS Section

The TUTORIALS section contains five separate tutorials that take you step-by-step through the main procedures you will need to know to become familiar with your SY55:

1. SETTING UP YOUR SYSTEM [Page 11]
Basic system connections.
2. SELECTING AND PLAYING VOICES [Page 13]
Selecting and playing voices from the PRESET, INTERNAL and CARD voice banks.
3. THE MULTI PLAY MODE [Page 19]
Creating multi-voice setups for use with the SY55 sequencer.
4. RECORDING & PLAYBACK WITH THE SEQUENCER [Page 27]
Using the SY55's internal sequencer to record and play back your original compositions.
5. EDITING VOICES [Page 35]
The basic information you need to know about the AWM2 tone generation system in order to edit voices quickly and efficiently, and general procedure for editing and creating new voices.

We recommend that you go through the tutorials in sequence while actually carrying out the procedures on your SY55. Once you've gone through the entire TUTORIALS section in this way, you should be familiar enough with the SY55 to need only the REFERENCE section in future.

What's In the REFERENCE Section

The REFERENCE section is the "nuts and bolts" section of the manual, individually describing each of the SY55's many functions or "jobs" in detail. The REFERENCE section is divided into five sub-sections, each describing the various jobs within a particular SY55 mode.

1. VOICE EDIT MODE [Page 50]
2. DRUM EDIT MODE [Page 92]
3. MULTI EDIT MODE [Page 104]
4. SEQUENCER MODE [Page 118]
5. UTILITY MODE [Page 130]

Once you have become completely familiar with the way the SY55 works by going through the TUTORIALS section, you should only need to refer to the REFERENCE section from time to time to get details on jobs you've never used before, or refresh your memory about jobs that you don't use very often.

Each sub-section or the REFERENCE section has its own table of contents, so you should be able to locate any particular job quickly and easily. Functions and references can also be located by referring to the INDEX at the back of the manual.

- 13 Liquid Crystal Display Panel** This 16-character x 2-line backlit liquid crystal display panel shows the selected voice or multi-play setup name in the voice or multi-play modes, as well as job names and parameters in the sequencer, utility, and edit modes.
- 14 [DATA ENTRY] Control** The [DATA ENTRY] control is the fastest way to select a value or item from a large range when editing.
- 15 [-1/NO] and [+1/YES] Keys** Select voices and multi-play setups, and are used to edit parameter values in any of the SY55 edit modes. Either key can be pressed briefly for single stepping in the specified direction, or held for continuous scrolling. These keys are also used to answer the "Sure?" confirmation prompt when saving or initializing data.
- 16 [◀] and [▶] Cursor Keys** Move the screen cursor from parameter to parameter in many of the SY55 editing functions.
- 17 [PAGE ◀] and [PAGE ▶] Keys** These keys are used primarily to select the various function screens in the SY55 voice, multi-play, drum, and sequencer editing modes, as well as in the utility mode.
- 18 [JOB] Key** Allows fast, direct access to any of the SY55 voice, drum, multi-play, and sequencer editing jobs.
- 19 [SELECT] Key** Allows selection of voice elements and filters during voice editing, or track record and mute assignments in the sequencer mode.
- 20 Numeric Keys** The SY55 numeric keys allow direct selection of voices or multi-play setups, editing jobs and parameter values. These keys also function as track and note-length selectors in the sequencer mode.
- 21 [ENTER] and [EXIT] Keys** The [ENTER] key is used to enter job subsets while editing, initiate data save and initialize operations, start demo playback, etc. The [EXIT] allows you to immediately exit from editing job subsets, exit from any editing or utility mode, stop demo playback, etc.
- 22 DATA and WAVEFORM Card Slots** The DATA card slot accepts YAMAHA MCD64 or MCD32 Memory Cards for storage and retrieval of SY55 voices, multi-play setups and system data.
The WAVEFORM card slot accepts pre-programmed waveform cards — i.e. cards containing sets of sampled waveforms for use in SY55 voices.

TUTORIALS SECTION

TUTORIALS

Contents

1. SETTING UP YOUR SYSTEM	11
Connections	11
Power-on Procedure	11
Enjoy the Demos	12
2. SELECTING AND PLAYING VOICES	13
The PRESET, INTERNAL and CARD Voice Banks	13
Selecting the VOICE PLAY Mode, a Voice Bank, and Voice	16
Voice Numbers 63 and 64 are Drum-set Voices	18
3. THE MULTI PLAY MODE	19
MULTI PLAY Setups	19
MULTI PLAY Mode, Bank and Setup Selection	20
MULTI PLAY Polyphony and Dynamic Note Allocation	20
Checking and Modifying MULTI PLAY Voice Assignments	20
Creating an Original MULTI PLAY Setup	22
Storing an Edited MULTI PLAY Setup	25
Conclusion	26
4. RECORDING & PLAYBACK WITH THE SEQUENCER	27
The Sequencer/Multi-Play Interface	27
Realtime Recoding: Replace & Overdub	28
Step Recording	31
Playback	34
Conclusion	34
5. EDITING VOICES	35
SY55 Voicing Basics	35
The SY55 Voice Parameter Chart	38
Programming the "VeloChorus" Voice	41
Storing an Edited Voice	46
Conclusion	47

1. SETTING UP YOUR SYSTEM

Connections

Assuming that you will not be using the SY55 with other MIDI devices for the time being, your system should be set up as shown below.

CAUTION!!: Make sure that both the SY55 and your sound system are turned OFF when making connections.

SY55

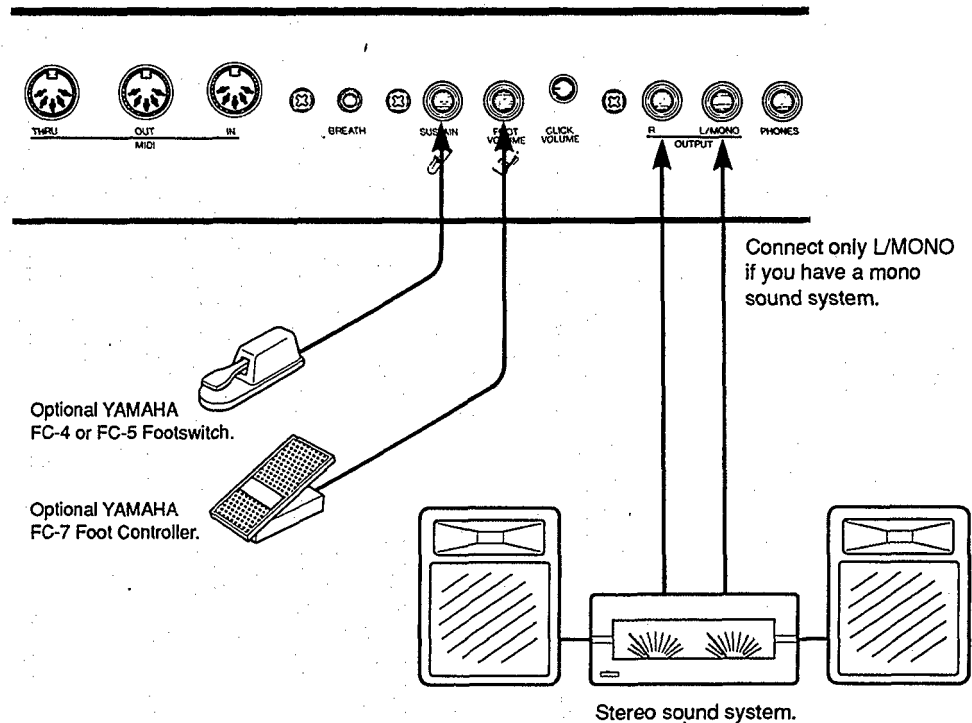

If you do connect the SY55 to other MIDI devices, be sure to use high-quality MIDI cables of not longer than about 15 meters.

Power-on Procedure

1. Make sure that both your sound system's volume control and the SY55 [MASTER VOLUME] control are turned almost all the way down prior to turning power on.
2. Turn on the SY55.
3. Turn on the sound system.
4. Carefully adjust the SY55 [MASTER VOLUME] control and your sound system's volume control while playing one of the voices (see "SELECTING AND PLAYING VOICES" on page 13).

Enjoy the Demos

The SY55 is programmed with three demo tunes that you might enjoy listening to after setting up your system. Take a short break and enjoy the demos:

1. Press and then release the SEQUENCER [◀] and [▶] keys at the same time.
2. Press the [ENTER] key to start demo playback.
3. Press the [EXIT] key when you want to stop demo playback. Pressing [EXIT] a second time returns you to the mode the SY55 was in prior to the demo playback mode.

2. SELECTING AND PLAYING VOICES

The PRESET, INTERNAL and CARD Voice Banks

Here's a global view of the SY55 system:

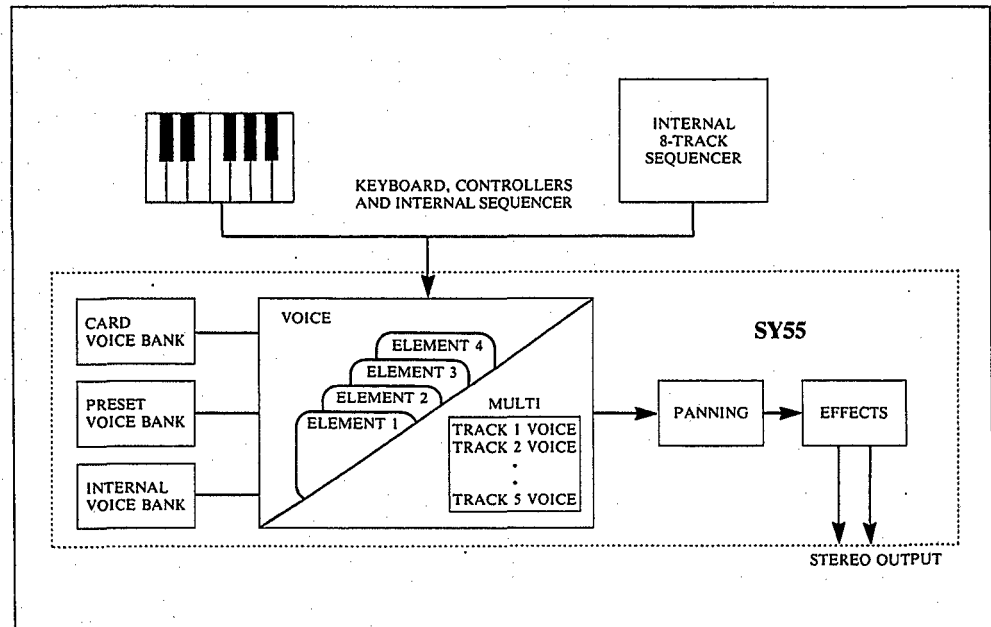

Please note that the voices played by the SY55 can come from three different sources: the PRESET voice bank, the INTERNAL voice bank, or a CARD voice bank:

PRESET

The PRESET voice bank contains 64 pre-programmed voices in ROM (Read Only Memory) that cannot be overwritten or changed in any way. The PRESET voice bank is represented on the display by the letter "P".

INTERNAL

The INTERNAL voice bank is a RAM (Random Access Memory) area into which you can store up to 64 voices that you create or load from an external memory card. The INTERNAL voice bank is represented on the display by the letter "I".

CARD

The CARD memory bank is a YAMAHA MCD64 or MCD32 Memory Card (or pre-programmed voice card) plugged into the SY55 DATA card slot on the front panel. Memory cards are convenient for external storage and transportation of voices that you or others create. You can also store sets of related voices on different memory cards. An MCD32 Memory Card allows storage of up to 64 voices. An MCD64 Memory Card holds two banks of 64 voices each — a total of 128 voices per card. The CARD voice bank is represented on the display by the letter "C" (the second bank of MCD64 cards is represented by a reversed "C").

Any voice in any of these voice banks can be selected and played while the SY55 is in the VOICE PLAY mode.

● PRESET VOICE LIST

No.	EL*	Name	No.	EL	Name	No.	EL	Name
1	1	Piano	23	4	Big Band	45	2	VCO Lead
2	2	Voyager	24	2	Orch Brass	46	2	Spirit VCF
3	2	Pro55Brass	25	2	SynthBrass	47	2	OZ Lead
4	2	Elektrodes	26	1	Flule	48	4	Get Lucky
5	4	Zuratustra	27	1	Saxophone	49	4	Gamma Band
6	2	DawnChorus	28	2	FolkGuitar	50	2	Metal Reed
7	2	GX Dream	29	2	12 String	51	4	Modomatic
8	2	GrooveKing	30	2	MuteGuitar	52	2	DataStream
9	4	DistGuitar	31	2	SingleCoil	53	2	Mystichoir
10	4	ZenAirBell	32	1	Pick Bass	54	2	St.Michael
11	2	FullString	33	2	Thumb Bass	55	2	Scatter
12	4	Jazz Man	34	2	SynBadBass	56	2	Triton
13	2	ClassPiano	35	2	VCO Bass	57	4	Amazon
14	2	Rock Piano	36	2	Violin	58	2	SatinGlass
15	1	DX E.Piano	37	1	ChamberStr	59	4	BrassChime
16	2	Hard EP	38	2	VCF String	60	2	Piano Mist
17	2	Cry Clav	39	2	Nova Quire	61	4	Xanadu
18	2	Funky Clav	40	2	Vibraphone	62	2	WdBass Duo
19	2	Deep Organ	41	2	Takerimba	63	(61)	Drum Set 1
20	2	Warm Organ	42	1	Gloken	64	(61)	Drum Set 2
21	1	Trumpet	43	2	DigiBell			
22	4	Slab Brass	44	2	Oriental			

* EL=Number of elements sec page 35.

No.	Name	Comments
P01	Piano	Orthodox acoustic piano.
P02	Voyager	Choir with "sizzle." Play long chords.
P03	Pro55Brass	Fat analog brass pad.
P04	Elektrodes	Mellow electric piano.
P05	Zaratustra	Big orchestra. Brass volume on MW.
P06	DawnChorus	Breathy choir. MW fades out breath.
P07	GX Dream	A punchy voice reminiscent of the YAMAHA GX1.
P08	GrooveKing	Classic funky, resonant synth voice.
P09	DistGuitar	Heavy guitar. Slow fade to feedback.
P10	ZenAirBell	Percussive bell/gong combination.
P11	FullString	Light touch for small, heavy for large string section.
P12	JazzMan	Split wood bass and trumpet. MW swaps horns.
P13	ClassPiano	Classical Grand Piano
P14	RockPiano	Fat piano. Perfect for chord work.
P15	DX E.Piano	Electronic piano.
P16	Hard EP	Electric piano with sharp attack and hard tone.
P17	Cry Clav	Automatic "wah" clav with resonant attack.
P18	Funky Clav	Fat, funky clav.
P19	Deep Organ	Rock Organ
P20	Warm Organ	Full, rich organ with rotating speaker effect.
P21	Trumpet	Solo trumpet.
P22	Stab Brass	Thin pop brass section.
P23	Big Band	Big unison horn section. Play in octaves. MW fades to solo trumpet.
P24	Orch Brass	Big classical brass section with pan.

No.	Name	Comments
P25	SynthBrass	Powerful synth brass pad.
P26	Flute	Breathy when played hard.
P27	Saxophone	Solo sax with lots of presence.
P28	FolkGuitar	Steel-string acoustic folk guitar.
P29	12 String	Full 12-string guitar.
P30	MuteGuitar	Muted electric guitar.
P31	SingleCoil	Single-coil electric guitar pickup.
P32	Pick Bass	Punchy picked bass.
P33	Thumb Bass	Play hard for slap bass sound.
P34	SynBadBass	Funky synth bass.
P35	VCO Bass	Fat analog bass.
P36	Violin	Solo violin with after-touch vibrato.
P37	ChamberStr	Small violin section.
P38	VCF String	Analog synth strings. Brightness on MW.
P39	Nova Quire	Choir with a unique attack.
P40	Vibraphone	Traditional vibraphone with tremolo on MW.
P41	Takerimba	Bamboo marimba. Brightness on MW.
P42	Glocken	Glockenspiel. Brightness on MW.
P43	DigiBell	Spacious synth bell.
P44	Oriental	Oriental orchestra. Light touch for string section only.
P45	VCO Lead	Analog sawtooth lead voice.
P46	Spirit VCF	Analog synth with big, slow filter sweep.
P47	OZ Lead	Soft synth lead.
P48	Get Lucky	Fat square-wave synth sound with detune on MW.
P49	Gamma Band	Oriental percussion ensemble. MW fades in metal drums and bells.
P50	Metal Reed	Harmonica or accordion with after-touch pitch bend.
P51	Modomatic	Choir with big MW filter sweep.
P52	DataStream	Best with long notes.
P53	Mystichoir	Play long chords for shifting notes.
P54	St.Michael	Choir with bells on release.
P55	Scatter	Voice on staccato notes, filtered synth on long tones.
P56	Triton	Best with long chords.
P57	Amazon	Wide touch range.
P58	SatinGlass	Metallic, spacious synth voice.
P59	BrassChime	Filtered brass with chimes.
P60	Piano Mist	Piano bell. MW fades to staccato filtered voice.
P61	Xanadu	Solo multi-tuned flute.
P62	WdBass Duo	Split wood bass and piano.
P63	Drum Set 1	Drum set including bass and sound effects.
P64	Drum Set 2	Drum set including bass and sound effects.

Selecting the VOICE PLAY Mode, a Voice Bank, and Voice

1. If the VOICE PLAY mode is not already selected — as indicated by a lit [VOICE] key LED and "VOICE PLAY" across the top of the LCD — press the [VOICE] key to select it.



2. The [INTERNAL], [CARD] and [PRESET] keys are used to select the desired voice bank. If no memory card is inserted in the DATA slot, pressing the [CARD] key has no effect.

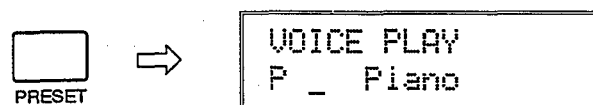
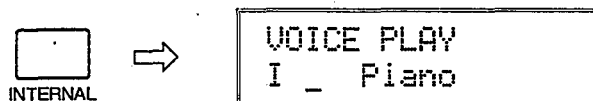

If a 2-bank memory card such as an MCD64 is inserted into the DATA slot and both banks of the card are properly formatted ("REFERENCE" section, page 138), pressing the [CARD] key alternately selects bank 1 (indicated by "C" on the display) or bank 2 ("C" on the display).

3. The [-1/NO] and [+1/YES] keys can be used to select the desired voice within the current bank. Holding the [-1/NO] and [+1/YES] causes continuous scrolling in the specified direction.

Any voice can also be directly selected by inputting its number via the numeric keys and then pressing [ENTER]. The entered number will flash on the display until the [ENTER] key is pressed, indicating that a new voice number has been selected but the voice has not yet been recalled.

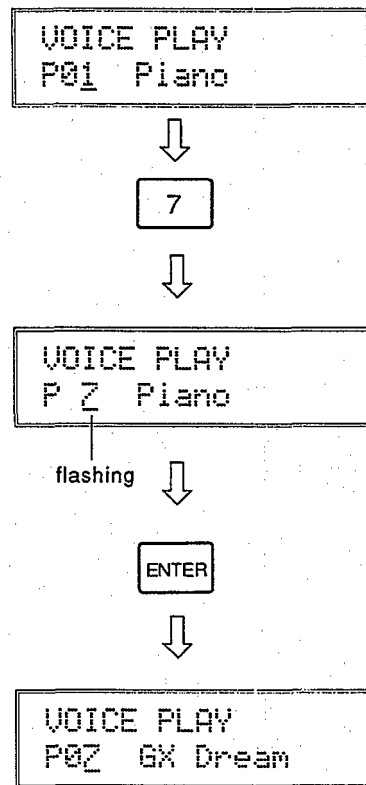

Special technique: If you press the [SELECT/HOLD] key while in the voice play mode, "Hold" will appear in the upper right-hand corner of the display. This function "holds" the current tens digit of the voice number so that pressing a numeric key changes only the ones digit, directly calling the corresponding voice without the need to press the [ENTER] key. If, for example, the [SELECT/HOLD] key is pressed while a voice in the thirties is selected, then pressing numeric key [1] will immediately select voice number 31, the [5] key will immediately call voice number 35, etc. The hold mode can be released by pressing the [SELECT/HOLD] key a second time.

4. Play the selected voice via the SY55 keyboard.

If you don't get any sound at this point:

- Make sure your sound system is turned ON and the volume is turned up to a reasonable level.
- Make sure that the SY55 MASTER VOLUME control is turned up to a reasonable level.
- Check all connections.

Voice Numbers 63 and 64 are Drum-set Voices

Although most SY55 voices have a 1, 2 or 4-element configuration (we'll learn more about elements in the "EDITING VOICES" section, beginning on page 35), voices 63 and 64 in any voice bank are special drum-set voices that essentially have a 61-element configuration. Each element, in this case, corresponds to a different key on a keyboard. A range of high-quality drum and percussion waveforms can be assigned to the different elements/keys and handled as a single voice — i.e. each key plays a different instrument within that "drum set."

The drum-set voices are particularly useful with the SY55's MULTI PLAY mode and sequencer, described in the following two sections.

● Voice 63: Drum Set 1

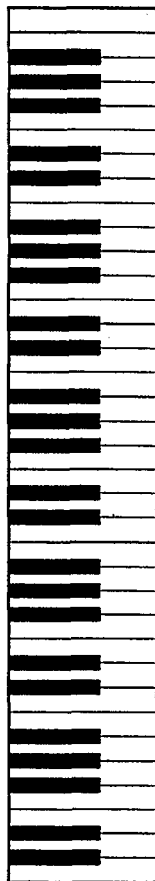

Key	Wave Name	No.	Key	Wave Name	No.
			C6	Syn Bass	P28
			B5	Syn Bass	P28
A#5	Syn Bass	P28	A5	Syn Bass	P28
G#5	Syn Bass	P28	G5	Syn Bass	P28
F#5	Syn Bass	P28	F5	Syn Bass	P28
			E5	Syn Bass	P28
D#5	Syn Bass	P28	D5	Syn Bass	P28
C#5	Syn Bass	P28	C5	Syn Bass	P28
			B4	Bulb	P57
A#4	Vocal Ga	P53	A4	Vocal Ga	P53
G#4	Bell Mix	P58	G4	Bottle	P51
F#4	Bottle	P51	F4	Bottle	P51
			E4	Styroll	P56
D#4	Shaker	P74	D4	Ride	P71
C#4	Bamboo	P54	C4	Vibe Np	P50
			B3	Vibe Np	P50
A#3	Claps	P72	A3	Claps	P72
G#3	Popping	P26	G3	Popping	P26
F#3	Tube	P52	F3	Tube	P52
			E3	Tube	P52
D#3	Ride	P71	D3	Ride	P71
C#3	Crash	P70	C3	Crash	P70
			B2	HH open	P69
A#2	Crash	P70	A2	HH closed	P68
G#2	Shaker	P74	G2	Cowbell	P73
F#2	Claps	P72	F2	Tom 1	P66
			E2	SD 1	P62
D#2	Rim	P65	D2	Tom 1	P66
C#2	SD 2	P63	C2	Tom 1	P66
			B1	Tom 1	P66
A#1	SD 3	P64	A1	BD 1	P59
G#1	BD 2	P60	G1	Tom 2	P67
F#1	Tom 2	P67	F1	Tom 2	P67
			E1	Tom 2	P67
D#1	BD 3	P61	D1	BD 3	P61
C#1	BD 2	P60	C1	BD 2	P60

● Voice 64: Drum Set 2

Key	Wave Name	No.	Key	Wave Name	No.
			C6	Syn Bass	P28
			B5	Syn Bass	P28
A#5	Syn Bass	P28	A5	Syn Bass	P28
G#5	Syn Bass	P28	G5	Syn Bass	P28
F#5	Syn Bass	P28	F5	Syn Bass	P28
			E5	Syn Bass	P28
D#5	Syn Bass	P28	D5	Syn Bass	P28
C#5	Syn Bass	P28	C5	Syn Bass	P28
			B4	Bulb	P57
A#4	Vocal Ga	P53	A4	Vocal Ga	P53
G#4	Bell Mix	P58	G4	Bottle	P51
F#4	Bottle	P51	F4	Bottle	P51
			E4	Styroll	P56
D#4	Shaker	P74	D4	Ride	P71
C#4	Bamboo	P54	C4	Vibe Np	P50
			B3	Vibe Np	P50
A#3	Claps	P72	A3	Claps	P72
G#3	Popping	P26	G3	Popping	P26
F#3	Tube	P52	F3	Tube	P52
			E3	Tube	P52
D#3	Ride	P71	D3	Ride	P71
C#3	Crash	P70	C3	Crash	P70
			B2	HH open	P69
A#2	Crash	P70	A2	HH closed	P68
G#2	Shaker	P74	G2	Cowbell	P73
F#2	Claps	P72	F2	Tom 2	P67
			E2	SD 2	P63
D#2	Rim	P65	D2	Tom 2	P67
C#2	SD 1	P62	C2	Tom 2	P67
			B1	Tom 2	P67
A#1	SD 3	P64	A1	BD 2	P60
G#1	BD 1	P59	G1	Tom 1	P66
F#1	Tom 1	P66	F1	Tom 1	P66
			E1	Tom 1	P66
D#1	BD 3	P61	D1	BD 3	P61
C#1	BD 1	P59	C1	BD 1	P59

3. THE MULTI PLAY MODE

MULTI PLAY Setups

The SY55 MULTI PLAY (multi-timbre) mode allows different voices to be assigned to up to 16 different MIDI channels. This allows you to record and play multi-voice compositions using the SY55's internal 8-track sequencer, or an external sequencer if desired.

Here's an example — the preset "POP" multi-play setup (MULTI P01):

● **MULTI P01: POP instruments and channel assignments**

- Channel-1 voice Pick Bass
- Channel-2 voice Deep Organ
- Channel-3 voice Trumpet
- Channel-4 voice Saxophone
- Channel-5 voice off
- Channel-6 voice off
- Channel-7 voice off
- Channel-8 voice Drum Set 2
- Channel-9 voice off

- Channel-16 voice: off

In addition to 16 PRESET MULTI PLAY setups including the one described above, 16 INTERNAL memory locations are provided for complete "MULTI PLAY" setups including voice-to-channel assignments, individual voice volume, note shift, tuning, panning, and effects. This allows you to create up to 16 original "orchestras" with different combinations of voices that can be recalled whenever needed. MULTI PLAY setups can also be stored on external memory cards in the same way as ordinary voices.

MULTI PLAY Mode, Bank and Setup Selection

The MULTI PLAY mode, memory banks and individual MULTI PLAY setups are selected in the same way as the SY55 voices:

- [MULTI] to select the MULTI PLAY mode.
- [INTERNAL], [CARD] or [PRESET] to select the desired memory bank.
- [-1/NO] and [+1/YES] or numeric keys plus [ENTER] to select the desired MULTI PLAY setup.

MULTI PLAY Polyphony and Dynamic Note Allocation

Since the SY55 can produce a maximum of 16 notes at the same time (16-note polyphony), the number of simultaneous notes that each voice in a MULTI PLAY setup can produce depends on the number of voices being played at the time. If all 16 voices are played at once, each can only produce a single note. On the other hand, if only one voice is being played the SY55's "Dynamic Note Allocation" feature allows 16 notes to be played simultaneously by that one voice even if 16 voices are assigned.

The SY55 also has a RESERVED NOTE function that allows you to specify a minimum number of notes for each voice ("REFERENCE" section, page 110).

Checking and Modifying MULTI PLAY Voice Assignments

Here's how you can see what voices are assigned to the various channels in any MULTI PLAY setup, and change the voice assignments temporarily to try out alternative voices.

1. When you first select the MULTI PLAY mode by pressing the [MULTI] key, a display similar to the following will appear:

```
MULTI PLAY
P01 P0P
```

At this point you can use the [-1/NO] and [+1/YES] keys or numeric keys plus [ENTER] to select any of the 16 MULTI PLAY setups within the current bank.

2. If you press either the [PAGE ◀] or [PAGE ▶] key after selecting the desired MULTI PLAY setup, a display similar to the following will appear:

```
<Pick Bass >
  CH 1=P32
```

This display allows you to see and change the voices assigned to each channel. In the above display, "CH 1=P32" on the bottom line indicates that voice P32 is assigned to channel 1 (CH 1). Voice P32 is "Pick Bass," as indicated on the top display line. Note the underline cursor under the "1" of "CH 1."

3. While the underline cursor is positioned below the channel (CH) parameter, the [-1/NO] and [+1/YES] keys or numeric and [ENTER] keys can be used to select any of the 16 MIDI channels and see which voices are assigned to each.
4. When you're done checking the voice assignments you can return to the normal MULTI PLAY mode display by pressing either the [PAGE ◀] or [PAGE ▶] key ... or you could continue and temporarily change one or more voices assignments as described in the following steps.
5. To change a voice assignment, first select the channel to which the new voice will be assigned, as described in the preceding steps.
6. Move the cursor to the voice parameter by pressing the [↔] key. The underline cursor should now be located under the voice number.
7. Use the [-1/NO] and [+1/YES] keys or numeric and [ENTER] keys to select the new voice for that channel, or turn the channel "off" (decrementing below voice number 01 selects "off"). Different memory banks can be selected by using the [MEMORY] key.

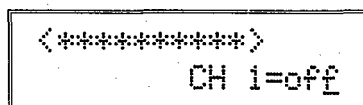

8. To assign a new voice to a different channel, simply move the cursor back to the channel parameter by pressing the [◀] key and repeat the above procedure.

Note: This function is primarily intended for checking voice assignments and making temporary changes to try out different voices in a MULTI PLAY setup. Voice assignment changes are only temporary and the original voice assignments will be restored as soon as a different MULTI PLAY setup or mode is selected. Permanent changes can be made in the MULTI PLAY EDIT mode, described next.

Creating an Original MULTI PLAY Setup

In this section we'll go through the steps to create a simple "Jazz Quartet" MULTI PLAY setup consisting of the following voices:

Channel 1P01 Piano
Channel 2P62 WdBass Duo
Channel 3P40 Vibraphone
Channel 4P63 Drum Set 1
Channels5...16...off

Note: P62 WdBass Duo is actually a split voice with wood bass ranging from C-2 to E3 and piano on all higher keys up to G8.

1. If it is not already selected, press [MULTI] to select the MULTI PLAY mode.
2. Use the [INTERNAL], [-1/NO] and [+1/YES] keys to select MULTI PLAY setup I01.

```
MULTI PLAY
I01 POP
```

3. Press [EDIT/COMPARE] to enter the MULTI PLAY EDIT mode.
4. If a display similar to the following is not showing, press the [JOB] key, then the numeric" [1] key, and finally the [ENTER] key to select it (while the [PAGE◀] and [PAGE▶] keys can be used to step forward and backward through the jobs in any edit mode, using job numbers is often the fastest way to access a specific editing job — "REFERENCE" section, page 52).

```
<Pick Bass >CH 1
#P32 P19 P21 P27
```

This is the display for the MULTI PLAY EDIT mode voice assignment function ("REFERENCE" section, page 108).

5. The [◀] and [▶] cursor keys are used to move the cursor (▄) to the desired channel (a channel number between CH1 and CH16 will appear in the upper right-hand corner of the display), and the [DATA ENTRY] control, [+1/YES] and [-1/NO], keys or numeric and [ENTER] keys are used to assign the desired voice to the selected channel.
 - With the cursor at the channel-1 position, make sure the P01 (Piano) voice is selected.
 - Move the cursor to the channel-2 position by pressing [▶], then select voice P62 (WdBass Duo).
 - Move the cursor to the channel-3 position by pressing [▶], then select voice P40 (Vibraphone).
 - Move the cursor to the channel-4 position by pressing [▶], then select voice P63 (Drum Set 1).

- Move the cursor to all the remaining channel positions (5 ... 16) and turn each "off" by holding the [-1/NO] key until the "off" display appears. Note that the cursor can be moved past the end of the display screen to access the remaining channels in groups of four.

```

<Piano      >CH 1
▶P01 P62 P40 P63
    
```

6. Press the [PAGE ▶] key to move to the next MULTI PLAY EDIT mode job: Volume ("REFERENCE" section, page 108).

```

Volume      CH 1
▶127 127 127 127
    
```

7. The volume job operates in basically the same way as the voice assignment job described above. The [◀] and [▶] cursor keys are used to select the channel/voice for which the volume is to be adjusted, then the [DATA ENTRY] control, [+1/YES] and [-1/NO] keys, or numeric and [ENTER] keys are used to set the desired volume. A setting of "0" produces no sound while a setting of "127" produces maximum volume.

With the Jazz Quartet setup, the relatively gentle wood bass sound tends to become "buried" under the other instruments, so leave its volume setting at the maximum of 127, and lower the other three voices to about 110.

```

Volume      CH 1
▶110 127 110 110
    
```

Volume

Piano	110
WdBass Duo	127
Vibraphone	110
Drum Set 1	110

8. Press the [JOB] key, the numeric [5] key, and then the [ENTER] key to move to the Reserved Note job ("REFERENCE" section, page 110). We'll skip the Note Shift and Tune ("REFERENCE" section, page 109) jobs for this setup, since we don't need to tune or transpose the pitch of any of the voices in the Jazz Quartet setup.

```

ReserveNote CH 1
▶ 0 0 0 0
    
```

9. The main use for Reserved Note job is to ensure that a minimum number of notes are available to specific instruments even under circumstances in which less would normally be available. In this case we'll set channel 1 (Piano) to 8 since jazz piano tends to involve a lot of "thick" chord work, and channel 3 (Vibraphone) to 4, which is enough for two-handed phrases. This simply means that there will always be at least 8 notes available for piano and 2 notes available for vibraphone (Vibraphone uses 2-elements: 2 elements x 2 notes = 4), no matter how many notes are played at the same time by bass and drums. If the total number of notes played exceeds 16 at any instant, the bass or drum voice notes will be truncated rather than the piano or vibes notes.

Reserved Note

```
Piano .....8
WdBass Duo .....0
Vibraphone .....4
Drum Set 1 .....0
```

The [◀] and [▶] cursor keys are used to select the voice/channel, then the [DATA ENTRY] control, [+1/YES] and [-1/NO] keys, or numeric and [ENTER] keys are used to set the number of reserved notes.

10. Press the [PAGE▶] key to move to the next MULTI PLAY EDIT mode job: Pan ("REFERENCE" section, page 110).

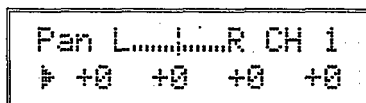

11. This job allows each individual voice in the setup to be panned to a different position in the stereo sound field (you'll only hear this if you're using a stereo sound system fed by the SY55 OUTPUT R and L/MONO jacks).

As always, the [◀] and [▶] cursor keys are used to select the voice/channel for which the pan position is to be set, then the [DATA ENTRY] control, [+1/YES] and [-1/NO] keys, or numeric and [ENTER] keys are used to set the pan position.

The upper line of the display also shows a graphic representation of the stereo sound field with "L" representing "left" and "R" representing "right." As you change the pan value the vertical bar will appear at the corresponding position on the graphic display.

Set the pan positions of the Jazz Quartet voices as follows:

Pan

```
Piano .....-17 (half way to the left)
WdBass Duo .....-9 (slightly to the left)
Vibraphone .....+17 (halfway to the right)
Drum Set 1 .....+5 (slightly to the right)
```

12. Press the [PAGE▶] key once to move on to the Effect Level job ("REFERENCE" section, page 111).

```

EF Level   CH 1
▶100 100 100 100
    
```

- The Effect Level job individually sets the effect level for each voice in the setup. You know how to move the cursor around and change settings by now.

Set the Effect Level for all four voices to 100 (this is equivalent to the individual voice effect level settings).

Effect Level

```

Piano .....100
WdBass Duo .....100
Vibraphone .....100
Drum Set 1 .....100
    
```

A hall reverb effect is already selected for the I01 MULTI PLAY setup, so we won't bother with the many possible effect settings for now ("REFERENCE" section, page 86).

- Press the [PAGE ▶] key twice to move on to the MULTI Name job ("REFERENCE" section, page 113).

```

MULTI Name
"POP"
    
```

- Here's where we actually name our MULTI PLAY setup: "Jazz Quart". The MULTI Name job allows a name of up to 10 characters to be assigned to the current setup. Use the [◀] and [▶] cursor keys to place the underline cursor under the character to be changed, then use the [DATA ENTRY] control or [+1/YES] and [-1/NO] keys to select the desired character. Continue until the entire voice name has been programmed.
- Press [MULTI] to exit from the edit mode and return to the MULTI PLAY mode. The reversed letter "E" that appears to the right of the voice number indicates that the MULTI PLAY setup has been edited.

Caution!!: If you select a different MULTI PLAY setup or mode at this point, the edited MULTI PLAY setup will be erased. To keep an edited setup, it must be stored to an INTERNAL or CARD memory location, as described in the following section. For a special method of recalling a multi-play setup lost in this way, see "MULTI RECALL" on page 113.

Storing an Edited MULTI PLAY Setup

Now that you've created your first MULTI PLAY setup — "Jazz Quart" — you'll want to store it to one of the SY55's 16 internal MULTI PLAY memory locations or a memory card location.

- After exiting the edit mode by pressing the [MULTI] key, press the [STORE/COPY] key. The following display will appear:

```
STORE I01
→I01:POP
```

The MULTI PLAY memory number on the top line indicates the source setup — i.e. "Jazz Quart," the setup we just created. The MULTI PLAY number after the arrow on the bottom line is the target setup — i.e. the memory location to which we will store the edited setup.

2. The target memory location can be changed by using the [DATA ENTRY] control, [+1/YES] and [-1/NO] keys, or numeric and [ENTER] keys. The [INTERNAL] and [CARD] keys can be used to change banks, if necessary (obviously you can't store to the read-only PRESET bank, or to a card if no card is loaded).
3. When you're satisfied with the target memory location selection, press [ENTER].

```
STORE I01 Sure?
→I01:POP
```

"Sure?" appears on the top line of the display, asking you to confirm your intention to store to the selected target location. This confirmation step is important because once you store, all previous data in the target location is erased and completely replaced by the new data.

4. Press [+1/YES] to confirm and actually execute the store operation, or [-1/NO] to cancel. "Executing!" will appear on the display during store, and "Completed!" will appear briefly when the store operation is finished.

```
Executing!
```

```
Completed!
```

Your "Jazz Quart" MULTI PLAY setup has now been stored and can be recalled whenever needed!

Note: See the ERROR MESSAGES section on page 144 for information on memory-card related error messages.

Conclusion

If you've gone all the way through this section and followed all the instructions, you've actually done much more than program your first MULTI PLAY setup. You've learnt about many of the most important SY55 programming procedures and, as a result, should find the next tutorial easy to handle.

There are a few functions and features of the MULTI PLAY mode that we haven't looked at in this tutorial. Refer to the "REFERENCE" section for details.

4. RECORDING & PLAYBACK WITH THE SEQUENCER

In the preceding section we learned about the SY55 multi-play mode, and how to create original multi-play setups. In this section we'll see how the SY55 sequencer can be used to record the various parts of a musical composition, and "drive" the corresponding instruments of a multi-play setup. The SY55 sequencer can hold up to 8 separate "songs," each with its own song name ("REFERENCE" section, page 127), that can be selected and recorded or played as required. Completed songs can also be stored to external memory cards for long-term storage ("REFERENCE" section, pages 140 and 141).

The Sequencer/Multi-Play Interface

The SY55 sequencer has 8 separate tracks, each of which can control a separate multi-play instrument. Which track controls which instrument is determined by both the multi-play setup MIDI channel assignments ("REFERENCE" section, page 108) and the sequencer track channel assignments ("REFERENCE" section, page 119). Normally, sequencer tracks 1 through 8 are assigned to the correspondingly numbered MIDI transmit channels, so tracks 1 through 8 control the multi-play instruments assigned to MIDI channels 1 through 8, respectively.

In the example below, preset multi-play setup P01 ("POP") is selected. In the "POP" setup, bass, organ, trumpet and saxophone are assigned to channels 1 through 4, channels 5 through 7 are off, drums are assigned to channel 8, and channels 9 through 16 are off. We therefore have 5 active instruments which will be controlled by the corresponding sequencer tracks.

SY55

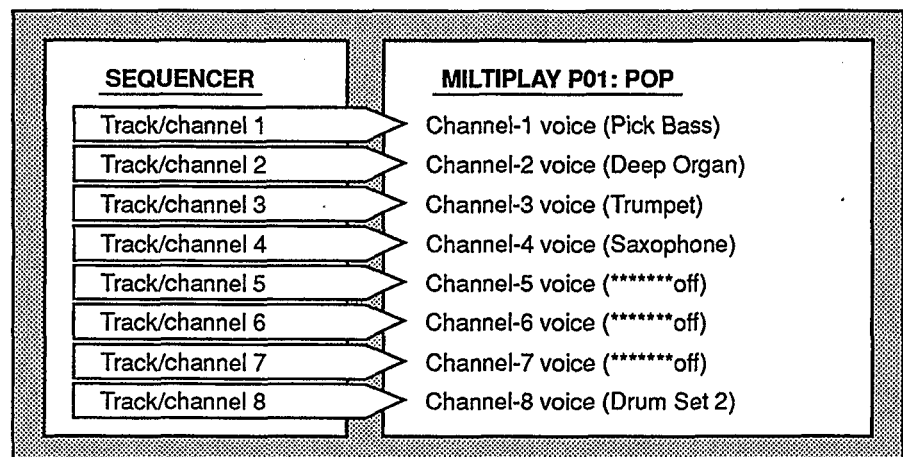

There are basically two ways to record using the sequencer — realtime or step. Both of these methods are described below.

Realtime Recording: Replace & Overdub

Realtime recording allows you to directly record anything you play on the keyboard, capturing the spontaneous timing, keyboard dynamics and controller operations of the performance. Using the realtime recording mode is, in fact, very much like using a conventional tape recorder. Realtime recording is best for parts you can play easily on the keyboard, and for passages in which you want to retain the human "feel" of naturally varying timing and other musical factors.

1. Before recording, press the [MULTI] key and select the multi-play setup you intend to use, then press the [SEQ] key to enter the sequencer mode.
2. At this point you're in the sequencer play mode. The underline cursor will be under the "SONG" (song number) parameter, so you can use the [DATA ENTRY] control, [-1/NO] and [+1/YES] keys, or numeric and [ENTER] keys to select the song number you want to record to (1 through 8).

```
SONG 1:NewSong  
M001 T120 4/ 4
```

3. Press the [RECORD] key. The [RECORD] key indicator will light and a display similar to the following will appear.

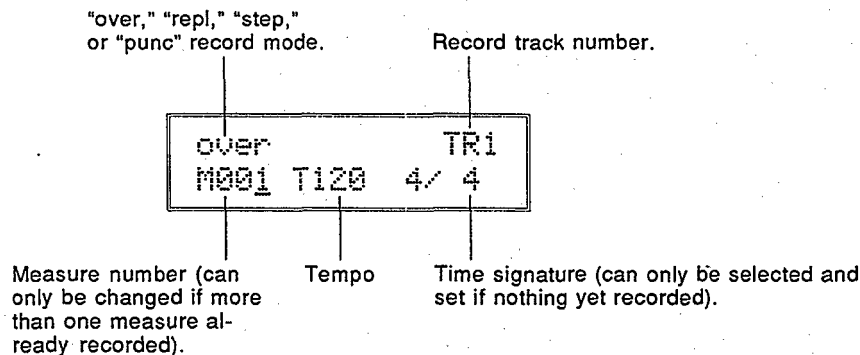

4. Use the [◀] and [▶] keys to move the underline cursor to the parameter in and the upper right-hand corner of the display, and use the [DATA ENTRY] control or [-1/NO] and [+1/YES] keys to select the "repl" (replace) or "over" (overdub) record mode.

The Replace Record Mode

Anything recorded in this mode replaces previously recorded material. That is, previous data on the current track is erased and replaced by the new material.

The Overdub Record Mode

Material recorded in the overdub mode is recorded "over" any previous material, so you end up with a combination of the previous and newly-recorded data.

- If necessary, the tempo, measure, and time signature parameters can also be set at this time. The time signature can only be set if nothing has been recorded in the current song. You can start recording from any measure number within the range of already-recorded measures by setting the measure parameter accordingly. The tempo can be set before recording any track. This is useful because you might want to record complex passages at a slower tempo to minimize mistakes.

Time Signatures

When setting the time signature, the cursor can be moved to the time signature numerator or denominator so that these two values can be set separately. Available time signature ranges are: 1/4 ... 4/4, 1/8 ... 8/8, and 1/16 ... 16/16.

- Select the track you want to record by pressing the appropriate track key (TR1 ... TR8, labelled in green below the numeric keys) while holding the [SELECT] key. A display similar to the following will appear while the [SELECT] key is held.

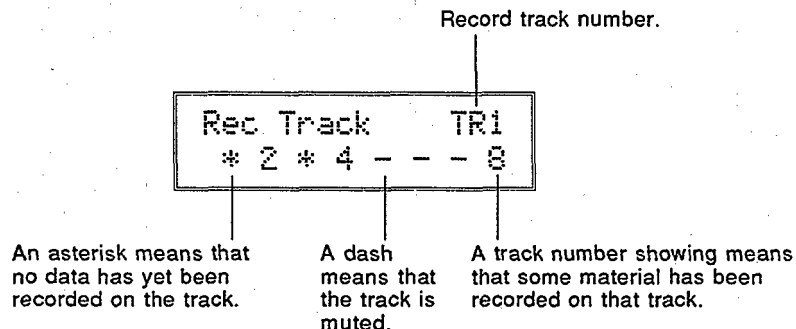

When the desired record track is selected, the corresponding instrument in the current multi-play setup will sound when the keyboard is played.

- Press the [RUN] key and start recording after a two-measure count-in. The count-in is indicated visually on the LCD by "minus" measure numbers — e.g. recording will actually begin after a two-measure count-in from -8 to 0 if 4/4 time is selected, -16 to 0 if 8/8 time is selected, etc. The "click" metronome will also sound as long as the "CLICK SELECT" function is set appropriately ("REFERENCE" section, page 118) and the rear-panel [CLICK VOLUME] control is set to an appropriate level. After the count-in, the measure numbers will increase as recording progresses. The [RUN] key indicator also flashes to indicate the tempo — red on the first beat of every measure and green on all other beats.
- When you have finished playing the part for the current track, press the [STOP] key to stop recording. Both the [RUN] and [RECORD] key indicators will go out, and "Executing!" will appear on the display briefly while recorded data is being processed. After this, the SY55 will return to the sequencer play mode.

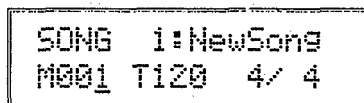

9. You can now listen to the part you've just recorded by pressing the sequencer [◀] key (see illustration below) to return to the first measure, and then the [RUN] key. You can also use the forward and reverse keys to move to any measure and listen to playback from that point.

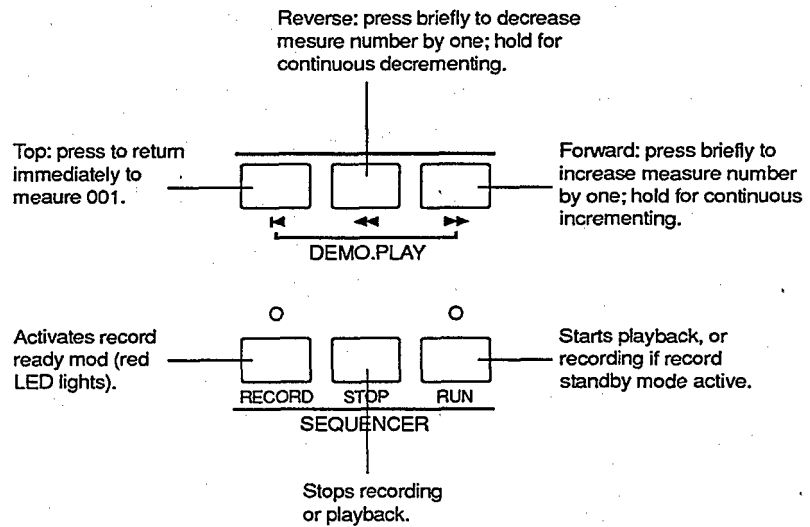

Playback will stop automatically when the end of the recorded sequence is reached, or it can be stopped at any time by pressing the [STOP] key.

10. When you're satisfied that the first track is OK, go back to step 5 and select a new record track, then record. Continue this process until your composition is complete. For difficult tracks you might want to use the step record mode, described on the next page.

Punch-in Recording

Punch-in recording makes it possible to re-record (replace) a section of a previously-recorded track without affecting the data before and after the punch-in section. All operations are the same as for replace recording, except that you must specify the measure numbers for the beginning and end of the punch-in segment. If you select "punc" instead of "over" or "repl," (see step 4, above) the display will appear as follows:

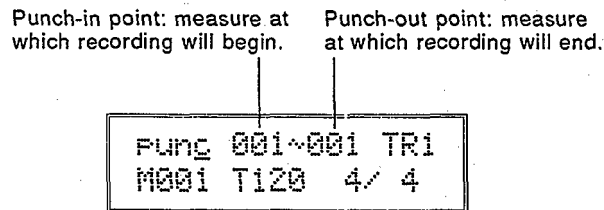

Move the cursor to the punch-in and punch-out point parameters and set as required prior to recording. Other parameters within this display can be set in the same way as for replace or overdub recording.

Once recording is started the sequence will play back until the punch-in point is reached, then the replace record mode will be activated until the punch-out point is reached, allowing you to record the new material. If recorded material exists following the punch-out point, playback will continue until the end of the sequence.

Step Recording

Step recording allows you to input parts note by note, rest by rest, without having to actually play the part on the keyboard. This is ideal for entering difficult parts from written music, or for extremely complex or fast passages that would be impossible to play in real time.

The step recording mode can also be used to edit tracks previously recorded using one of the realtime record modes, allowing you to add or erase notes where necessary.

1. The sequencer and record standby modes are entered in the same way as described in the "REALTIME RECORDING" section, above.
2. Instead of choosing the "repl" or "over" record mode, select "step." You can also select a time signature at this point if nothing has been recorded yet.
3. Press the [RUN] key, to call the step record edit display.

Step write input display line. Each dash represents a 32nd beat. Plus signs mark the beginning of each beat specified by the selected time signature. The example below corresponds to a 1/4 ... 4/4 time signature. If an 8-beat time signature (1/8 ... 8/8) were selected, plus signs would appear every 4 32nd beats. The cursor is placed under the appropriate beat of the display line by using the [←] and [→] cursor keys or the sequence [◀] and [▶] keys to enter notes or rests. The position of the cursor is also reflected by the measure and beat number displays below.

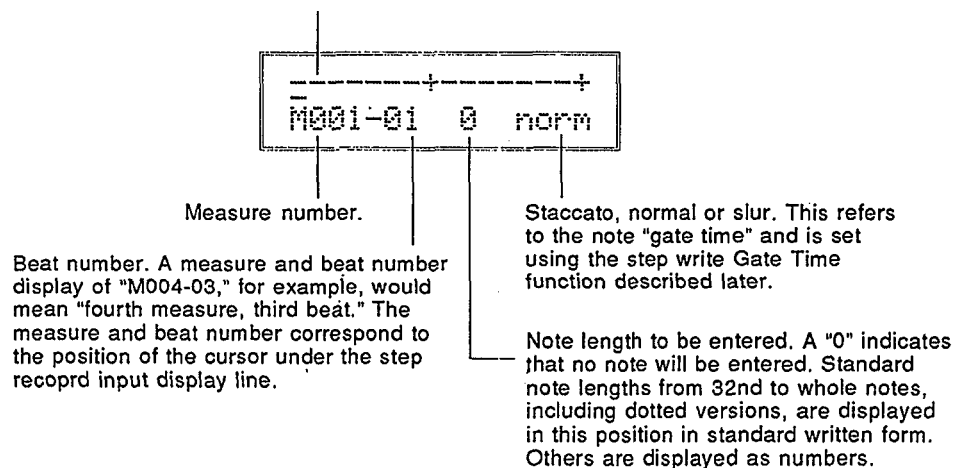

4. Select the note length for the first note by pressing the corresponding numeric key (standard notes are displayed in white above the keys), or by incrementing/decrementing using the [-1/NO] and [+1/YES] keys. The number of 32nd-note segments corresponding to the selected note length will be emphasized on the display. If you select 8th notes in 4/4 time, for example, the display will look something like this:

Four 32nd-notes equal one eighth note.

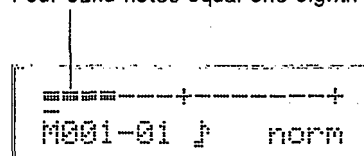

Dotted Notes

Pressing the dot [•] key (numeric key [8]) adds half the value of the currently displayed note length. If this results in a standard note length, it is displayed as a dotted note. Otherwise it is displayed as a numeric value.

Triplets

Triplet-length notes are entered by first selecting the basic note length — e.g. 8th notes if YOU want 8th-note triplets, 16th notes if you want 16-note triplets, etc. — and then the [L3L] key (numeric key [9]). When a note is being displayed “ $\frac{3}{3}$ ” appears to the right of the note, while numeric values are divided by two-thirds (since triplets squeeze three notes in the space normally occupied by two, triplet notes are two-thirds the length of their standard counterparts). You should normally enter triplet notes in groups of 3, 6, 9, 12 or other multiples of 3, in order to end up with standard note lengths.

Ties

Press the [TIE] key (numeric key [-]) immediately after entering a note to tie that note to the next note entered. The tie function is cancelled if you move the cursor between pressing the [TIE] key and entering the second note.

5. When you've selected the required note length, play the note to be entered on the keyboard. The entered note will appear as a diamond (◆) on the step record input display line. The cursor will move to the beginning of the next note.

Entered notes appear as diamonds.

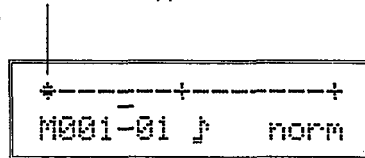

Press the [REST] key (numeric key [0]) instead of playing a note if you

6. Repeat steps 4 and 5 until the required material is entered. You can move the cursor back and forth using the [◀] and [▶] cursor keys or sequencer [◀◀] and [▶▶] keys, adding notes wherever you like — even on top of other notes to create chords.

Erasing Notes

To erase a note, move the cursor to that note and press the [ERASE] key (numeric key [7]). The diamond note marker will disappear. If the diamond marks a chord, the entire chord will be erased.

Staccato and Slurred Notes

Staccato and slurred notes can be entered by using the Gate Time function — press the [PAGE ▶] key while the step record edit display is showing.

```

Gate Time
normal:80%
    
```

Use the [DATA ENTRY] control or [-1/NO] and [+1/YES] keys to select "Staccato:50%," "Normal: 80%," or "Slur:99%." The percentage values are the gate time of the notes. Gate time is the time between the beginning of one note and the beginning of the next. Once the desired gate time has been set, press the [PAGE ◀] key to return to the step record edit display and continue recording.

Switching Voices Mid-track

You can switch to a different voice anywhere in a track by entering a program change command at the required point. After moving the cursor to the point at which you want to change voices in the step record edit display, press the [PAGE ▶] key twice or the [PAGE ◀] key once to select the program change display.

```

Program Change
I P32:Pick.Bass
    
```

Select the desired bank and voice in the normal way, then press the [ENTER] key. The display will return to the step record edit display, and a "p" will occur at the point at which the program change command was entered. Program change commands can be erased in the same way as notes by using the [ERASE] key.

7. Press the [STOP] key to exit the step record mode and return to the sequencer play mode.

Playback

The sequencer play mode is selected anytime you press the [SEQ] key from another mode. The sequencer play display, shown below, allows selection of the song number to play, the measure from which to begin playback, and tempo.

```
SONG 1:NewSong
M001 T120 4/ 4
```

Once the sequencer play mode has been selected, you can use the sequencer [◀◀] and [▶▶] keys to move to any measure from which you want to begin playback, or the [◀] key to move directly to the first measure. The [RUN] key starts playback from the selected measure, and the [STOP] key stops playback at any time.

Track Muting

If you press the [SELECT] key at any time in the sequencer play mode — even while a sequence is playing — the track mute display appears.

```
Track Mute
* 2 * 4 - - - 8
```

An asterisk means that no data has yet been recorded on the track.

A dash means that the track is muted.

A track number showing means that some material has been recorded on that track.

Then, while holding the [SELECT] key, the TR1 through TR8 keys (numeric keys [7], [4], [1], [0], [8], [5], [2], and [-], respectively) can be used to alternately engage or disengage muting for the corresponding track. A dash appears in place of the track number when a track is muted.

Conclusion

Now that you now how to record and play back sequences with the SY55, you'll want to take a look at the "SEQUENCER MODE" information beginning on page 116 of the reference section. There are many important editing and other jobs that have not been described here, but which can make the process of "sequencing" smoother and much more versatile.

5. EDITING VOICES

SY55 Voicing Basics

AWM2 Waveforms

"AWM2" is an acronym for YAMAHA's second-generation 16-bit Advanced Wave Memory. This is a digital waveform storage and reproduction system that rivals the quality of the finest compact disc players, providing unprecedented clarity and realism in the reproduction of acoustic instruments and other natural timbres. Technically speaking, AWM2 deals with 16-bit wave data sampled at 32 or 48 kilohertz, 24-bit internal signal processing, and high-resolution 22-bit digital-to-analog converters.

The SY55 contains 2 megabytes of of sampled waveform ROM, so you have a choice of 74 built-in waveforms from which to construct voices.

● PRESET WAVE LIST

No.	Name	No.	Name	No.	Name	No.	Name
1	Piano	21	GtrSteel	41	Digital2	61	BD 3
2	E.Piano1	22	Gtr Gut	42	Digital3	62	SD 1
3	E.Piano2	23	12string	43	Pulse 10	63	SD 2
4	E.Piano3	24	E.Guitar	44	Pulse 25	64	SD 3
5	E.Piano4	25	E.Bass	45	Pulse 50	65	Rim
6	E.Piano5	26	Popping	46	Tri	66	Tom 1
7	E.Piano6	27	WoodBass	47	Voice	67	Tom 2
8	E.Piano7	28	Syn Bass	48	Piano Np	68	HHclosed
9	Harpsi	29	Violin	49	EPianoNp	69	HH open
10	Organ 1	30	Strings	50	Vibe Np	70	Crash
11	Organ 2	31	Chorus	51	Bottle	71	Ride
12	Pipe	32	Itopia	52	Tuba	72	Claps
13	Trumpet	33	Vibe	53	Vocal Ga	73	Cowbell
14	Mute Tp	34	Marimba	54	Bamboo	74	Shaker
15	Trombone	35	Glocken	55	Noise		
16	Flugel	36	Shamisen	56	Styroll		
17	Sax	37	Harp	57	Bulb		
18	Flute	38	Mtl Reed	58	Bell Mix		
19	Brass	39	Saw	59	BD 1		
20	SynBrass	40	Digital1	60	BD 2		

Elements and Voice Architecture

Each SY55 voice is composed of one, two or four "elements." The only limitation is that the maximum polyphony of the SY55 is 16 (i.e. the maximum number of notes that can be played simultaneously is 16). This means that a 1-element voice can produce the full 16 notes, while a "layered" 2-element voice can produce 8, and a layered 4-element voice can produce 4.

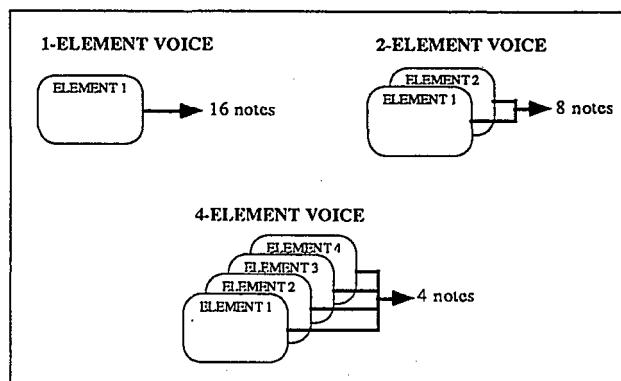

Each element can be assigned an AWM2 waveform from the 74 provided in internal ROM, or others available on plug-in waveform cards. You can have a single element voice that uses only a single waveform, or multi-element voices that combine two or four different waveforms in a number of ways. Each element has its own programmable 5-segment amplitude envelope generator so you can "layer" waveforms enveloped in different ways to create any number of unique sonic hybrids. See page 64 of the "REFERENCE" section for a full description of the amplitude envelope generator parameters.

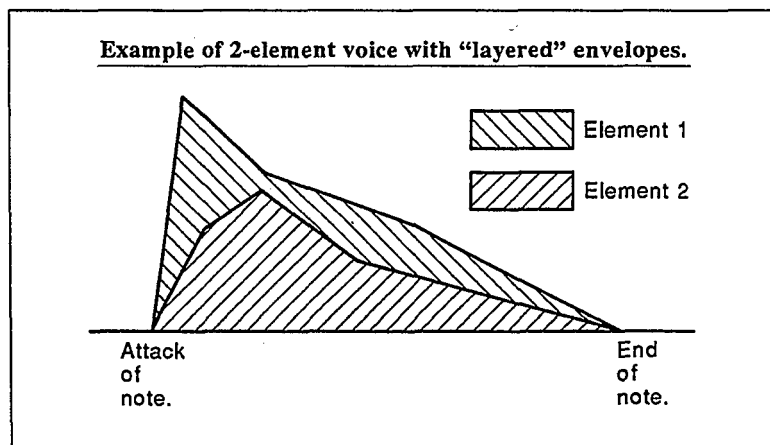

As an alternative to layering elements, each element can be assigned to a different section of the keyboard for exotic split keyboard setups using the low and high-note limit functions described on page 60 of the "REFERENCE" section.

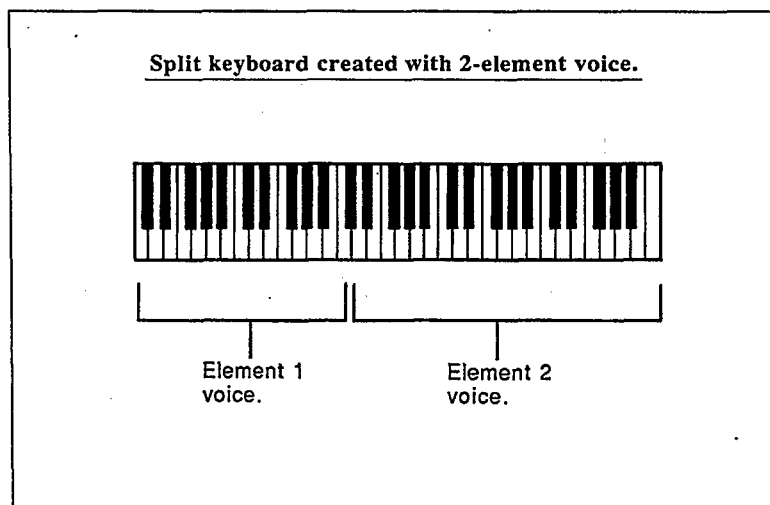

Each element also has a pitch envelope generator and two filter cutoff envelope generators that control the SY55's innovative digital filter system. The block diagram below shows how the various operational blocks within each element are interconnected.

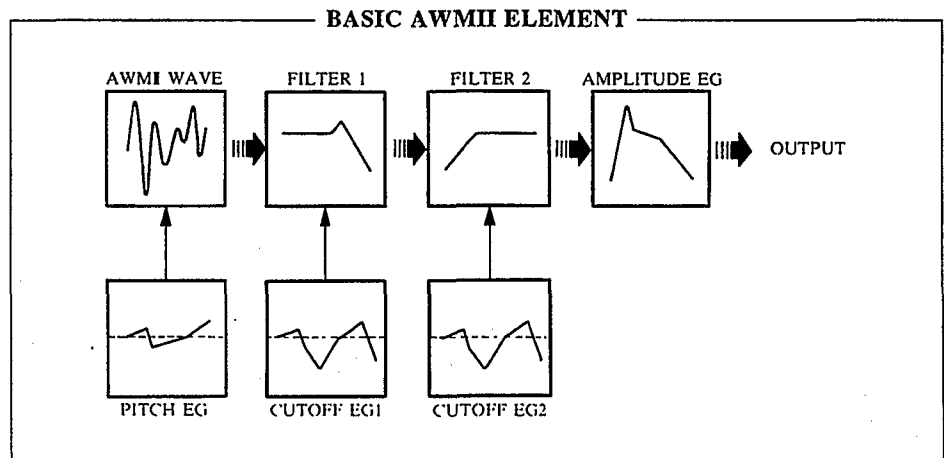

Digital Filters

Each element has two digital filters. Filter 1 (FL1) is switchable for either low-pass or high-pass response, while Filter 2 (FL2) is a low-pass type. Each filter has its own 6-segment envelope generator so that a virtually unlimited range of dynamic filtering patterns can be produced. See page 63 of the "REFERENCE" section for details on the filter cutoff envelope generators. Filter cutoff can also be controlled by the element's LFO (low-frequency oscillator).

Low-pass and high-pass filters can be combined to create a bandpass response, or both filters can be set for low-pass operation — each with a rolloff slope of 12-dB/octave — to produce a steep 24-dB/octave low-pass curve. The filters also have a resonance parameter in the low-pass mode that allows you to boost their cutoff-frequency peak — all the way into oscillation if you like. The following graphs show the types of filter response that can be achieved.

Filter Response Examples

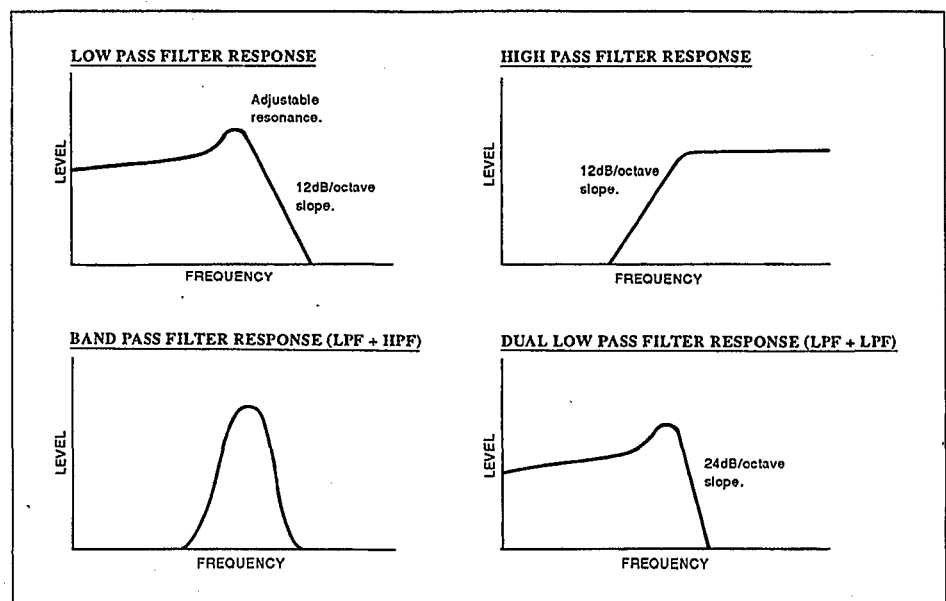

Other Programmable Parameters & Effects

For each element in any voice you can also control volume, note shift, detuning, high and low note limits, high and low velocity limits for velocity-switched keyboard dynamics, pan position, LFO modulation, controller assignments and more. Of course, the standard pitch and modulation wheels perform their familiar functions, but you can also assign any MIDI controller to amplitude modulation, pitch modulation, filter cutoff modulation, direct filter cutoff control, envelope generator bias and volume ... not to mention after-touch pitch bias ("REFERENCE" section, pages 81 through 84).

You also have direct access to 34 digital effect programs including reverb, delay, early reflection, tone control and distortion — each with several programmable parameters. See page 86 of the "REFERENCE" section for details on the effects and their various parameters.

SY55 Effects

1: Rev.Hall	(Reverb Hall)
2: Rev.Room	(Reverb Room)
3: RevPlate	(Reverb Plate)
4: RevChrch	(Reverb Church)
5: Rev.Club	(Reverb Club)
6: RevStage	(Reverb Stage)
7: BathRoom	(Reverb Bath Room)
8: RevMetal	(Reverb Metal)
9: Delay	(Single Delay)
10: DelayL/R	(Stereo Delay)
11: St.Echo	(Stereo Echo)
12: Doubler1	(Single Doubler)
13: Doubler2	(Stereo Doubler)
14: PingPong	(Ping Pong Delay)
15: Pan Ref.	(Pan Reflections)
16: EarlyRef	(Early Reflections)
17: Gate Rev	(Gate Reverb)
18: Rvs Gate	(Reverse Gate)
19: FB E/R	(Feedback Early Reflections)
20: FB Gate	(Feedback Gate)
21: FB Rvs	(Feedback Reverse)
22: Dly1&Rev	(Delay 1 & Reverb)
23: Dly2&Rev	(Delay 2 & Reverb)
24: Tunnel	(Tunnel Reverb)
25: Tone 1	(Tone Control 1)
26: Dly1&T1	(Delay 1 & Tone Control 1)
27: Dly2&T1	(Delay 2 & Tone Control 1)
28: Tone 2	(Tone Control 2)
29: Dly1&T2	(Delay 1 & Tone Control 2)
30: Dly2&T2	(Delay 2 & Tone Control 2)
31: Dist&Rev	(Distortion & Reverb)
32: Dst&Dly1	(Distortion & Delay 1)
33: Dst&Dly2	(Distortion & Delay 2)
34: Dist.	(Distortion)

SY55 Voice Parameter Chart

The voice parameter chart on the following page lists all of the programmable voice parameters — titled as they appear on the SY55 editing screen. You might want to make copies of this chart in order to jot down parameters as you program your own voices.

SY55 Voice Parameter Chart.

Voice Name:

	EL1	EL2	EL3	EL4		EL1	EL2	EL3	EL4
VOICE Mode					FL1\CEG L3				
Wave Select					FL1\CEG R4				
Volume					FL1\CEG L4				
Note Shift					FL1\CEG RR1				
Detune					FL1\CEG RL1				
Note Limit/L					FL1\CEG RR2				
Note Limit/H					FL1\CEG RL2				
Vel. Limit/L					FL1\R.Scale				
Vel. Limit/H					FL1\LS BP1				
Pan					FL1\LS BP2				
EF Balance					FL1\LS BP3				
OSC Frq.Mode					FL1\LS BP4				
OSC Frq.Note					FL1\LS OFS1				
OSC Frq.Tune					FL1\LS OFS2				
AEG Mode					FL1\LS OFS3				
AEG R1/HT					FL1\LS OFS4				
AEG R2					FL2\Type				
AEG L2					FL2\Cutoff				
AEG R3					FL2\Mode				
AEG L3					FL2\CEG L0				
AEG R4					FL2\CEG R1				
AEG RR					FL2\CEG L1				
AEG R.Scale					FL2\CEG R2				
AEG LS BP1					FL2\CEG L2				
AEG LS BP2					FL2\CEG R3				
AEG LS BP3					FL2\CEG L3				
AEG LS BP4					FL2\CEG R4				
AEG LS OFS1					FL2\CEG L4				
AEG LS OFS2					FL2\CEG RR1				
AEG LS OFS3					FL2\CEG RL1				
AEG LS OFS4					FL2\CEG RR2				
Sens. Vel.					FL2\CEG RL2				
Sens. V.Rate					FL2\R.Scale				
Sens. AMS					FL2\LS BP1				
Sens. PMS					FL2\LS BP2				
LFO Wave					FL2\LS BP3				
LFO Speed					FL2\LS BP4				
LFO Delay					FL2\LS OFS1				
LFO Phase					FL2\LS OFS2				
LFO AMOD					FL2\LS OFS3				
LFO PMOD					FL2\LS OFS4				
LFO CutoffMOD					FL\Resonance				
PEG L0					FL\Vel.Sens				
PEG R1					FL\Mod.Sens				
PEG L1					CNTL\Pitch Bend				
PEG R2					CNTLAT P.Bias				
PEG L2					CNTL\RandomPitch				
PEG R3					CNTL\AMOD CTL#				
PEG L3					CNTL\AMOD RNG				
PEG RR					CNTL\PMOD CTL#				
PEG RL					CNTL\PMOD RNG				
PEG Range					CNTL\CoffMOD CTL#				
PEG R.Scale					CNTL\CoffMOD RNG				
PEG Vel.SW					CNTL\Cutoff CTL#				
FL1\Type					CNTL\Cutoff RNG				
FL1\Cutoff					CNTL\EG Bias CTL#				
FL1\Mode					CNTL\EG Bias RNG				
FL1\CEG L0					CNTL\Volume CTL#				
FL1\CEG R1					CNTL\Volume MIN				
FL1\CEG L1					EFType				
FL1\CEG R2					EFOutput Level				
FL1\CEG L2					EF\ ** Others **				
FL1\CEG R3									

SY55 Voice Parameter Chart.

Voice Name: VeloChorus

	EL1	EL2	EL3	EL4		EL1	EL2	EL3	EL4
VOICE Mode	2 Element				FL1\CEG L3	0	0		
Wave Select	P31	P56			FL1\CEG R4	0	0		
VOLUME	127	100			FL1\CEG L4	0	0		
Note Shift	0	0			FL1\CEG RR1	0	0		
Detune	0	0			FL1\CEG RL1	0	0		
Note Limit/L	C-2	C-2			FL1\CEG RR2	0	0		
Note Limit/H	G8	G8			FL1\CEG RL2	0	0		
Vel. Limit/L	1	55			FL1\R.Scale	0	0		
Vel. Limit/H	127	127			FL1\LS BP1	C1	C1		
Pan	0	0			FL1\LS BP2	G2	G2		
EF Balance	50	60			FL1\LS BP3	E4	E4		
OSC Frq. Mode	norm	norm			FL1\LS BP4	C6	C6		
OSC Frq. Note	—	—			FL1\LS OFS1	0	0		
OSC Frq. Tune	0	0			FL1\LS OFS2	0	0		
AEG Mode	norm	norm			FL1\LS OFS3	0	0		
AEG R1/HT	30	63			FL1\LS OFS4	0	0		
AEG R2	37	12			FL2>Type	THU	THU		
AEG L2	59	50			FL2\Cutoff	127	127		
AEG R3	28	30			FL2\Mode	LFO	LFO		
AEG L3	54	47			FL2\CEG L0	—	—		
AEG R4	0	0			FL2\CEG R1	—	—		
AEG RR	30	30			FL2\CEG L1	—	—		
AEG R.Scale	0	0			FL2\CEG R2	—	—		
AEG LS BP1	C1	C1			FL2\CEG L2	—	—		
AEG LS BP2	G2	G2			FL2\CEG R3	—	—		
AEG LS BP3	E4	E4			FL2\CEG L3	—	—		
AEG LS BP4	C6	C6			FL2\CEG R4	—	—		
AEG LS OFS1	0	0			FL2\CEG L4	—	—		
AEG LS OFS2	0	0			FL2\CEG RR1	—	—		
AEG LS OFS3	0	0			FL2\CEG RL1	—	—		
AEG LS OFS4	0	0			FL2\CEG RR2	—	—		
Sens. Vel.	0	0			FL2\CEG RL2	—	—		
Sens. V.Rate	off	off			FL2\R.Scale	—	—		
Sens. AMS	0	0			FL2\LS BP1	C1	C1		
Sens. PMS	2	0			FL2\LS BP2	G2	G2		
LFO Wave	tri	tri			FL2\LS BP3	E4	E4		
LFO Speed	57	65			FL2\LS BP4	C6	C6		
LFO Delay	70	0			FL2\LS OFS1	0	0		
LFO Phase	0	0			FL2\LS OFS2	0	0		
LFO AMOD	0	0			FL2\LS OFS3	0	0		
LFO PMOD	0	0			FL2\LS OFS4	0	0		
LFO CutoffMOD	0	0			FL\Resonance	3	0		
PEG L0	-15	-22			FL\Vel.Sens	0	0		
PEG R1	60	40			FL\Mod.Sens	0	0		
PEG L1	0	0			CNTL\Pitch Bend	2			
PEG R2	63	63			CNTL\AT P.Bias	0			
PEG L2	0	0			CNTL\RandomPitch	0			
PEG R3	63	63			CNTL\AMOD CTL#	12			
PEG L3	0	0			CNTL\AMOD RNG	64			
PEG RR	63	63			CNTL\PMOD CTL#	1			
PEG RL	0	0			CNTL\PMOD RNG	64			
PEG Range	2 oct	2 oct			CNTL\CoffMOD CTL#	1			
PEG R.Scale	0	0			CNTL\CoffMOD RNG	0			
PEG Vel.SW	off	off			CNTL\Cutoff CTL#	12			
FL1\Type	LPF	LPF			CNTL\Cutoff RNG	0			
FL1\Cutoff	114	127			CNTL\EG Bias CTL#	2			
FL1\Mode	EG	EG			CNTL\EG Bias RNG	0			
FL1\CEG L0	-20	0			CNTL\Volume CTL#	14			
FL1\CEG R1	27	16			CNTL\Volume MIN	0			
FL1\CEG L1	0	-18			EF\Type	1: Rev.Hall			
FL1\CEG R2	0	0			EF\Output Level	100%			
FL1\CEG L2	0	0			EF\ ** Others **	Time 2.6 / LPF 8.0 / Delay 29			
FL1\CEG R3	0	0							

Programming the "VeloChorus" Voice

Now that you've got the basic idea, try programming the VeloChorus voice described below. VeloChorus is a 2-element voice in which the "Chorus" waveform is assigned to element 1 and the "Styroll" waveform is assigned to element 2. Both waveforms are enveloped and filtered, and the Styroll waveform is "velocity switched" so it only appears — layered onto the chorus sound — when you play the keys on your keyboard quite hard.

Here's the Voice Parameter Chart for the VeloChorus voice.

The changes are made in "real time" as you program. So don't be afraid to play the voice via your keyboard/controller as you program, to hear the sound as it gradually takes shape.

1. If it is not already selected, press [VOICE] to select the VOICE PLAY mode.
2. Use the [INTERNAL], [-1/NO] and [+1/YES] keys to select VOICE I01.

```
VOICE PLAY
I01 Piano
```

3. Press [EDIT/COMPARE] to enter the VOICE EDIT mode.
4. Press the [JOB] key, the numeric [4] and [2] keys, and then the [ENTER] key to select voice edit job 42: Voice Initialize.

```
VOICE
Initialize
```

5. The voice initialize function allows us to create an "initialized" voice in which all parameters are set to their "standard" values. This is useful because the controller parameters — i.e. pitch wheel and modulation wheel — are also set to function normally, so we won't have to go to the trouble to program these particular parameters for this example ("REFERENCE" section, page 90).

Press the [ENTER] key.

```
VOICE      Sure?
Initialize
```

"Sure?" appears on the top line of the display, asking you to confirm your intention to initialize the voice. Press [+1/YES] to confirm and actually execute the initialize operation. "Completed!" will appear briefly when the initialization is finished.

```
Completed!
```

6. Press the [PAGE ►] key once to move ahead to the VOICE Mode job ("REFERENCE" section, page 58).

```
VOICE Mode
  =1 Element
```

7. Press the [+1/YES] key to change "=1 Element" to "=2 Element". This selects the 2-element voice configuration (the [-1/NO] and [+1/YES] keys are just one means of changing the value of a selected parameter in the edit modes — "REFERENCE" Section, page 53).

```
VOICE Mode
  =2 Element
```

8. Press the [PAGE ►] key once to move ahead the AWM Wave Selection job ("REFERENCE" section, page 58).

```
<Tri    >  EL1
#P46 P46 *** ***
```

9. When the 2-element mode is selected (as it should be after the last step), element 1 (EL1) and element 2 (EL2) are available and a different waveform from among the SY55's 74 preset waveforms can be assigned to each. The unavailable elements are represented by "***" on the display.

The [◀] and [▶] cursor keys are used to move the cursor to the desired element (EL1 or EL2 will appear in the upper right-hand corner of the display), and the [DATA ENTRY] control, [+1/YES] and [-1/NO] keys, or numeric and [ENTER] keys are used to assign the desired wave to the selected element. The selected wave number is shown at the current cursor location, and the full name of the assigned wave is shown in the upper left-hand corner of the display.

- With the cursor at the EL1 position, select the P31 (Chorus) waveform.
- Move the cursor to the EL2 position by pressing [▶], then select the P56 (Styroll) waveform.

```
<Chorus >  EL1
#P31 P56 *** ***
```

10. Press the [PAGE ►] key to move to the Volume job ("REFERENCE" section, page 47).

```
Volume 127  EL1
#127 127 *** ***
```

11. The volume job operates in basically the same way as the voice assignment job described above. The [◀] and [▶] cursor keys are used to select the element for which the volume is to be adjusted, then the [DATA ENTRY] control, [+1/YES] and [-1/NO] keys, or numeric and [ENTER] keys are used to set the desired volume. A setting of "0" produces no sound while a setting of "127" produces maximum volume.

For the VeloChorus voice, leave the Chorus volume setting at the maximum of 127, and lower the Styroll setting to about 100.

```

Volume 127  EL1
#127 100 *** **
    
```

12. Press the [JOB] key, the numeric [8] key, and then the [ENTER] key to select the Vel. Limit/L job ("REFERENCE" section, page 61). We'll skip the Note Shift ("REFERENCE" section, page 59), Detune, and Note Limit ("REFERENCE" section, page 60) jobs for this voice, since we don't need to detune or transpose the pitch of either of the waveforms in the VeloChorus voice, or set note limits to create a split keyboard setup.

```

Vel. Limit/L EL1
# 1 1 *** **
    
```

13. The Velocity Limit job is where we setup the VeloChorus voice's interesting velocity switching feature. This job lets us set the lowest velocity value for a range of velocity values over which the element will produce output. A little more explanation is in order:

Every MIDI "note on message" (the MIDI message that is transmitted every time a note is played on a keyboard or other MIDI controller) contains a "velocity" value that tells the tone generator how hard the note has been played. The range of MIDI velocity values is from 1 to 127 — thus the 1 ... 127 range of this function. By setting the low velocity limit of the Styroll element to about "55", the Styroll portion of the voice will only sound when a key is played hard enough to transmit a velocity value greater than 55. The low velocity limit of the Chorus waveform is left at "1" so that the Chorus element sounds no matter how hard or soft you play the keys.

You should be getting quite familiar with the basic procedure by now: the [◀] and [▶] cursor keys are used to select the element for which the low velocity limit is to be set, and the [DATA ENTRY] control, [+1/YES] and [-1/NO] keys, or numeric and [ENTER] keys are used to set the low velocity limit.

14. Next select job 11: EF Balance ("REFERENCE" section, page 63), skipping the Vel. Limit/H ("REFERENCE" section, page 62) and Pan ("REFERENCE" section, page 62).

```

EF Balance  EL1
# 0 0 *** **
    
```

15. Set the EF Balance (Effect Balance) for EL1 and EL2 as follows:

EL1 (Chorus)50
EL2 (Styroll)60

16. Select job 13: Amplitude EG ("REFERENCE" section, page 64), skipping the OSC Frq.Mode ("REFERENCE" section, page 63) display.

17. Here we program the amplitude envelope generators for EL1 and EL2 — and learn a new element selection technique.

```

AEG Mode      EL1
nrp  63  63  63+
```

Element Selection: If you press and hold the [SELECT] key the element selection and switching display will appear.

```

SELECT  FL1  EL1
        1   2   *  *
```

On the upper display line "FL1" indicates that Filter 1 is selected and "EL1" indicates that Element 1 is selected. The lower display line indicates that the 2-element mode has been selected (elements 1 and 2 are active). The asterisks (*) indicate elements that are not available (3 and 4 in this case).

While the [SELECT] key is held, any of the available elements can be selected by pressing the corresponding [EL SEL] key (note the green markings next to the numeric [7], [4], [1] and [0] keys).

Also while the [SELECT] key is pressed, any of the available elements can also be turned ON or OFF (usually to hear how a single element in a multiple-element voice sounds) by pressing the corresponding [EL ON/OFF] key (the numeric [8], [5], [2] and [-] keys). An available element that has been turned OFF in this manner appears as a "-" on the display.

Releasing the [SELECT] key returns the display to the current job.

You know how to select elements, select parameters using the [◀] and [▶] keys, and change values using the [DATA ENTRY] control or [-1/NO] and [+1/YES] keys, so go ahead and program the various amplitude envelope generator parameters for each element as follows:

Hint: The arrow symbols (← and →) that appear at either end of the display mean that more parameters can be accessed by moving the cursor in the indicated direction using the [◀] and [▶] keys.

18. Use the [PAGE▶] key to step through the next eight jobs yourself while referring to the VeloChorus Voice Chart on the previous page, checking all parameters and making adjustments when necessary.

Parameter	E1 (Chorus)	E2 (Styroll)
AEG Mode	nrm	nrm
AEG R1 (Rate 1)	30	63
AEG R2 (Rate 2)	37	12
AEG L2 (Level 2)	59	50
AEG R3 (Rate 3)	28	30
AEG L3 (Level 3)	54	47
AEG R4 (Rate 4)	0	10
AEG RR (Release Rate)	30	30

19. When you get to this display:

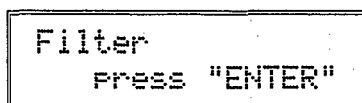

It's time to learn a new technique.

The filter functions can be accessed by pressing the [ENTER] key from the above display —just like it says on the screen. Once you're "in" the filter function subset, you can move around using the [PAGE ◀] and [PAGE ▶] keys just as you can anywhere else. When you're finished with the filter function subset, return to the main function set by pressing the [EXIT] key.

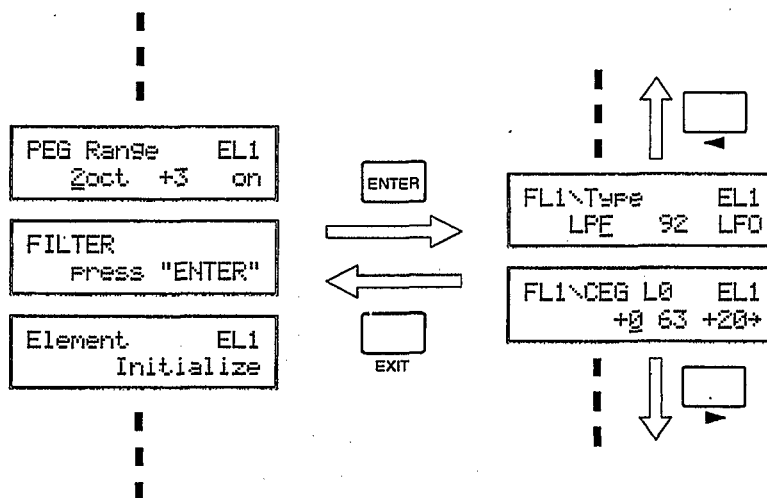

Of course you can also access any of the filter jobs by pressing the [JOB] key and entering the appropriate job number.

The filter 1 or filter 2 envelope generator can be selected by holding the [SELECT] key and pressing the numeric [9] or [6] key, respectively (this operation will also take you directly to the filter functions from anywhere within the voice edit mode).

Now that you're in the filter function subset; go ahead and program the filter parameters, referring to the VeloChorus voice parameter chart on page 40.

20. Next select job 40: Voice Name ("REFERENCE" section, page 89). Here we'll give our original voice a name: "VeloChorus".
21. The VOICE Name job allows a name of up to 10 characters to be assigned to the current voice. Use the [←] and [→] cursor keys to place the underline cursor under the character to be changed, then use the [DATA ENTRY] control or [+1/YES] and [-1/NO] keys to select the desired character. Continue until the entire voice name has been programmed.

```
VOICE Name
      "INIT VOICE"
```

22. Press [VOICE] to exit from the edit mode and return to the VOICE mode. The reversed letter "E" that appears to the right of the voice number indicates that the voice has been edited.

Caution!!: If you select a different voice or mode at this point, the edited voice will be erased. To keep an edited voice, it must be stored to an INTERNAL or CARD memory location, as described in the following section. For a special method of recalling a voice lost in this way, see "VOICE RECALL" on page 89.

Storing an Edited Voice

Now that you've created your first original voice — "VeloChorus" — you'll want to store it to one of the SY55's 64 internal voice memory locations or a memory card location.

1. After exiting the edit mode by pressing the [VOICE] key, press the [STORE/COPY] key. The following display will appear:

```
STORE I01
      ↗I01:Piano
```

The voice number on the top line indicates the source setup — i.e. the "VeloChorus" voice we just created in the SY55's edit buffer memory. The voice number after the arrow on the bottom line is the target voice — i.e. the memory location to which we will store the edited voice.

2. The target memory location can be changed by using the [DATA ENTRY] control, [-1/NO] and [+1/YES] keys, or numeric and [ENTER] keys. The [INTERNAL] and [CARD] keys can be used to change banks, if necessary (obviously you can't store to the read-only PRESET bank, or to a card if no card is loaded).

Note: If you intend to store the voice to a memory card, make sure that the card has been properly formatted ("REFERENCE" section, page 138), and that the card's WRITE PROTECT switch is turned OFF (refer to the MCD64 or MCD32 Memory Card instructions for details).

3. When you're satisfied with the target memory location selection, press [ENTER].

```
STORE I01  Sure?
→I01:Piano
```

"Sure?" appears on the top line of the display, asking you to confirm you intention to store to the selected target location. This confirmation step is important because once you store, all previous data in the target location is erased and completely replaced by the new data.

4. Press [+1/YES] to confirm and actually execute the store operation, or [-1/NO] to cancel. "Executing!" will appear on the display during store, and "Completed!" will appear briefly when the store operation is finished.

```
Completed!
```

Your "VeloChorus" voice has now been stored and can be recalled whenever needed!

Note: Refer to the "ERROR MESSAGES" section on page 144 for information on memory-card related error messages.

Conclusion

Well that's about it. You've learned the basics of getting around in the SY55's play and edit modes. Be sure to read the "General Operation" sections in the reference section for more important operating techniques. The voice edit mode, for example, offers element, AEG and effect copy functions that can make the job of programming voices much faster and more efficient.

If you've carefully gone through all five tutorials, you should now be able to handle just about any SY55 job simply by referring to the reference section.

VOICE EDIT MODE

VOICE EDIT MODE

VOICE EDIT MODE

VOICE EDIT MODE

VOICE EDIT MODE

REFERENCE SECTION

VOICE EDIT MODE

Contents

GENERAL OPERATION	52
Selecting the Voice Edit Mode	52
Selecting the Various Edit Mode Jobs	52
Selecting and Editing Parameter Values	53
Selecting an Element to Edit/Element ON-OFF Switching	54
Edit/Compare Operation	54
The Element, AEG and Filter Copy Functions	55
The Effect Copy Function	56
JOBS & PARAMETERS	58
VOICE MODE	58
AWM WAVE SELECTION	58
VOLUME	59
NOTE SHIFT	59
DETUNE	60
LOW NOTE LIMIT	60
HIGH NOTE LIMIT	61
LOW VELOCITY LIMIT	61
HIGH VELOCITY LIMIT	62
PANNING	62
EFFECT BALANCE	63
OSCILLATOR MODE/NOTE/TUNE	63
AMPLITUDE ENVELOPE GENERATOR (AEG) MODE/LEVEL/RATE	64
AMPLITUDE ENVELOPE GENERATOR (AEG) RATE SCALING	66
AMPLITUDE ENVELOPE GENERATOR (AEG) LEVEL SCALE BREAKPOINT	66
AMPLITUDE ENVELOPE GENERATOR (AEG) LEVEL SCALE OFFSET	66
SENSITIVITY (VELOCITY, AMPLITUDE & PITCH MODULATION)	67
LOW FREQUENCY OSCILLATOR (LFO) WAVEFORM/SPEED/DELAY/PHASE	69
LOW FREQUENCY OSCILLATOR (LFO) MODULATION DEPTH, AMPLITUDE/PITCH/CUTOFF	70

PITCH ENVELOPE GENERATOR (PEG) LEVEL/RATE	71
PITCH ENVELOPE GENERATOR (PEG) SENSITIVITY, RANGE/RATE SCALING/VELOCITY SWITCH	72
FILTER: TYPE/CUTOFF/MODE	73
FILTER: CUTOFF ENVELOPE GENERATOR	75
FILTER: RATE SCALING	76
FILTER: LEVEL SCALING BREAKPOINT	76
FILTER: LEVEL SCALING OFFSET	77
FILTER: RESONANCE/VELOCITY SENSITIVITY/ MODULATION SENSITIVITY	77
ELEMENT INITIALIZE	79
CONTROLLER: PITCH BEND RANGE	81
CONTROLLER: AFTER TOUCH PITCH BIAS	81
CONTROLLER: RANDOM PITCH RANGE	81
CONTROLLER: AMPLITUDE MODULATION	82
CONTROLLER: PITCH MODULATION	82
CONTROLLER: CUTOFF MODULATION	83
CONTROLLER: CUTOFF FREQUENCY CONTROL	83
CONTROLLER: EG BIAS CONTROL	84
CONTROLLER: VOLUME CONTROL	84
EFFECT: TYPE/OUTPUT LEVEL	85
EFFECT: EFFECT PARAMETERS	86
VOICE NAME	89
VOICE RECALL	89
VOICE INITIALIZE	90

GENERAL OPERATION

Selecting the Voice Edit Mode

Press the [VOICE] key followed by the [EDIT/COMPARE] key. Both the [VOICE] and [EDIT/COMPARE] key indicators should be lit.



If the VOICE PLAY mode is already selected (i.e. the [VOICE] key indicator is lit), it is only necessary to press the [EDIT/COMPARE] key.

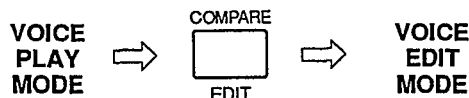

You can exit the voice edit mode and return to the voice play mode at any time by pressing either the [VOICE] key or the [EXIT] key.

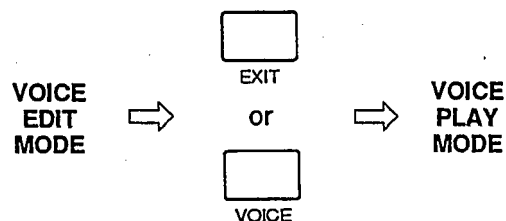



Selecting the Various Edit Mode Jobs

Once the voice edit mode has been selected, two different methods can be used to select the various voice editing jobs.

Method 1: Page Access.

The [PAGE ◀] and [PAGE ▶] keys can be used to scroll forward and backward through the editing jobs.

- 
- To step forward through the voice edit job list.
 - Hold for continuous scrolling.
- 
- To step backward through the voice edit job list.
 - Hold for continuous scrolling.

In some cases a display screen accessed by the [PAGE ◀] and [PAGE ▶] keys will actually be a "doorway" to a separate list of jobs relating to that function. In the voice edit mode, the FILTER, CONTROLLER and EFFECT jobs are of this type. When

"Filter" is selected, for example, "press ENTER" will appear on the bottom line of the display.

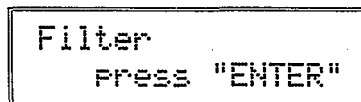

When you press [ENTER], the [PAGE ◀] and [PAGE ▶] keys can be used to access a whole subset of FILTER jobs. When you're finished editing filter jobs, press the [EXIT] key to return to the primary job list.

Method 2: Direct Job Number Entry.

All edit mode jobs have a "job number." These are listed along with the job names throughout the reference section of this manual. Any editing job can be directly accessed by first pressing the [JOB] key, and then selecting the desired job number using the [DATA ENTRY] control, the [-1/NO] and [+1/YES] keys, or the numeric and [ENTER] keys.

When the [JOB] key is pressed, the job selection display appears showing the currently selected job.

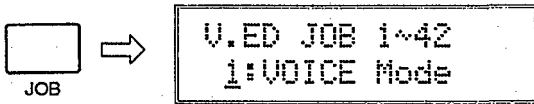

On the upper display line "V.ED JOB 1-42" means that you are in the voice edit mode (V.ED) and that you have a choice of jobs 1 through 42 (JOB 1-42).

You can now select the desired job number by using the [DATA ENTRY] control/the [-1/NO] and [+1/YES] keys, or the numeric keys.

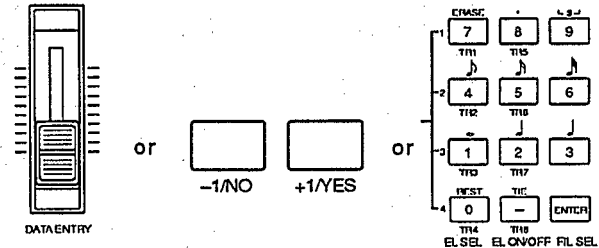

• To select the desired job number.

If you use the numeric keys, the entered number will flash on the display. Confirm that the desired job name appears on the display, then press the [ENTER] key to go directly to the selected job.

Selecting and Editing Parameter Values

Some jobs only have a single parameter, while others contain several that must be selected using the [◀] and [▶] cursor keys. In many cases the [◀] and [▶] keys are used to select one of the available elements in a multi-element voice.

The value of a selected parameter is adjusted using the [DATA ENTRY] control, the [-1/NO] and [+1/YES] keys, or the numeric and [ENTER] keys.

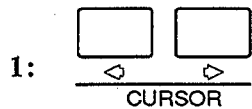

• To select desired element or parameter.

When using the numeric keys, first enter the desired value in one, two, or three digits (the value will flash on the display), then press the [ENTER] key (the value will stop flashing). In general, if you enter a value higher than the maximum value or lower than the minimum value for the selected parameter, the maximum or minimum value will be selected, respectively, when the [ENTER] key is pressed. The numeric [-] key can be used to make positive values negative, and vice versa, for parameters which accept negative values.

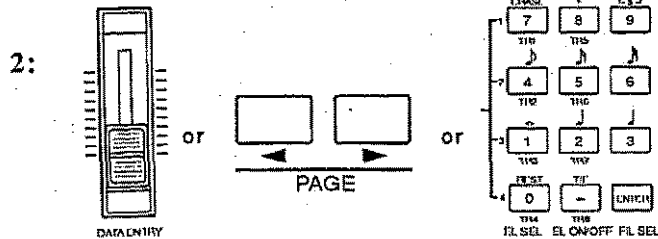

• To edit value of selected element or parameter.

Selecting an Element to Edit/Element ON-OFF Switching

Although the \leftarrow and \rightarrow cursor keys are used to select a particular element in many functions, some functions that can be individually programmed for each element contain several different parameters which must be selected using the \leftarrow and \rightarrow keys, so an alternative means of element selection has been provided.

If you press and hold the [SELECT] key the element selection and switching display will appear.

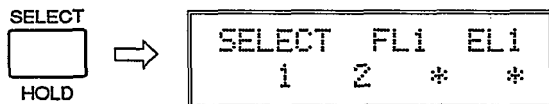

On the upper display line "FL1" indicates that Filter 1 is selected and "EL1" indicates that Element 1 is selected. The lower display line indicates that the 2-element mode has been selected (elements 1 and 2 are active). The asterisks (*) indicate elements that are not available (3 and 4 in this case).

While the [SELECT] key is held, any of the available elements can be selected by pressing the corresponding [EL SEL] key (note the green markings next to the numeric [7], [4], [1] and [0] keys).

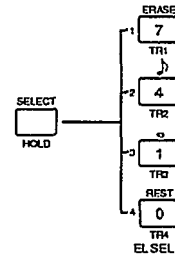

Also while the [SELECT] key is pressed, any of the available elements can also be turned ON or OFF (usually to hear how a single element in a multiple-element voice sounds) by pressing the corresponding [EL ON/OFF] key (the numeric [8], [5], [2] and [-] keys). An available element that has been turned OFF in this manner appears as a "-" on the display.

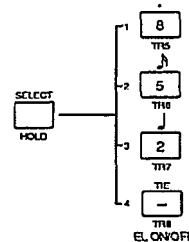

Releasing the [SELECT] key returns the display to the current function.

Edit/Compare Operation

Normally, when you play a voice that is being edited in the voice edit mode you hear the sound of the edited voice. This can be compared with the original (pre-edit) sound by pressing the [EDIT/COMPARE] key to activate the COMPARE mode. The [EDIT/COMPARE] key indicator will flash while the COMPARE mode is active. Press the [EDIT/COMPARE] key again to return to the VOICE EDIT mode.

NOTE: While the COMPARE mode is active it is not possible to select any other functions. The [EXIT] key can be used, however, to return to the voice play mode.

NOTE: When the compare function is used, the contents of the TG55 "recall buffer" are replaced with the current contents of the edit buffer (i.e. the current status of the voice being edited). This can affect the outcome of a VOICE RECALL operation — see "VOICE RECALL" on page 77.



The Element, AEG and Filter Copy Functions

The Element, AEG and Filter Copy functions make it possible to copy all parameter assignments, just the AEG parameter assignments, or just the filter parameter assignments from any other element to the element currently being edited. This is useful if, for example, you want to create an AEG curve that is the same as, or varies only slightly from, one that already exists.

1. Make sure the voice edit mode is engaged and that any function other than one of the EFFECT, AEG or FILTER functions is selected if you want to copy all element parameters, that one of the AEG functions is selected if you want to copy the AEG parameters, or that one of the FILTER functions is selected if you want to copy the filter parameters.
2. Select the element to which the new parameter data will be copied using the standard element selection procedure described above.
3. Press the [STORE/COPY] key. One of the following displays will appear, depending on the currently selected function.

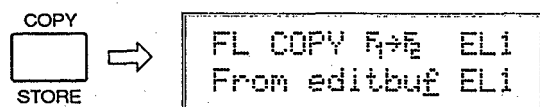
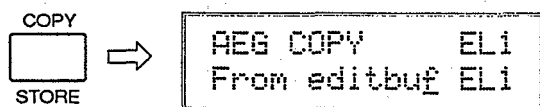
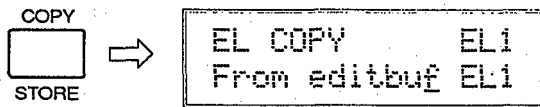

4. Next, select the voice from which the parameter data is to be copied by using the [DATA ENTRY] control, [-1/NO] and [+1/YES] keys, or numeric and [ENTER] keys. "editbuf" refers to the voice that is currently being edited, and other voices can be selected by using standard procedure — [INTERNAL], [CARD], or [PRESET] key to select voice bank; [DATA ENTRY] control, [-1/NO] and [+1/YES] keys, or numeric and [ENTER] keys to select the voice.

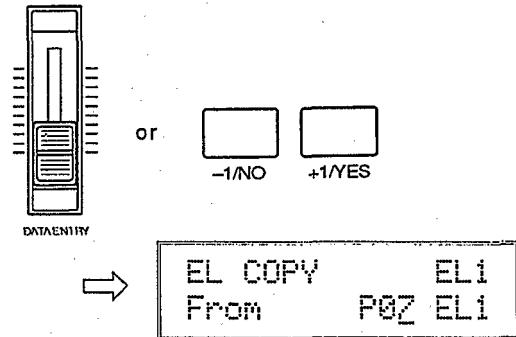

5. Move the underline cursor to the element parameter to the right by pressing the [⇨] key, then choose the particular element of the selected voice you want to copy the data from using the [DATA ENTRY] control or [+1/YES] and [-1/NO] keys.* If the element number appears in reverse, the voice does not use that element and no data is available.

* For Filter Copy, the "editbuf" setting allows copying parameters from filter 1 to filter 2, or vice versa, when copying within the same element (e.g. EL1 → EL1). In this case, the filter to be copied to must be selected prior to pressing [STORE/COPY] key by holding the [SELECT] key and pressing either the numeric [9] or [6] key. "F2 →F1" or "F1 →F2" will appear on the upper line of the display to show the selected copy direction.

6. When the elements to and from which the data is to be copied have been properly selected, press the [ENTER] key. "Sure?" will appear on the top line of the LCD.

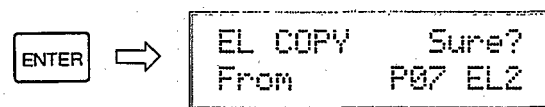

7. Press the [+1/YES] key to confirm and actually execute the copy operation, or [-1/NO] to cancel. "Executing!" will appear briefly on the display while the data is being copied, then "Completed!" will appear for a few seconds when the copy operation has been successfully completed.

- When the copy operation has finished, the SY55 will return automatically to the display that was showing immediately prior to activation of the element copy function.

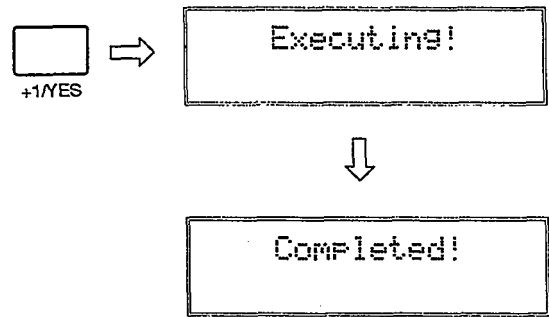

The Effect Copy Function

The Effect Copy function makes it possible to copy the effect parameter assignments from any other voice or multi-timbral setup to the voice currently being edited.

- Make sure the voice edit mode is engaged and that one of the EFFECT functions is selected.
- Press the [STORE/COPY] key. The following display will appear.

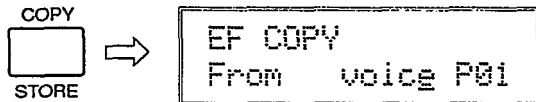

- Use the [←] and [→] cursor keys to move to the Multi/Voice parameter and select "Multi" if you want to copy the effect parameters from a multi-timbral setup, or "Voice" if you want to copy the effect parameters from a preset or internal voice.
- Next, move the cursor to the multi or voice number parameter by pressing the [→] key, and select the multi-timbral setup or voice from which the parameter data is to be copied by using the [DATA ENTRY] control, [-1/NO] and [+1/YES] keys, or numeric and [ENTER] keys. The [INTERNAL], [CARD], or [PRESET] key can be used to select the "P" (preset) or "I" voice bank if necessary.

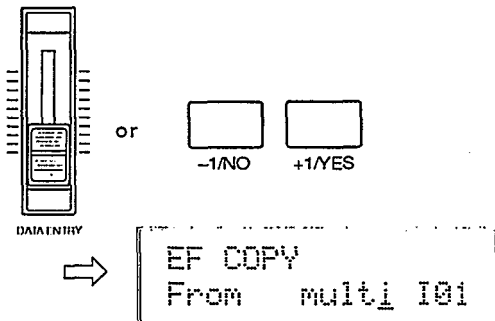

- Press the [ENTER] key. "Sure?" will appear on the top line of the LCD.

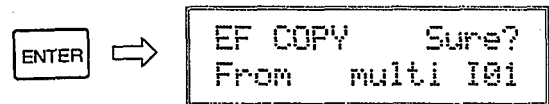

- Press the [+1/YES] key to confirm and actually execute the copy operation, or [-1/NO] to cancel. "Executing!" will appear briefly on the display while the data is being copied, then "Completed!" will appear for a few seconds when the copy operation has been successfully completed.

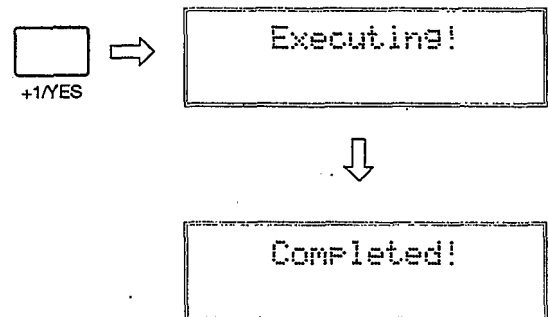

- When the copy operation has finished, the SY55 will return automatically to the display that was showing immediately prior to activation of the effect copy function.

JOBS & PARAMETERS

VOICE MODE

JOB 1

```
VOICE Mode
  = 1 Element
```

Summary: Determines whether the voice will be a 1-element (max. 16-note polyphony), 2-element (max. 8-note polyphony) or 4-element (max. 4-note polyphony) type.

Settings: 1 Element, 2 Element, 4 Element.

Procedure: The [DATA ENTRY] control or [+1/YES] and [-1/NO] keys are used to select the desired number of elements.

Details: The number of elements used in a voice basically determines the number of different waveforms that can be played simultaneously: one waveform in the 1-element mode, two waveforms in the 2-element mode, and four waveforms in the 4-element mode. Since each individual element has its own waveform, filters, envelope generator, etc., the waveforms in a multi-element voice can be combined in several

different ways. They can simply be played simultaneously, limited to specific regions of the keyboard to create a "split keyboard" voice, one waveform could be used only for the attack portion of the voice while another is used for the sustain, and so on.

When selecting the 2- or 4-element mode, always keep in mind the fact that these modes reduce the number of notes you can play at the same time:

Mode	Polyphony
1-element mode:	16 notes
2-element mode:	8 notes
4-element mode:	4 notes

The tutorial goes into further detail concerning the use of the multi-element modes.

Refer to: Tutorial, page 35...37, 42.

AWM WAVE SELECTION

JOB 2

```
<Piano > EL1
#P01 *** *** ***
```

Summary: Assigns a preset or card wave to each active voice element.

Settings:

P01 ... P58 (preset voices)
P59 ... P74 (preset drums)
C01 ... max. C99 (card voices)

Procedure: When the 1-element mode is selected (as in the example LCD display, above), only a single wave may be assigned. The unavailable elements are each represented by "***" on the display.

If the 2- or 4-element mode is selected, different waves may be assigned to each available element. The [◀] and [▶] cursor keys are used to move the cursor to the desired element (EL1, EL2, EL3 or EL4 will appear in the upper right-hand corner of the display), and the [DATA ENTRY] control, [-1/NO] and [+1/YES] keys, or numeric and [ENTER] keys are used to assign the desired wave to the selected element. The wave number (P01... P74, C01... C99) is shown at the current cursor location, and the full name of the assigned wave is shown in the upper left-hand corner of the display.

Details: Completely different waves can be assigned to each element, but it is also possible to assign the same wave to different elements. In this case

the waves can be filtered differently and/or have different envelopes to create an endless range of interesting effects.

Refer to: Tutorial, page 35, 42.

VOLUME

JOB 3

```
Volume 127  EL1
▶127 *** *** ***
```

Summary: Allows individual adjustment of element volume as well as overall (total) volume adjustment.

Settings: 0 ... 127

Procedure: The [◀] and [▶] cursor keys are used to select the element for which the volume is to be adjusted, or overall "Total" volume control (EL1, EL2, EL3, EL4 or Total will appear in the upper right-hand corner of the display). Unavailable elements are represented by "***" on the display. The [DATA ENTRY] control, [-1/NO]

and [+1/YES] keys, or numeric and [ENTER] keys are used to set the desired volume.

Details: A setting of "0" produces no sound while a setting of "127" produces maximum volume.

The ability to independently adjust the volume of each element makes it simple to set up the optimum balance or "mix" between elements. Overall volume adjustment can be used to match the the overall level of different voices.

Refer to: Tutorial, page 42.

NOTE SHIFT

JOB 4

```
Note Shift  EL1
▶+0 *** *** ***
```

Summary: Individually shifts the pitch of each active element up or down in semitone steps.

Settings: -64 ... +63.

Procedure: The [◀] and [▶] cursor keys are used to select the element to be note-shifted (EL1, EL2, EL3 or EL4 will appear in the upper right-hand corner of the display). Unavailable elements are represented by "***" on the display. The [DATA ENTRY] control, [-1/NO] and [+1/YES] keys, or numeric and [ENTER] keys are used to set the desired degree of note shift.

Details: A setting of "-12," for example, shifts the pitch of the selected element down by one octave; a setting of "+4" shifts the pitch up by a major third.

The Note Shift function can be used to transpose a voice to its most useful range, or to create harmony (intervals) between different elements in a multi-element voice.

Refer to: Utilitymode"TRANSPOSE,"page 132.

```

Detune      EL1
▶ +0 *** *** ***

```

Summary: Allows slight upward or downward pitch adjustment of each active element.

Settings: -7 ... +7

Procedure: The [◀] and [▶] cursor keys are used to select the element to be detuned (EL1, EL2, EL3 or EL4 will appear in the upper right-hand corner of the display). Unavailable elements are represented by "****" on the display. The [DATA ENTRY] control, [-1/NO] and [+1/YES] keys, or numeric and [ENTER] keys are used to set the desired degree of detuning.

Details: The maximum minus setting of "-7" produces a downward pitch shift of approximately a quarter of a semitone, and the maximum plus setting of "+7" produces an upward pitch shift of approximately the same amount. A setting of "0" produces no pitch change.

The Detune function allows different elements in a multi-element voice to be slightly detuned in relation to each other, thereby "thickening" the overall sound.

Refer to: "OSCILLATOR MODE/NOTE/TUNE," page 63.

```

Note Limit/L EL1
▶ C-2 *** *** ***

```

Summary: Individually sets the low note limit for each active element (the lowest note that each element will produce).

Settings: C-2 ... G8

Procedure: The [◀] and [▶] cursor keys are used to select the element for which the low note limit is to be set (EL1, EL2, EL3 or EL4 will appear in the upper right-hand corner of the display). Unavailable elements are represented by "****" on the display. The [DATA ENTRY] control or [+1/YES] and [-1/NO] keys are used to set the low note limit.

The low note limit can also be set by pressing the [ENTER] key — "KBD" will flash on the display — and then the key on the keyboard corresponding to the desired low note.

Details: The C-2 to G8 range of this function covers a full 10-1/2 octaves. "C3" corresponds to "middle C" on a keyboard.

This function, in conjunction with the High

Note Limit function described below, allows the sound from an element to be limited to a specific region of the keyboard (or scale of other types of MIDI controllers). If the Low Note Limit is set to C3 and the High Note Limit for the same element is set to C4, for example, the sound from that element will only be produced between C3 and C4 — the octave immediately above middle C. This makes it simple to produce split voices.

If the High Note Limit is set to a note that is lower than the Low Note Limit for the same element, the full range of notes (C-2...G8) will be produced.

Refer to: Tutorial, page 36. "HIGH NOTE LIMIT" on page 61.

```

Note Limit/L EL1
#KBD *** *** ***

```

HIGH NOTE LIMIT

JOB 7

```
Note Limit/H EL1
▶ G8 *** *** ***
```

Summary: Individually sets the high note limit for each active element (the highest note that each element will produce).

Settings: C-2 ... G8

Procedure: The [◀] and [▶] cursor keys are used to select the element for which the high note limit is to be set (EL1, EL2, EL3 or EL4 will appear in the upper right-hand corner of the display). Unavailable elements are represented by "****" on the display. The [DATA ENTRY] control or [+1/YES] and [-1/NO] keys are used to set the high note limit.

The high note limit can also be set by pressing the [ENTER] key — "KBD" will flash on the display — and then the key on the keyboard corresponding to the desired high note.

Details: See "LOW NOTE LIMIT," above.

Refer to: Tutorial, page 36. "LOW NOTE LIMIT" on page 60.

LOW VELOCITY LIMIT

JOB 8

```
Vel. Limit/L EL1
▶ 1 *** *** ***
```

Summary: Sets the lowest velocity value for a range of velocity values over which each active element will produce output.

Settings: 1 ... 127

Procedure: The [◀] and [▶] cursor keys are used to select the element for which the low velocity limit is to be set (EL1, EL2, EL3 or EL4 will appear in the upper right-hand corner of the display). Unavailable elements are represented by "****" on the display. The [DATA ENTRY] control, [-1/NO] and [+1/YES] keys, or numeric and [ENTER] keys are used to set the low velocity limit.

The low velocity limit can also be set by pressing the [ENTER] key — "KBD" will flash on the display — and then a key on the keyboard at approximately the desired velocity.

Details: Every MIDI "NOTE ON MESSAGE" (the MIDI message that is transmitted every time a note is played on a keyboard or other MIDI con-

troller) contains a "velocity" value that tells the tone generator how hard the note has been played. The range, of MIDI velocity values is from 1 to 127— thus the 1 ... 127 range of this function.

The Low Velocity Limit function, in conjunction with the High Velocity Limit function described below, makes it possible to specify a range of velocity values over which the selected element will produce sound. You could, for example, set Low Velocity Limit to "60" and High Velocity Limit to "127." This would cause that element to produce output only when a velocity value between 60 and 127 was received — i.e. when a fairly loud note is played. A second element could then be set to produce output only when velocity values below 60 are received, so that completely different sounds are produced on soft and loud notes.

Refer to: Tutorial, page 43. "HIGH VELOCITY LIMIT" on page 62.

HIGH VELOCITY LIMIT

JOB 9

```
Vel. Limit/H EL1  
#127 *** **
```

Summary: Sets the highest velocity value for a range of velocity values over which each active element will produce output.

Settings: 1 ... 127

Procedure: The [←] and [→] cursor keys are used to select the element for which the high velocity limit is to be set (EL1, EL2, EL3 or EL4 will appear in the upper right-hand corner of the display). Unavailable elements are represented by "****" on the display. The [DATA ENTRY] control, [-1/NO] and [+1/YES] keys, or numeric

and [ENTER] keys are used to set the high velocity limit.

The high velocity limit can also be set by pressing the [ENTER] key — "KBD" will flash on the display — and then a key on the keyboard at approximately the desired velocity.

Details: See "LOW VELOCITY LIMIT," above.

Refer to: Tutorial, page 43. "LOW VELOCITY LIMIT" on page 61.

PANNING

JOB 10

```
Pan L.....R EL1  
+0 *** **
```

Summary: Determines the position in the stereo sound field in which the sound from each active element will be heard (left to right).

Settings: -31...+31

Procedure: The [←] and [→] cursor keys are used to select the element for which the pan position is to be set (EL1, EL2, EL3 or EL4 will appear in the upper right-hand corner of the display). Unavailable elements are represented by "****" on the display. The [DATA ENTRY] control, [-1/NO] and [+1/YES] keys, or numeric and [ENTER] keys are used to set the pan position.

The upper line of the display also shows a graphic representation of the stereo sound field with "L" representing "left" and "R" representing "right." As you change the pan value the vertical bar will appear at the corresponding position on the graphic display.

Details: Minus values represent panning to the left, and positive values represent panning to the right. "0" positions the sound of the selected element in the center of the stereo sound field.

For a single-element voice the Pan position should generally be set to center ("0") unless you have some specific reason why you want the sound to appear only at the L/MONO or R output jack. In multi-element voices interesting stereo effects can be produced by placing the output from different elements at different locations in the stereo sound field.

Refer to: "THE CONTROLS AND CONNECTORS," page 7.

EFFECT BALANCE

JOB12

```

EF Balance  EL1
▶ 50 *** *** ***

```

Summary: Determines the balance between the direct and effect sound for each active element.

Settings: 0 ... 100

Procedure: The [◀] and [▶] cursor keys are used to select the element for which the effect balance is to be set (EL1, EL2, EL3 or EL4 will appear in the upper right-hand corner of the display). Unavailable elements are represented by "****" on the display. The [DATA ENTRY] control, [-1/NO] and [+1/YES] keys, or numeric and [ENTER] keys are used to set the effect balance.

Details: A setting of "0" produces only the direct sound of the selected element, while a setting of "100" produces only the effect sound. A setting of "50" delivers both the direct and effect sound in approximately equal proportions.

The effect (reverb, delay, etc.) applied to the voice is selected and edited using the EFFECT functions described on page 86.

Refer to: Tutorial, page 43. "EFFECT: TYPE/OUTPUT LEVEL" on page 85. "EFFECT: EFFECT PARAMETERS" on page 86. Utility mode "EFFECT" on page 133.

OSCILLATOR MODE/NOTE/TUNE

JOB12

● Frequency Mode

```

OSC Frq.Mode EL1
norm          +0

```

Summary: Determines whether the AWM wave for the selected element is reproduced in the normal (variable pitch) or fixed-pitch mode.

Settings: norm, fix

Procedure: If the Frequency Mode ("Frq.Mode" on upper LCD line) parameter is not already selected, use the [◀] and [▶] cursor keys to select it. Use the [DATA ENTRY] control or [+1/YES] and [-1/NO] keys to select the "fix" or "norm" setting.

Details: Normally you want the pitch of the AWM wave (or waves) used in a voice to be controllable from a keyboard or other type of controller, so this parameter will be set to "norm" for most applications.

In some cases — sound effects in particular — you might want the same pitch to be produced no matter what note you play on the keyboard or other controller. In this case, the "fix" mode is appropriate. The Frequency Note parameter described below can be used to set the note produced when the "fix" mode is selected.

● Frequency Note

```

OSC Frq.Note EL1
fix  A3  +0
  
```

Summary: Sets the frequency (note) of the AWM wave for the selected element when the "fix" mode (above) is selected.

Settings: C-2 ... G8

Procedure: The "Frq.Note" parameter only appears when the "Frq.Mode" parameter described above has been set to "fix."

Use the [◀] and [▶] cursor keys to select the Frequency Note ("Frq.Note") parameter. Use the [DATA ENTRY] control or [+1/YES] and [-1/NO] keys to select the desired note.

The frequency note can also be set by pressing the [ENTER] key — "KBD" will flash on the display — and then the key on your keyboard corresponding to the desired note.

Details: The C-2 to G8 range of this parameter covers a full 10-1/2 octaves. "C3" corresponds to "middle C" on a keyboard.

Refer to: "NOTE SHIFT," page 59.

● Frequency Tune

```

OSC Frq.Tune EL1
fix  A3  +0
  
```

Summary: Allows tuning of the AWM wave assigned to the selected element.

Settings: -64 ... +63

Procedure: Use the [◀] and [▶] cursor keys to select the Frequency Tune ("Frq.Tune") parameter. Use the [DATA ENTRY] control, [-1/NO] and [+1/YES] keys, or numeric and [ENTER] keys to set the tuning as required.

Details: Each tuning increment corresponds to a 75/64-cent change in pitch. The entire tuning range is therefore $75/64 \times 127$ (i.e. 64 + 63 increments) — almost 150 cents. Since 100 cents equals one semitone, the tuning range is approximately one and a half semitones. A setting of "0" produces normal pitch (A3 = 440 Hertz).

Please note that this parameter is used to individually tune different elements within a voice. Overall tuning control is provided by the MASTER tune function in the UTILITY mode.

Refer to: "MASTER TUNE" on page 132. "DETUNE" on page 60.

AMPLITUDE ENVELOPE GENERATOR (AEG)

MODE/LEVEL/RATE

JOB 13

```

AEG Mode EL1
nrm 53 5 584
  
```

Summary: All the parameters within this function determine the "shape" of the amplitude envelope of the selected element.

Settings:

Mode parameter: nrm, hld

R1/HT, R2, L2, R3, L3, R4 and RR parameters:
0 ... 63

Procedure: If the Mode ("Mode" on upper LCD line) parameter is not already selected, use the [◀] and [▶] cursor keys to select it, then use the [DATA ENTRY] control, [-1/NO] and [+1/YES] keys to select the "nrm" (normal) or "hld" (hold) setting. Once the desired mode has been selected, use the [◀] and [▶] cursor keys to select the various rate and level parameters in turn (R1/HT, R2, L2, R3, L3, R4 and RR), using the [DATA ENTRY] control or [+1/YES] and [-1/NO] keys, or numeric and [ENTER] keys to set the value of each. "R1" (Rate 1) will appear

when the "nrm" mode has been selected, but "HT (Hold Time)" will appear instead when the "hld" mode is selected.

The arrow symbols (← and →) that appear at either end of the display mean that more parameters can be accessed by moving the cursor in the indicated direction using the [←] and [→] keys.

Details:

The "nrm" and "hld" mode settings affect the initial attack of the sound, determining how the amplitude envelope begins. In the "nrm" mode, the envelope begins from zero level, reaching the maximum AWM level at a rate determined by the R1 (Rate 1) parameter. In this mode there will always be a slight delay between the initiation of a note and maximum level. The following two diagrams show the kind of envelopes that can be produced in the "nrm" mode.

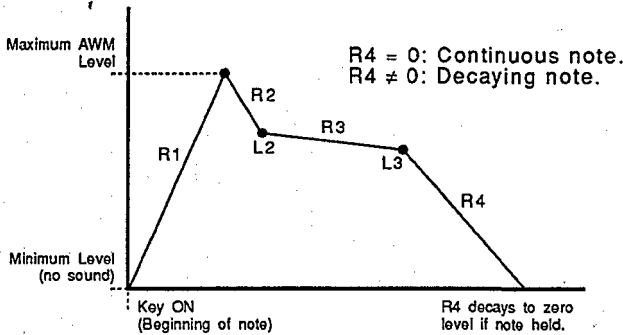

The envelop begins at zero level, reaches maximum level at the rate determined by the R1 parameter, moves to L2 (Level 2) at R2 (Rate 2), moves on to L3 (Level 3) at R3 (Rate 3), and finally decays to zero level at R4 (Rate 4) if the note is held the entire time.

If the note is released before the end of the envelope described above, then the sound decays to zero level from the point at which the note is released at the rate determined by the RR (Release Rate) parameter.

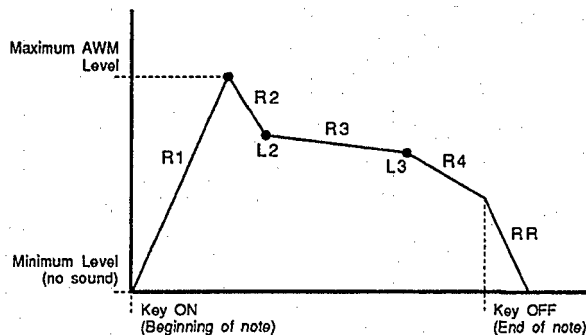

If the "hld" mode is selected, the envelope begins immediately from maximum AWM level, allowing the fast attack transients of waveforms to pass unaffected. In this case the R1 parameter is replaced by the HT (Hold Time) parameter. The HT parameter determines the length of time between the beginning of the envelope and the point at which the envelope begins to move towards L2 (Level 2) at R2 (Rate 2), as shown below.

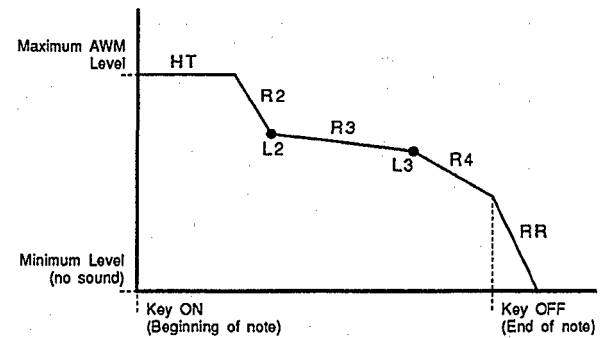

For the level parameters, a setting of "0" corresponds to the lowest possible level (no sound) while a setting of "63" produces the highest output level. A "0" rate parameter setting produces the slowest rate between levels, while the maximum setting of "63" produces the fastest (almost instantaneous) change.

Refer to: Tutorial, page 36, 44.

AMPLITUDE ENVELOPE GENERATOR (AEG) RATE SCALING JOB 14

```
AEG R.Scale  EL1
              =+Z
```

Summary: Allows the overall amplitude envelope generator decay rate for the selected element to be varied across the entire pitch range.

Settings: -7 ... +7

Procedure: Use the [DATA ENTRY] control, [-1/NO] and [+1/YES] keys, or numeric and [ENTER] keys to set the desired degree of rate scaling.

Details: Plus ("+") settings produce a longer overall envelope time for the low notes and a shorter en-

velope time for the high notes. This is useful for simulating instruments such as piano, in which the low notes take much longer to decay than the high notes. The maximum "+7" setting produces the greatest envelope length variation across the pitch range. Minus ("-") settings produce the opposite effect — short low notes and long high notes. A setting of "+0" results in no envelope length variation.

Refer to: "AMPLITUDE ENVELOPE GENERATOR (AEG) MODE/LEVEL/RATE," page 64.

AMPLITUDE ENVELOPE GENERATOR (AEG) LEVEL SCALE BREAKPOINT JOB 15

```
AEG LS BP1  EL1
  C1  G2  E4  C6
```

Summary: Allows four separate amplitude envelope generator level-scaling breakpoints to be set at any notes between C-2 and G8 for the selected element.

Settings: C-2 ... G8

Procedure: Use the [←] and [→] cursor keys to select the desired breakpoint (BP1, BP2, BP3 and BP4, from left to right), then use the [DATA ENTRY] control or [+1/YES] and [-1/NO] keys to set the breakpoint note.

The breakpoint can also be set by pressing the [ENTER] key — "KBD" will flash on the display — and then the key on the keyboard corresponding to the desired breakpoint.

Details: Level scale offset values are applied to each of the breakpoints using the LEVEL SCALE OFFSET function described below. Natural level variations can thereby be produced across the range of the controlling keyboard. No breakpoint can be set to a key lower than the breakpoint to its left.

Refer to: "AMPLITUDE ENVELOPE GENERATOR (AEG) LEVEL SCALE OFFSET" below.

AMPLITUDE ENVELOPE GENERATOR (AEG) LEVEL SCALE OFFSET JOB 16

```
AEG LS OFS1  EL1
  +0  +0  +0  +0
```

Summary: Sets the amount of level offset for each of the four level-scaling breakpoints set in the "AMPLITUDE ENVELOPE GENERATOR

(AEG) LEVEL SCALE BREAKPOINT" function described above.

Settings: -127...+127

Procedure: Use the [←] and [→] cursor keys to select the desired offset parameter (OFS1, OFS2, OFS3 and OFS4, from left to right), then use the

[DATA ENTRY] control, [-1/NO] and [+1/YES] keys/or numeric and [ENTER] keys to set the level-scaling offset for the corresponding breakpoint.

Refer to: "AMPLITUDE ENVELOPE GENERATOR (AEG) LEVEL SCALE BREAKPOINT" on page 66.

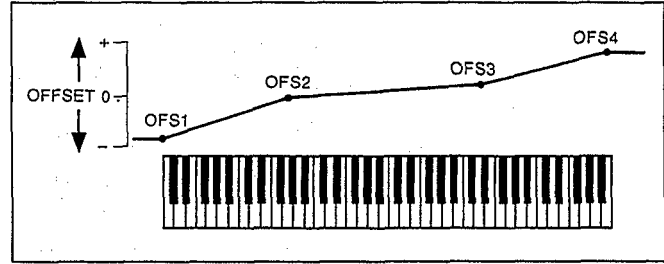

Details: Negative values reduce the level, and positive values increase the level at the corresponding breakpoint. No matter what value is chosen, the EG level will never exceed its maximum of 63.

When different offsets are set for adjacent breakpoints, the level varies accordingly and smoothly between the breakpoints.

SENSITIVITY (VELOCITY, AMPLITUDE & PITCH MODULATION), JOB 17

● **Velocity Sensitivity**

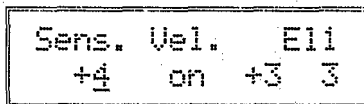

Summary: Determines how the output level of the selected element changes in response to velocity changes (e.g. keyboard dynamics).

Settings: -7...+7

Procedure: If the Velocity Sensitivity ("Vel." on upper LCD line) parameter is not already selected, use the [◀] and [▶] cursor keys to select it. Use the [DATA ENTRY] control, [-1/NO] and

[+1/YES] keys, or numeric and [ENTER] keys to select the required degree of velocity sensitivity.

Details: Plus "+" settings produce higher output level in response to higher velocity values — i.e. the harder a key is played, the louder the sound. The maximum setting of "+7" produces the maximum level variation in response to velocity changes. Minus "-" settings produce the opposite effect: lower level in response to higher velocity. A setting of "+0" results in no level variation. Make sure that the volume is turned down when making "-" settings, or you may not be able to hear the full effect.

● **Velocity Rate Sensitivity ON/OFF**

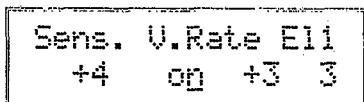

Summary: Determines whether overall envelope length of the amplitude envelope generator for the selected element will or will not be controlled by velocity information.

Settings: on, off

Procedure: Use the [◀] and [▶] cursor keys to select the Velocity Rate Sensitivity parameter

("V.Rate"). Use the [DATA ENTRY] control or [+1/YES] and [-1/NO] keys to select "on" or "off."

Details: When this parameter is turned "on," higher velocity values produce a faster attack rate. When "off" no envelope rate variation is produced.

Refer to: "AMPLITUDE ENVELOPE GENERATOR (AEG) MODE/LEVEL/RATE," page 64.

● Amplitude Modulation Sensitivity

Sens. AMS	E11
+4 on +3	3

Summary: Determines the sensitivity of the selected element to amplitude modulation (tremolo effect) applied via the low-frequency oscillator (LFO) and appropriate controllers.

Settings: -7 ... +7

Procedure: Use the [◀] and [▶] cursor keys to select the Amplitude Modulation Sensitivity parameter ("AMS"). Use the [DATA ENTRY] control, [-1/NO] and [+1/YES] keys, or numeric and [ENTER] keys to set the required degree of amplitude modulation sensitivity.

Details: A setting of "0" allows no amplitude modulation by any means, while a setting of "+7" results in maximum sensitivity to amplitude modulation. Minus settings produce reverse EG bias — i.e. a higher modulation value produces lower level.

When setting up the low-frequency oscillator or a controller to apply amplitude modulation, this parameter must be set to a value other than "0" for amplitude modulation to take place.

Refer to: "LOW FREQUENCY OSCILLATOR (LFO) WAVEFORM/SPEED/DELAY/PHASE" on page 69. "LOW FREQUENCY OSCILLATOR MODULATION DEPTH, AMPLITUDE/PITCH/CUTOFF" on page 70. "CONTROLLER" functions from page 81 to page 84.

● Pitch Modulation Sensitivity

Sens. PMS	E11
+4 on +3	3

Summary: Determines the sensitivity of the selected element to pitch modulation (vibrato effects) applied via appropriate controllers.

Settings: 0 ... 7

Procedure: Use the [◀] and [▶] cursor keys to select the Pitch Modulation Sensitivity parameter ("PMS"). Use the [DATA ENTRY] control, [-1/NO] and [+1/YES] keys, or numeric and [ENTER] keys to set the required degree of pitch modulation sensitivity.

Details: A setting of "0" allows no pitch modulation by any means, while a setting of 7 results in maximum sensitivity to amplitude modulation.

When setting up the low-frequency oscillator or a controller to apply pitch modulation, this parameter must be set to a value other than "0" for pitch modulation to take place.

Refer to: "LOW FREQUENCY OSCILLATOR (LFO) WAVEFORM/SPEED/DELAY/PHASE" on page 69. "LOW FREQUENCY OSCILLATOR MODULATION DEPTH, AMPLITUDE/PITCH/CUTOFF" on page 70. "CONTROLLER" functions from page 81 to page 84.

LOW FREQUENCY OSCILLATOR (LFO) WAVEFORM/SPEED/DELAY/PHASE

JOB 18

● Wave

```
LFO Wave  EL1
sin 37 20 0
```

Summary: Determines the waveform of the LFO for the selected element.

Settings: tri, dwn, up, squ, sin, S/H

Procedure: If the Wave parameter is not already selected, use the [\leftarrow] and [\rightarrow] cursor keys to select it. Use the [DATA ENTRY] control or [+1/YES] and [-1/NO] keys to select the desired LFO waveform.

Details:

"tri" = Triangle.
 "dwn" = Downward sawtooth.
 "up" = Upward sawtooth.
 "squ" = Square.
 "sin" = Sine.
 "S/H" = Sample and hold.

Refer to: "SENSITIVITY (VELOCITY, AMPLITUDE & PITCH MODULATION," page 67.

● Speed

```
LFO Speed  EL1
sin 32 20 0
```

Summary: Sets the speed of the LFO for the selected element.

Settings: 0 ... 99

Procedure: Use the [\leftarrow] and [\rightarrow] cursor keys to select the Speed parameter. Use the [DATA EN-

TRY] control, [-1/NO] and [+1/YES] keys, or numeric and [ENTER] keys to set the desired LFO speed.

Details: "0" produces the slowest LFO speed, and "99" produces the fastest LFO speed.

Refer to: "SENSITIVITY (VELOCITY, AMPLITUDE & PITCH MODULATION," page 67.

● Delay

```
LFO Delay  EL1
sin 37 20 0
```

Summary: Sets the delay time between the beginning of a note and the beginning of LFO operation for the selected element.

Settings: 0 ... 99

Procedure: Use the [\leftarrow] and [\rightarrow] cursor keys to select the Delay parameter. Use the [DATA EN-

TRY] control, [-1/NO] and [+1/YES] keys, or numeric and [ENTER] keys to set the desired LFO delay.

Details: The minimum setting of "0" results in no delay, while the maximum setting of "99" produces the longest possible delay before the LFO begins operation.

Refer to: "SENSITIVITY (VELOCITY, AMPLITUDE & PITCH MODULATION," page 67.

● Phase

```
LFO Phase  EL1  
sin 37 20 0
```

Summary: Determines at which point in the LFO waveform the LFO will begin operation for the selected element.

Settings: 0 ... 99

Procedure: Use the [◀] and [▶] cursor keys to select the Phase parameter. Use the [DATA EN-

TRY] control, [-1/NO] and [+1/YES] keys, or numeric and [ENTER] keys to set the desired LFO phase.

Details: If the LFO is used for pitch modulation, for example, a phase setting of "0" would cause the vibrato effect to begin with an upward pitch sweep, while a setting of "55" would cause the vibrato to begin with a downward pitch sweep. The change can be subtle, and experimentation is the best way to find the best setting.

Refer to: "SENSITIVITY (VELOCITY, AMPLITUDE & PITCH MODULATION," page 67.

LOW FREQUENCY OSCILLATOR MODULATION DEPTH, AMPLITUDE/PITCH/CUTOFF

JOB 19

● Amplitude Modulation Depth

```
LFO AMOD      EL1  
0 0 0
```

Summary: Determines the amount of amplitude modulation applied to the selected element.

Settings: 0 ... 127

Procedure: If the Amplitude Modulation ("AMOD") parameter is not already selected, use the [◀] and [▶] cursor keys to select it. Use the [DATA ENTRY] control, [-1/NO] and [+1/YES] keys, or numeric and [ENTER] keys to set the desired degree of amplitude modulation.

Details: A "0" setting produces no modulation while a setting of "127" produces maximum modulation. Amplitude modulation produces a periodic variation in the volume of the sound, thus creating a tremolo effect.

Please note that the amplitude modulation sensitivity parameter (see page 68) must also be set to an appropriate value before amplitude modulation can be applied.

Refer to: "Amplitude Modulation Sensitivity" on page 68.

● Pitch Modulation Depth

```
LFO PMOD      EL1  
0 0 0
```

Summary: Determines the amount of pitch modulation applied to the selected element.

Settings: 0 ... 127

Procedure: Use the [◀] and [▶] cursor keys to select the Pitch Modulation ("PMOD") parameter. Use the [DATA ENTRY] control or [+1/YES] and [-1/NO] keys, or numeric and [ENTER] keys to set the desired degree of pitch modulation.

Details: A "0" setting produces no modulation while a setting of "127" produces maximum modulation. Pitch modulation produces a periodic pitch variation, thereby creating a vibrato effect.

Please note that the pitch modulation sensitivity parameter (see page 68) must also be set to an appropriate value before pitch modulation can be applied.

Refer to: "Pitch Modulation Sensitivity" on page 68.

● Filter Cutoff Modulation Depth

```
LFO CutoffMOD EL1
  0  0  0
```

Summary: Determines the amount of modulation applied to the cutoff frequency of the filter of the selected element.

Settings: 0 ... 127

Procedure: Use the [◀] and [▶] cursor keys to select the Filter Cutoff Modulation ("Cut-ofMOD") parameter. Use the [DATA ENTRY] control, [-1/NO] and [+1/YES] keys, or numeric and [ENTER] keys to set the desired degree of cutoff modulation.

Details: A "0" setting produces no modulation while a setting of "127" produces maximum modulation. Filter cutoff modulation produces wah-wah type effects.

Please note that the filter cutoff modulation sensitivity parameter (see page 78) must also be set to an appropriate value before cutoff frequency modulation can be applied.

Refer to: Tutorial, page 37. "FILTER: RESONANCE/VELOCITY SENSITIVITY/MODULATION SENSITIVITY" on page 77.

PITCH ENVELOPE GENERATOR (PEG) LEVEL/RATE

JOB 20

```
PEG L0          EL1
  +0  0  +0+
```

Summary: All parameters within this function determine the "shape" of the pitch envelope generator for the selected element.

Settings:

L0, L1, L2, L3, and RL parameters: -64 ... +63
R1, R2, R3 and RR parameters: 0 ... 63

Procedure: Use the [◀] and [▶] cursor keys to select the various rate and level parameters in turn (L0, R1, L1, R2, L2, R3, L3, RR and RL), using the [DATA ENTRY] control, [-1/NO] and [+1/YES] keys, or numeric and [ENTER] keys to set the value of each.

The arrow symbols (← and →) that appear at either end of the display mean that more parameters can be accessed by moving the cursor in the indicated direction using the [◀] and [▶] keys.

Details: Unlike the amplitude envelope generator, the "Level" parameters of which actually correspond to volume levels, the pitch envelope generator level parameters correspond to pitch. Plus "+" values produce higher pitch while minus "-" values produce lower pitch. "0" level values produce normal pitch.

The "Rate" parameters work in the same way as the amplitude envelope generator rate parameters: a setting of "0" produces the slowest rate between levels, while the maximum setting of "63" produces the fastest (almost instantaneous) change.

The pitch envelope begins at L0 (Level 0), moves to L1 (Level 1) at a rate determined by the setting of R1, then to L2 (Level 2) at R2 (Rate 2), and then to L3 (Level 3) at R3 (Rate 3). The pitch stays at L3 until the key is released, and then moves to RL (Release Level) at the rate determined by RR (Release Rate).

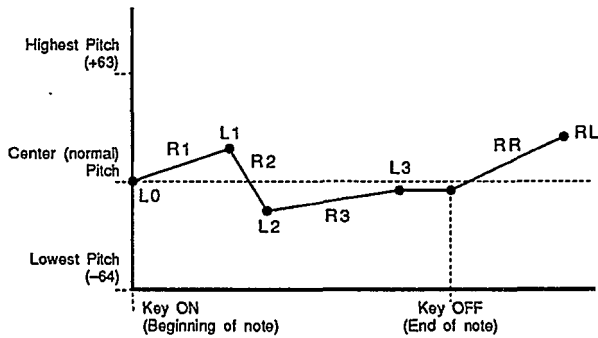

PITCH ENVELOPE GENERATOR SENSITIVITY, RANGE/RATE SCALING/VELOCITY SWITCH

JOB 21

● PEG Range

```

PEG Range      EL1
 2oct +3      on
  
```

Summary: Sets the maximum range of pitch envelope generator pitch variation.

Settings: 2oct, 1oct, 1/2oct

Procedure: If the Range parameter is not already selected, use the [◀] and [▶] cursor keys to select it. Use the [DATA ENTRY] control or [+1/YES] and [-1/NO] keys to select the desired range.

Details: This parameter determines the total maximum range of the pitch envelope generator, so a setting of "2oct" means that the maximum range is ± 1 octave. That is, if a level parameter is set to +63, for example, the pitch at that point will be one octave above normal pitch.

Refer to: "PITCH ENVELOPE GENERATOR (PEG) LEVEL/RATE," page 71.

● PEG Rate Scaling

```

PEG R.Scale    EL1
 2oct +3      on
  
```

Summary: Allows the overall pitch envelope generator rate for the selected element to be varied across the entire pitch range.

Settings: -7 ... +7

Procedure: Use the [◀] and [▶] cursor keys to select the Rate Scaling ("R.Scale") parameter. Use the [DATA ENTRY] control, [-1/NO] and [+1/YES] keys, or numeric and [ENTER] keys to set the desired degree of rate scaling.

Details: Plus "+" settings produce a longer overall envelope time for the low notes and a shorter envelope time for the high notes. The maximum "+7" setting produces the greatest envelope length variation across the pitch range. Minus "-" settings produce the opposite effect — a shorter low-note envelope and longer high-note envelope. A setting of "+0" results in no envelope length variation.

Refer to: "PITCH ENVELOPE GENERATOR (PEG) LEVEL/RATE," page 71.

● PEG Velocity Switch

```
PEG Vel.SW  EL1
Zoct: +3  00
```

Summary: Determines whether overall envelope length of the pitch envelope generator for the selected element will or will not be controlled by velocity information.

Settings: on, off

Procedure: Use the [◀] and [▶] cursor keys to select the Velocity Switch ("Vel.SW") parameter. Use the [DATA ENTRY] control or [+1/YES] and [-1/NO] keys to turn the velocity switch "on" or "off."

Details: When this parameter is turned "on," higher velocity values produce a longer pitch envelope — i.e. the harder a key is played the longer the pitch variation. When "off" no envelope rate variation is produced.

Refer to: "PITCH ENVELOPE GENERATOR (PEG) LEVEL/RATE," page 71.

FILTER: TYPE/CUTOFF/MODE JOB 22

● Type

```
FL1Type  EL1
LPE  92  LFO
```

Summary: Determines the response of the selected filter.

Settings:

Filter 1 (FL1): THU, LPF, HPF
Filter 2 (FL2): THU, LPF

Procedure: If the Type parameter is not already selected, use the [◀] and [▶] cursor keys to select it. Use the [DATA ENTRY] control or [+1/YES] and [-1/NO] keys to select the desired filter response.

Filter 1 or Filter 2 can be selected by holding the [SELECT] key and pressing the numeric [9] or [6] key, respectively.

Details: The "THU" (THROUGH) setting turns the filter OFF.

The "LPF" (Low Pass Filter) setting produces a filter response that allows only frequencies below the cutoff frequency (See "Cutoff" below) to pass.

LPF Filter Response

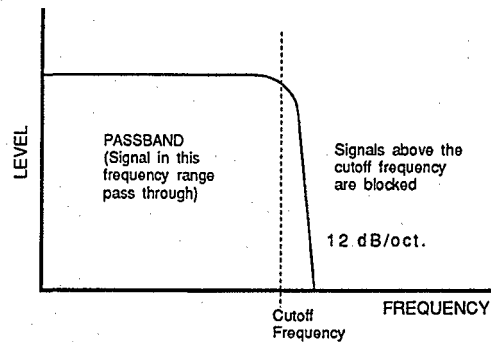

The "HPF" (High Pass Filter — available only on filter 1) setting produces a filter response that allows only frequencies above the cutoff frequency (See "Cutoff" below) to pass.

HPF Filter Response

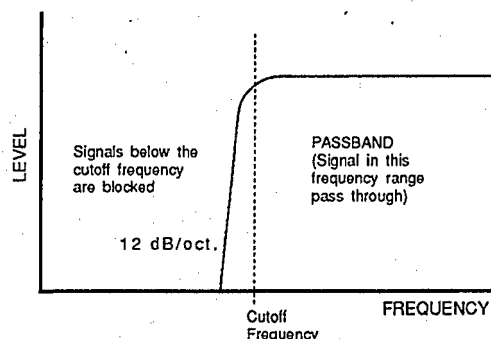

By combine the HPF setting of filter 1 with the LPF setting of filter 2, it is possible to create a BPF (Band Pass Filter) response that allows only frequencies that fall between the cutoff of the HPF and LPF to pass. In this case the cutoff of the LPF must be set at a higher frequency than that of the HPF. It is also possible to set both filters to "LPF" and the same cutoff frequency, resulting in a steep 24-dB per octave filter slope.

Refer to: Tutorial, page 37, 45. "FILTER: CUTOFF ENVELOPE GENERATOR," page 75.

Bandpass Filter (HPF + LPF) Response

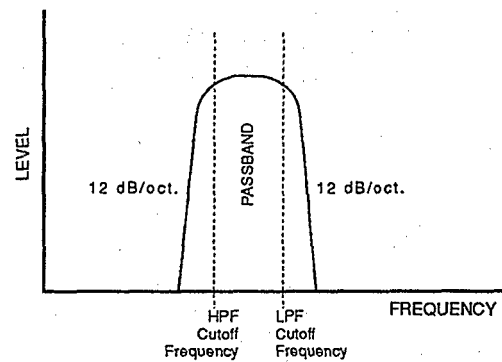

● Cutoff

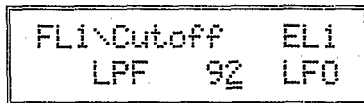

Summary: Sets the cutoff frequency of the selected filter.

Settings:

- 0...127 (LPF)
- 0...114 (HPF)

Procedure: Use the [\leftarrow] and [\rightarrow] cursor keys to select the Cutoff parameter. Use the [DATA ENTRY] control, [-1/NO] and [+1/YES] keys, or numeric and [ENTER] keys to select the desired cutoff frequency.

Filter 1 or Filter 2 can be selected by holding the [SELECT] key and pressing the numeric [9] or [6] key, respectively.

Details: Lower cutoff values produce a lower cutoff frequency and higher values produce a higher cutoff frequency.

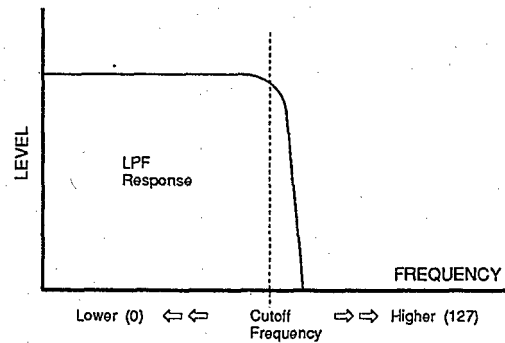

With an LPF response, a lower cutoff frequency reduces the range of high frequencies passed, making the sound "darker" or "rounder."

With a HPF response, a higher cutoff frequency reduces the range of low frequencies passed, making the sound "thinner" or "sharper."

Refer to: Tutorial, page 37, 45. "FILTER: CUTOFF ENVELOPE GENERATOR," page 75.

● Mode

```

FL1\Mode    EL1
      LPF  92  LFO
  
```

Summary: Determines whether the cutoff frequency of the selected filter will be controlled by the LFO or by the filter envelope generator (EG).

Settings: EG, LFO, EGVA

Procedure: Use the [◀] and [▶] cursor keys to select the Mode parameter. Use the [DATA ENTRY] control or [+1/YES] and [-1/NO] keys to select the "EG" or "LFO" setting.

Filter 1 or Filter 2 can be selected by holding the [SELECT] key and pressing the numeric [9] or [6] key, respectively.

Details: Varying the filter cutoff frequency can create "sweep" or "wah-wah" type effects. If the cutoff is controlled via the LFO a cyclic variation based on the "shape" of the selected LFO

waveform is produced. If EG control is selected, the filter envelope generator (a separate EG is provided for each filter — see "FILTER: CUTOFF ENVELOPE GENERATOR" below) can be set up to produce a wide range of time-based variations.

Please note that if "LFO" is selected, the filter cutoff envelope generator parameters have no effect on the sound and will not appear on the display: Cutoff EG levels and rates, rate scaling, and level scaling. The filter can only be controlled from controllers (modulation wheel, etc.) if the LFO mode is selected.

If the "EGVA" setting is selected, the R1 and L1 envelope parameters are controlled by note velocity (i.e. the harder a key is played the higher the R1 speed and L1 level). All EG parameters are controlled by note velocity when "EG" is selected.

Refer to: Tutorial, page 37, 45. "FILTER: CUTOFF ENVELOPE GENERATOR," below.

FILTER: CUTOFF ENVELOPE GENERATOR

JOB 23

```

FL1\CEG L0  EL1
      +0 63 +20+
  
```

Summary: All parameters within this function determine the "shape" of the cutoff envelope generator for the selected filter. This function is only available if the "Mode" parameter (page 63) is set to "EG" or "EGVA."

Settings:

L0, L1, L2, L3, L4, RL1 and RL2 parameters:
-64 ... +63

R1, R2, R3, R4, RR1 and RR2 parameters:
0 ... 63

Procedure: Use the [◀] and [▶] cursor keys to select the various rate and level parameters in turn (L0, R1, L1, R2, L2, R3, L3, R4, L4, RR1, RL1, RR and RL2), using the [DATA ENTRY] control, [-1/NO] and [+1/YES] keys, or numeric and [ENTER] keys to set the value of each.

The arrow symbols (↔ and ⇆) that appear at either end of the display mean that more para-

eters can be accessed by moving the cursor in the indicated direction using the [◀] and [▶] keys.

The filter 1 or filter 2 envelope generator can be selected by holding the [SELECT] key and pressing the numeric [9] or [6] key, respectively.

Details: The cutoff envelope generator level parameters correspond to cutoff frequency. Plus "+" values produce higher cutoff frequencies while minus "-" values produce lower cutoff frequencies. "0" level values produce the normal cutoff frequency as determined by the cutoff parameter (See "Cutoff" on page 74).

The "Rate" parameters work in the same way as the amplitude, and pitch envelope generator rate parameters: a setting of "0" produces the slowest rate between levels, while the maximum setting of "63" produces the fastest (almost instantaneous) change.

The pitch envelope begins at L0 (Level 0), moves to L1 (Level 1) at a rate determined by the setting of R1, then to L2 (Level 2) at R2

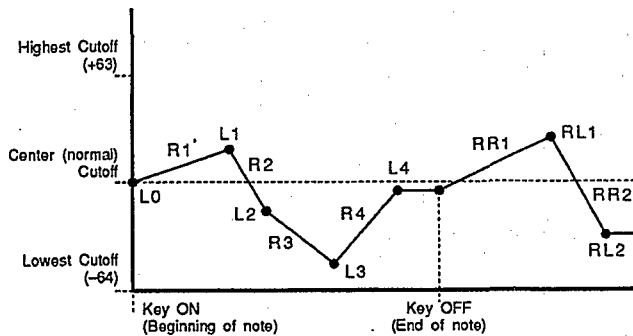

(Rate 2), then to L3 (Level 3) at R3 (Rate 3), and then to L4 (Level 4) at R4 (Rate 4). The cutoff stays at L4 until the key is released, and then moves to RL1 (Release Level 1) at the rate determined by RR1 (Release Rate 1), and finally to RL2 (Release Level 2) at RR2 (Release Rate 2).

Refer to: Tutorial, page 37, 45. "FILTER: RATE SCALING," below. "FILTER: LEVEL SCALING BREAKPOINT," below. "FILTER: LEVEL SCALING OFFSET," page 77.

FILTER: RATE SCALING

JOB 24

```
FL1\R.Scale  EL1
              =+Z
```

Summary: Allows the overall cutoff envelope generator rate for the selected filter to be varied across the entire pitch range (i.e. keyboard range). This function is only available if the "Mode" parameter (page 75) is set to "EG" or "EGVA."

Settings: -7 ... +7

Procedure: Use the [DATA ENTRY] control, [-1/NO] and [+1/YES] keys, or numeric and [ENTER] keys to set the desired degree of rate scaling.

The filter 1 or filter 2 envelope generator

can be selected by holding the [SELECT] key and pressing the numeric [9] or [6] key, respectively.

Details: Plus ("+") settings produce a longer overall envelope time for the low notes and a shorter envelope time for the high notes. The maximum "+7" setting produces the greatest envelope length variation across the pitch range. Minus ("-") settings produce the opposite effect — a shorter low-note envelope and longer high-note envelope. A setting of "+0" results in no envelope length variation.

Refer to: "FILTER: CUTOFF ENVELOPE GENERATOR," page 75.

FILTER: LEVEL SCALING BREAKPOINT

JOB 25

```
FL1\LS BP1  EL1
C1 G2 E4 C6
```

Summary: Allows four separate cutoff envelope generator level-scaling breakpoints to be set at any notes between C-2 and G8 for the selected filter.

Settings: C-2 ... G8

Procedure: Use the [◀] and [▶] cursor keys to select the desired breakpoint (BP1, BP2, BP3 and BP4, from left to right), then use the [DATA ENTRY] control or [+1/YES] and [-1/NO] keys to set the breakpoint note.

The filter 1 or filter 2 envelope generator can be selected by holding the [SELECT] key

and pressing the numeric [9] or [6] key, respectively.

The breakpoint can also be set by pressing the [ENTER] key — "KBD" will flash on the display — and then the key on the keyboard corresponding to the desired breakpoint.

Details: Level scale offset values are applied to each of the breakpoints using the LEVEL SCALE OFFSET function described below. Natural filter level variations can thereby be produced across the range of the controlling keyboard.

Refer to: "FILTER: LEVEL SCALING OFFSET" on page 77. "FILTER: CUTOFF ENVELOPE GENERATOR," page 75.

FILTER: LEVEL SCALING OFFSET

JOB 26

```

FL1\LS OFS1 EL1
+0 +0 +0 +0

```

Summary: Sets the amount of level offset for each of the four level-scaling breakpoints set in the "FILTER: LEVEL SCALING BREAKPOINT" function described above.

Settings: -127 ... +127

Procedure: Use the [←] and [→] cursor keys to select the desired offset parameter (OFS1, OFS2, OFS3 and OFS4, from left to right), then use the [DATA ENTRY] control, [-1/NO] and [+1/YES] keys, or numeric and [ENTER] keys to set the level-scaling offset for the corresponding breakpoint.

The filter 1 or filter 2 envelope generator can be selected by holding the [SELECT] key and pressing the numeric [9] or [6] key, respectively.

Details: Negative values reduce the level, and positive values increase the level at the corresponding breakpoint. No matter what value is chosen, the EG level will never exceed its maximum of 63.

When different offsets are set for adjacent breakpoints, the level varies accordingly and smoothly between the breakpoints.

Refer to: "FILTER: LEVEL SCALING BREAKPOINT" on page 76. "FILTER: CUTOFF ENVELOPE GENERATOR," page 75.

**FILTER: RESONANCE/VELOCITY SENSITIVITY/
MODULATION SENSITIVITY**

JOB 27

● **Resonance**

```

FL\Resonance EL1
  0 +6 +3

```

Summary: Determines the degree of resonance of filter 1 and filter 2.

Settings: 0 ... 99

Procedure: If the Resonance parameter is not already selected, use the [←] and [→] cursor keys to select it. Use the [DATA ENTRY] control, [-1/NO] and [+1/YES] keys, or numeric and [ENTER] keys to select the desired degree of resonance.

Details: This parameter has a similar effect to the "resonance" settings on traditional analog synthesizer filters — i.e. it determines the height of a peak in the filter response at the cutoff frequency.

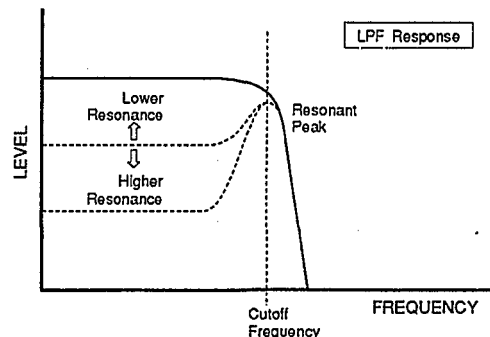

Higher resonance values produce a higher resonant peak and reduce the overall passband level.

Refer to: Tutorial, page 37, 45. "FILTER: TYPE/CUTOFF/MODE," page 73.

● Velocity Sensitivity

```
FL\Vel.Sens  EL1
             0  +6  +3
```

Summary: Determines how the filter 1 and filter 2 cutoff frequencies change in response to velocity changes (e.g. keyboard dynamics).

Settings: -7 ... +7

Procedure: Use the [◀] and [▶] cursor keys to select the Velocity Sensitivity ("Vel.Sens" on upper LCD line) parameter. Use the [DATA ENTRY] control, [-1/NO] and [+1/YES] keys, or numeric and [ENTER] keys to select the required degree of velocity sensitivity.

Details: Plus "+" settings produce higher cutoff frequencies in response to higher velocity values — i.e. the harder a key is played, the higher the cutoff frequency. The maximum setting of "+7" produces the maximum level variation in response to velocity changes. Minus "-" settings produce the opposite effect: lower cutoff in response to higher velocity. A setting of "+0" results in no cutoff variation.

Refer to: "FILTER: TYPE/CUTOFF/MODE," page 73.

● Modulation Sensitivity

```
FL\Mod.Sens  EL1
             0  +6  +3
```

Summary: Determines the sensitivity of the filter 1 and filter 2 cutoff frequency to modulation applied via the LFO and appropriate controllers.

Settings: -7 ... +7

Procedure: Use the [◀] and [▶] cursor keys to select the Modulation Sensitivity parameter ("Mod.Sens"). Use the [DATA ENTRY] control, [-1/NO] and [+1/YES] keys, or numeric and [ENTER] keys to set the required degree of modulation sensitivity.

Details:

Plus "+" settings produce higher cutoff frequencies in response to modulation — i.e. the greater

the modulation, the higher the cutoff frequency. The maximum setting of "+7" produces the maximum cutoff variation in response to modulation. Minus "-" settings produce the opposite effect: lower cutoff in response to modulation. A setting of "+0" results in no cutoff modulation.

When setting up the low-frequency oscillator or a controller to apply cutoff modulation, this parameter must be set to a value other than "0" for pitch modulation to take place.

Refer to: "LOW FREQUENCY OSCILLATOR (LFO) WAVEFORM/SPEED/DELAY/PHASE" on page 69. "LOW FREQUENCY OSCILLATOR MODULATION DEPTH, AMPLITUDE/PITCH/CUTOFF" on page 70. "CONTROLLER" functions from page 81 to page 84.

ELEMENT INITIALIZE **JOB 28**

```

Element      EL1
  Initialize
```

Summary: Initializes all parameters of the active element.

Settings: None

Procedure: After selecting the "ELEMENT Initialize" display, press the [ENTER] key. "Sure?" will appear on the upper line of the display. Press the [+1/YES] to initialize or [-1/NO] to cancel the initialize operation.

"Completed!" will appear briefly when the initialization is finished.

Details: When Element Initialize is executed, the element parameters are initialized to the following values:

The element initialize function is useful if you want to begin programming an element "from scratch."

Refer to: "VOICE INITIALIZE," page 90.

Jobs	Initialized Values			
AWM wave selection	P46 (Tri)			
Volume	127			
Note shift	+0			
Detune	+0			
Low note limit	C-2			
High note limit	G8			
Low velocity limit	1			
High velocity limit	127			
Panning	+0			
Effect balance	0			
Oscillator mode/note/tune	Mode norm	Note --	Tune +0	
AEG mode/level/rate	Mode nrm	R1 63	R2 63	L2 63
	R3 63	L3 63	R4 0	RR 63
AEG rate scaling	+0			
AEG level scalebreakpoint	BP1 C1	BP2 G2	BP3 E4	BP4 C6
AEG level scale offset	OFS1 +0	OFS2 +0	OFS3 +0	OFS4 +0
Sensitivity	Velocity +0	V. rate off	AMS +0	PMS 3
LFO waveform/speed/delay/phase	Wave tri	Speed 65	Delay 0	Phase 0
LFO modulation depth, amplitude/ pitch/cutoff	AMOD 0	PMOD 0	CutoffMOD 0	

Jobs	Initialized Values			
PEG level/rate	L0 +0	R1 63	L1 +0	
	R2 63	L2 +0	R3 63	L3 +0
	RR 63	RL +0		
PEG sensitivity, range/rate scaling/ velocity	Range 2oct	R. scale +0	Vel. SW off	
Filter: type/cutoff/mode	Type THU	Cutoff 127	Mode LFO	
Filter: cutoff envelope generator	L0 +0	R1 0	L1 +0	
	R2 0	L2 +0	R3 0	L3 +0
	R4 0	L4 +0	RR1 0	RL1 +0
	RR2 0	RL2 +0		
Filter: rate scaling	+0			
Filter: level scaling breakpoint	BP1 C1	BP2 G2	BP3 E4	BP4 C6
Filter: level scaling offset	OFS1 +0	OFS2 +0	OFS3 +0	OFS4 +0
Filter: resonance/velocity sensitivity/ modulation sensitivity	Resonance 0	Vel. sens +0	Mod.sens +0	

CONTROLLER: PITCH BEND RANGE

JOB 29

```
CNTL\Pitch Bend
Range = 2
```

Summary: Sets the maximum pitch bend range.

Settings: 0 ... 12

Procedure: Use the [DATA ENTRY] control, [-1/NO] and [+1/YES] keys, or numeric and [ENTER] keys to set the required pitch bend range.

Details: Each increment from "0" to "12" represents a semitone. A setting of "0" produces no pitch

bend. A setting of "12" allows a maximum pitch bend of plus or minus one octave, while a setting of "4" allows a maximum pitch bend of plus or minus a major third.

If the MIDI controller used is a keyboard, pitch bend is normally controlled via its pitch bend wheel.

CONTROLLER: AFTER TOUCH PITCH BIAS

JOB 30

```
CNTL\AT P.Bias
Range = +0
```

Summary: Sets the maximum pitch variation range achievable via after-touch control.

Settings: -12 ... +12

Procedure: Use the [DATA ENTRY] control, [-1/NO] and [+1/YES] keys, or numeric and [ENTER] keys to set the required after touch pitch bias range.

Details: Each increment represents a semitone. A setting of "0" produces no pitch variation. A setting of "+12" allows a maximum pitch variation of one octave up, while a setting of "-12" allows a maximum pitch variation of one octave down corresponding to after-touch key pressure.

CONTROLLER: RANDOM PITCH RANGE

JOB 31

```
CNTL\RandomPitch
Range = 0
```

Summary: Sets the amount of random pitch variation produced each time a note is played.

Settings: 0 ... 7

Procedure: Use the [DATA ENTRY] control, [-1/NO] and [+1/YES] keys, or numeric and [ENTER] keys to set the required random pitch range.

Details: When this function is set to a value other than "0," the pitch changes randomly each time

a note is played. The random pitch change is applied independently to each note in a chord. A setting of "7" produces the greatest amount of random pitch change.

This function is ideal for simulating the sound of instruments like the clavichord, string sections or other ensembles in which the pitch of each note is rarely in perfect tune with the others.

CONTROLLER: AMPLITUDE MODULATION

JOB 32

```
CNTL\AMOD :---  
CTL#= 0 RNG= 0
```

Summary: Assigns a controller to, and sets the maximum depth of amplitude modulation applied by the LFO.

Settings:

CTL# (Control Number) Parameter: 0 ... 120, AT

RNG (Range) Parameter: 0 ... 127

Procedure: Use the [◀] and [▶] keys to select the "CTL#" or "RNG" parameter, then use the [DATA ENTRY] control, [-1/NO] and [+1/YES] keys, or numeric and [ENTER] keys to set the selected parameter as required.

Details: The "CTL#" parameter corresponds to MIDI control numbers. Standard controller assignments are noted in the upper right-hand corner of the display:

Set the CTL# parameter to the number of the controller with which you intend to control this function.

The RNG parameter can be set to a value between 0 and 127. A setting of "0" produces no change when the assigned controller is operated, while a setting of "127" produces the maximum possible change.

If you assign a breath controller (CTL# 2) to amplitude modulation, for example, the harder you blow into the breath controller, the greater will be the depth of the amplitude modulation produced. Please note that the amplitude modulation sensitivity parameter described on page ?? must be set to an appropriate value before amplitude modulation will function.

Refer to: "SENSITIVITY (VELOCITY, AMPLITUDE & PITCH MODULATION)," page 67.

CONTROLLER: PITCH MODULATION

JOB 33

```
CNTL\PMOD :MOD  
CTL#= 1 RNG= 43
```

Summary: Assigns a controller to, and sets the maximum depth of pitch modulation applied by the LFO.

Settings:

CTL# (Control Number) Parameter: 0 ... 120, AT

RNG (Range) Parameter: 0 ... 127

Procedure: Use the [◀] and [▶] keys to select the "CTL#" or "RNG" parameter, then use the [DATA ENTRY] control, [-1/NO] and [+1/YES] keys, or numeric and [ENTER] keys to set the selected parameter as required.

Details: The "CTL#" parameter corresponds to MIDI control numbers. Standard controller assignments are noted in abbreviations shown in the upper right-hand corner of the display:

Set the CTL# parameter to the number of the controller with which you intend to control this function.

The RNG parameter can be set to a value between 0 and 127. A setting of "0" produces no change when the assigned controller is operated, while a setting of "127" produces the maximum possible change.

If you assign the modulation wheel (CTL# 1) to pitch modulation, for example, rolling the modulation wheel away from you will produce deeper pitch modulation. Please note that the pitch modulation sensitivity parameter described on page ?? must be set to an appropriate value before pitch modulation will function.

Refer to: "SENSITIVITY (VELOCITY, AMPLITUDE & PITCH MODULATION)," page 67.

CONTROLLER: CUTOFF MODULATION

JOB 34

```
CNTL\CoffMOD:---
CTL#= 0 RNG= 0
```

Summary: Assigns a controller to, and sets the maximum depth of filter cutoff modulation applied by the LFO.

Settings:

CTL# (Control Number) Parameter: 0 ... 120,
AT

RNG (Range) Parameter: 0 ... 127

Procedure: Use the [◀] and [▶] keys to select the "CTL#" or "RNG" parameter, then use the [DATA ENTRY] control, [-1/NO] and [+1/YES] keys, or numeric and [ENTER] keys to set the selected parameter as required.

Details: The "CTL#" parameter corresponds to MIDI control numbers. Standard controller assignments are noted in the upper right-hand corner of the display:

Set the CTL# parameter to the number of the controller with which you intend to control this function.

The RNG parameter can be set to a value between 0 and 127. A setting of "0" produces no change when the assigned controller is operated, while a setting of "127" produces the maximum possible change.

If you assign a foot controller (CTL# 4) to cutoff modulation, for example, pressing forward on the foot controller pedal increases the depth of the cutoff modulation. Please note that the cutoff modulation sensitivity parameter described on page 77 must be set to an appropriate value before cutoff modulation will function.

Refer to: "FILTER: RESONANCE/VELOCITY SENSITIVITY/MODULATION SENSITIVITY," page 77.

CONTROLLER: CUTOFF FREQUENCY CONTROL

JOB 35

```
CNTL\Cutoff : DE
CTL#= 6 RNG=127
```

Summary: Assigns a controller to, and sets the range of cutoff frequency control.

Settings:

CTL# (Control Number) Parameter: 0 ... 120,
AT

RNG (Range) Parameter: 0 ... 127

Procedure: Use the [◀] and [▶] keys to select the "CTL#" or "RNG" parameter, then use the [DATA ENTRY] control, [-1/NO] and [+1/YES] keys, or numeric and [ENTER] keys to set the selected parameter as required.

Details: The "CTL#" parameter corresponds to MIDI control numbers. Standard controller assignments are noted in the upper right-hand corner of the display:

Set the CTL# parameter to the number of the controller with which you intend to control this function.

The RNG parameter can be set to a value between 0 and 127. A setting of "0" produces no change when the assigned controller is operated, while a setting of "127" produces the maximum possible change.

If you assign a [DATA ENTRY] controller (CTL# 6) to cutoff frequency control, for example, higher [DATA ENTRY] controller settings will result in higher cutoff frequencies. You could assign a foot controller to cutoff frequency control to create wah-wah pedal type effects.

Refer to: "FILTER: RESONANCE/VELOCITY SENSITIVITY/MODULATION SENSITIVITY," page 77.

CONTROLLER: EG BIAS CONTROL

JOB 36

```
CNTL\EG Bias:---  
CTL#= 0 RNG= 0
```

Summary: Assigns a controller to, and sets the range of envelope generator bias control.

Settings:

CTL# (Control Number) Parameter: 0 ... 120,
AT

RNG (Range) Parameter: 0 ... 127

Procedure: Use the [←] and [→] keys to select the "CTL#" or "RNG" parameter, then use the [DATA ENTRY] control, [-1/NO] and [+1/YES] keys, or numeric and [ENTER] keys to set the selected parameter as required.

Details: The "CTL#" parameter corresponds to MIDI control numbers. Standard controller assignments are noted in the upper right-hand corner of the display:

Set the CTL# parameter to the number of the controller with which you intend to control this function.

The RNG parameter can be set to a value between 0 and 127: A setting of "0" produces no change when the assigned controller is operated, while a setting of "127" produces the maximum possible change.

If you assign a [DATA ENTRY] controller (CTL# 6) to EG bias control, for example, higher [DATA ENTRY] controller settings will result in higher EG levels. You could assign a breath controller to EG bias control to create tonguing and breath effects.

Refer to: "AMPLITUDE ENVELOPE GENERATOR (AEG) MODE/LEVEL/RATE," page 64.

CONTROLLER: VOLUME CONTROL

JOB 37

```
CNTL\Volume :---  
CTL#= 0 MIN= 0
```

Summary: Assigns a controller to, and sets the range of volume control.

Settings:

CTL# (Control Number) Parameter: 0 ... 120,
AT

MIN (Minimum) Parameter: 0 ... 127

Procedure: Use the [←] and [→] keys to select the "CTL#" or "MIN" parameter, then use the [DATA ENTRY] control, [-1/NO] and [+1/YES] keys, or numeric and [ENTER] keys to set the selected parameter as required.

Details:

The "CTL#" parameter corresponds to MIDI control numbers. Standard controller assignments are noted in the upper right-hand corner of the display:

Set the CTL# parameter to the number of the controller with which you intend to control this function.

The MIN parameter determines the minimum volume level that can be set using the assigned controller.

Normally the volume control (CTL# 7) will be assigned to this function, but you could assign a foot controller (CTL# 4) instead to allow foot-controlled swells and other expressive dynamics.

EFFECT: TYPE/OUTPUT LEVEL

JOB 38

● **Type**

```
EF\Type
1:Rev.Hall 100%
```

Summary: Selects one of 34 digital effects for the current voice.

Settings:

- 1: Rev.Hall (Reverb Hall)
- 2: Rev.Room (Reverb Room)
- 3: RevPlate (Reverb Plate)
- 4: RevChrch (Reverb Church)
- 5: Rev.Club (Reverb Club)
- 6: RevStage (Reverb Stage)
- 7: BathRoom (Reverb Bath Room)
- 8: RevMetal (Reverb Metal)
- 9: Delay (Single Delay)
- 10: DelayL/R (Stereo Delay)
- 11: St.Echo (Stereo Echo)
- 12: Doubler1 (Single Doubler)
- 13: Doubler2 (Stereo Doubler)
- 14: PingPong (Ping Pong Delay)
- 15: Pan Ref. (Pan Reflections)
- 16: EarlyRef (Early Reflections)
- 17: Gate Rev (Gate Reverb)
- 18: Rvs Gate (Reverse Gate)

- 19: FB E/R (Feedback Early Reflections)
- 20: FB Gate (Feedback Gate)
- 21: FB Rvs (Feedback Reverse)
- 22: Dly1&Rev (Delay 1 & Reverb)
- 23: Dly2&Rev (Delay 2 & Reverb)
- 24: Tunnel (Tunnel Reverb)
- 25: Tone 1 (Tone Control 1)
- 26: Dly1&T1 (Delay 1 & Tone Control 1)
- 27: Dly2&T1 (Delay 2 & Tone Control 1)
- 28: Tone 2 (Tone Control 2)
- 29: Dly1&T2 (Delay 1 & Tone Control 2)
- 30: Dly2&T2 (Delay 2 & Tone Control 2)
- 31: Dist&Rev (Distortion & Reverb)
- 32: Dst&Dly1 (Distortion & Delay 1)
- 33: Dst&Dly2 (Distortion & Delay 2)
- 34: Dist. (Distortion)

Procedure: If the Type parameter is not already selected, use the [←] and [→] cursor keys to select it. Use the [DATA ENTRY] control, [-1/NO] and [+1/YES] keys, or numeric and [ENTER] keys to select the desired effect.

Details: Each effect has three different editable parameters that allow the effect to be "customized" to suit you individual needs.

Refer to: "EFFECT: EFFECT PARAMETERS," page 86. Utility mode "EFFECT," page 133.

● **Output Level**

```
EF\Output Level
1:Rev.Hall 100%
```

Summary: Sets the level of the selected effect in relation to the direct (no effect) sound.

Settings: 0% ... 100%

Procedure: Use the [←] and [→] cursor keys to select the Output Level parameter. Use the [DATA ENTRY] control, [-1/NO] and [+1/YES] keys, or numeric and [ENTER] keys to set the desired output level.

Details: A setting of "0%" results in no effect, leaving only the "dry" sound of the voice. The maximum setting of "100%" applies the maximum amount of effect.

Refer to: Tutorial, page 25.

```

EF\Time      :sec
  1.2 thru   50

```

Summary: Accesses the individual programmable parameters for the selected effect.

Settings: The parameters and settings for each type of effect are different. See "Details" below.

Procedure: Use the [◀] and [▶] keys to select the desired parameter, then use the [DATA ENTRY] control or [+1/YES] and [-1/NO] keys to set its value.

Details: Brief descriptions of the parameters provided for each effect type are provided below:

1 ... 8: Reverb Effects

- Time: 0.3 ... 10 seconds
Sets the amount of time it takes for the reverb sound to decay to an inaudible level.
- LPF: 1.25 ... 12 kHz, Thru
Rolls off (attenuates) the high-frequency content of the reverb signal above the selected frequency. The LPF is OFF when set to THRU.
- Delay: 0.1 ... 50 milliseconds
Sets the delay time before the reverb sound begins.

9: Delay

- Time: 0.1 ... 300 milliseconds
Sets the delay time.
- FB Delay: 0.1 ... 300 milliseconds
Determines the amount of time before feedback is applied, and therefore the length of the initial delay before subsequent repeats begin.
- FB Gain: 0% ... 99%
Determines the amount of feedback returned to the input of the effect processor. Higher values produce a greater number of repeats.

10: Delay L/R

- Lch Delay: 0.1 ... 300 milliseconds
Sets the delay time of the left channel.
- Rch Delay: 0.1 ... 300 milliseconds
Sets the delay time of the right channel.

- FB Gain: 0% ... 99%
Determines the amount of feedback returned to the input of the effect processor. Higher values produce a greater number of repeats.

11: Stereo Echo

- Lch Delay: 0.1 ... 152 milliseconds
Sets the delay time of the left channel.
- Rch Delay: 0.1 ... 152 milliseconds
Sets the delay time of the right channel.
- FB Gain: 0% ... 99%
Determines the amount of feedback returned to the input of the effect processor. Higher values produce a greater number of repeats.

12: Doubler 1

- Delay: 0.1 ... 50 milliseconds
Sets the doubling delay.
- HPF: Thru, 160... 1000 Hertz
Rolls off (attenuates) the low-frequency content of the signal above the set frequency. The HPF is OFF when set to THRU.
- LPF: 1.25 ... 12 kilohertz. Thru
Rolls off (attenuates) the high-frequency content of the signal above the set frequency. The LPF is OFF when set to THRU.

13: Doubler 2

- Lch Delay: 0.1 ... 50 milliseconds
Sets the delay time of the left channel.
- Rch Delay: 0.1 ... 50 milliseconds
Sets the delay time of the right channel.
- LPF: 1.25 ... 12 kilohertz. Thru
Rolls off (attenuates) the high-frequency content of the signal above the set frequency. The LPF is OFF when set to THRU.

14: Ping Pong Delay

- Time: 0.1 ... 152 milliseconds
Sets the delay time.
- Pre-delay: 0.1 ... 152 milliseconds
Sets an initial delay time before the subsequent repeats begin.
- FB Gain: 0% ... 99%
Determines the amount of feedback returned to the input of the effect processor. Higher values produce a greater number of repeats.

15: Panned Reflections

- Room Size: 0.5 ... 3.2
Sets the separation between reflections. Higher values produce greater separation between reflections, and therefore the effect of a bigger room.
- FB Gain: 0% ... 99%
Determines the amount of feedback returned to the input of the effect processor. Higher values produce a greater number of reflections.
- Direction: L → R, R → L
Determines the direction of the pan sweep.

16: Early Reflections**17: Gate Reverb****18: Reverse Gate**

- Room Size: 0.5 ... 3.2
Sets the separation between reflections. Higher values produce greater separation between reflections, and therefore the effect of a bigger room.
- LPF: 1.25 ... 12 kilohertz, Thru
Rolls off (attenuates) the high-frequency content of the signal above the set frequency. The LPF is OFF when set to THRU.
- Delay: 0.1 ... 50 milliseconds
Sets the delay time before the early reflection sound begins.

19: Feedback Early Reflections**20: Feedback Gate****21: Feedback Reverse Gate**

- Room Size: 0.5 ... 3.2
Sets the separation between reflections. Higher values produce greater separation between reflections, and therefore the effect of a bigger room.
- LPF: 1.25 ... 12 kilohertz, Thru
Rolls off (attenuates) the high-frequency content of the signal above the set frequency. The LPF is OFF when set to THRU.
- FB Gain: 0% ... 99%
Determines the amount of feedback returned to the input of the effect processor. Higher values produce a greater number of rereflections.

22: Delay 1 & Reverb**24: Tunnel**

- Time: 0.3 ... 10 seconds
Sets the amount of time it takes for the reverb sound to decay to an inaudible level.
- Delay: 0.1 ... 152 milliseconds
Sets the delay time.
- FB Gain: 0% ... 99%
Determines the amount of feedback returned to the input of the effect processor. Higher values produce a greater number of delay repeats.

23: Delay 2 & Reverb

- Time: 0.3 ... 10 seconds
Sets the amount of time it takes for the reverb sound to decay to an inaudible level.
- Lch Delay: 0.1 ... 152 milliseconds
Sets the delay of the left channel.
- Rch Delay: 0.1 ... 152 milliseconds
Sets the delay of the right channel.

25: Tone Controls

- Low: -12...+12 dB
Sets the amount of boost or cut applied to the low frequencies. A setting of "0" produces no boost or cut. Minus values produce cut and plus values produce boost.
- Mid: -12 ... +12 dB
Sets the amount of boost or cut applied to mid-band frequencies. A setting of "0" produces no boost or cut. Minus values produce cut and plus values produce boost.
- High: -12...+12 dB
Sets the amount of boost or cut applied to the high frequencies. A setting of "0" produces no boost or cut. Minus values produce cut and plus values produce boost.

26: Delay 1 & Tone 1**27: Delay 2 & Tone 1****29: Delay 1 & Tone 2****30: Delay 2 & Tone 2**

- Brilliance: 0 ... 12
Determines the brilliance of the sound. Higher values produces a more brilliant, "sharper" sound.
- Delay: 0.1 ... 300 milliseconds
Sets the delay time.

- **FB Gain:** 0% ... 99%
Determines the amount of feedback returned to the input of the effect processor. Higher values produce a greater number of repeats.

28: Tone Controls 2

- **HPF:** Thru, 160 ... 1000 Hz
Rolls off (attenuates) the low-frequency content of the signal above the set frequency. The HPF is OFF when set to THRU.
- **Mid:** -12 ... +12 dB
Sets the amount of boost or cut applied to mid-band frequencies. A setting of "0" produces no boost or cut. Minus values produce cut and plus values produce boost.
- **LPF:** 1.25 ... 12.0 kilohertz. Thru
Rolls off (attenuates) the high-frequency content of the signal above the set frequency. The LPF is OFF when set to THRU.

31: Distortion & Reverb

- **Time:** 0.3 ... 10 seconds
Sets the amount of time it takes for the reverb sound to decay to an inaudible level.
- **Depth:** 0% ... 100%
Sets the degree of distortion produced. Higher values produce more distortion.
- **Balance:** 0% ... 100%
Sets the amount of reverb in relation to distortion. A setting of "0" produces distortion only, while a setting of "100" produces distortion plus maximum reverb. "50" produces an approximately even balance between the distortion and reverb sound.

32: Distortion & Delay 1

33: Distortion & Delay 2

- **Time:** 0.1 ... 300 milliseconds
Sets the delay time.
- **FB Gain:** 0% ... 99%
Determines the amount of feedback returned to the input of the effect processor. Higher values produce a greater number of repeats.
- **Depth:** 0% ... 100%
Sets the degree of distortion produced. Higher values produce more distortion.

34: Distortion

- **Level:** 0% ... 100%
Sets the degree of distortion produced. Higher values produce more distortion.
- **HPF:** Thru, 160 ... 1000 Hz
Rolls off (attenuates) the low-frequency content of the signal above the set frequency. The HPF is OFF when set to THRU.
- **LPF:** 1.25 ... 12.0 kilohertz, Thru
Rolls off (attenuates) the high-frequency content of the signal above the set frequency. The LPF is OFF when set to THRU.

Refer to: "EFFECT: TYPE/OUTPUT LEVEL," page 85. Utility mode "EFFECT," page 133.

VOICE NAME

JOB 40

```
VOICE Name
  "Grand"
```

Summary: Assigns a name of up to 10 characters to the current voice.

Settings: The following characters are available for use in voice names:

```
[Space] ! " # $ % & ' ( ) * + , - . / 0 1 2 3 4 5 6 7 8 9 : ; < = > ? @
A B C D E F G H I J K L M N O P Q R S T U V W X Y Z [ \ ] ^ _ `
a b c d e f g h i j k l m n o p q r s t u v w x y z ( | ) * +
```

Procedure: Use the [◀] and [▶] cursor keys to place the underline cursor under the character to be changed. Use the [DATA ENTRY] control or [+1/YES] and [-1/NO] keys to select the desired

character. Continue until the entire voice name has been programmed.

Details: It's a good idea to give your voices names that make the voice easily identifiable. If you've created a new voice that combines piano and organ waves, for example, you could call it something like "PianOrgan".

Refer to: Tutorial, page 46.

VOICE RECALL

JOB 41

```
VOICE Edit
  Recall
```

Summary: Recalls the last voice edited from the SY55 edit buffer.

Settings: None

Procedure: After selecting the "VOICE Edit Recall" display, press the [ENTER] key. "Sure?" will appear on the upper line of the display. Press the [+1/YES] to initialize or [-1/NO] to cancel the initialize operation.

"Completed!" will appear briefly when the recall operation is finished.

Details: Even if you've exited the voice edit mode and called a different voice, this function will recall the last voice edited with all parameters as they were at the time the voice edit mode was exited.

Please note, however, that a compare operation overwrites the recall buffer with the contents of the edit buffer at that time. A recall operation following a compare operation will therefore recall the contents of the edit buffer at the time of the compare operation.

Refer to: Tutorial, page 47.

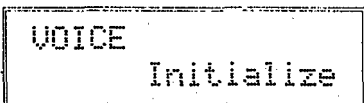

Summary: Initializes all parameters of the current voice.

Settings: None.

Procedure: After selecting the "VOICE Initialize" display, press the [ENTER] key. "Sure?" will appear on the upper line of the display. Press the [+1/YES] to initialize or [-1/NO] to-cancel the initialize operation.

"Completed!" will appear briefly when the initialization is finished.

Details: When Voice Initialize is executed, the voice parameters are initialized to the following values:

The voice initialize function is useful if you want to begin programming a voice "from scratch."

Refer to: Tutorial, page 42. "ELEMENT INITIALIZE," page 79.

Jobs	Initialized Values			
Voice mode	1 element			
AWM wave selection	P46 (Tri)			
Total volume	127			
Note shift	+0			
Detune	+0			
Low note limit	C-2			
High note limit	G8			
Low velocity limit	1			
High velocity limit	127			
Panning	+0			
Effect balance	0			
Oscillator mode/note/tune	Mode norm	Note	Tune +0	
AEG mode/level/rate	Mode nrm	R1 63	R2 63	L2 63
	R3 63	L3 63	R4 0	RR 63
AEG rate scaling	+0			
AEG level scale breakpoint	BP1 C1	BP2 G2	BP3 E4	BP4 C6
AEG level scale offset	OFS1 +0	OFS2 +0	OFS3 +0	OFS4 +0
Sensitivity	Velocity +0	V. rate off	AMS +0	PMS 3
LFO waveform/speed/delay/phase	Wave tri	Speed 65	Delay 0	Phase 0
LFO modulation depth, amplitude/ pitch/cutoff	AMOD 0	PMOD 0	CutoffMOD 0	

Jobs	Initialized Values			
PEG level/rate	L0	R1	L1	
	+0	63	+0	
	R2	L2	R3	L3
	63	+0	63	+0
	RR	RL		
	63	+0		
PEG sensitivity, range/rate scaling/ velocity	Range	R. scale	Vel. SW	
	2oct	+0	off	
Filter: type/cutoff/mode	Type	Cutoff	Mode	
	THU	127	LFO	
Filter: cutoff envelope generator	L0	R1	L1	
	+0	0	+0	
	R2	L2	R3	L3
	0	+0	0	+0
	R4	L4	RR1	RL1
	0	+0	0	+0
	RR2	RL2		
	0	+0		
Filter: rate scaling	+0			
Filter: level scaling breakpoint	BP1	BP2	BP3	BP4
	C1	G2	E4	C6
Filter: level scaling offset	OFS1	OFS2	OFS3	OFS4
	+0	+0	+0	+0
Filter: resonance/velocity sensitivity/ modulation sensitivity	Resonance	Vel. sens	Mod.sens	
	0	+0	+0	
Controller: pitch bend range	2			
Controller: after touch pitch bias	+0			
Controller: random pitch range	0			
Controller: amplitude modulation	CTL#	RNG		
	12	64		
Controller: pitch modulation	CTL#	RNG		
	1	64		
Controller: cutoff modulation	CTL#	RNG		
	1	0		
Controller: cutoff frequency control	CTL#	RNG		
	12	0		
Controller: EG bias control	CTL#	RNG		
	2	0		
Controller: volume control	CTL#	MIN		
	14	0		
Effect: type/output level	Type	Output level		
	1	100%		
Effect: time/LPF/delay	Time	LPF	Delay	
	2.6 sec	8.0 kHz	29 ms	
Voice name	INIT VOICE			

DRUM EDIT MODE

Contents

GENERAL OPERATION	93
Drum Voice Configuration	93
Selecting the Drum Edit Mode & Jobs/Edit Compare	93
The Drum Copy Function	94
The Effect Copy Function	95
JOBS & PARAMETERS	96
AWM WAVE SELECTION	96
VOLUME	96
NOTE SHIFT	97
TUNE	97
ALTERNATE GROUP	98
PANNING	98
EFFECT BALANCE	99
VOLUME CONTROL	100
EFFECT: TYPE/OUTPUT LEVEL	100
EFFECT: EFFECT PARAMETERS	101
DRUM SET VOICE NAME	101
DRUM SET VOICE RECALL	101
DRUM SET VOICE INITIALIZE	103

GENERAL OPERATION

Drum Voice Configuration

The drum voices — P63 and P64 — are composed of 61 elements each, corresponding to keys from C1 to C6 on the master keyboard or other MIDI controller. A different drum sound or other wave can thus be assigned to each key on the key-

board (i.e. to each drum element), making it possible to create different "drum set" configurations according to your musical requirements.

Keys C1 through C6 are initially programmed with the following voices for P63 and P64:

● Voice 63: Drum Set 1

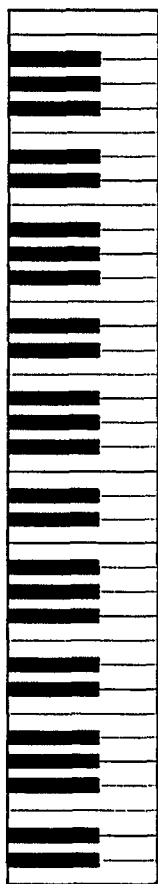

Key	Wave Name	No.	Key	Wave Name	No.
			C6	Syn Bass	P28
			B5	Syn Bass	P28
A#5	Syn Bass	P28	A5	Syn Bass	P28
G#5	Syn Bass	P28	G5	Syn Bass	P28
F#5	Syn Bass	P28	F5	Syn Bass	P28
			E5	Syn Bass	P28
D#5	Syn Bass	P28	D5	Syn Bass	P28
C#5	Syn Bass	P28	C5	Syn Bass	P28
			B4	Bulb	P57
A#4	Vocal Ga	P53	A4	Vocal Ga	P53
G#4	Bell Mix	P58	G4	Bottle	P51
F#4	Bottle	P51	F4	Bottle	P51
			E4	Styroll	P56
D#4	Shaker	P74	D4	Ride	P71
C#4	Bamboo	P54	C4	Vibe Np	P50
			B3	Vibe Np	P50
A#3	Claps	P72	A3	Claps	P72
G#3	Popping	P26	G3	Popping	P26
F#3	Tube	P52	F3	Tube	P52
			E3	Tube	P52
D#3	Ride	P71	D3	Ride	P71
C#3	Crash	P70	C3	Crash	P70
			B2	HH open	P69
A#2	Crash	P70	A2	HH closed	P68
G#2	Shaker	P74	G2	Cowbell	P73
F#2	Claps	P72	F2	Tom 1	P66
			E2	SD 1	P62
D#2	Rim	P65	D2	Tom 1	P66
C#2	SD 2	P63	C2	Tom 1	P66
			B1	Tom 1	P66
A#1	SD 3	P64	A1	BD 1	P59
G#1	BD 2	P60	G1	Tom 2	P67
F#1	Tom 2	P67	F1	Tom 2	P67
			E1	Tom 2	P67
D#1	BD 3	P61	D1	BD 3	P61
C#1	BD 2	P60	C1	BD 2	P60

● Voice 64: Drum Set 2

Key	Wave Name	No.	Key	Wave Name	No.
			C6	Syn Bass	P28
			B5	Syn Bass	P28
A#5	Syn Bass	P28	A5	Syn Bass	P28
G#5	Syn Bass	P28	G5	Syn Bass	P28
F#5	Syn Bass	P28	F5	Syn Bass	P28
			E5	Syn Bass	P28
D#5	Syn Bass	P28	D5	Syn Bass	P28
C#5	Syn Bass	P28	C5	Syn Bass	P28
			B4	Bulb	P57
A#4	Vocal Ga	P53	A4	Vocal Ga	P53
G#4	Bell Mix	P58	G4	Bottle	P51
F#4	Bottle	P51	F4	Bottle	P51
			E4	Styroll	P56
D#4	Shaker	P74	D4	Ride	P71
C#4	Bamboo	P54	C4	Vibe Np	P50
			B3	Vibe Np	P50
A#3	Claps	P72	A3	Claps	P72
G#3	Popping	P26	G3	Popping	P26
F#3	Tube	P52	F3	Tube	P52
			E3	Tube	P52
D#3	Ride	P71	D3	Ride	P71
C#3	Crash	P70	C3	Crash	P70
			B2	HH open	P69
A#2	Crash	P70	A2	HH closed	P68
G#2	Shaker	P74	G2	Cowbell	P73
F#2	Claps	P72	F2	Tom 2	P67
			E2	SD 2	P63
D#2	Rim	P65	D2	Tom 2	P67
C#2	SD 1	P62	C2	Tom 2	P67
			B1	Tom 2	P67
A#1	SD 3	P64	A1	BD 2	P60
G#1	BD 1	P59	G1	Tom 1	P66
F#1	Tom 1	P66	F1	Tom 1	P66
			E1	Tom 1	P66
D#1	BD 3	P61	D1	BD 3	P61
C#1	BD 1	P59	C1	BD 1	P59

DRUM EDIT MODE

Selecting the Drum Edit Mode & Jobs/Edit Compare

The drum edit mode and its various jobs are selected in exactly the same way as in the voice edit mode — the only difference being that a drum voice must be selected before the edit mode is engaged. See "Selecting the Voice Edit Mode", and "Select-

ing the Various Voice Edit Mode Jobs" on page 52. The Edit/Compare function also works with the drum edit mode — see "Edit Compare Operation" on page 54.

The Drum Copy Function

The Drum Copy function makes it possible to copy the parameter assignments from any other drum element to the drum element currently being edited. This is useful if, for example, you want to create a set of pitched tom-toms. You can copy a single tom-tom sound to as many drum elements as necessary — complete with all necessary parameter settings — and then simply change the pitch of each using the TUNE function.

1. Make sure the drum edit mode is engaged and that any function other than one of the EFFECT functions, DRUM NAME, DRUM RECALL, or DRUM INITIALIZE is selected.
2. Select the drum element to which the new parameter data will be copied by pressing the appropriate key on the master keyboard.
3. Press the [STORE/COPY] key. The following display will appear.

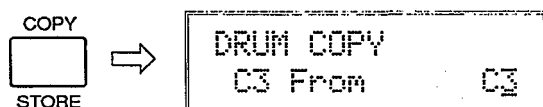

Next, select the drum element from which the parameter data is to be copied by pressing the appropriate key on the master keyboard, by using the [DATA ENTRY] control, or using the [+1/YES] and [-1/NO] keys. The name of the selected drum element will appear to the right of the bottom LCD line.

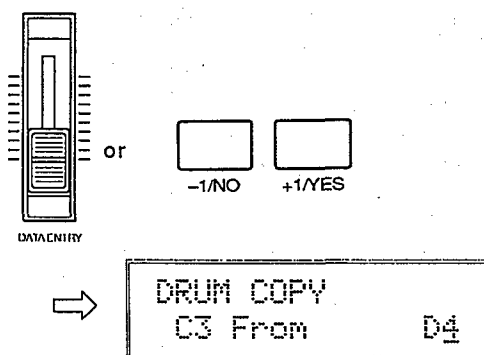

5. When the drum element to and from which the data is to be copied have been properly selected, press the [ENTER] key. "Sure?" will appear on the top line of the LCD.

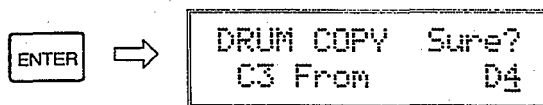

6. Press the [+1/YES] key to confirm and actually execute the copy operation, or [-1/NO] to cancel. "Completed!" will appear for a few seconds when the copy operation has been successfully completed.

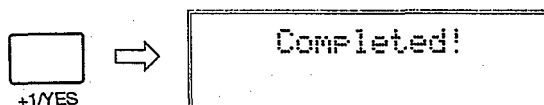

7. When the copy operation has finished, the SY55 will return automatically to the display that was showing immediately prior to activation of the drum copy function.

The Effect Copy Function

The Effect Copy function makes it possible to copy the effect parameter assignments from any other voice or multi-timbral setup to the drum voice currently being edited.

1. Make sure the drum edit mode is engaged and that one of the EFFECT functions is selected.
2. Press the [STORE/COPY] key. The following display will appear.

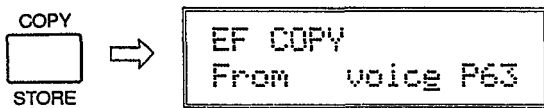

3. Use the [←] and [→] cursor keys to move to the Multi/Voice parameter and select "multi" if you want to copy effect parameters from a multi-timbral setup, or "voice" if you want to copy the effect parameters from a preset or internal voice.
4. Next, the cursor to the multi or voice number parameter by pressing the [→] key, and select the multi-timbral setup or voice from which the parameter data is to be copied by using the [DATA ENTRY] control, [-1/NO] and [+1/YES] keys, or numeric and [ENTER] keys. The [INTERNAL], [CARD], or [PRESET] key can be used to select the "P" (preset) or "I" (internal) voice bank if necessary — or, if a properly formatted memory card is inserted in the DATA card slot, the "C" or " " card bank.

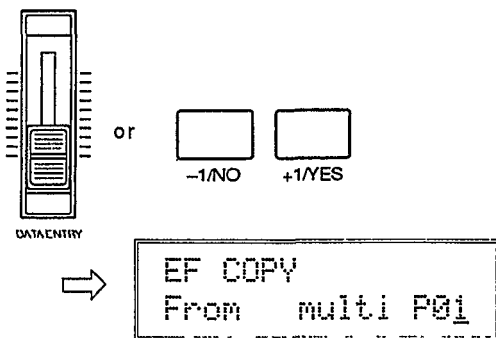

5. Press the [ENTER] key. "Sure?" will appear on the top line of the LCD.

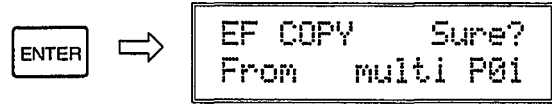

6. Press the [+1/YES] key to confirm and actually execute the copy operation, or [-1/NO] to cancel. "Executing!" will appear briefly on the display while the data is being copied, then "Completed!" will appear for a few seconds when the copy operation has been successfully completed.

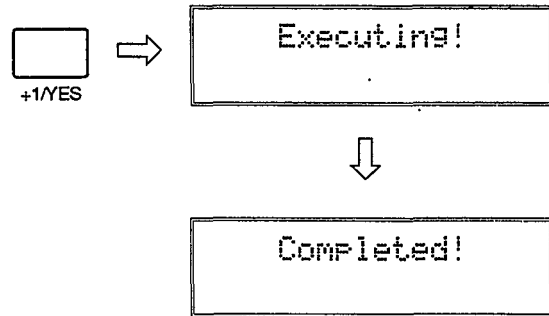

7. When the copy operation has finished, the SY55 will return automatically to the display that was showing immediately prior to activation of the effect copy function.

DRUM EDIT MODE

JOB 1

JOBS & PARAMETERS

AWM WAVE SELECTION

JOB 1

```
DRUM Wave Assign
C3:Crash   =P70
```

Summary: Assigns a preset or cartridge wave to each key (drum element) between C1 and C6.

Settings:

off, P01 ... P58 (preset voices)
P59 ... P74 (preset drums)
off, C01 ... max. C99 (cartridge voices)

Procedure: Select the drum element to which the new wave will be assigned (C1 ... C6) by pressing the appropriate key on the keyboard.

It is also possible to select the drum element to be edited by moving the cursor to the key name position by pressing the [↵] key and then using the [DATA ENTRY] control or [+1/YES] and [-1/NO] keys.

Once the desired drum element has been selected, move the cursor to the wave name position (if it is not already there) by pressing the [↵] cursor key, then use the [DATA ENTRY] control, [-1/NO] and [+1/YES] keys, or numeric and [ENTER] keys to assign the desired wave to the selected drum element.

The [PRESET] or [CARD] key can be used to select the "P" (PRESET) or "C" (CARD) memory bank.

Details: Note that in addition to drum sounds any other waves may be assigned to the drum elements. This makes it possible to include other non-drum waves in your original drum sets.

Drum elements can also be turned "off" (unassigned). The "off" setting can be selected by decrementing below the lowest-numbered wave.

Refer to: Tutorial, page 18, 35.

VOLUME

JOB 2

```
DRUM Volume  127
C3:Crash     =127
```

Summary: Allows the volume of individual drum elements to be adjusted, as well as the overall volume of the current drum voice.

Settings: 0 ... 127

Procedure: Select the drum element to be edited (C1 ... C6) by pressing the appropriate key on the keyboard.

It is also possible to select the drum element to be edited by moving the cursor to the key name position by pressing the [↵] key and then using the [DATA ENTRY] control or [+1/YES] and [-1/NO] keys.

Once the desired drum element has been selected, use the [↵] and [↶] cursor keys to move

the cursor to the volume parameter on the bottom line of the LCD to adjust individual volume, or the volume parameter on the upper line of the LCD to adjust overall volume.

Use the [DATA ENTRY] control, [-1/NO] and [+1/YES] keys, or numeric and [ENTER] keys to set the desired volume level.

Details: A setting of "0" produces no sound while a setting of "127" produces maximum volume.

The ability to independently adjust the volume of each drum element makes it simple to set up the optimum balance or "mix" between instruments in the drum set. Overall volume adjustment can be used to match the the overall level of different voices.

NOTE SHIFT

JOB 3

```

DRUM Note Shift
C3:Crash    = +4

```

Summary: Individually shifts the pitch of each drum element up or down in semitone steps.

Settings: -48 ... +36

Procedure: Select the drum element to be edited (C1 ... C6) by pressing the appropriate key on the keyboard.

It is also possible to select the drum element to be edited by moving the cursor to the key name position by pressing the [◀] key and then using the [DATA ENTRY] control or [+1/YES] and [-1/NO] keys.

Once the desired drum element has been selected, use the [◀] and [▶] cursor keys to move the cursor to the note shift parameter.

Use the [DATA ENTRY] control, [-1/NO] and [+1/YES] keys, or numeric and [ENTER] keys to set the desired degree of note shift.

Details: A setting of "-12," for example, shifts the pitch of the selected drum element down by one octave; a setting of "+4" shifts the pitch up by a major third.

In a drum voice, the note shift function can be used to create pitched sets of tom-toms or other instruments.

DRUM EDIT MODE

TUNE

JOB 4

```

DRUM Tune
C3:Crash    = +0

```

Summary: Allows each individual drum element to be tuned over approximately a 150-cent range.

Settings: -64 ... +63

Procedure: Select the drum element to be edited (C1 ... C6) by pressing the appropriate key on the keyboard.

It is also possible to select the drum element to be edited by moving the cursor to the key name position by pressing the [◀] key and then using the [DATA ENTRY] control or [+1/YES] and [-1/NO] keys.

Once the desired drum element has been selected, use the [◀] and [▶] cursor keys to move the cursor to the tuning parameter.

Use the [DATA ENTRY] control, [-1/NO] and [+1/YES] keys, or numeric and [ENTER] keys to set the desired tuning value.

Details: Each tuning increment corresponds to a 75/64-cent change in pitch. The entire tuning range is therefore $75/64 \times 127$ (i.e. 64 + 63 increments) — almost 150 cents. Since 100 cents equals one semitone, the tuning range is approximately one and a half semitones. A setting of "0" produces normal pitch.

ALTERNATE GROUP

JOB 5

```
DRUM Alt. Group
C3:Crash =off
```

Summary: Specifies drum elements which may not sound at the same time.

Settings: On, Off

Procedure: Select the drum element to be edited (C1 ... C6) by pressing the appropriate key on the keyboard.

It is also possible to select the drum element to be edited by moving the cursor to the key name position by pressing the [\leftarrow] key and then using the [DATA ENTRY] control, [-1/NO] and [+1/YES] keys, or numeric and [ENTER] keys.

Once the desired drum element has been selected, use the [\leftarrow] and [\rightarrow] cursor keys to move the cursor to the alternate group parameter.

Use the [DATA ENTRY] control or [+1/YES] and [-1/NO] keys to turn alternate grouping "on" or "off."

Details: In a real drum set, you would never hear the sound of a closed hi-hat at the same time as the open hi-hat. If you turn alternate group "on" for both of these instruments (which are really different sounds produced by the same instrument), the closed and open hi-hat elements will not sound together even if their keys are played at the same time.

This also means that you can play the open hi-hat, then "close" the hi-hat before the open hi-hat sound ends by playing the closed hi-hat key.

PANNING

JOB 6

```
DRUM Pan L.....R
C3:Crash =-15
```

Summary: Determines the position in the stereo sound field in which the sound from each drum element will be heard (left to right).

Settings: -31 ... +31

Procedure: Select the drum element to be edited (C1 ... C6) by pressing the appropriate key on the keyboard.

It is also possible to select the drum element to be edited by moving the cursor to the key name position by pressing the [\leftarrow] key and then using the [DATA ENTRY] control or [+1/YES] and [-1/NO] keys.

Once the desired drum element has been selected, use the [\leftarrow] and [\rightarrow] cursor keys to move the cursor to the pan parameter.

Use the [DATA ENTRY] control, [-1/NO] and [+1/YES] keys, or numeric and [ENTER] keys to set the desired pan value.

The upper line of the display also shows a graphic representation of the stereo sound field with "L" representing "left" and "R" representing "right." As you change the pan value the vertical bar will appear at the corresponding position on the graphic display.

Details: Minus values represent panning to the left, and positive values represent panning to the right. "0" positions the sound of the selected drum element in the center of the stereo sound field.

Refer to: "THE CONTROLS AND CONNECTORS," page 7.

EFFECT BALANCE

JOB 7

```

DRUM EF Balance
C3=Crash = 10

```

Summary: Determines the balance between the direct and effect sound for each drum element.

Settings: 0 ... 100

Procedure: Select the drum element to be edited (C1 ... C6) by pressing the appropriate key on the keyboard.

It is also possible to select the drum element to be edited by moving the cursor to the key name position by pressing the [↵] key and then using the [DATA ENTRY] control or [+1/YES] and [-1/NO] keys.

Once the desired drum element has been selected, use the [↵] and [⇨] cursor keys to move the cursor to the effect balance parameter.

Use the [DATA ENTRY] control, [-1/NO] and [+1/YES] keys, or numeric and [ENTER] keys to set the desired effect balance value.

Details: A setting of "0" produces only the direct sound of the selected drum element, while a setting of "100" produces only the effect sound. A setting of "50" delivers both the direct and effect sound in approximately equal proportions.

The effect (reverb, delay, etc.) applied to the voice is selected and edited using the EFFECT functions described on page 86.

Refer to: "EFFECT: TYPE/OUTPUT LEVEL" on page 85. "EFFECT: EFFECT PARAMETERS" on page 86.

VOLUME CONTROL

JOB 8

```

DRUM Volume :---
CTL#= @ MIN= 0

```

Summary: Assigns a controller to, and sets the range of volume control for the current drum voice.

Settings:

CTL# (Control Number) Parameter: 0 ... 120,
AT

MIN (Minimum Volume) Parameter: 0 ... 127

Procedure: Use the [↵] and [⇨] keys to select the "CTL#" or "MIN" parameter, then use the [DATA ENTRY] control, [-1/NO] and [+1/YES] keys, or numeric and [ENTER] keys to set the selected parameter as required.

Details: The "CTL#" parameter corresponds to MIDI control numbers. Standard controller assignments are noted in the upper right-hand corner of the display:

Set the CTL# parameter to the number of the controller with which you intend to control this function.

The MIN parameter can be set to a value between 0 and 127: A setting of "0" allows volume control over the full 0 ... 127 range, while a setting of "100," for example, allows volume control over only a small portion of the total range — 100 ... 127.

Please note that different controllers may be assigned to the normal and drum voices, so that they can be controlled independently.

EFFECT: TYPE/OUTPUT LEVEL

JOB 9

● Type

```
EF\Type
1:Rev.Hall 100%
```

Summary: Selects one of 34 digital effects for the current drum voice.

Settings and operation are exactly the same as in the voice edit mode: refer to "EFFECT: TYPE/OUTPUT LEVEL" on page 85.

● Output Level

```
EF\Output Level
1:Rev.Hall 100%
```

Summary: Sets the level of the selected drum voice effect in relation to the direct (no effect) sound.

Settings and operation are exactly the same as in the voice edit mode: refer to "EFFECT: TYPE/OUTPUT LEVEL" on page 85.

EFFECT: EFFECT PARAMETERS

JOB 10

```
EF\Time      :sec
 2.6  8.0  29
```

Summary: Accesses the individual programmable parameters for the selected drum voice effect.

Settings and operation are exactly the same as in the voice edit mode: refer to "EFFECT: EFFECT PARAMETERS" on page 86.

DRUM SET VOICE NAME

JOB 11

```

DRUM Name
  "Drum Set 1"
    
```

Summary: Assigns a name of up to 10 characters to the current drum voice.

Settings: The following characters are available for use in voice names:

```

[Space] ! " # $ % & ' ( ) * + , - . / 0 1 2 3 4 5 6 7 8 9 : ; / = : ? ?
ABCDEFGHIJKLMNOPQRSTUVWXYZ [ ] ^ _ `
abcdefghijklmnopqrstuvwxyz 1 2 3 4 5 6 7 8 9 : ; / = : ? ?
    
```

Procedure: Use the [←] and [→] cursor keys to place the underline cursor under the character to be changed. Use the [DATA ENTRY] control or [+1/YES] and [-1/NO] keys to select the desired character. Continue until the entire drum voice name has been programmed.

Details: It's a good idea to give your voices names that make the voice easily identifiable. If you've created a new drum voice designed specifically for a jazzy sound, for example, you could call it something like "Jazz Set".

DRUM EDIT MODE

DRUM SET VOICE RECALL

JOB 12

```

DRUM Edit
  Recall
    
```

Summary: Recalls the last drum voice edited from the SY55 edit buffer.

Settings: None

Procedure: After selecting the "DRUM Edit Recall" display, press the [ENTER] key. "Sure?" will appear on the upper line of the display. Press the [+1/YES] to initialize or [-1/NO] to cancel the initialize operation.

"Completed!" will appear briefly when the recall operation is finished.

Details: Even if you've exited the drum edit mode and called a different voice, this function will recall the last drum-set voice edited with all parameters as they were at the time the drum edit mode was exited.

Please note, however, that a compare operation overwrites the recall buffer with the contents of the edit buffer at that time. A recall operation following a compare operation will therefore recall the contents of the edit buffer at the time of the compare operation.

DRUM SET VOICE INITIALIZE

JOB 13

DRUM
Initialize

Summary: Initializes all parameters of the current drum voice.

Settings: None.

Procedure: After selecting the "DRUM Initialize" display, press the [ENTER] key. "Sure?" will appear on the upper line of the display. Press the [+1/YES] to initialize or [-1/NO] to cancel the initialize operation.

"Completed!" will appear briefly when the initialization is finished.

Details: When Drum Initialize is executed, the drum voice parameters are initialized to the following values:

The drum voice initialize function is useful if you want to begin programming a new drum set voice "from scratch."

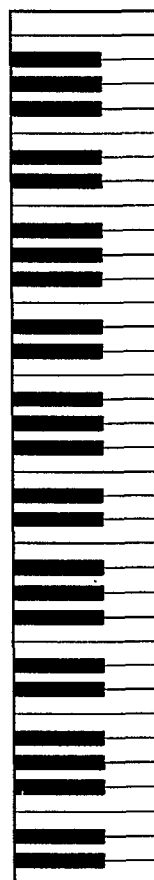

● INIT DRUM

Key	Wave Name	No.	Key	Wave Name	No.
			C6	Syn Bass	P28
A#5	Syn Bass	P28	B5	Syn Bass	P28
G#5	Syn Bass	P28	A5	Syn Bass	P28
F#5	Syn Bass	P28	G5	Syn Bass	P28
			F5	Syn Bass	P28
D#5	Syn Bass	P28	E5	Syn Bass	P28
C#5	Syn Bass	P28	D5	Syn Bass	P28
			C5	Syn Bass	P28
A#4	Vocal Ga	P53	B4	Bulb	P57
G#4	Bell Mix	P58	A4	Vocal Ga	P53
F#4	Bottle	P51	G4	Bottle	P51
			F4	Bottle	P51
D#4	Shaker	P74	E4	Styroll	P56
C#4	Bamboo	P54	D4	Ride	P71
			C4	Vibe Np	P50
A#3	Claps	P72	B3	Vibe Np	P50
G#3	Popping	P26	A3	Claps	P72
F#3	Tube	P52	G3	Popping	P26
			F3	Tube	P52
D#3	Ride	P71	E3	Tube	P52
C#3	Crash	P70	D3	Ride	P71
			C3	Crash	P70
A#2	Crash	P70	B2	HH open	P69
G#2	Shaker	P74	A2	HH closed	P68
F#2	Claps	P72	G2	Cowbell	P73
			F2	Tom 1	P66
D#2	Rim	P65	E2	SD 1	P62
C#2	SD 2	P63	D2	Tom 1	P66
			C2	Tom 1	P66
A#1	SD 3	P64	B1	Tom 1	P66
G#1	BD 2	P60	A1	BD 1	P59
F#1	Tom 2	P67	G1	Tom 2	P67
			F1	Tom 2	P67
D#1	BD 3	P61	E1	Tom 2	P67
C#1	BD 2	P60	D1	BD 3	P61
			C1	BD 2	P60

MULTI EDIT MODE

Contents

GENERAL OPERATION	105
Multi Mode Configuration	105
Selecting the Multi Edit Mode & Jobs/Edit Compare	105
The Channel Copy Function	106
The Effect Copy Function	107
JOBS & PARAMETERS	108
VOICE SELECTION	108
VOLUME	108
NOTE SHIFT	109
TUNE	109
RESERVED NOTE	110
PANNING	110
EFFECT LEVEL	111
EFFECT: SOURCE	111
EFFECT: TYPE/OUTPUT LEVEL	112
EFFECT: EFFECT PARAMETERS	112
MULTI NAME	113
MULTI RECALL	113
MULTI INITIALIZE	114

GENERAL OPERATION

Multi Mode Configuration

In the multi edit mode 16 different voices can be assigned to the 16 MIDI channels. The assigned voices can then be individually controlled over the appropriate channels from an external MIDI sequence recorder or other controller.

Since the SY55 can produce a maximum of 16 notes at the same time (16-note polyphony), the number of simultaneous notes that each voice can produce depends on the number of voices being played at the time. If 16 single-element voices are

played at once, for example, each can only produce a single note. On the other hand, if only one voice is being played the SY55's "Dynamic Note Allocation" feature allows 16 notes to be played simultaneously by that one voice even if 16 voices are assigned.

The SY55 also has a RESERVED NOTE function that allows you to specify a minimum number of notes for each voice.

Selecting the Multi Edit Mode & Jobs/Edit Compare

The multi edit mode and its various jobs are selected in exactly the same way as in the voice edit mode — the only difference being that the MULTI play mode must be selected by pressing the [MULTI] key before the edit mode is engaged. See "Selecting the Voice Edit Mode", and "Selecting the Various

Voice Edit Mode Jobs" on page 52. The Edit/Compare function also works with the multi edit mode — see "Edit Compare Operation" on page 54.

The Channel Copy Function

The Channel Copy function makes it possible to copy the parameter assignments from any other multi-play channel to the channel currently being edited.

1. Make sure the multi edit mode is engaged and that any function other than one of the EFFECT functions, MULTI NAME, MULTI RECALL, or MULTI INITIALIZE is selected.
2. Select the channel to which the new parameter data will be copied by using the [←] and [→] cursor keys. The selected channel number is shown at the right end of the upper line of the LCD (CH1 ... CH16).
3. Press the [STORE/COPY] key. The following display will appear.



Next, select the channel from which the parameter data is to be copied by using the [DATA ENTRY] control, [-1/NO] and [+1/YES] keys, or numeric and [ENTER] keys. The number of the selected channel will appear to the right of the bottom LCD line.

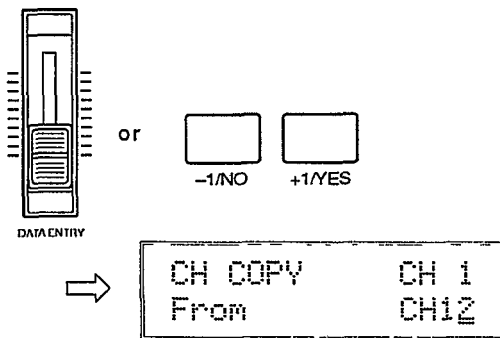

4. When the channels to and from which the data is to be copied have been properly selected, press the [ENTER] key. "Sure?" will appear on the top line of the LCD.

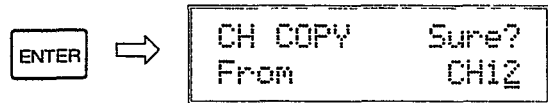

5. Press the [+1/YES] key to confirm and actually execute the copy operation, or [-1/NO] to cancel. "Completed!" will appear for a few seconds when the copy operation has been successfully completed.

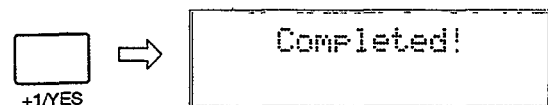

6. When the copy operation has finished, the SY55 will return automatically to the display that was showing immediately prior to activation of the channel copy function.

The Effect Copy Function

The Effect Copy function makes it possible to copy the effect parameter assignments from any other voice or multi-play setup to the multi-play setup currently being edited.

1. Make sure the multi edit mode is engaged and that one of the EFFECT functions is selected.
2. Press the [STORE/COPY] key. The following display will appear.

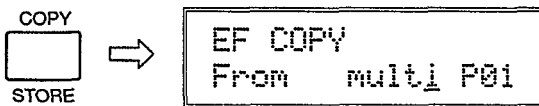

3. Use the [←] and [→] cursor keys to move to the multi/voice parameter and select "multi" if you want to copy the effect parameters from another multi-play setup, or "voice" if you want to copy the effect parameters from a preset or internal voice.
4. Next, move the cursor to the multi or voice number parameter by pressing the [↵] key, and select the multi-play setup or voice from which the parameter data is to be copied by using the [DATA ENTRY] control, [-1/NO] and [+1/YES] keys, or numeric and [ENTER] keys. The [INTERNAL], [CARD] or [PRESET] key can be used to select the "P" (preset) or "I" voice bank if necessary — or, if a properly formatted memory card is inserted in the DATA card slot, the "C" or " " card bank.

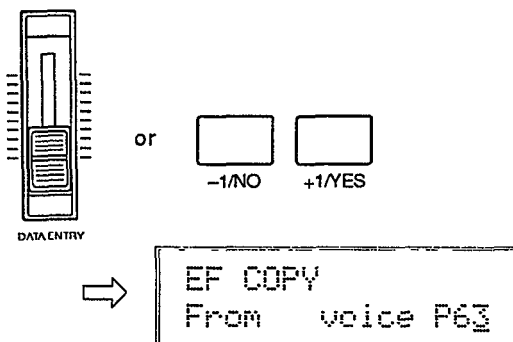

5. Press the [ENTER] key. "Sure?" will appear on the top line of the LCD.



6. Press the [+1/YES] key to confirm and actually execute the copy operation, or [-1/NO] to cancel. "Completed!" will appear for a few seconds when the copy operation has been successfully completed.

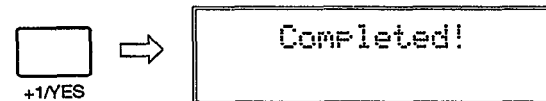

7. When the copy operation has finished, the SY55 will return automatically to the display that was showing immediately prior to activation of the effect copy function.

JOB 1

JOBS & PARAMETERS

VOICE SELECTION

JOB 1

```
<Piano >CH 1
#P01 P02 P03 P04
```

Summary: Assigns a preset or internal voice to each MIDI channel.

Settings:

off, P01 ... P64 (preset voices)
101 ... 164 (internal voices)
C01 ... C64 (card voices)

Procedure: Use the [←] and [→] cursor keys are used to move the cursor to the desired channel (a channel number between CH1 and CH16 will appear in the upper right-hand corner of the display), and then use the [DATA ENTRY] control, [-1/NO] and [+1/YES] keys, or numeric and [ENTER] keys to assign the desired voice to the selected channel.

If you have selected a preset or internal multi-play setup, use the [PRESET] or [INTERNAL] key to select the "P" (preset) or "I" (internal) voice bank for each channel, as necessary.

Or, if you have selected a card multi-play setup, use the [PRESET] or [CARD] key to select the "P" (preset) or "C" (card) voice bank for each channel, as necessary (internal voices cannot be selected for card multi-play setups).

By decrementing below the lowest voice (P01 or I01), the assignment for the current channel can be turned "off."

Details: The bank character ("P" or "I") of the voice currently selected in the voice mode is shown in reverse (i.e. white character on black background). The voice-mode voice can be switched to any voice assigned in this function by moving the cursor to the appropriate voice position and then pressing the [SELECT] key. The bank character of the newly selected voice-mode voice will then appear in reverse.

When the cursor is placed at the voice-mode voice number position, a reverse letter "E" will appear to the left of the channel number if the voice has been edited. In this case, the sound produced will be that of the edited voice.

Refer to: Tutorial, page 22.

VOLUME

JOB 2

```
Volume CH 1
#127 127 127 127
```

Summary: Allows individual volume adjustment of the voice assigned each multi-play channel.

Settings: 0 ... 127

Procedure: The [←] and [→] cursor keys are used to select the channel/voice for which the volume is to be adjusted. The [DATA ENTRY] control, [-1/NO] and [+1/YES] keys, or numeric and [ENTER] keys are used to set the desired volume.

Details: A setting of "0" produces no sound while a setting of "127" produces the maximum volume available with the individual volume setting of that voice.

The ability to independently adjust the volume of each voice makes it simple to set up the optimum balance or "mix" between voices.

Refer to: Tutorial, page 23.

NOTE SHIFT

JOB 3

```

Note Shift CH 1
┌ +0 +0 +0 +0

```

Summary: Individually shifts the pitch of the voice assigned to each multi-play channel up or down in semitone steps.

Settings: -64 ... +63.

Procedure: The [◀] and [▶] cursor keys are used to select the channel/voice to be note-shifted. The [DATA ENTRY] control, [-1/NO] and [+1/YES] keys, or numeric and [ENTER] keys are used to set the desired degree of note shift.

Details: A setting of "-12," for example, shifts the pitch of the selected voice down by one octave; a setting of "+4" shifts the pitch up by a major third.

The Note Shift function can be used to transpose a voice to its most useful range, or to create harmony (intervals) between different voices in a multi-play setup.

TUNE

JOB 4

```

Tune CH 1
┌ +0 +0 +0 +0

```

Summary: Allows each individual voice to be tuned over approximately a 150-cent range,

Settings: -64 ... +63

Procedure: The [◀] and [▶] cursor keys are used to select the voice/channel to be tuned. The [DATA ENTRY] control, [-1/NO] and [+1/YES] keys, or numeric and [ENTER] keys are used to set the desired degree of tuning.

Details: Each tuning increment corresponds to a 75/64-cent change in pitch. The entire tuning range is therefore $75/64 \times 127$ (i.e. 64 + 63 increments) — almost 150 cents. Since 100 cents equals one semitone, the tuning range is approximately one and a half semitones. A setting of "0" produces normal pitch.

RESERVED NOTE

JOB 5

```
ReserveNote CH 1
* 0 0 0 0
```

Summary: Reserves a minimum number of notes to be played simultaneously by each voice.

Settings: 0 ... 16

Procedure: The [←] and [→] cursor keys are used to select the voice/channel, then the [DATA ENTRY] control, [-1/NO] and [+1/YES] keys, or numeric and [ENTER] keys are used to set the number of reserved notes.

Details: The main use for this function is to ensure that a minimum number of notes are available to specific instruments even under circumstances in which less would normally be available. For example, if 1-element voices assigned to all 16 channels are played at once, each can only produce a single note. If one of those voices is an important piano voice that should be playing at least 3-note chords, for example, then the overall sound will be ruined. This problem can be

overcome by setting the piano voice reserved note parameter to "3" so that the piano voice always has at least 3 notes available. This occurs, however, at the expense of the other voices, and if all 16 voices are played simultaneously (with the piano playing a 3-note chord), two of the instruments will not sound at all. You can specify which instruments should be sacrificed in such a case by setting the piano to "3" and all but two of the remaining instruments to "1." The remaining two instruments, set to "0," will be the ones that don't sound when a full complement of 16 notes is received.

Please keep in mind the fact that the SY55 can produce a maximum of 16 notes simultaneously no matter how this function is set. The total number of reserved notes set for all channels should not exceed 16.

Refer to: Tutorial, page 24.

PANNING

JOB 6

```
Pan L.....R CH 1
* +0 +0 +0 +0
```

Summary: Determines the position in the stereo sound field in which the sound from each voice/channel will be heard (left to right).

Settings: vce, -31 ... +31

Procedure: The [←] and [→] cursor keys are used to select the voice/channel for which the pan position is to be set. The [DATA ENTRY] control, [-1/NO] and [+1/YES] keys, or numeric and [ENTER] keys are used to set the pan position.

The upper line of the display also shows a graphic representation of the stereo sound field

with "L" representing "left" and "R" representing "right." As you change the pan value the vertical bar will appear at the corresponding position on the graphic display. If the "VCE" setting is selected, the original pan setting of the voice is retained.

Details: Minus values represent panning to the left, and positive values represent panning to the right. "0" positions the sound of the selected voice in the center of the stereo sound field.

Refer to: Tutorial, page 24. "THE CONTROLS AND CONNECTORS," page 7.

EFFECT LEVEL

JOB7

```
EF Level   CH 1
#100 100 100 100
```

Summary: Individually sets the effect level for the voice assigned to each multi-play channel.

Settings: 0 ... 100

Procedure: The [←] and [→] cursor keys are used to select the voice/channel for which the effect level is to be set. The [DATA ENTRY] control, [-1/NO] and [+1/YES] keys, or numeric and [ENTER] keys are used to set the effect level.

Details: A setting of "0" produces only the direct sound of the selected voice, while a setting of "100" produces maximum effect. Maximum effect is equivalent to the voice-mode EFFECT BALANCE setting.

Refer to: Tutorial, page 25. "EFFECT BALANCE," page 63. "EFFECT: TYPE/OUTPUT LEVEL" on page 85. "EFFECT: EFFECT PARAMETERS" on page 86.

EFFECT: SOURCE

JOB8

```
EF\Source
      =multi
```

Summary: Determines whether the current multi-play setup will have its own effect settings or the effect parameters of one of the assigned voices will be applied.

Settings: multi, CH1 ... CH16

Procedure: Use the [DATA ENTRY] control, [-1/NO] and [+1/YES] keys, or numeric and [ENTER] keys to select the desired setting.

Details: When "multi" is selected, independent effect parameters can be assigned to the current

multi-play setup via the following effect functions. When a channel number between "CH1" and "CH16" is selected, the effect parameters from the voice assigned to the selected channel number are applied to the current multi-play setup. In the latter case, the following effect functions are not available.

Refer to: "EFFECT: TYPE/OUTPUT LEVEL" on page 85. "EFFECT: EFFECT PARAMETERS" on page 86.

EFFECT: TYPE/OUTPUT LEVEL

JOB 9

● Type

```
EF>Type
1:Rev.Hall 100%
```

Summary: Selects one of 34 digital effects for the current multi-play setup.

Settings and operation are exactly the same as in the voice edit mode: refer to "EFFECT: TYPE/OUTPUT LEVEL" on page 85.

● Output Level

```
EF\Output Level
1:Rev.Hall 100%
```

Summary: Sets the level of the selected multi effect in relation to the direct (no effect) sound.

Settings and operation are exactly the same as in the voice edit mode: refer to "EFFECT: TYPE/OUTPUT LEVEL" on page 85.

EFFECT: EFFECT PARAMETERS

JOB 10

```
EF\Time      :sec
1.Z thru    14
```

Summary: Accesses the individual programmable parameters for the selected multi effect.

Settings and operation are exactly the same as in the voice edit mode: refer to "EFFECT: EFFECT PARAMETERS" on page 86.

MULTI NAME

JOB 11

```

MULTI Name
"POP"

```

Summary: Assigns a name of up to 10 characters to the current multi-play setup.

Settings: The following characters are available for use in multi names:

```

[Space]!"#$%&'()*+,-./0123456789:;<=>?@
ABCDEFGHIJKLMNPOQRSTUVWXYZ[ ]^_`
abcdefghijklmnopqrstuvwxyz( )!+

```

Procedure: Use the [◀] and [▶] cursor keys to place the underline cursor under the character to be changed. Use the [DATA ENTRY] control or [+1/YES] and [-1/NO] keys to select the desired character. Continue until the entire voice name has been programmed.

Details: It's a good idea to give your multi-play setups names that make them easily identifiable. If you've created a new multi that is set up for use with a song titled "The Way Things Are," for example, you could call it something like "TheWay.MUL".

Refer to: Tutorial, page 25.

MULTI RECALL

JOB 12

```

MULTI Edit
Recall

```

Summary: Recalls the last multi-play setup edited from the SY55 edit buffer.

Settings: None

Procedure: After selecting the "MULTI Edit Recall" display, press the [ENTER] key. "Sure?" will appear on the upper line of the display. Press the [+1/YES] to initialize or [-1/NO] to cancel the initialize operation.

"Completed!" will appear briefly when the recall operation is finished.

Details: Even if you've exited the multi edit mode and called a different multi-play setup, this function will recall the last multi-play setup edited with all parameters as they were at the time the multi edit mode was exited.

Please note, however, that a compare operation overwrites the recall buffer with the contents of the edit buffer at that time. A recall operation following a compare operation will therefore recall the contents of the edit buffer at the time of the compare operation.

Refer to: Tutorial, page 25.

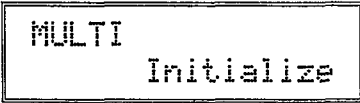

Summary: Initializes all parameters of the current multi-timbral setup.

Settings: None.

Procedure: After selecting the "MULTI Initialize" display, press the [ENTER] key. "Sure?" will appear on the upper line of the display. Press the [+1/YES] to initialize or [-1/NO] to cancel the initialize operation.

"Completed!" will appear briefly when the initialization is finished.

Details: When Multi Initialize is executed, the multi parameters are initialized to the following values:

The multi initialize function is useful if you want to begin programming a multi-timbral setup "from scratch."

Jobs	Initialized Values		
Voice selection	P01		
Volume	127		
Note shift	+0		
Tune	+0		
Reserved note	0		
Panning	+0		
Effect: level	0		
Effect: source	multi		
Effect: type/output level	Type 1	Output level 100%	
Effect: effect parameters	Time 2.6 sec	LPF 8.0 KHz	Delay 29 ms
Multi name	INIT MULTI		

SEQUENCER MODE

Contents

GENERAL OPERATION	117
Selecting the Sequencer Play, Record, & Edit Mode Jobs	117
JOBS & PARAMETERS	118
SEQUENCER PLAY & RECORD MODES	
MEASURE, TEMPO & TIME SIGNATURE	118
CLICK SELECT	118
SYNC SELECT	119
TRACK TRANSMIT CHANNEL	119
RECORD CHANNEL	120
RECORD FILTER	120
MIDI CONTROL	121
SEQUENCER EDIT MODE	
MIXDOWN	122
QUANTIZE	122
DELETE	123
INSERT	124
COPY	124
ERASE	125
REMOVE EVENT	126
SONG NAME	127
SONG PROGRAM	127
SONG CLEAR	128

GENERAL OPERATION

Selecting the Sequencer Play, Record, & Edit Mode Jobs

All basic sequencer record and playback operations have been described in detail in "RECORDING & PLAYBACK WITH THE SEQUENCER" in the tutorial section of this manual.

The play and record mode jobs listed in the following pages can be accessed from either the sequencer play or record standby modes by using the standard page access or job number entry methods (see page 52).

The sequencer edit mode is accessed by pressing the [EDIT/ COMPARE] key while in the sequencer play mode, and the sequencer edit mode jobs are selected by using the standard page access or job number entry methods. The sequencer edit mode can be exited at any time by pressing the [EXIT] key.

JOBS & PARAMETERS

SEQUENCER PLAY & RECORD MODES

MEASURE, TEMPO & TIME SIGNATURE

JOB 1

• Play Mode Display

```
SONG 1:NewSong  
M001 T120 4/4
```

• Record Mode Display

```
over TR1  
M001 T120 4/4
```

Summary: Allows selection of the measure from which to begin playback or recording, the tempo at which to play or record, and the time signature of a new track to be recorded.

Settings:

Measure: M001 — M999 (max. is last measure in sequence).

Tempo: T030 — T240 (beats per minute).

Time Signature: 1/4 ... 4/4, 1/8 ... 8/8, 1/16 ... 16/16.

Procedure: Use the [◀] and [▶] cursor keys to move the underline cursor to the desired parameter, then use the [DATA ENTRY] control, the [-/NO] and [+1/YES] keys, or the numeric and [ENTER] keys to set as required.

The time signature parameter can only be accessed in the record mode when nothing has yet been recorded to the currently selected song. Further, the time signature numerator and denominator can be selected separately using the [◀] and [▶] keys.

Details: Although the upper line of this display is different in the play and record modes (song number in play mode, record mode and record track in record mode — see "RECORDING & PLAYBACK WITH THE SEQUENCER" in the tutorial section), the parameters on the lower line are the same in both modes.

Refer to: Tutorial, page 28.

CLICK SELECT

JOB 2

```
SONG 1:NewSong  
Click= rec
```

Summary: Determines when the sequencer's metronome click sounds.

Settings: off, rec, play/rec, always

Procedure: Use the [DATA ENTRY] control or [-/NO] and [+1/YES] keys to select the desired click mode.

Details: The "off" setting means that the metronome never sounds. This setting is useful for recording free-tempo passages. The "rec" setting

causes the metronome to sound only during recording, the "rec/play" setting causes the metronome to sound during both recording and playback, and the "always" setting causes the metronome to sound all the time — even when the sequencer is not running. The last setting (always) allows the metronome to be used for keyboard practice.

The volume of the click metronome sound can be adjusted via the rear-panel [CLICK VOLUME] control.

Refer to: Tutorial, page 29, "REAR PANEL," page 7.

SYNC SELECT

JOB 3

```
SONG 1:NewSong
Sync=internal
```

Summary: Determines whether the SY55 sequencer timing is synchronized by its own internal clock or an external MIDI clock.

Settings: internal, MIDI

Procedure: Use the [DATA ENTRY] control or [-/NO] and [+1/YES] keys to select the desired sync mode.

Details: "internal" is the normal setting when the SY55 is being used alone. If you are using the SY55 with an external sequencer, MIDI computer, or other MIDI device, and you want the

SY55 to be synchronized to the external device, set this function to MIDI. In the latter case, the external device must be connected to the SY55 MIDI IN connector, and must be transmitting an appropriate MIDI clock signal.

Refer to: Page 27 of separate MIDI DATA FORMAT.

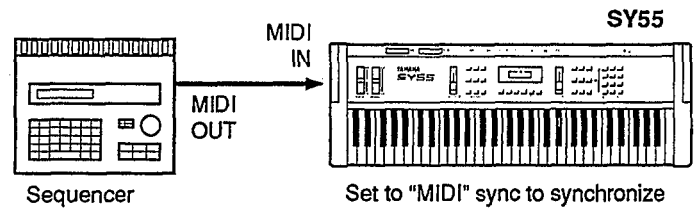

Set to "MIDI" sync to synchronize SY55 sequencer to external MIDI device.

TRACK TRANSMIT CHANNEL

JOB 4

```
SONG 1:NewSong
Tch:TR1= 1
```

Summary: Determines which MIDI channel the data from each sequencer track will be transmitted on.

Settings:
Track: 1 ... 8.
Channel: 1 ... 16

Procedure: Use the [◀] and [▶] cursor keys to select the track parameter (TR1 ... TR8) or MIDI channel parameter (1 ... 16 to the right of the "=" sign). Use the [DATA ENTRY] control, [-/NO] and [+1/YES] keys, or numeric and [ENTER] keys to select the desired track or channel.

Details: The track transmit channel assignments can normally be left at their default settings — i.e. track 1 = channel 1, track 2 = channel 2, etc. This means that there is an easy-to-follow one-to-one correspondence between the sequencer tracks and the receive channels of your multi-play setups.

This function becomes most useful when the SY55 sequencer data is used to play external MIDI tone generators or keyboards in addition to the internal tone generator system. The track transmit channel function allows you to match the SY55 transmission channels to the receive channels of your external tone generator/keyboard setup.

Refer to: Tutorial, page 27.

SEQUENCER MODE

RECORD CHANNEL

JOB 5

```
SONG 1:NewSong  
fr= 99% Rch= kbd
```

Summary: Selects input from the SY55 keyboard, or sets the MIDI receive channel when data is to be recorded from an external MIDI device.

Settings: kbd, 1 ... 16, omni

Procedure: Use the [DATA ENTRY] control, [-1/NO] and [+1/YES] keys, or numeric and [ENTER] keys to select "kbd" or a MIDI channel. When using the numeric keys, "00" = "kbd," and any number higher than 16 selects "omni."

Details: This function must be set to "kbd" if you will be recording from the SY55 keyboard. If you will be recording from an external MIDI controller such as a master keyboard or wind

controller, however, select the appropriate MIDI channel or the "omni" mode for reception on all MIDI channels.

The "fr=***%" ("***" is a number between and 100) display to the left of the lower display line shows the remaining sequencer memory capacity in percent.

RECORD FILTER

JOB 6

```
SONG 1:NewSong  
A.T=off Vel= on
```

Summary: Independently turns recording of velocity and after touch data on or off.

Settings:

A.T (After Touch): on, off
Vel (Velocity): on, off

Procedure: Use the [◀] and [▶] cursor keys to select the A.T or Vel. parameter, and use the [DATA ENTRY] control or [-1/NO] and [+1/YES] keys to turn the selected parameter on or off.

Details: After touch data tends to be quite voluminous, and can use up the sequencer memory capacity quickly. For this reason, the default setting for after touch data recording is "off." turn this parameter "on" only if you specifically want to use an after touch effect.

The default setting for velocity data (initial touch) recording is "on." This is because the amount of velocity data produced is only small compared with after touch data, and the velocity data is essential for reproduction of keyboard dynamics. Velocity data recording can be turned "off" to flatten out the dynamics of a performance, if desired.

MIDI CONTROL

JOB 7

```

SONG 1:NewSong
MIDI Control= on

```

Summary: Turns the sequencer MIDI control functions on or off.

Settings: on, off

Procedure: Use the [DATA ENTRY] control or [-/NO] and [+1/YES] keys to turn MIDI control on or off.

Details: When this parameter is turned "off," the following MIDI functions are de-activated:

1. Transmission and reception of MIDI start, stop and continue messages.
2. MIDI clock transmission.
3. MIDI song position pointer reception (the SY55 does not transmit song pointer messages).

MIDI control can be turned "off" to prevent unwanted interference from external MIDI devices connected to the SY55, and/or to prevent the SY55 sequencer from affecting operation of the external equipment.

Refer to: Page 24 of separate MIDI DATA FORMAT.

SEQUENCER EDIT MODE

MIXDOWN

JOB 1

```
Mixdown
TR1 + TR1 → TR1
```

Summary: Combines the data from two different tracks and copies the result to a third track.

Settings:

Source track 1: 1 ... 8
Source track 2: 1 ... 8
Destination track: 1 ... 8

Procedure: Use the [◀] and [▶] cursor keys to select the first source track (the leftmost parameter, before the "+" sign), the second source track (the center parameter, after the "+" sign), or the destination track (the rightmost parameter, after the "→" sign). Use the [DATA ENTRY] control, [-1/NO] and [+1/YES] keys, or numeric and [ENTER] keys to select the track numbers.

After selecting the desired source and destination tracks, press the [ENTER] key. "Sure?" will appear on the upper line of the display. Press the [+1/YES] to mixdown or [-1/NO] to cancel the operation.

"Executing!" will appear on the display during mixdown, and "Completed!" will appear briefly when the mixdown is finished.

Details: The mixdown function is most useful when you want to record more than 8 individual parts. Successfully recorded parts can be combined using this function, thus opening up more tracks for further recording. The data in the source tracks is not erased during a mixdown operation.

Please note that if both source tracks are set to the same track number, the data from that track will simply be copied to the destination track.

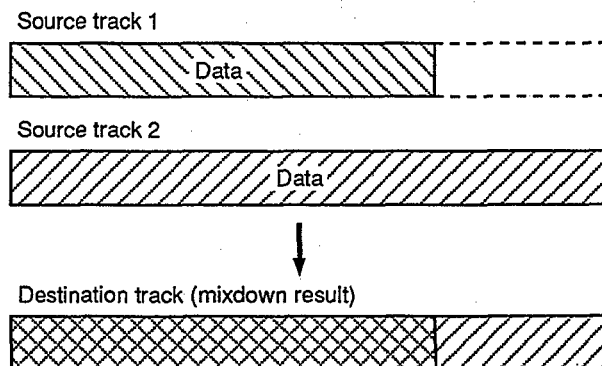

QUANTIZE

JOB 2

```
Quantize
TR1 Size 1/48
```

Summary: Aligns notes in the specified track to the nearest specified beat.

Settings: 1/48, 1/32, 1/24, 1/16, 1/12, 1/8, 1/6, 1/4

Procedure: Use the [◀] and [▶] cursor keys to select the track (leftmost) or quantize value

(rightmost) parameter. Use the [DATA ENTRY] control, [-1/NO] and [+1/YES] keys, or numeric and [ENTER] keys to select the track number or quantize value.

After selecting the desired track and quantize value, press the [ENTER] key. "Sure?" will appear on the upper line of the display. Press the [+1/YES] to quantize or [-1/NO] to cancel the operation.

"Executing!" will appear on the display during quantization, and "Completed!" will appear

briefly when quantization is finished.

Details: Quantization is generally used to tighten up sloppy timing. Use it judiciously, however, because timing that is too perfect can sound cold and mechanical — unless, of course, you're specifically aiming for a cold, mechanical feel. Always use a quantize value that is at least as "short" as the shortest notes in the track to be quantized. If you quantize a track containing 16th notes to 1/8 (8th notes), for example, some of the 16th notes will be aligned with 8th note beats, thus ruining the track.

The various quantize values correspond to note lengths as follows:

• Quantize/note correspondences

QUANTIZE VALUE	BEAT	QUANTIZE VALUE	BEAT
1/4		1/16	
1/6		1/24	
1/8		1/32	
1/12		1/48	

One measure of 8th notes before quantization.



After quantization.



DELETE

JOB 3

Delete All Track
M001 ~ 001

Summary: Deletes the specified measure or range of measures from all tracks.

Settings: Beginning and end measure numbers.

Procedure: Use the [◀] and [▶] cursor keys to select the beginning (leftmost) or end (rightmost) measure parameter. Use the [DATA ENTRY] control, [-1/NO] and [+1/YES] keys, or numeric and [ENTER] keys to select the measure numbers.

After selecting the desired measure numbers, press the [ENTER] key. "Sure?" will appear on the upper line of the display. Press the [+1/YES] to delete the selected measures or [-1/NO] to cancel the operation.

Details: It's important to remember that a delete operation affects all tracks simultaneously, and that measures following the deleted range are moved back to take the place of the deleted measures.

Delete M004—006



Measure 4 through 6 deleted.

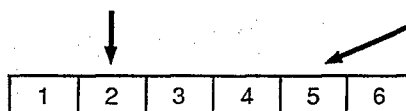
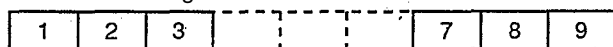

Subsequent measures moved back.

INSERT

JOB 4

```
Insert All Track  
M001~001 → M001
```

Summary: Inserts a specified measure or range of measures from all tracks before any other specified measure.

Settings:

Beginning and end source measure numbers.
Destination measure number.

Procedure: Use the [◀] and [▶] cursor keys to select the beginning source measure (the leftmost parameter), the end source measure (the center parameter), or the destination measure (the rightmost parameter). Use the [DATA ENTRY] control, [-1/NO] and [+1/YES] keys, or numeric and [ENTER] keys to select the measure numbers.

After selecting the desired source and destination measures, press the [ENTER] key. "Sure?"

will appear on the upper line of the display. Press the [+1/YES] to insert or [-1/NO] to cancel the operation.

"Executing!" will appear on the display during insert, and "Completed!" will appear briefly when the insert operation is finished.

Details: Insert affects all tracks simultaneously. The source measure or range of measures is inserted before the specified destination measure.

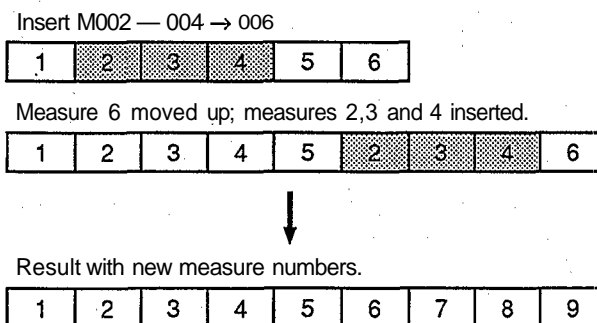

COPY

JOB 5

```
Copy TR1 → TR1  
M001~001 → M001
```

Summary: Copies a specified measure or range of measures from one track to the specified measure in another track.

Settings:

Source and destination track numbers: 1 ... 8
Beginning and end source measure numbers.
Destination measure number.

Procedure: Use the [◀] and [▶] cursor keys to select the source track (leftmost parameter, upper line), destination track (rightmost parameter,

upper line), beginning source measure (leftmost parameter, lower line), end source measure (center parameter, lower line), or destination measure (rightmost parameter, lower line). Use the [DATA ENTRY] control, [-1/NO] and [+1/YES] keys, or numeric and [ENTER] keys to select the track and measure numbers.

After selecting the desired source and destination tracks/measures, press the [ENTER] key. "Sure?" will appear on the upper line of the display. Press the [+1/YES] to copy or [-1/NO] to cancel the operation.

"Executing!" will appear on the display during copy, and "Completed!" will appear briefly when the copy operation is finished.

```
Copy TR1 → TR2
M003~005 → M006
```

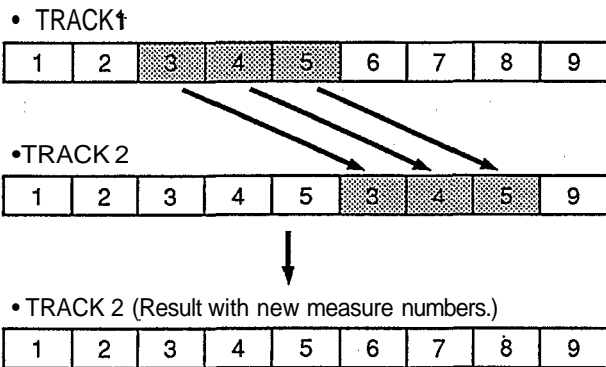

Details: A copy operation overwrites the data from the beginning of the specified destination measure with the data from the source measure(s). Previous data in the overwritten measures is therefore lost.

ERASE JOB 6

```
Erase
TR1 M001 ~ 001
```

Summary: Erases all note and event data from the specified measure or range of measures in the specified track.

Settings:

Track number: 1 ... 8.
Beginning and end measure numbers.

Procedure: Use the [←] and [→] cursor keys to select the track (leftmost parameter), beginning measure (center parameter), or end measure (rightmost parameter). Use the [DATA ENTRY] control, [-1/NO] and [+1/YES] keys, or numeric and [ENTER] keys to select the track and measure numbers.

After selecting the desired track and measures, press the [ENTER] key. "Sure?" will appear on the upper line of the display. Press the [+1/YES] to erase or [-1/NO] to cancel the operation.

"Executing!" will appear on the display during erase, and "Completed!" will appear briefly when the erase operation is finished.

Details: An erase operation leaves the specified measures intact but blank.

```
Erase
TR1 M004 ~ 006
```

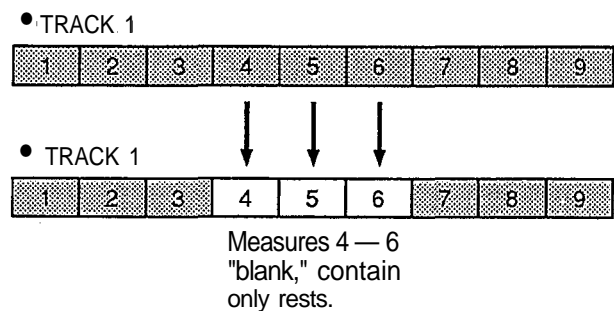

Remove PB
TR1 N001 ~ 001

Summary: Allows pitch bend, after touch, or control change events (data) to be removed from a specified measure or range of measures in a specified track.

Settings:

Event parameter: PB, AT, CT (control change number: 0 ... 120).
Track number: 1 ... 8.
Beginning and end measure numbers.

Procedure: Use the [◀] and [▶] cursor keys to select the event parameter (upper line), track (leftmost parameter, lower line), beginning measure (center parameter, lower line), or end measure (rightmost parameter, lower line). Use the [DATA ENTRY] control, [-1/NO] and [+1/YES] keys to select the event type. The numeric and [ENTER] keys can also be used to select the track and measure numbers.

If "CT" (control change) is selected, a control number parameter will also appear on the upper display line: use the cursor keys to select it and the [DATA ENTRY] control, [-1/NO] and [+1/YES] keys, or numeric and [ENTER] keys to select the control change number to be removed.

After selecting the desired event, track, and measures, press the [ENTER] key. "Sure?" will appear on the upper line of the display. Press the [+1/YES] to remove or [-1/NO] to cancel the operation.

"Executing!" will appear on the display during remove, and "Completed!" will appear briefly when the remove operation is finished.

Details: "PB" stands for Pitch Bend, "AT" stands for After Touch, and "CT" stands for control change. If you choose to remove control change events — modulation wheel, breath controller, volume, etc. — you must also specify the control change number corresponding to the specific even you want to remove. Abbreviations

for common control change events are displayed to the right of the control change numbers to which they are assigned. Unassigned control change numbers are followed by "—."

For your reference, the following is a list of assigned controllers:

Number	Controller
1	MOD (Modulation wheel)
2	BC (Breath controller)
4	FC (Foot controller)
5	POT (Portament time)
6	DE (Data entry control)
7	VOL (Volume)
8	BAL (Balance)
10	PAN (Pan)
11	EXP (Expression)
64	HD1 (Hold 1)
65	POS (Portament switch)
66	SST (Sostenuto)
67	SFT (Soft pedal)
69	HD2 (Hold 2)
91	EFF (Effect switch)
92	TRE (Tremolo)
93	CHO(Chorus)
94	CEL (Celeste)
95	PHA (Phaser)
96	INC (Increment)
97	DEC (Decrement)
98	NRP (Non registered parameter no. LSB)
99	NRP (Non registered parameter no. MSB)
100	RPN (Registered parameter no. LSB)
101	RPN (Registered parameter no. MSB)

Refer to: Page 26 of separate MIDI DATA FORMAT.

SONG NAME **JOB 8**

```
SONG Name
  "NewSong "
```

Procedure: Use the [◀] and [▶] cursor keys to place the underline cursor under the character to be changed. Use the [DATA ENTRY] control or [+1/YES] and [-1/NO] keys to select the desired character. Continue until the entire voice name has been programmed.

Details:

Refer to: Tutorial, page 27.

Summary: Assigns a name of up to 10 characters to the current voice.

Settings: The following characters are available for use in voice names:

```
[Space] ! " # $ % & ' ( ) * + , - . / 0 1 2 3 4 5 6 7 8 9 : ; < = > ? @
A B C D E F G H I J K L M N O P Q R S T U V W X Y Z [ \ ] ^ _ `
a b c d e f g h i j k l m n o p q r s t u v w x y z ( ) * +
```

SONG PROGRAM **JOB 9**

```
SONG Program off
M P01:POP
```

Details: If the SONG Program is turned "on" and an appropriate multi-play setup of voice is selected, a display similar to the following will appear when the corresponding song number is later selected (or the sequencer mode is selected and the corresponding song number is the first to appear).

```
SONG 1: SongName
Load Song Data ?
```

Summary: Creates a program for the currently selected song number that loads a specified multi-play setup or voice from the internal, preset or card bank when the same song is later selected in the sequencer play mode.

Settings:

Mode: on/off.
 Multi (M): I1 ... I16 , P1 ... P16, or C1 ... C16.
 Voice (V): I1 ... I64 , P1 ... P64, or C1 ... C64.

Procedure: Use the [◀] and [▶] cursor keys to select the desired parameter. The mode (on or off) parameter in the upper right-hand corner and the M/V (multi or voice) parameter in the lower left-hand corner of the display can be switched using the [DATA ENTRY] control or [-1/NO] and [+1/YES] keys.

The multi or voice bank can be selected using the [INTERNAL], [PRESET] and [CARD] keys, and the multi or voice number is selected using the [DATA ENTRY] control, the [-1/NO] and [+1/YES] keys, or the numeric and [ENTER] keys.

If, however, the multi-play setup or voice specified in the song program is already selected, there's no need to load the data so the above display will not appear. Press the [+1/YES] key to load the program data and continue, or the [-1/NO] key to continue without loading the data.

SEQUENCER MODE

SONG Clear

Summary: Clears the currently selected song from memory.

Settings: None

Procedure: After selecting the SONG Clear display, press the [ENTER] key. "Sure?" will appear on the upper line of the display. Press the [+1/YES] to clear or [-1/NO] to cancel the operation.

"Executing!" will appear on the display during clear, and "Completed!" will appear briefly when the clear operation is finished.

Details: In addition to clearing all sequencer data for the current song, the clear function initializes the following parameters:

Functions	Initialized Values
Song name	New Song
Tempo	120
Time signature	4/4

UTILITY MODE

Contents

GENERAL OPERATION	131
Selecting the UtilityMode & Jobs	131
JOBS & PARAMETERS	132
MASTER TUNE	132
TRANSPOSE	132
VELOCITY CURVE	133
EFFECT	133
MIDI RECEIVE CHANNEL	134
KEYBOARD TRANSMIT CHANNEL	134
LOCAL CONTROL ON/OFF	135
MIDI PROGRAM CHANGE	135
MIDI DEVICE NUMBER	136
BULK IN PROTECT	136
MIDI BULK OUT	137
MEMORY CARD BANK SELECT	138
MEMORY CARD FORMAT	138
SAVE SYN DATA	139
LOAD SYN DATA	139
SAVE ALL SEQ DATA	140
LOAD ALL SEQ DATA	140
CARD SONG DIRECTORY	141
SAVE 1 SONG	141
LOAD 1 SONG	142
DELETE 1 CARD SONG	142

GENERAL OPERATION

Selecting the UtilityMode & Jobs

The utility mode and its various jobs are selected in exactly the same way as in the voice, drum, multi-play and sequencer edit modes. Press [UTILITY] to enter the utility mode; use the page access or direct job number entry procedure to select jobs; use the [◀] and [▶] cursor keys to select parameters within a job display; and use the [DATA ENTRY]

control, [-1/NO] and [+1/YES] keys, or numeric and [ENTER] keys to change values or settings. When using the page access method, the MIDI and CARD jobs are contained in subsets accessed by pressing the [ENTER] key at the appropriate screen, and exited by pressing the [EXIT] key.

JOBS & PARAMETERS

MASTER TUNE

JOB 1

```
UT Master Tune
      = +0
```

Summary: Tunes the overall pitch of the SY55 over approximately a 150-cent range.

Settings: -64 ... +63

Procedure: The [DATA ENTRY] control, [-1/NO] and [+1/YES] keys, or numeric and [ENTER] keys are used to set the desired degree of tuning.

Details: Each tuning increment corresponds to a 75/64-cent change in pitch. The entire tuning range is therefore $75/64 \times 127$ (i.e. 64 + 63 increments) — almost 150 cents. Since 100 cents equals one semitone, the tuning range is approximately one and a half semitones. A setting of "+0" produces normal pitch.

Refer to: "TUNE," page 97 and 109.

TRANSPOSE

JOB 2

```
UT Transpose
      = +0
```

Summary: Transposes the overall pitch of the SY55 up or down in semitone steps.

Settings: -64 ... +63.

Procedure: The [DATA ENTRY] control, [-1/NO] and [+1/YES] keys, or numeric and [ENTER] keys are used to set the desired degree of transposition.

Details: A setting of "-12," for example, transposes down by one octave; a setting of "+4" transposes up by a major third.

Refer to: "NOTE SHIFT," pages 59, 97 and 109.

VELOCITY CURVE

JOB 3

```

UT Vel.Curve
=1(normal )

```

Summary: Selects one of eight different velocity curves.

Settings: 1 (normal), 2 (soft-1), 3 (soft-2), 4 (easy), 5 (wide), 6 (hard), 7 (cross-1), 8 (cross-2)

Procedure: The [DATA ENTRY] control, [-1/NO] and [+1/YES] keys, or numeric and [ENTER] keys are used to select the desired velocity curve.

Details: The velocity curves determine how the SY55 responds to different velocity values (i.e. keyboard dynamics). Different keyboards and controllers have different velocity sensitivity, and different players have individual preferences. This function lets you select the velocity curve that best suits your keyboard/controller and playing style. Try each one out to find the one you like best.

EFFECT

JOB 4

```

UT Effect
= 00

```

Summary: Turns the SY55 effect processor on or off.

Settings: off, on

Procedure: Use the [DATA ENTRY] control, [-1/NO] and [+1/YES] keys, or numeric and [ENTER] keys to turn the effect processor off or on.

Details: This function completely turns the system effect processor off or on, so when it is turned off, no effects are applied to any voices or multi-play setups.

Refer to: "EFFECT: TYPE/OUTPUT LEVEL" on page 85. "EFFECT: EFFECT PARAMETERS" on page 86.

MIDI RECEIVE CHANNEL

JOB 5

```
UT MIDI\Receive
Ch=omni Note=all
```

Summary: Sets the SY55 MIDI receive channel to any channel between 1 and 16, or the "omni" mode for reception on all channels.

Settings:

Ch: 0 ... 16, omni
Note: all, odd, even

Procedure: Use the [\leftarrow] and [\rightarrow] keys to select the "Ch" or "Note" parameter, then the [DATA ENTRY] control or [-1/NO] and [+1/YES] keys to set as required. The numeric and [ENTRY] keys can also be used to select the channel number.

Details: Make sure that the SY55 MIDI receive channel is either set to the channel that your keyboard/controller is transmitting on, or the omni mode.

The "Notes = all" setting means that the SY55 will play all notes received. If the "odd" or "even" setting is chosen, the SY55 will play only odd or even-numbered notes (based on their MIDI note numbers) received from an external MIDI controller or sequencer. This allows two SY55's to be used — one set to "odd" and one to "even" — to achieve 32-note polyphony.

Refer to: "ERROR MESSAGES," page 144.

KEYBOARD TRANSMIT CHANNEL

JOB 6

```
UT MIDI\KbdTch
= 1
```

Summary: Sets the MIDI transmit channel for the SY55.

Settings: 1 ... 16.

Procedure: Use the [DATA ENTRY] control, the [-1/NO] and [+1/YES] keys, or the numeric and [ENTER] keys to select the desired MIDI transmit channel number.

Details: The MIDI transmit channel job is used primarily to match the transmit channel of the SY55 with the receive channel of an external MIDI device being driven by the SY55. When a multi-

play setup is selected, however, the MIDI transmit channel setting also determines which of the setup's voices is played via the SY55 keyboard.

Refer to: Tutorial, page 20.

LOCAL CONTROL ON/OFF

JOB 7

```

UT MIDI\Local
      = on
  
```

Summary: Determines whether the SY55 keyboard controls the internal tone generator system or not.

Settings: on, off.

Procedure: Use the [DATA ENTRY] control or [-1/NO] and [+1/YES] keys to turn local control on or off.

Details: Normally, local control will be turned "on" so that the SY55 keyboard plays its own internal tone generator system. If you want to control an

external MIDI tone generator or other device from the SY55 keyboard without playing the internal tone generator, turn local control "off." One possibility is to drive the SY55 tone generator system from the internal sequencer while independently playing a separate external tone generator from the SY55 keyboard.

Local control is automatically turned ON whenever the power is turned ON.

MIDI PROGRAM CHANGE

JOB 8

```

UT MIDI\Program
      =direct
  
```

Summary: Determines whether the SY55 will respond to MIDI program change messages for remote voice/multi selection.

Settings: off, normal, direct

Procedure: The [DATA ENTRY] control or [+1/YES] and [-1/NO] keys are used to select the desired MIDI program change reception mode.

Details: The "off" setting turns MIDI program change reception off, so operating the voice selectors on your keyboard/controller will not cause the corresponding SY55 voice or multi-play setup to be selected.

In the "normal" mode, program change numbers 0 through 63 select SY55 voices 1 through 64, and program change numbers 64 through 79 select multi-play setups 1 through 16.

The "direct" mode allows, in addition to the voice and multi-play selection of the "normal" mode, selection of the various SY55 modes by reception of program change numbers 119 through 127.

Refer to: "ERROR MESSAGES," page 144. Page 3 of separate MIDI DATA FORMAT.

MIDI DEVICE NUMBER

JOB 9

```
UT MIDI\Device#  
=all
```

Summary: Sets the SY55 MIDI device number — i.e. the MIDI channel on which all system exclusive data will be received and transmitted.

Settings: off, 1 ... 16, all

Procedure: The [DATA ENTRY] control, [-1/NO] and [+1/YES] keys, or numeric and [ENTER] keys are used to select the desired device number or turn system exclusive reception/transmission off.

Details: The device number is important for transfer of voice data and other system exclusive data between the SY55 and other YAMAHA MIDI

devices — e.g. another SY55, the SY55 Digital Synthesizer, a YAMAHA MIDI sequence recorder such as the QX3, etc. Bulk voice data, for example, is transmitted and received on the channel specified by the device number (see the BULK IN PROTECT and BULK OUT functions, described below). Make sure that the SY55 device number is matched to that of other devices in your system with which such data transfers will take place.

Refer to: "ERROR MESSAGES," page 144. "MIDI BULK OUT," page 137.

BULK IN PROTECT

JOB 10

```
UT MIDI\Bulk In  
Protect= on
```

Summary: Enables or disables bulk data reception.

Settings: off, on

Procedure: The [DATA ENTRY] control or [+1/YES] and [-1/NO] keys are used to select off or on.

Details: When this function is set to "off," the SY55 will automatically receive a bulk dump of voice, multi-play or system data from an external device connected to its MIDI IN terminal when the appropriate bulk dump data is received (assum-

ing that the SY55 and transmitting device are both set to the same device number).

Turn bulk in protect "on" to disable bulk dump reception (this prevents accidental disruption of the SY55 during use).

Bulk in protect automatically turned ON whenever the power is turned ON.

Refer to: "MIDI BULK OUT," page 137. "ERROR MESSAGES," page 144. "MIDI DEVICE NUMBER," above.

MIDI BULK OUT

JOB 11

```

UT MIDI\Bulk Out
  syn voice P01

```

Summary: Initiates bulk transmission of multi-play, voice, system sequencer or all data.

Settings:

syn: multi I01 ... I16, P01 ... P16, int, pre.
 voice I01 ... I64, P01 ... P64, int, pre.
 V & M int, pre.
 system.
 all.
 seq: song 1 ... 8.
 setup.
 all.
 all:

Procedure: Use the [◀] and [▶] cursor keys to select the leftmost parameter and used the [DATA ENTRY] control or [+1/YES] and [-1/NO] keys to select synthesizer data ("syn"), sequencer data ("seq") or all data ("all"). Then move the cursor one step to the right and select the data type (multi, voice, V & M, system, or all when "syn" is selected; song, setup or all when "seq" is selected). Move the cursor one more step to the right and select the desired voice, multi or song number where applicable.

When the desired data has been selected, press [ENTER]. "Sure?" will appear at the top of the screen. Press [+1/YES] to actually begin transmission of the selected data. "Now Transmitting" will appear during transmission, and "Completed!" will appear briefly when the transmission has finished.

Details:

- **syn:** The "multi" setting allows transmission of individual or complete banks of multi-play setup data. Select I01 through I16 for individual transmission of the corresponding INTERNAL multi-play setup, or P01 through P16 for individual transmission of the corresponding PRESET multi-play setup. The "P" and "I" banks are switched using the [PRESET] or [INTERNAL] key. The "int" or "pre" setting that appears after the highest memory number causes transmission of the entire INTERNAL (int) or PRESET (pre) multi-play bank.

The "voice" setting allows transmission of individual or complete banks of voice data. Select I01 through I64 for individual transmission of the corresponding INTERNAL voice, or P01 through P64 for individual transmission of the corresponding PRESET voice. The "P" and "I" banks are switched using the [PRESET] or [INTERNAL] key. The "int" or "pre" setting that appears after the highest memory number causes transmission of the entire INTERNAL (int) or PRESET (pre) voice bank.

The "V & M" setting allows transmission of all voices and multi-play setups in the internal or preset bank. Select "int" or "pre" using the [-1/NO] and [+1/YES] keys.

The "system" setting transmits all system setup data — e.g. current mode, utility master tune, utility transpose, utility effect and other settings.

The "all" setting transmits all internal multi, voice and system data.

- **seq:** The "song" setting allows transmission of sequencer song 1 through 8. The "setup" setting transmits all sequencer setup data, and the "all" setting transmits all song and setup data.
- **all:** The "all" setting transmits all of the above data.

The BULK OUT job will not work if the SY55 MIDI device number is set to "off."

MEMORY CARD BANK SELECT

JOB 12

```
UT Card\Bank
=1(unfmt)
```

Summary: Selects bank 1 or bank 2 of a Yamaha MCD64 type memory prior to formatting or load/save operations.

Settings: 1,2

Procedure: Use the [DATA ENTRY] control or [+1/YES] and [-1/NO] keys to select the desired bank.

Details: The format of the selected bank is shown in parentheses following the bank number:

(55 SYN) = TG55/SY55 synthesizer format.

(55 SEQ) = SY55 sequencer format.

(SY77) = SY77 Digital Synthesizer format.

(V50) = V50 format.

(RX8) = RX8 Digital Rhythm Programmer format.

(YS S/V) = EOS synthesizer format.

(YS S/V) = EOS sequencer format.

(Unfmt) = Unformatted.

(NoBank) = Bank unavailable (appears if bank 2 of single-bank MCD32 card is selected).

The only formats useable by the SY55 are "55 SYN" and "SY SEQ". Cards with a different format will have to be reformatted using the MEMORY CARD FORMAT job described below before they can be used with the SY55.

MEMORY CARD FORMAT

JOB 13

```
UT Card\Format
(unfmt) → syn
```

Summary: Formats MCD64 or MCD32 Memory Cards to the "55 SYN" or "55 SEQ" format required by the SY55.

Settings: syn, seq

Procedure: After selecting the card bank to be formatted using the MEMORY CARD BANK SELECT job described above, select this job and use the [DATA ENTRY] control or [+1/YES] and [-1/NO] keys to select the "syn" (voice data) or "seq" (sequencer data) format. Press [ENTER]. "Sure?" will appear at the top of the screen.

Press [+1/YES] to actually begin formatting. "Executing!" will appear during formatting, and "Completed!" will appear briefly when the format operation has finished.

Details: Formatting can only be carried out if the memory card WRITE PROTECT switch is turned OFF (refer to your MCD64 or MCD32

Memory Card instructions for details. If you attempt to format a memory card with the WRITE PROTECT switch set to ON, the following error display will appear:

```
ERROR! Hit "EXIT"
Data Card Prot.
```

If this happens, press the [EXIT] key to return to the previous display.

The current format of the selected card bank is shown in the parentheses to the left of the screen. See the format abbreviations in the "Details" section of the MEMORY CARD BANK SELECT job, described above.

SAVE SYN DATA

JOB 14

```

UT Card\Save
  SYN U & M

```

Summary: Saves voice and multi-play data, system data, or both (all) to a memory card.

Settings: V & M, system, all.

Procedure: This function can only be selected if a memory card formatted for voice data (55 SYN) is inserted in the DATA card slot.

After selecting the card bank to which the data is to be saved using the MEMORY CARD BANK SELECT job described above, select this job and choose the type of data to be saved ("V & M", "system" or "all") using the [-1/NO] and [+1/YES] keys. Then press [ENTER]. "Sure?" will appear at the top of the screen. Press [+1/YES] to actually begin loading. "Executing!" will appear during loading, and "Completed!" will appear briefly when the load operation has finished.

Details: Exercise caution when saving data to a memory card — the previous card data will be erased and completely replaced by the saved data.

The "V & M" setting saves all voice and

multi-play data, the "system" setting saves only the system setup data (current mode, utility master tune, utility transpose, utility effect and others), and the "all" setting saves all of the above.

A data save operation can only be carried out if the memory card WRITE PROTECT switch is turned OFF (refer to your MCD64 or MCD32 Memory Card instructions for details). If you attempt to save with the WRITE PROTECT switch set to ON, the following error display will appear:

```

ERROR! Hit"EXIT"
Data Card Prot.

```

If this happens, press the [EXIT] key to return to the previous display.

LOAD SYN DATA

JOB 15

```

UT Card\Load
  SYN U & M

```

Summary: Loads voice and multi-play data, system data, or both (all) from a memory card into the SY55 internal memory.

Settings: V & M, system, all.

Procedure: This function can only be selected if a memory card formatted for voice data (55 SYN) is inserted in the DATA card slot.

After selecting the card bank containing the data to be loaded using the MEMORY CARD BANK SELECT job described above, select this job and choose the type of data to be loaded ("V & M", "system" or "all") using the [-1/NO] and

[+1/YES] keys. Then press [ENTER]. "Sure?" will appear at the top of the screen. Press [+1/YES] to actually begin loading. "Executing!" will appear during loading, and "Completed!" will appear briefly when the load operation has finished.

Details: Exercise caution when loading data from a memory card — the corresponding internal SY55 data will be erased and completely replaced by the loaded data.

The "V & M" setting loads all voice and multi-play data, the "system" setting loads only the system setup data (current mode, utility master tune, utility transpose, utility effect and others), and the "all" setting loads all of the above.

SAVE ALL SEQ DATA

JOB 16

```
UT Card\Save
      SEQ    all
```

Summary: Saves all sequencer data to a memory card.

Settings: None.

Procedure: This function can only be selected if a memory card formatted for sequencer data (55 SEQ) is inserted in the DATA card slot.

After selecting the card bank to which the data is to be saved using the MEMORY CARD BANK SELECT job described above, press [ENTER]. "Sure?" will appear at the top of the screen. Press [+1/YES] to actually begin loading. "Executing!" will appear during loading, and "Completed!" will appear briefly when the load operation has finished.

Details: Exercise caution when saving data to a memory card — the previous card data will be erased and completely replaced by the saved data.

A data save operation can only be carried out if the memory card WRITE PROTECT switch is turned OFF (refer to your MCD64 or MCD32 Memory Card instructions for details). If you attempt to save with the WRITE PROTECT switch set to ON, the following error display will appear:

```
ERROR! Hit "EXIT"
Data Card Prot.
```

If this happens, press the [EXIT] key to return to the previous display.

LOAD ALL SEQ DATA

JOB 17

```
UT Card\Load
      SEQ    all
```

Summary: Loads all sequencer data from a memory card into the SY55 sequencer.

Settings: None.

Procedure: This function can only be selected if a memory card formatted for sequencer data (55 SEQ) or (YS SEQ) is inserted in the DATA card slot. After selecting the card bank containing the data to be loaded using the MEMORY CARD BANK SELECT job described above, select this job and press [ENTER]. "Sure?" will appear at

the top of the screen. Press [+1/YES] to actually begin loading. "Executing!" will appear during loading, and "Completed!" will appear briefly when the load operation has finished.

Details: Exercise caution when loading data from a memory card — the corresponding internal SY55 data will be erased and completely replaced by the loaded data.

CARD SONG DIRECTORY

JOB 18

```
UT Card\SongsDir.
  C1:NewSongs
```

Summary: Displays the titles (song names) of sequencer songs stored on a memory card.

Settings: Song 1 ... 8.

Procedure: This function can only be selected if a memory card formatted for sequencer data (55 SEQ) is inserted in the DATA card slot.

After selecting the card bank containing the songs you want to browse through using the MEMORY CARD BANK SELECT job described above, select this job. Use the [DATA

ENTRY] control, the [-1/NO] and [+1/YES] keys, or the numeric and [ENTER] keys to select the desired song number. The corresponding song name will be shown to the right of the song number on the display.

Details: This job is particularly handy if you have several memory cards and you don't remember which one contains a specific song you're looking for.

SAVE 1 SONG

JOB 19

```
UT Card\SongsSave
  I1+C1:NewSongs
```

Summary: Saves a single sequencer song to a memory card.

Settings:

Internal song number: 1 ... 8.

Card song number: 1 ... 8.

Procedure: This function can only be selected if a memory card formatted for sequencer data (55 SEQ) is inserted in the DATA card slot.

After selecting the card bank to which the data is to be saved using the MEMORY CARD BANK SELECT job described above, select this job and use the [DATA ENTRY] control, the [-1/NO] and [+1/YES] keys, or the numeric and [ENTER] keys to select the internal song number you want to save to the card. Then press the [↵] to move the cursor to the card song number parameter, and select the card song number to which you want to save the song. When you're ready to save, press [ENTER]. "Sure?" will appear at the top of the screen. Press [+1/YES] to actually begin saving. "Executing!" will appear

during the save operation, and "Completed!" will appear briefly when the operation is finished.

Details: Exercise caution when saving data to a memory card — the previous card data will be erased and completely replaced by the saved data.

A data save operation can only be carried out if the memory card WRITE PROTECT switch is turned OFF (refer to your MCD64 or MCD32 Memory Card instructions for details). If you attempt to save with the WRITE PROTECT switch set to ON, the following error display will appear:

```
ERROR! Hit"EXIT"
Data Card Prot.
```

If this happens, press the [EXIT] key to return to the previous display.

LOAD 1 SONG

JOB 20

```
UT Card\SongLoad
C1+I1:NewSong
```

Summary: Loads a single sequencer song from a memory card into the SY55 sequencer.

Settings:

Card song number: 1... 8.

Internal song number: 1 ... 8.

Procedure: This function can only be selected if a memory card formatted for sequencer data (55 SEQ) is inserted in the DATA card slot.

After selecting the card bank from which the data is to be loaded using the MEMORY CARD BANK SELECT job described above, select this job and use the [DATA ENTRY] control, the [-1/NO] and [+1/YES] keys, or the numeric and [ENTER] keys to select the card song number you want to load. Then press the [↵] to move the

cursor to the internal song number parameter, and select the internal song number to which you want to load the song. When you're ready to load, press [ENTER]. "Sure?" will appear at the top of the screen. Press [+1/YES] to actually begin loading. "Executing!" will appear during the load operation, and "Completed!" will appear briefly when the operation is finished.

Details: Exercise caution when loading data from a memory card — the corresponding internal SY55 data will be erased and completely replaced by the loaded data.

DELETE 1 CARD SONG

JOB 21

```
UT Card\SongDel.
C1:NewSong
```

Summary: Deletes a single sequencer song from a memory card.

Settings: Song number: 1... 8.

Procedure: This function can only be selected if a memory card formatted for sequencer data (55 SEQ) is inserted in the DATA card slot.

After selecting the card bank from which the data is to be deleted using the MEMORY CARD BANK SELECT job described above, select this job and use the [DATA ENTRY] control, the [-1/NO] and [+1/YES] keys, or the numeric and [ENTER] keys to select the card song number you want to delete. When you're ready to delete, press [ENTER]. "Sure?" will appear at the top of

the screen. Press [+1/YES] to actually delete the selected song. "Executing!" will appear during the delete operation, and "Completed!" will appear briefly when the operation is finished.

Details: Obviously, you should make quite sure that the song you have selected is the one you really want to delete before executing the delete operation.

ERROR MESSAGES

Things do go wrong from time to time, and people do make mistakes. When an error occurs, the SY55 will usually display a message that describes the type of error so you can easily take steps to rectify the problem. The following are quick summaries of the SY55 error displays.

MIDI Error Messages

<pre>ERROR! Hit"EXIT" MIDI Buffer Full</pre>	MIDI receive buffer overflow. Too much MIDI data being received too quickly.
<pre>ERROR! Hit"EXIT" MIDI Data</pre>	Unrecognizable MIDI data.
<pre>ERROR! Hit"EXIT" MIDI Check Sum</pre>	A checksum error occurred during MIDI data reception.
<pre>ERROR! Hit"EXIT" MIDI Device# off</pre>	Attempt to transmit bulk out or receive bulk data while device number is set to "off."
<pre>ERROR! Hit"EXIT" MIDI Bulk Prot.</pre>	Bulk data was received but ignored because bulk protect function is "on."
<pre>***** Bulk Canceled</pre>	Bulk data reception was cancelled before completion. The upper row of asterisks is the previous display. Any key operation cancels this display.

Memory Card Error Messages

<pre>ERROR! Hit"EXIT" No Data Card</pre>	Attempt to save or load while memory card not inserted in DATA card slot.
<pre>ERROR! Hit"EXIT" Data Card Prot.</pre>	Attempt to save to or format memory card with WRITE PROTECT switch set to ON position.
<pre>ERROR! Hit"EXIT" Data Card Format</pre>	Attempt to save to or load from unformatted memory card or card with wrong format.

```
ERROR! Hit"EXIT"  
Verify Failed
```

Failure to verify data after save or load operation.

```
ERROR! Hit"EXIT"  
Data Card Bat.Lo
```

Memory card battery voltage low. Replace battery as described in Memory Card instruction sheet.

```
ERROR! Hit"EXIT"  
Data Card Bat.NG
```

Memory card voltage malfunction. Have the unit checked by qualified YAMAHA service personnel.

Sequencer Error Messages

```
ERROR! Hit"EXIT"  
SEQ Buffer Full
```

Excessive data from an external device or a complex internal SONG is causing the sequencer buffer to overflow. The amount of data being received from the external device must be reduced, or the SONG data must be simplified.

```
ERROR! Hit"EXIT"  
SEQ Memory Full
```

Recording or editing has caused the sequencer memory to become full. Further recording or editing may be possible if unwanted tracks or song data are erased.

```
ERROR! Hit"EXIT"  
SEQ Data Empty
```

This display will appear if you attempt to edit or perform a bulk dump of a track that contains no data.

```
ERROR! Hit"EXIT"  
Now SEQ Running
```

- a) An external device has sent bulk data to the SY55 while the sequencer is running. Bulk data cannot be received during sequencer operation, so any received data will be ignored.
- b) You have attempted to operate a utility function while the sequencer is running. The sequencer must be stopped before utility functions can be operated.

```
ERROR! Hit"EXIT"  
Song Data Exist
```

Bulk data reception to a song number that already contains data has been attempted. Bulk song data can only be received to an empty song (either erase the existing song data or chose an empty song number).

```
ERROR! Hit"EXIT"  
Song Cleared
```

Erroneous song data was detected at power-on, and the song has been cleared, This could indicate a battery problem. Have the battery checked by qualified YAMAHA service personnel.

Miscellaneous Error Messages

<pre>ERROR! Hit"EXIT" Internal Bat.Lo</pre>	Internal battery voltage low. Have battery replaced by qualified YAMAHA service personnel.
<pre>ERROR! Hit"EXIT" Internal Bat.NG</pre>	Internal voltage malfunction. Have the unit checked by qualified YAMAHA service personnel.
<pre>ERROR! Hit"EXIT" ID Mismatch</pre>	Voice With mismatched wave card ID exists in multi-play setup.
<pre>ERROR! Hit"EXIT" No Wave Card</pre>	Wave card not inserted in WAVE slot.
<pre>ERROR! Hit"EXIT" Wrong Wave Card</pre>	Voice ID and wave card ID do not match.
<pre>ERROR! Hit"EXIT" Voice Type</pre>	Voice number and voice type do not match.
<pre>ERROR! Hit"EXIT" Illegal Data</pre>	Wrong bulk dump byte count or unrecognizable bulk, memory or card data.

SPECIFICATIONS

Keyboard	61 keys, initial and after-touch response.
Tone Generator System	AWM2 (2nd-generation 16-bit Advanced Wave Memory).
Internal Memory	Wave ROM: 74 preset waveforms. Preset ROM: 64 preset voices & 16 preset multi-play setups. Internal RAM: 64 user voices & 16 user multi-play setups.
External Memory	Voice data: MCD64 or MCD32 memory cards — write & read. Wave data: YAMAHA waveform cards — read only.
Sequencer	8 songs/8 tracks per song. Approx. 8,000 notes max.
Display	16-character x 2-line backlit LCD.
Controls	DATA ENTRY, MASTER VOLUME, PITCH, MODULATION, CLICK VOLUME (Sequencer.)
Keys & Switches	POWER, INTERNAL, CARD, PRESET, VOICE, MULTI, SEQ, EDIT/COMPARE, UTILITY, STORE/COPY, -1/NO, +1/YES, PAGE -, PAGE +, ◀, ▶, EXIT, SELECT, ENTER, JOB, numeric 0 — 9, -, ◀◀, ▶▶, RECORD, STOP, RUN.
Output Connectors	PHONES, OUTPUT L/MONO & R, BREATH CONTROLLER, SUSTAIN, FOOT VOLUME.
MIDI Connectors	IN, OUT, THRU.
Power Requirements/ Consumption	US & Canadian models: 120 V / 15 W General model: 220—240 V / 15 W
Dimensions (W x H x D)	911 x 90 x 325 mm (35-7/8" x 3-1/2" x 12-3/4")
Weight	9.7 kg (21 lbs. 6 oz)

* Specifications and appearance subject to change without notice.

INDEX

+1/Yes and -I/No Keys6

A

Alternate Group98

Amplitude Envelope Generator (AEG)
.....64,36,44

Copy Function55

Level64

Level Scale Breakpoint66

Level Scale Offset66

Mode64

Rate64

Rate Scaling66

AWM Wave Selection35

Drum-set Voice96

Voices58

C

Card Memory13

Card Slot

Data6

Waveform6

Click

Select118

Volume Control7

Connections

Basic System11

Controller38

After Touch Pitch Bias81

Amplitude Modulation82

Cutoff Frequency Control83

Cutoff Modulation83

Eg Bias Control84

Pitch Bend Range71

Pitch Modulation82

Random Pitch Range81

Volume Control84

Cursor Keys6

D

Data Entry Control6,53

Detune60

Demo12

Drum-set Voice18

Copy Function in Edit Mode94

Initialized Wave Assignments102

Preset Wave Assignments93, 18

E

Edit/Compare

Key5

Operation54

Copy Function55

Effect

Copy Function56, 95,107

List85

Effect Balance

Drum-set Voice99

Voice63

Effect Level111

Effect, Output Level

Drum-set Voice100

Multi-play112

Voice85

Effect On/Off133

Effect Parameters86

Effect, Type

Drum-set Voice100

Multi-play112

Voice85

Element35

Block Diagram37

Selection in Voice Edit Mode54

Element Initialize79

Enter Key6

Exit Key6

F

Filter37,73

Copy Function55

Cutoff73

Cutoff Envelope Generator75

Cutoff Modulation Depth71

Level Scaling Breakpoint76

Level Scaling Offset77

Mode75

Modulation Sensitivity78

Rate Scaling76

Resonance77

Response Examples37

Type73

Velocity Sensitivity78

Foot Volume Jack7

I	
Initialize	
Drum-set Voice	102
Multi-play	114
Voice	90
Internal Memory	13
Job	
Display	53
Key	6
Number Entry	52
L	
Layered Voice	36
Liquid Crystal Display (LCD)	6
Low Frequency Oscillator (LFO)	
Delay	69
Phase	70
Speed	69
Waveform	69
Low Frequency Oscillator Modulation	
Amplitude	70
Cutoff	71
Pitch	70
M	
Master Tune	132
Master Volume Control	4
Measure Numbers	28,30,31, 118
Memory Card	13
Bank Select	138,16
Delete 1 Song	142
Format	138
Load 1 Song	142
Load All Seq Data	140
Load Synth Data	112
Save 1 Song	141
Save all Seq Data	140
Save Synth Data	112
Song Directory	141
MIDI	
Bulk In Protect	136
Bulk Out	137
Device Number	136
IN, THRU and OUT Connectors	7
Keyboard Transmit Channel	134
Local Control	135
Program Change	135
Receive Channel	135
Modulation Wheel	4
Multi Key	5

Multi-Play	
Mode, Bank and Setup Selection	20
Polyphony and Dynamic Note Allocation	20

N	
Name	
Drum-set Voice	101
Multi-play	113
Voice	89
Note Shift	
Drum-set Voice	97
Multi-play	109
Voice	59
Note Limit	
High	61
Low	60

O	
Oscillator	
Mode	63
Note	64
Tune	64
Output Jacks	7

P	
Page ◀ and Page ▶ Keys	6
Panning	
Drum-set Voice	98
Multi-play	110
Voice	62
Parameter Editing	53
Phones Jack	7
Pitch Wheel	4
Pitch Envelope Generator (PEG)	
Level	71
Rate	71
Sensitivity, Range	72
Sensitivity, Rate Scaling	72
Sensitivity, Velocity	73
Power Switch	7
Preset Memory	13

R	
Recall	
Drum-set Voice	101
Multi-play	113
Voice	89
Reference Section, How to Use	3
Reserved Note	110,24

S

Select Key	6
Sensitivity	
Amplitude Modulation	68
Pitch Modulation	68
Velocity	67
Velocity Rate	67
Sequencer	
Control Keys	4
Copy	124
Delete	123
Erase	125
Insert	124
MIDI Control	121
Mixdown	122
Mode Key	5
Quantize	123
Record Channel	120
Record Filter	120
Recording, Overdub	28
Recording, Punch-in	30
Recording, Realtime	28
Recording, Replace	28
Recording, Step	31
Remove Event	126
Song Clear	128
Song Name	127
Song Program	127
Sync Select	119
Track Transmit Channel	119
Split Keyboard	36
Store/Copy Key	5
Store Functions	
Multi-play Setup	25
Voice	46

T

Time Signature	28, 118
Transpose	132
Tutorial Section, How to Use	3
Tune	
Drum-set Voice	97
Multi-play	109

U

Utility Key	5
--------------------------	---

V

Velocity Curve	133
Velocity Limit	
High	62
Low	61
Voice	
Architecture	35
Edit Mode & Function Selection	52
Key	4
Mode	58
Parameter Chart, Blank	39
Parameter Chart, VeloChorus	40
Preset List	14
Selection	16
Volume	
Drum-set Voice	96
Multi-play	108
Voice	59
Volume Control	11, 17

W

Wave List	35
------------------------	----

IMPORTANT SAFETY AND INSTALLATION INSTRUCTIONS

INFORMATION RELATING TO POSSIBLE PERSONAL INJURY, ELECTRIC SHOCK AND FIRE HAZARD POSSIBILITIES HAS BEEN INCLUDED IN THIS LIST.

WARNING — When using electronic products, basic precautions should always be followed, including the following:

1. Read all Safety and Installation Instructions, Supplemental Marking and Special Message Section data, and any applicable assembly instructions BEFORE using this product.
2. Check unit weight specifications BEFORE you attempt to move this product.
3. Main power supply verification. YAMAHA Digital Musical Instrument products are manufactured specifically for use with the main supply voltage used in the area where they are to be sold. The main supply voltage required by these products is printed on the name plate. For name plate location please refer to the graphic in the Special Message section. If any doubt exists please contact the nearest YAMAHA Digital Musical Instrument retailer.
4. Some YAMAHA Digital Musical Instrument products utilize external power supplies or adapters. Do NOT connect products of this type to any power supply or adapter other than the type described in the owners manual or as marked on the unit.
5. This product may be equipped with a plug having three prongs or a polarized line plug (one blade wider than the other). If you are unable to insert the plug into the outlet, contact an electrician to have the obsolete outlet replaced. Do NOT defeat the safety purpose of the plug. YAMAHA products not having three prong or polarized line plugs incorporate construction methods and designs that do not require line plug polarization.
6. **WARNING** — Do NOT place objects on the power cord or place the unit in a position where anyone could walk on, trip over, or roll anything over cords of any kind. An improper installation of this type can create the possibility of a fire hazard and/or personal injury.
7. Environment: Your YAMAHA Digital Musical Instrument should be installed away from heat sources such as heat registers and/or other products that produce heat.
8. Ventilation: This product should be installed or positioned in a way that its placement or location does not interfere with proper ventilation.
9. YAMAHA Digital Musical Instrument products are frequently incorporated into "Systems" which are assembled on carts, stands or in racks. Utilize only those carts, stands, or racks that have been designed for this purpose and observe all safety precautions supplied with the products. Pay special attention to cautions that relate to proper assembly, heavier units being mounted at the lower levels, load limits, moving instructions, maximum usable height and ventilation.
10. YAMAHA Digital Musical Instrument products, either alone or in combination with amplification, headphones, or speakers, may be capable of producing sound levels that could cause permanent hearing loss. Do NOT operate at high volume levels or at a level that is uncomfortable. If you experience any discomfort, ringing in the ears, or suspect any hearing loss, you should consult an audiologist.
11. Do NOT use this product near water or in wet environments. For example, near a swimming pool, spa, in the rain, or in a wet basement.
12. Care should be taken so that objects do not fall, and liquids are not spilled into the enclosure.
13. YAMAHA Digital Musical Instrument products should be serviced by a qualified service person when:
 - a. The power supply/power adapter cord or plug has been damaged; or
 - b. Objects have fallen, or liquid has been spilled into the products; or
 - c. The unit has been exposed to rain; or
 - d. The product does not operate, exhibits a marked change in performance; or
 - e. The product has been dropped, or the enclosure of the product has been damaged.
14. When not in use, always turn your YAMAHA Digital Musical Instrument equipment "OFF". The power supply cord should be unplugged from the outlet when the equipment is to be left unused for a long period of time.

NOTE: In this case, some units may lose some user programmed data. Factory programmed memories will not be affected.
15. Electromagnetic Interference (RFI). YAMAHA Digital Musical Instruments utilize digital (high frequency pulse) technology that may adversely affect Radio/TV reception. Please read FCC information (inside cover) for additional information.
16. Do NOT attempt to service this product beyond that described in the user maintenance section of the owners manual. All other servicing should be referred to qualified service personnel.

**PLEASE KEEP THIS MANUAL
FOR FUTURE REFERENCE!**

This information on safety is provided to comply with U.S.A. laws, but should be observed by users in all countries.

SPECIAL MESSAGE SECTION

ELECTROMAGNETIC INTERFERENCE (RFI): Your YAMAHA Digital Musical Instrument Product has been type tested and found to comply with all applicable regulations. However, if it is installed in the immediate proximity of other electronic devices, some form of interference may occur. For additional RFI information see the FCC information section located in this manual.

IMPORTANT NOTICE: This product has been tested and approved by independent safety testing laboratories in order that you may be sure that when it is properly installed and used in its normal and customary manner, all foreseeable risks have been eliminated. DO NOT modify this unit or commission others to do so unless specifically authorized by YAMAHA. Product performance and /or safety standards may be diminished. Claims filled under the expressed warranty may be denied if the unit is/has been modified. Implied warranties may also be affected.

SPECIFICATIONS SUBJECT TO CHANGE: The information contained in this manual is believed to be correct at the time of printing. YAMAHA reserves the right to change or modify specifications at any time without notice or obligation to update existing units.

NOTICE: Service charges incurred due to a lack of knowledge relating to how a function or effect works (when the unit is operating as designed), are not covered by the manufacturer's warranty. Please study this manual carefully before requesting service.

NAME PLATE LOCATION: The graphic below indicates the location of the Name Plate on your YAMAHA Digital Musical Instrument. The Model, Serial Number, Power requirements, etc., are indicated on this plate.

You should note the model, serial number and the date of purchase in the spaces provided below and retain this manual as a permanent record of your purchase.

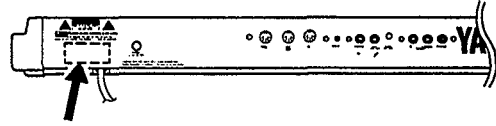

STATIC ELECTRICITY CAUTION: Some YAMAHA Digital Musical Instrument products have modules that plug into the unit to perform various functions. The contents of a plug-in module can be altered/damaged by static electricity discharges. Static electricity build-ups are more likely to occur during cold winter months (or in areas with very dry climates) when the natural humidity is low. To avoid possible damage to the plug-in module, touch any metal object (a metal desk lamp, a door knob, etc.) before handling the module. If static electricity is a problem in your area, you may want to have your carpet treated with a substance that reduces static electricity build-up. See your local carpet retailer for professional advice that relates to your specific situation.

Model _____

Serial No. _____

Purchase Date _____

This information on safety is provided to comply with U.S.A. laws, but should be observed by users in all countries.

Litiumbatteri!
Bör endast bytas av servicepersonal.
Explosionsfara vid felaktig hantering.

VAROITUS!
Lithiumparisto, Räjähdysvaara.
Pariston saa vaihtaa ainoastaan alan
ammattimies.



ADVARSEL!
Lithiumbatteri!
Eksplosionsfare. Udskiftning må kun foretages
af en sagkyndig, – og som beskrevet i
servicemanualen.

SERVICE

This product is supported by YAMAHA's worldwide network of factory trained and qualified dealer service personnel. In the event of a problem, contact your nearest YAMAHA dealer.

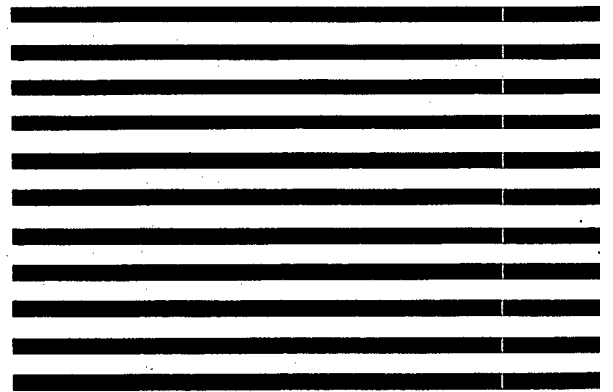
YAMAHA



YAMAHA CORPORATION
P.O.Box 1, Hamamatsu, Jap
9002 5.0 R2   Printed in Jap

SY55 VOICE EDIT REFERENCE

● PRESET VOICE LIST

No.	EL*	Name	No.	EL	Name	No.	EL	Name
1	1	Piano	23	4	Big Band	45	2	VCO Lead
2	2	Voyager	24	2	Orch Brass	46	2	Spirit VCF
3	2	Pro55Brass	25	2	SynthBrass	47	2	OZ Lead
4	2	Elektrodes	26	1	Flute	48	4	Get Lucky
5	4	Zuratustra	27	1	Saxophone	49	4	Gamma Band
6	2	DawnChorus	28	2	FolkGuitar	50	2	Metal Reed
7	2	GX Dream	29	2	12 String	51	4	Modomatic
8	2	GrooveKing	30	2	MuteGuitar	52	2	DataStream
9	4	DistGuitar	31	2	SingleCoil	53	2	Mystichoir
10	4	ZenAirBell	32	1	Pick Bass	54	2	St.Michael
11	2	FullString	33	2	Thumb Bass	55	2	Scatter
12	4	Jazz Man	34	2	SynBadBass	56	2	Triton
13	2	ClassPiano	35	2	VCO Bass	57	4	Amazon
14	2	Rock Piano	36	2	Violin	58	2	SatinGlass
15	1	DX E.Piano	37	1	ChamberStr	59	4	BrassChime
16	2	Hard EP	38	2	VCF String	60	2	Piano Mist
17	2	Cry Clav	39	2	Nova Quire	61	4	Xanadu
18	2	Funky Clav	40	2	Vibraphone	62	2	WdBass Duo
19	2	Deep Organ	41	2	Takerimba	63	(61)	Drum Set 1
20	2	Warm Organ	42	1	Gloken	64	(61)	Drum Set 2
21	1	Trumpet	43	2	DigiBell			
22	4	Stab Brass	44	2	Oriental			

* EL=Number of elements.

● PRESET WAVE LIST

No.	Name.	No.	Name	No.	Name	No.	Name
1	Piano	21	GtrSteel	41	Digital2	61	BD3
2	E.Piano1	22	GtrGut	42	Digital3	62	SD 1
3	E.Piano2	23	12string	43	Pulse 10	63	SD2
4	E.Piano3	24	E.Guitar	44	Pulse 25	64	SD3
5	E.Piano4	25	E.Bass	45	Pulse 50	65	Rim
6	E.Piano5	26	Popping	46	Tri	66	Tom 1
7	E.Piano6	27	WoodBass	47	Voice	67	Tom 2
8	E.Piano7	28	Syn Bass	48	Piano Np	68	HHclosed
9	Harpsi	29	Violin	49	EPianoNp	69	HH open
10	Organ 1	30	Strings	50	Vibe Np	70	Crash
11	Organ 2	31	Chorus	51	Bottle	71	Ride
12	Pipe	32	Itopia	52	Tuba	72	Claps
13	Trumpet	33	Vibe	53	Vocal Ga	73	Cowbell
14	Mute Tp	34	Marimba	54	Bamboo	74	Shaker
15	Trombone	35	Glocken	55	Noise		
16	Flugel	36	Shamisen	56	Styroll		
17	Sax	37	Harp	57	Bulb		
18	Flute	38	Mtl Reed	58	Bell Mix		
19	Brass	39	Saw	59	BD 1		
20	SynBrass	40	Digital1	60	BD 2		

YAMAHA

YAMAHA CORPORATION
P.O.Box 1, Hamamatsu, Japan
Printed In Japan

● SY55 Voice Edit Parameters

- 1. VOICE Mode
- 2. Wave Select
- 3. Volume
- 4. Note Shift
- 5. Detune
- 6. NoteLimit/L
- 7. NoteLimit/H
- 8. Vel.Limit/L
- 9. Vel. Limit/H
- 10. Pan
- 11. EF Balance
- 12. OSC Freq.Mode
OSC Freq.Note
OSC Freq.Tune
- 13. AEG Mode
AEG R1/HT
AEG R2
AEG L2
AEG R3
AEG L3
AEG R4
AEG RR
AEG RL
- 14. AEG R.Scale
- 15. AEG LS BP1
AEG LS BP2
AEG LS BP3
AEG LS BP4
- 16. AEG LS OFS1
AEG LS OFS2
AEG LS OFS3
AEG LS OFS4
- 17. Sens. Vel.
Sens. V.Rate
Sens. AMS
Sens. PMS
- 18. LFO Wave
LFO Speed
LFO Delay
LFO Phase
- 19. LFO AMOD
LFO PMOD
LFO CutoffMOD
- 20. PEG L0
PEG R1
PEG L1
PEG R2
PEG L2
PEG R3
PEG L3
PEG RR
PEG RL
- 21. PEG Range
PEG R.Scale
PEG Vel.SW

- F I L T E R
- 22. FLType
FLCutoff
FLMode
 - 23. FLICEG L0
FLICEG R1
FLICEG L1
FLICEG R2
FLICEG L2
FLICEG R3
FLICEG L3
FLICEG R4
FLICEG L4
FLICEG RR1
FLICEG RL1
FLICEG RR2
FLICEG RL2
 - 24. FLR.Scale
 - 25. FLIS BP1
FLIS BP2
FLIS BP3
FLIS BP4
 - 26. FLIS OFS1
FLIS OFS2
FLIS OFS3
FLIS OFS4
 - 27. FLResonance
FLVel.Sens
FLMod.Sens

- C
O
N
T
R
O
L
L
E
R
- 28. Element Initialize
 - 29. CNTL\Pitch Bend
 - 30. CNTLAT P.Bias
 - 31. CNTL\RandomPitch
 - 32. CNTL\AMOD CTL#
CNTL\AMOD RNG
 - 33. CNTL\PMOD CTL#
CNTL\PMOD RNG
 - 34. CNTL\CoffMOD CTL#
CNTL\CoffMOD RNG
 - 35. CNTL\Cutoff CTL#
CNTL\Cutoff RNG
 - 36. CNTL\EG Bias CTL#
CNTL\EG Bias RNG
 - 37. CNTL\Volume CTL#
CNTL\Volume MIN
 - 38. EFType
EFOutput.Level
 - 39. EF** Others**
 - 40. VOICE Name
 - 41. VOICE Edit Recall
 - 42. VOICE Initialize

Shaded blocks represent parameters available within a single job display.

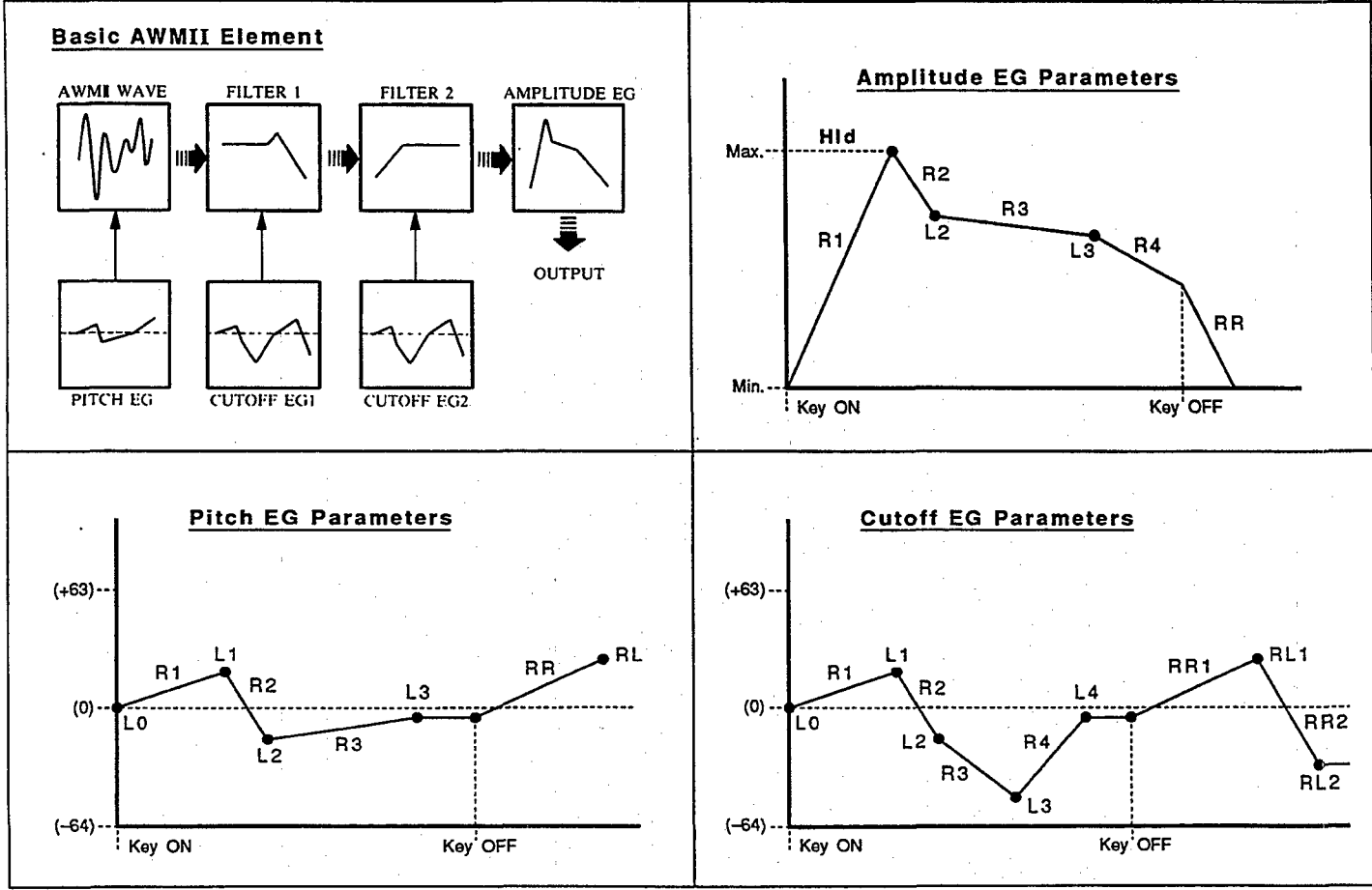

SY55 SEQUENCER REFERENCE

• BASIC RECORDING PROCEDURE FLOW

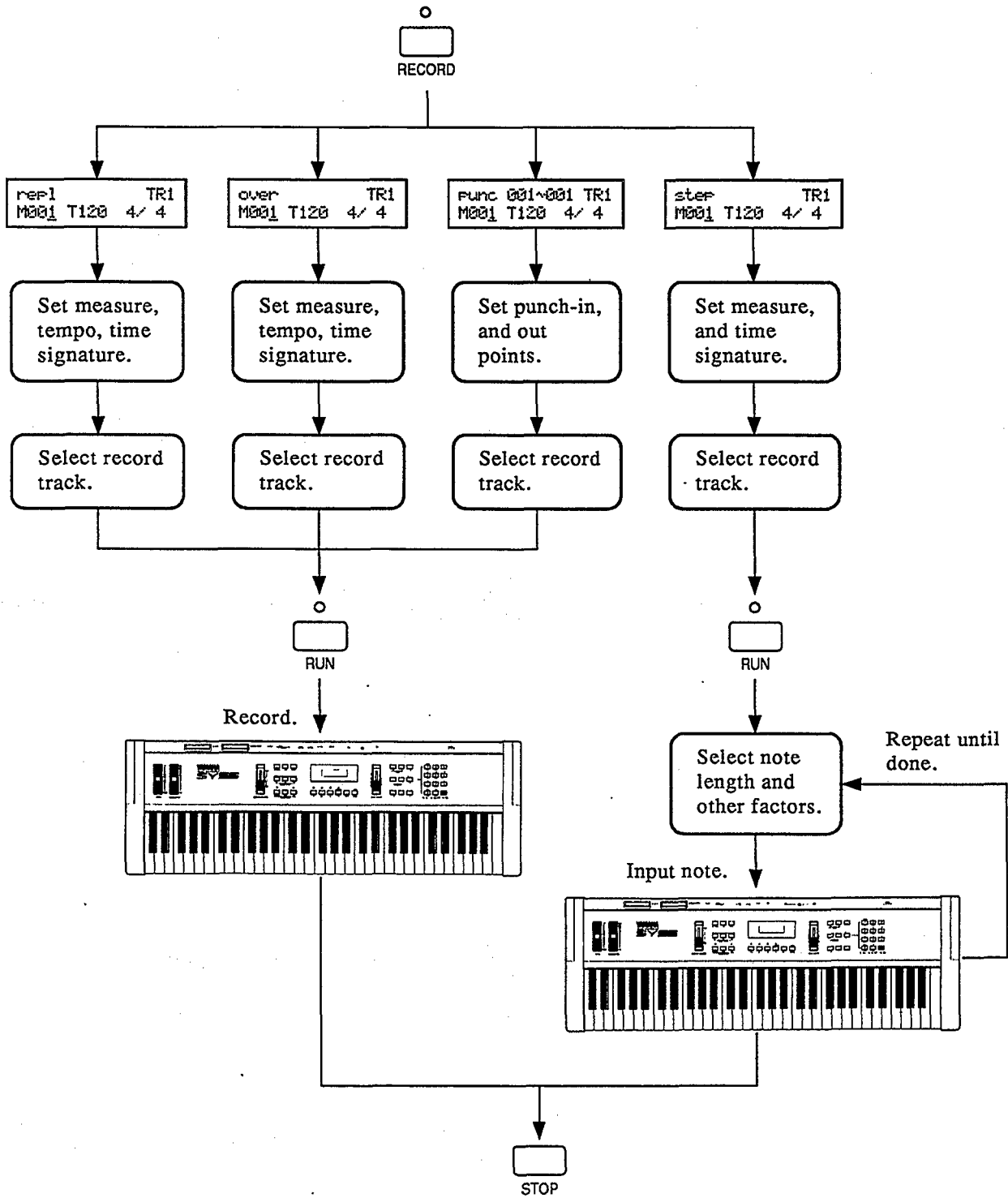

● SEQUENCER RECORD/PLAY & EDIT MODE JOBS

SEQUENCER RECORD & PLAY MODES

1. MEASURE, TEMPO & TIME SIGNATURE
2. CLICK SELECT
3. SYNC SELECT
4. TRACK TRANSIT CHANNEL
5. RECORD CHANNEL & FREE AREA
6. RECORD FILTER
7. MIDI CONTROL

SEQUENCER EDIT MODE

1. MIXDOWN

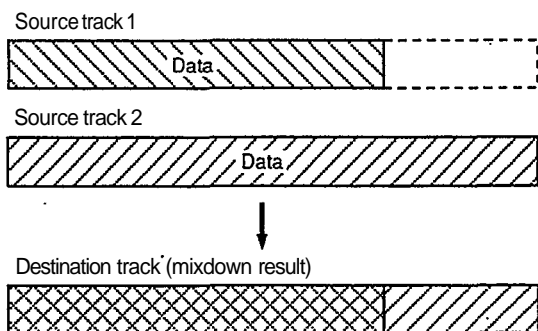

2. QUANTIZE

One measure of 8th notes before quantization.

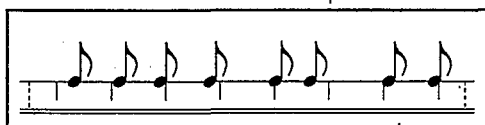

After quantization.



3. DELETE

Delete M004—006



Measure 4 through 6 deleted.

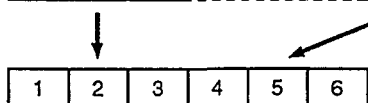
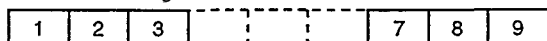

Subsequent measures moved back.

4. INSERT

Insert M002—004 → 006



Measure 6 moved up; measures 2,3 and 4 inserted.

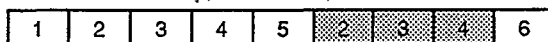

Result with new measure numbers.

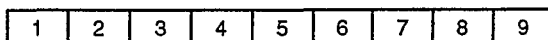

5. COPY

Copy TR1 → TR2

M003 — 005 → M006

● TRACK 1



● TRACK 2

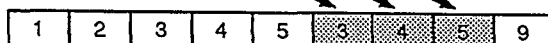

● TRACK 2 (Result with new measure numbers.)

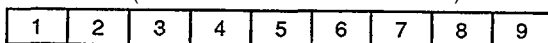

6. ERASE

Erase TR1 M004 — 006

● TRACK 1



● TRACK 1

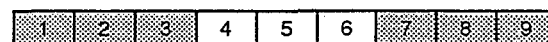

Measures 4 — 6
"blank," contain
only rests.

7. REMOVE EVENT

8. SONG NAME

9. SONG PROGRAM

10. SONG CLEAR

YAMAHA

YAMAHA CORPORATION
P.O.Box 1, Hamamatsu, Japan
Printed in Japan

YAMAHA

MUSIC SYNTHESIZER

SY55

MIDI DATA FORMAT

SYNTHESIZER PART

(1) TRANSMIT FLOW

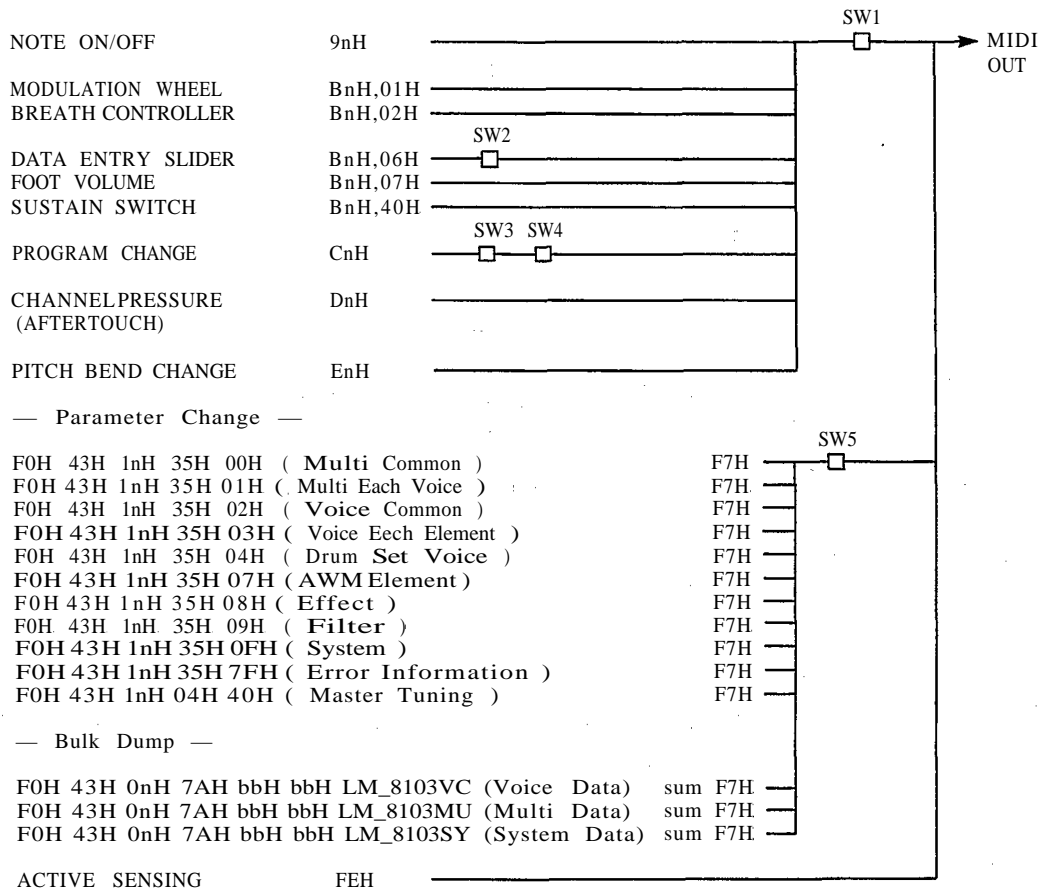

- SW1 MIDI Transmit Channel
MIDI transmit channel 1 ~ 16 or OMNI ON selection.
- SW2 Transmitted in the play mode only.
- SW3 Transmitted in the play mode only.
- SW4 Program Change Mode Select
Program change transmit on/off, normal mode or direct mode selection.
- SW5 System Exclusive Message Transmit Channel
System exclusive message on/off, and device number selection.

(2) RECEIVE FLOW

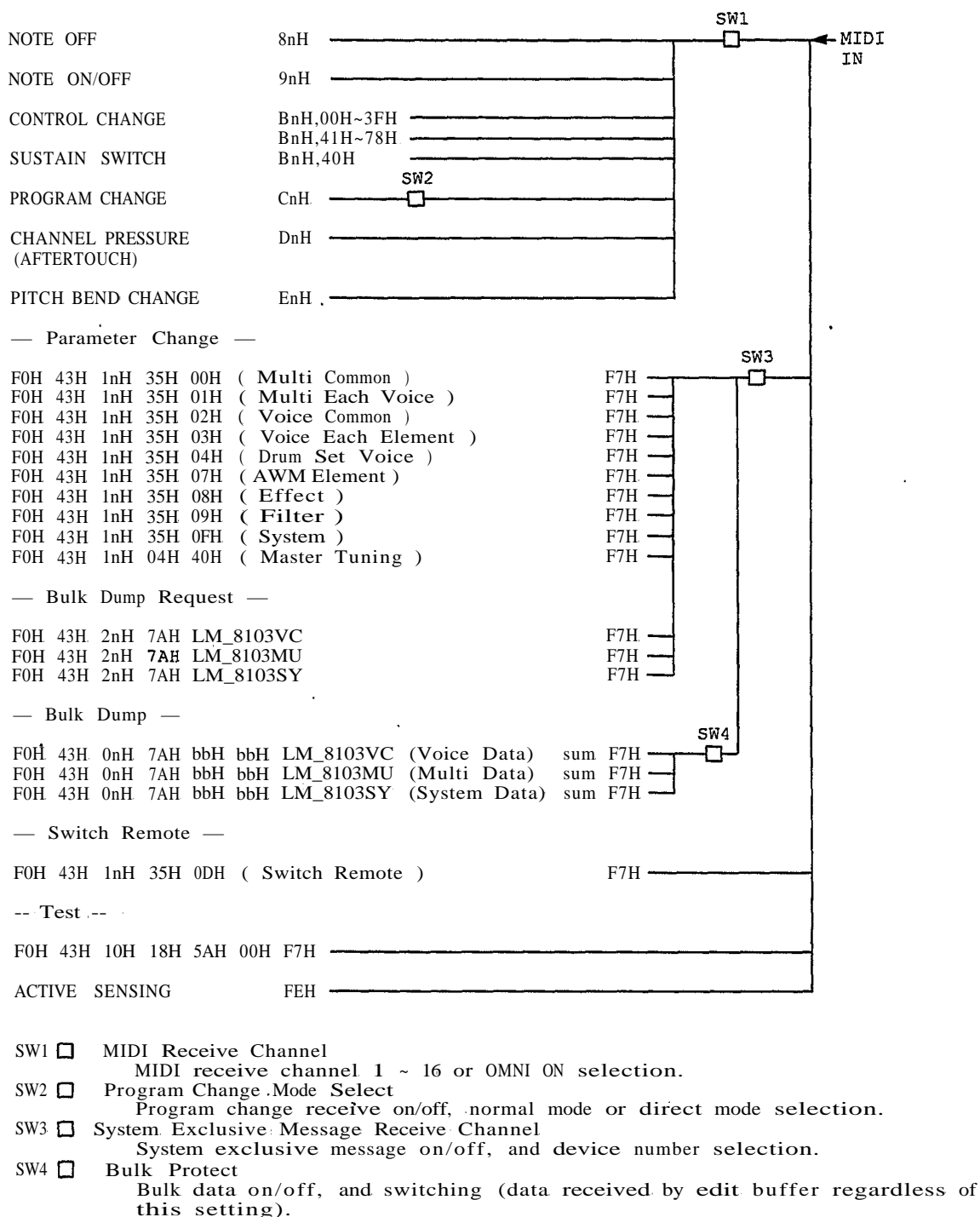

(3) TRANSMIT/RECEIVE DATA

(3-1) CHANNEL VOICE MESSAGES

(3-1-1) NOTE OFF

STATUS	1000nnnnB	(8nH)	n = VOICE CHANNEL NUMBER
NOTE NUMBER	0kkkkkkkB		k = 0 (C-2) ~ 127 (G8)
VELOCITY	0vvvvvvvB		Ignored

Receive only.

(3-1-2) NOTE OH/OFF

STATUS	1001nnnnB	(9nH)	n = VOICE CHANNEL NUMBER
NOTE NUMBER	0kkkkkkkB		k = 36 (C1) ~ 96 (C6) (transmit)
			k = 0 (C-2) ~ 127 (G8) (receive)
VELOCITY	0vvvvvvvB	(v ≠ 0)	NOTE ON
	0000000B	(v = 0)	NOTE OFF

* The following system data options are available for NOTE OFF and/or NOTE ON/OFF reception:

- all = all note numbers received.
- odd = only odd note numbers received.
- even = only even note numbers received.

(3-1-3) CONTROL CHANGE

STATUS	1011nnnnB	(BnH)	n = VOICE CHANNEL NUMBER
CONTROL NUMBER	0cccccccB		
CONTROL VALUE	0vvvvvvvB		

* The transmitted control number.

c = 1	MODULATION WHEEL	v = 0 ~ 127
c = 2	BREATH CONTROLLER	v = 0 ~ 127
c = 6	DATA ENTRY SLIDER (AT PLAY MODE)	v = 0 ~ 127
c = 7	FOOT VOLUME	v = 0 ~ 127
c = 64	SUSTAIN SWITCH	v = 0 : OFF, 127 : ON

* The received control number.

c = 0 ~ 120 These control numbers can be assigned to the following.

- Pitch Modulation
- Amplitude Modulation
- Filter Modulation
- Filter Cutoff
- EG Bias
- Voice Volume

v = 0 - 127

c = 64 SUSTAIN SWITCH

v ≠ 0 ~ 63 : OFF , 64 ~ 127:ON

(3-1-4) PROGRAM CHANGE

[NORMAL MODE]

STATUS	1100nnnnB	(CnH)	n = VOICE CHANNEL NUMBER
PROGRAM NUMBER	0pppppppB		p = 0 - 63 (VOICE)
			64 ~ 79 (MULTI)

[DIRECT MODE]

- * Voice or multi number select.
- * Select multi-play setup voices.

STATUS 1100nnnnB (CnH) n ≙ VOICE CHANNEL NUMBER
 PROGRAM NUMBER OpppppppB p = 0 ~ 63 (VOICE)
 64 ~ 79 (MULTI)

* Select multi-play setup voices.
 * Mode or memory select.

STATUS 1100nnnnB (CnH) n ≙ VOICE CHANNEL NUMBER
 MODE/MEMORY OddddddB d = 119 ~ 127
 NUMBER
 PROGRAM NUMBER OpppppppB p = 0 ~ 63 (VOICE)
 64 ~ 79 (MULTI)

* MODE/MEMORY NUMBER

d = 119	INDIVIDUAL	INTERNAL	
d = 120	INDIVIDUAL	CARD	
(INTERNAL and CARD cannot be combined in one MULTI.)			
d ≙ 121	INDIVIDUAL	PRESET	
d = 122	COMMON	VOICE PLAY MODE	INTERNAL
d ≙ 123	COMMON	VOICE PLAY MODE	CARD
d ≙ 124	COMMON	VOICE PLAY MODE	PRESET
d ≙ 125	COMMON	MULTI PLAY MODE	INTERNAL
d = 126	COMMON	MULTI PLAY MODE	CARD
d ≙ 127	COMMON	MULTI PLAY MODE	PRESET

Transmitted in the play mode only.

Reception/transmission ON/OFF, normal mode or direct mode can be selected.

Sequencer receives and transmits in direct mode at all times.

NORMAL MODE

Select voice or multi number only.
 Mode or memory cannot be selected.

[Transmit]

VOICE PLAY MODE :

Voice number transmitted if voice number changed.
 p ≙ 0 ~ 63

MULTI PLAY MODE :

Multi number + 64 transmitted if multi number changed.
 p = 64 ~ 79
 Voice number transmitted if voice number in multi-play setup changed.
 p = 0 ~ 63

[Receive]

VOICE PLAY MODE :

p = 0 ~ 63 Voice select.
 p 64 ~ 127 Ignored

MULTI PLAY MODE :

p = 0 ~ 63 Change multi-play setup voice.
 p = 64 ~ 79 Select multi-play setup.
 p = 80 ~ 127 Ignored

DIRECT MODE

Mode and memory number select in addition to voice and multi number select.

[Transmit]

d = 119 ~ 127
Changes transmitted as:
p = 0 ~ 63 (VOICE)
64 ~ 79 (MULTI)

[Receive]

Voice or multi number select.
Change multi-play setup voice.

VOICE PLAY MODE

p = 0 ~ 63 Voice select.
p = 64 ~ 118 Ignored

MULTI PLAY MODE

p = 0 ~ 63 Change multi-play setup voice.
p = 64 ~ 79 Select multi-play setup.
p = 80 ~ 118 Ignored

Change multi-play setup.
Select mode or memory.

d = 119 ~ 127 Program change occurs when next program change message received.

d = 119 ~ 121
p = 0 ~ 63 Change multi-play setup.
d = 119, 120

Internal voice selected if preset multi currently active.
Voice with same memory number as multi selected if internal or card multi currently active.

d = 122 ~ 124
p = 0 ~ 63 (VOICE)
or
d = 125 ~ 127
p = 64 ~ 79 (MULTI)
changes mode, memory, voice or multi number.

(3-1-5) CHANNEL PRESSURE / AFTERTOUCHE

STATUS 1101nnnnB (DnH) n = VOICE CHANNEL NUMBER
PRESSURE VALUE 0vvvvvvvB v = 0 ~ 127

Aftertouch can be assigned to the following functions:

Pitch Modulation
Amplitude Modulation
Filter Modulation
Filter Cutoff
EG Bias
Voice Volume

(3-1-6) PITCH BEND CHANGE

STATUS 1110nnnnB (EnH) n = VOICE CHANNEL NUMBER
LSB 0vvvvvvvB PITCH BEND CHANGE LSB
MSB 0vvvvvvvB PITCH BEND CHANGE MSB

7-bit resolution.

The data transmitted is as shown below.

MSB	LSB	
00000000B (00H)	00000000B (00H)	Min.
01000000B (40H)	00000000B (00H)	Center
01111111B (7FH)	01111110B (7EH)	Max

For reception, only the MSB data is operational.

MSB	
00000000B (00H)	Min.
01000000B (40H)	Center
01111111B (7FH)	Max.

(3-2) SYSTEM REAL TIME MESSAGES

(3-2-1) ACTIVE SENSING

STATUS 1111110B (FEH)

Transmitted approximately every 270 milliseconds.

Sensing begins when this code is received. If no status or data received for more than approximately 330 milliseconds, the MIDI received buffer is cleared and all notes/sustain switch are forced off. All control values are initialized.

(3-3) SYSTEM EXCLUSIVE MESSAGES

No exclusive messages received in demo mode - except remote switch.

(3-3-1) PARAMETER CHANGE

STATUS	11110000B	(F0H)	
IDENTIFICATION	01000011B	(43H)	
SUB STATUS	0001nnnnB	(1nH)	n = DEVICE NUMBER
GROUP NUMBER	00110101B	(35H)	
STRUCTURE NUMBER MSB	0000ttttB		
STRUCTURE NUMBER LSB	0feennnnB		
PARAMETER NUMBER MSB	0pppppppB		
PARAMETER NUMBER LSB	0pppppppB		
PARAMETER VALUE MSB	0vvvvvvvB		
PARAMETER VALUE LSB	0vvvvvvvB		
EOX	11110111B	(F7H)	

The 10 parameter change messages from MULTI COMMON to SYSTEM shown in the chart below are received; ERROR INFORMATION is transmitted.
Device number and receive/transmit on/off can be set in the utility mode.

Switch remote reception occurs regardless of reception on/off or device number settings.

These parameter change messages allow remote control of all panel switches, producing the same effect as if the corresponding panel switch was actually pressed.

Of all the system parameters, only the format of MASTER TUNING is different. Refer to chart 8.

Type	t	f	e	n	Refer to
MULTI COMMON	00H	-	-	-	chart 1
MULTI EACH VOICE	01H	-	-	channel#	chart 1
VOICE COMMON	02H	-	-	-	chart 2
VOICE EACH ELEMENT	03H	-	element#	-	chart 2
DRUM SET VOICE	04H	key note number			chart 3
AWM ELEMENT	07H	-	element#	-	chart 4
EFFECT	08H	-	-	-	chart 5
FILTER	09H	filter#	element#	-	chart 6
SWITCH REMOTE	0DH	-	-	-	chart 7
SYSTEM	0FH	-	-	-	chart 8
ERROR INFORMATION	7FH	-	-	-	chart 9

- note)
- * element number 0 (EL1) ~ 3 (EL4)
 - * channel number 0 (CH1) ~ 15 (CH16)
 - * filter number 0 : filter #1
1 : filter #2
don't care : filter common
 - * key note number 36 (C1) ~ 96 (C6)
 - * Unused bits of the structure number LSB are transmitted as 0's and ignored when received.
 - * The unused bit of the parameter number MSB are transmitted as 0's and ignored when received.
 - * Error information is transmitted when an error occurs.

(3-3-2) BULK DUMP

STATUS	11110000B	(F0H)	
IDENTIFICATION	01000011B	(43H)	
SUB STATUS	0000nnnnB	(0nH)	n = DEVICE NUMBER
FORMAT NUMBER	01111010B	(7AH)	
BYTE COUNT(MSB)	0bbbbbbbB		
BYTE COUNT(LSB)	0bbbbbbbB		
CLASSIFICATION	01001100B	(4CH)	ASCII'L
NAME	01001101B	(4DH)	ASCII'M
	00100000B	(20H)	ASCII'_'
	00100000B	(20H)	ASCII'_'
DATA FORMAT	00111000B	(38H)	ASCII'8
NAME	00110001B	(31H)	ASCII'1
	00110000B	(30H)	ASCII'0
	00110011B	(33H)	ASCII'3
	0mmmmmmB		ASCII
	0mmmmmmB		ASCII
ADDITIONAL	00000000B	(00H)	
HEADER	00000000B	(00H)	
	00000000B	(00H)	
	00000000B	(00H)	
	00000000B	(00H)	
	00000000B	(00H)	
	00000000B	(00H)	
	00000000B	(00H)	
	00000000B	(00H)	
	00000000B	(00H)	
	00000000B	(00H)	
	00000000B	(00H)	
	00000000B	(00H)	
	00000000B	(00H)	
	00000000B	(00H)	
MEMORY TYPE	0xxxxxxxB		
MEMORY NUMBER	0yyyyyyyB		
DATA	0dddddddB		
	↓		
	0dddddddB		
CHECK SUM	0eeeeeeeB		2's complement of 7 bits sum of all data bytes
EOX	11110111B	(F7H)	

data bytes

The 3 types of bulk data shown in the chart below are transmitted and received. Device number, receive/transmit on/off and receive protect can be set in the utility mode.
 Received to edit buffer regardless of protect setting.

Type	b	m	x	y	Refer to
VOICE	1AWM 01H 38H 2AWM 02H 31H 4AWM 04H 23H DRUM SET 04H 64H	VC	INTERNAL 00H PRESET 02H EDIT BUFFER 7FH	00H~3FH	chart 10
MULTI	01H 3AH	MU		00H~0FH	chart 11
SYSTEM	00H 2AH	SY	00H	00H	chart 12

NOTE)

For 1 voice or 1 multi bulk dump transmission, memory type = edit buffer, and memory number = 00H.
 When a memory type = edit buffer bulk dump is received, the memory number is ignored.
 Received to voice edit buffer only in voice mode.
 Received to multi edit buffer only in multi mode.
 All voice or all multi bulk dump transmission are carried out with the selected memory type and the appropriate voice multi memory number.

When a bulk dump other than a memory type = edit buffer type is received, memory type is processed as internal. Unused memory number bits are ignored.

If a system bulk dump is received, the memory type and memory number are ignored.

Unused bytes in the additional header (00H) are ignored when received.

When successive bulk dumps are transmitted, an interval of greater than approximately 100 milliseconds is inserted between each. This interval is also necessary between bulk dumps received.

(3-3-3) BULK DUMP REQUEST

STATUS	11110000B	(F0H)	
IDENTIFICATION	01000011B	(43H)	
SUB STATUS	0010nnnnB	(2nH)	n = DEVICE NUMBER
FORMAT NUMBER	01111010B	(7AH)	
CLASSIFICATION	01001100B	(4CH)	ASCII'L
NAME	01001101B	(4DH)	ASCII'M
	00100000B	(20H)	ASCII'_
	00100000B	(20H)	ASCII'_
DATA FORMAT	00111000B	(38H)	ASCII'8
NAME	00110001B	(31H)	ASCII'1
	00110000B	(30H)	ASCII'0
	00110011B	(33H)	ASCII'3
	0mmmmmmmmB		ASCII
	0mmmmmmmmB		ASCII
ADDITIONAL	0000000B	(00H)	
HEADER	0000000B	(00H)	
	0000000B	(00H)	
	0000000B	(00H)	
	0000000B	(00H)	
	0000000B	(00H)	
	0000000B	(00H)	
	0000000B	(00H)	
	0000000B	(00H)	
	0000000B	(00H)	
	0000000B	(00H)	
	0000000B	(00H)	
	0000000B	(00H)	
	0000000B	(00H)	
MEMORY TYPE	0xxxxxxxB		
MEMORY NUMBER	0yyyyyyyB		
EOX	11110111B	(F7H)	

The 3 types of bulk dump request shown in the chart below are received. Device number and receive on/off can be set in the utility mode.

Type	m	x	y
VOICE	VC	INTERNAL 00H PRESET 02H	00H-3FH
MULTI	MU	EDIT BUFFER 7FH	00H-0FH
SYSTEM	SY	00H	00H

NOTE)

Unused bytes in the additional header (00H) are ignored.
 When memory type = edit buffer, the memory number is ignored.
 When memory type ≠ edit buffer, the unused memory number bits are ignored.
 For the system bulk dump request, the memory type and memory number are ignored.

(4) Keyboard, sequencer and tone generator section.

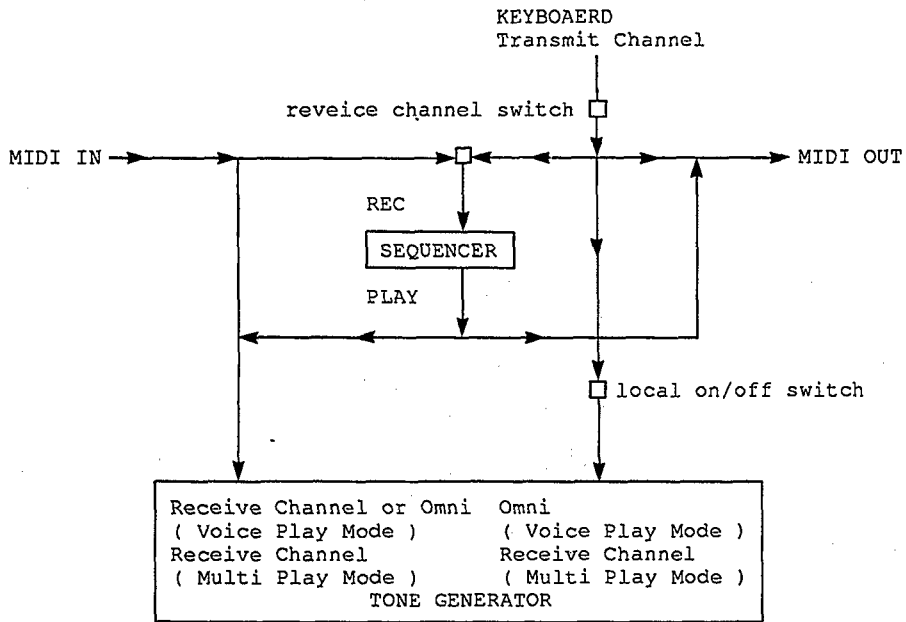

- note) * Note on messages from the keyboard are transmitted in the voice play mode whether the receive and transmit channel are matched or not.
- * Keyboard, sequencer and MIDI note on messages are separated. Keyboard, sequencer, and MIDI control data, with the exception of sustain, are not separated. Sustain is separated.

[CHART 1] Parameter Table (MULTI)

(1) Multi Header

MIDI Parameter Change Format

F0H 43H 1nH 35H 00H 00H 00H n2H 00H v2H F7H

note) n ; device number
 n2 ; parameter number
 v2 ; parameter value

No.	n2	function	value	note
0	00	-- Multi Voice Set Name --		
1	01	"*"	v2 : 20-127	
2	02	" *"	v2 : 20-127	
3	03	" *"	v2 : 20-127	
4	04	" *"	v2 : 20-127	
5	05	" *"	v2 : 20-127	
6	06	" *"	v2 : 20-127	
7	07	" *"	v2 : 20-127	
8	08	" *"	v2 : 20-127	
9	09	" *"	v2 : 20-127	
10	0A	Effect Source Select	v2 : 0-16	0:multi, 1-16:1-16ch

(2) Multi Each Voice

MIDI Parameter Change Format

F0H 43H 1nH 35H 01H t2H n1H n2H 00H v2H F7H

note) n ; device number
 t2 ; voice channel number
 n1 ; parameter number MSB
 n2 ; parameter number LSB
 v2 ; parameter value

No.	n2	function	value	note
0	00	Voice on/off Output Select (only TG55)	v2: b6 0-1 b0,1,2 0-5	0:off, 1:on 0:STR, 1:OFF, 2:1, 3:2, 4:12 5:VCE
1	01	Voice Memory Select	v2 : 0-1	0:int/crd, 1:pre
2	02	Voice Number	v2 : 0-63	
3	03	Volume	v2 : 0-127	
4	04	Tuning	v2 : 0-127	0-127:-64~+63
5	05	Note Shift	v2 : 0-127	0-127:-64~+63
6	06	Multi Static PAN	v2 : 0-63	0:voice, 1-63:-31~+31 If a mode other than VOICE is selected, voice pan will not operate.
7	07	Effect Level	v2 : 0-100	
8	08	Reserve Note	v2 : 0-16	

note) * The SY55 transmits parameter change when output select b0,1,2 = 7.
 When the TG55 receives this value, the current output select value does not change.

* The SY55 transmits bulk dump when output select b0,1,2 = 0.
 Thus, when the TG55 receives a bulk dump from the SY55, output select becomes stereo L,R.

- * When n2 = 00, n1 is used to display the edit screen shown during reception.
 n1=1 Output select
 n1=2 Voice on/off
 When n1 is a value other than 1, the voice on/off edit screen is displayed.
 The value changes with output select and voice on/off regardless of n1.
- * When voice on/off is set to "off", the LCD changes to the edit screen when a volume - reserve note parameter change is received, but the value does not change.
 Voice on/off is forced on when a voice number is received.

[CHART 2] Parameter Table (VOICE)

(1) Voice Header

MIDI Parameter Change Format

F0H 43H 1nH 35H 02H 00H 00H n2H 00H v2H F7H

note) n ; device number
 n2 ; parameter number
 v2 ; parameter value

No.	n2	function	value	note
0	00	--- Element Select Mode --- Mode	v2 : 5-7,10	5:1AWM_poly 6:2AWM_poly 7:4AWM_poly 10:DRUM_SET
1	01	--- Voice Name --- "*	v2 : 20-127	
2	02	" *	v2 : 20-127	
3	03	" *	v2 : 20-127	
4	04	" *	v2 : 20-127	
5	05	" * *	v2 : 20-127	
6	06	" * *	v2 : 20-127	
7	07	" * *	v2 : 20-127	
8	08	" * *	v2 : 20-127	
9	09	" * *	v2 : 20-127	
10	0A	" *"	v2 : 20-127	

note) * Element select mode 5 - 7 can be selected for voice number 1 - 62.
 The element select mode is fixed at 10 for voice number 63 and 64.

(2) Voice Common

MIDI Parameter Change Format

F0H 43H 1nH 35H 02H 00H 00H n2H 00H v2H F7H

note) n ; device number
 n2 ; parameter number
 v2 ; parameter value

No.	n2	function	value	note
0	10	---Pitch Bend Wheel --- Range	v2 : 0-12	
1	11	--- After Touch Pitch Bend --- Pitch Bend Range	v2 : 0-12,16-28	0-12:0~+12 16-28:0~-12A (bit4 = sign bit)

No.	n2	function	value	note
2	12	--- Pitch Modulation --- Device Assign (MIDI Control#)	v2 : 0-121	0-120:0-120, 121:AT
3	13	Modulation Range	v2 : 0-127	
4	14	---AmplitudeModulation--- Device Assign (MIDI Control#)	v2 : 0-121	0-120:0-120, 121:AT
5	15	Modulation Range	v2 : 0-127	
6	16	--- FiLter Modulation --- Device Assign (MIDI Control#)	v2 : 0-121	0-120:0-120, 121:AT
7	17	Modulation Range	v2 : 0-127	
8	18	--- Filter Cut_off --- Device Assign (MIDI control#)	v2 : 0-121	0-120:0-120, 121:AT
9	19	Cut_off Range	v2 : 0-127	
10		Reserve	0	
11		Reserve	0	
12	1C	--- EG Bias --- Device assign (MIDI control#)	v2 : 0-121	0-120:0-120, 121:AT
13	ID	Bias Range	v2 : 0-127	
14*	IE	--- Voice Volume --- Device assign (MIDI control#)	v2 : 0-121	0-120:0-120, 121:AT
15*	IF	Volume Limit Low	v2 : 0-127	
16	20	Random Pitch Fluctuation	v2 : 0-7	
17	21	Output Select (only TG55)	v2 : 0-4	0:str, 1:off, 2:1, 3:2, 4:12
18*	22	Voice Volume	v2 : 0-127	
19*	23	AWM_card ID (MSB)	v2 : 0-127	(If 0:AWM_card not used, 1 ~ max. 16383)
20*	24	AWM_card ID (LSB)	v2 : 0-127	

note) * Only numbers with an asterisk (*) apply to drum set voices.
* The SY55 transmits bulk dump when output select = 0.
Thus, when the TG55 receives a bulk dump from the SY55, output select becomes stereo L,R.

(3) Element Enable

MIDI Parameter Change Format

F0H 43H InH 35H 02H 00H 00H 7FH 00H v2H F7H

v2 ; 0,0,0,0,e3,e2,e1,e0 on:1 off:0

(4) Voice Each Element

MIDI Parameter Change Format

F0H 43H InH 35H 03H t2H 00H n2H 00H v2H F7H

note) n ; device number
t2 ; 00ee0000B
ee 00 - element 0
01 - element 1
10 - element 2
11 - element 3
n2 ; parameter number
v2 ; parameter value

No.	n2	function	value	note
0	00	Element Volume	v2 : 0-127	
1	01	Element Detune	v2 : 0-15	0-7:0~+7, 8-15:0~-7 (bit3 = sign bit)
2	02	Element Note Shift	v2 : 0-127	0-127:-64~+63
3	03	---ElementLimit---		
4	04	Note Limit Low	v2 : 0-127	(note #)
5	05	Note Limit High	v2 : 0-127	(note #)
6	06	Velocity Limit Low	v2 : 1-127	(velocity #)
6	06	Velocity Limit High	v2 : 1-127	(velocity #)
7	07	Static Pan	v2 : 1-63	1-63:-31~+31 No effect when Multi Static PAN selected.
8	08	Effect Balance	v2 : 0-100	

[CHART 3] PARAMETER TABLE (DRUM SET VOICE)

MIDI Parameter Change Format

F0H 43H nH 35H 04H t2H n1H n2H v1H v2H F7H

note) n ; device number
t2 ; MIDI note number
n1 ; parameter number MSB
n2 ; parameter number LSB
v1 ; MSB of parameter value
v2 ; LSB of parameter value

No.	n2	function	value	note
0	00	Alternate Group Wave on/off Output Select (only TG55)	v2 : b6 0-1 b5 0-1 b0,1,2 0-4	0:off, 1:on 0:off, 1:on 0:str, 1:off, 2:1, 3:2, 4:12
1	01	Wave Source	v2 : 0-1	0:pre, 1:card
2	02	Wave Number	v1 : 0-1	(0~max.255)
3			v2 : 0-127	
4	03	Wave Volume	v2 : 0-127	0-127:-64~+63 16-100:-48~+36 1-63:-31~+31 No effect when Multi Static PAN selected.
5	04	Wave Tuning	v2 : 0-127	
6	05	Wave Note Shift	v2 : 16-100	
7	06	Static Pan	v2 : 1-63	
8	07	Effect Balance	v2 : 0~100	

- note) * The SY55 transmits parameter change when output select b0,1,2 = 7.
When the TG55 receives this value, the current output select value does not change.
- * The SY55 transmits bulk dump when output select b0,1,2 = 0.
Thus, when the TG55 receives a bulk dump from the SY55, output select becomes stereo L,R.
- * When n2 = 00, n1 is used to display the edit screen shown during reception.
n1=1 Output Select
n1=2 Wave on/off
n1=3 Alternate group

When n1 is a value other than 1 or 3, the wave on/off edit screen is displayed.
The value changes with output select, wave on/off and alternate regardless of n1.

* When wave on/off is set to "off", the LCD changes to the edit screen when a value does not change.

Wave on/off is forced on when a wave number is received.

[CHART 4] PARAMETER TABLE (AWM ELEMENT)

MIDI Parameter Change Format

F0H 43H 1nH 35H 07H t2H 00H n2H v1H v2H F7H

note) n ; device number
t2 ; 00ee0000B
ee 00 - element 0
01 - element 1
10 - element 2
11 - element 3
n2 ; parameter number
v1 ; MSB of parameter value
v2 ; LSB of parameter value

(1) AWM Element Data 1

No.	n2	function	value	note
0	00	Wave Source	v2 : 0-1	0:pre, 1:card
1	01	Wave Number	v1 : 0-1	(0~255)
2			v2 : 0-127	
3	02	Frequency Mode	v2 : 0-1	0:normal, 1:fixed
4	03	Fixed Mode Note#	v2 : 0-127	
5	04	Frequency Fine	v2 : 0-127	0-127:-64~+63
6	05	Pitch Modulation Sensitivity	v2 : 0-7	
--- Pitch_EG ---				
7	06	Key_on Rate 1	v2 : 0-63	
8	07	Key_on Rate 2	v2 : 0-63	
9	08	Key_on Rate 3	v2 : 0-63	
10	09	Key_off Rate 1	v2 : 0-63	
11	0A	Key_on Level 0	v2 : 0-127	0-127:-64~+63
12	0B	Key_on Level 1	v2 : 0-127	0-127:-64~+63
13	0C	Key_on Level 2	v2 : 0-127	0-127:-64~+63
14	0D	Key_on Level 3	v2 : 0-127	0-127:-64~+63
15	0E	Key_off Level 1	v2 : 0-127	0-127:-64~+63
16	0F	Range	v2 : 1-3	1:2, 2:1, 3:1/2 oct
17	10	Rate Scaling	v2 : 0-15	0-7:0~+7, 8-15:0-7 (bit3 = sign bit)
18	11	Velocity Switch	v2 : 0-1	0:off, 1:on
--- Multi LFO ---				
19	12	Speed	v2 : 0-99	
20	13	Delay Time	v2 : 0-99	
21	14	Pitch Modulation Depth	v2 : 0-127	
22	15	Amplitude Modulation Depth	v2 : 0-127	
23	16	Filter Modulation Depth	v2 : 0-127	
24	17	Wave	v2 : 0-5	0:Tri, 1:Dwn, 2:Up, 3:Squ, 4:Sine, 5:S/H
25	18	Initial Phase	v2 : 0-99	
26		Reserve	0	

(2) AWM Element Data 2

No.	n2	function	value	note
0	4F	--- Amplitude EG --- EG Mode	v2 : 0-1	0:normal, 1:hold
1	50	Key_on Rate 1 (attack/hold)	v2 : 0-63	
2	51	Key_on Rate 2 (decay)	v2 : 0-63	
3	52	Key_on Rate 3	v2 : 0-63	
4	53	Key_on Rate 4 (decay)	v2 : 0-63	
5	54	Key_off Rate 1 (release)	v2 : 0-63	
6	55	Key_on Level 2 (decay)	v2 : 0-63	
7	56	Key_on Level 3 (decay)	v2 : 0-63	
8	57	Rate Scaling	v2 : 0-15	0-7:0~+7, 8-15:0-7 (bit3 = sign bit)
9	58	Out_level Scaling Break Point 1	v2 : 0-127	(note #)
10	59	Out_level Scaling Break Point 2	v2 : 0-127	(note #)
11	5A	Out_level Scaling Break Point 3	v2 : 0-127	(note #)
12	5B	Out_level Scaling Break Point 4	v2 : 0-127	(note #)
13	5C	Out_level Scaling Offset 1	v1 : 0-1	(1-255:-127~+127)
14			v2 : 0-127	
15	5D	Out_level Scaling Offset 2	v1 : 0-1	(1-255:-127~+127)
16			v2 : 0-127	
17	5E	Out_level Scaling Offset 3	v1 : 0-1	(1-255:-127~+127)
18			v2 : 0-127	
19	5F	Out_level Scaling Offset 4	v1 : 0-1	(1-255:-127~+127)
20			v2 : 0-127	
21	60	Velocity Sensitivity Key_on	v2 : 0-15	0-7:0~+7, 8-15:0-7 (bit3 = sign bit)
22	61	Rate Velocity Switch Key_on	v2 : 0-1	0:off, 1:on
23	62	Amplitude Modulation Sens.	v2 : 0-15	0-7:0~+7, 8-15:0-7 (bit3 = sign bit)

[CHART 5] PARAMETER TABLE (EFFECT)

MIDI Parameter Change Format

F0H 43H 1nH 35H 08H 00H 00H n2H 00H v2H F7H

note) n ; device number
n2 ; parameter number
v2 ; parameter value

No.	n2	function	value	note
0	00	Reverb Effect Type	v2 : 1-34	
1	01	Reverb Effect Output Level	v2 : 0-100	
2	02	Reverb Effect Parameter 1	v2 :	
3	03	Reverb Effect Parameter 2	v2 :	
4	04	Reverb Effect Parameter 3	v2 :	

[CHART 6] PARAMETER TABLE (FILTER)

MIDI Parameter Change Format

F0H 43H 1nH 35H 09H t2H 00H n2H 00H v2H F7H

note) n ; device number
t2 ; 0fee0000B

f 0 - filter 1
 1 - filter 2
 don't care - filter common
 ee 00 - element 0
 01 - element 1
 10 - element 2
 11 - element 3
 n2 ; parameter number
 v2 ; parameter value

(1) Filter 1 & 2

No.	n2	function	value	note
0	00	Filter Type	v2 : 0-2	0:THR, 1:LPF, 2:HPF (2:HPF in Filter 1 only)
1	01	Cut_off Frequency	v2 : 0-127	
2	02	Filter Mode	v2 : 0-2	0:EG, 1:LFO, 2:EGVA
3	03	Key_on Rate 1	v2 : 0-63	
4	04	Key_on Rate 2	v2 : 0-63	
5	05	Key_on Rate 3	v2 : 0-63	
6	06	Key_on Rate 4	v2 : 0-63	
7	07	Key_off Rate 1	v2 : 0-63	
8	08	Key_off Rate 2	v2 : 0-63	
9	09	Key_on Cut_off Level 0	v2 : 0-127	0-127 :-64~+63
10	0A	Key_on Cut_off Level 1	v2 : 0-127	0-127 :-64~+63
11	0B	Key_on Cut_off Level 2	v2 : 0-127	0-127 :-64~+63
12	0C	Key_on Cut_off Level 3	v2 : 0-127	0-127 :-64~+63
13	0D	Key_on Cut_off Level 4	v2 : 0-127	0-127 :-64~+63
14	0E	Key_off Cut_off Level 1	v2 : 0-127	0-127 :-64~+63
15	0F	Key_off Cut_off Level 2	v2 : 0-127	0-127 :-64~+63
16	10	Rate Scaling	v2 : 0-15	0-7:0~+7, 8-15:0-7 (bit3 = sign bit)
17	11	C_off_lvl Scaling Break Point 1	v2 : 0-127	(note #)
18	12	C_off_lvl Scaling Break Point 2	v2 : 0-127	(note #)
19	13	C_off_lvl Scaling Break Point 3	v2 : 0-127	(note #)
20	14	C_off_lvl Scaling Break Point 4	v2 : 0-127	(note #)
21	15	C_off_lvl Scaling Offset 1	v1 : 0-1 v2 : 0-127	(1-255:-127~+127)
22				
23	16	C_off_lvl Scaling Offset 2	v1 : 0-1 v2 : 0-127	(1-255:-127~+127)
24				
25	17	C_off_lvl Scaling Offset 3	v1 : 0-1 v2 : 0-127	(1-255:-127~+127)
26				
27	18	C_off_lvl Scaling Offset 4	v1 : 0-1 v2 : 0-127	(1-255:-127~+127)
28				

(2) Filter Common

No.	n2	function	value	note
0	32	Resonance	v2 : 0-99	
1	33	Velocity Sensitivity Key_on	v2 : 0-15	0-7:0~+7, 8-15:0-7 (bit3 = sign bit)
2	34	Cut_off Modulation sensitivity	v2 : 0-15	0-7:0~+7, 8-15:0-7 (bit3 = sign bit)

[CHART 7] PARAMETER CHANGE TABLE (SWITCH REMOTE)

MIDI Parameter Change Format

F0H 43H 1nH 35H 0DH 00H 00H n2H 00H v2H F7H

note) n ; device number
 n2 ; parameter number
 v2 ; parameter value
 data range : off(00H~3FH),on(40H-7FH)

n2	switch	SY55
00	PRESET	o
01	>>	o
02	RUN	o
03	VOICE	o
04	EDIT/COMPARE	o
05	JOB	o
07	SELECT	o
08	EXIT	o
09	ENTER	o
0A	3	o
0B	6	o
0C	9	o
0E	CARD	o
0F	<<	o
10	STOP	o
11	MULTI	o
12	UTILITY	o
13	PAGE+	o
15	->	o
16	+1/YES	o
17	1	o
18	2	o
19	5	o
1A	8	o
1C	INTERNAL	o
1D	TOP	o
1E	REC	o
1F	SEQ	o
20	STORE/COPY	o
21	PAGE-	o
23	<-	o
24	-1/NO	o
25	0	o
26	1	o
27	4	o
28	7	o
7F	Initial Set	o

Switch numbers correspond to the following layout.

SY55

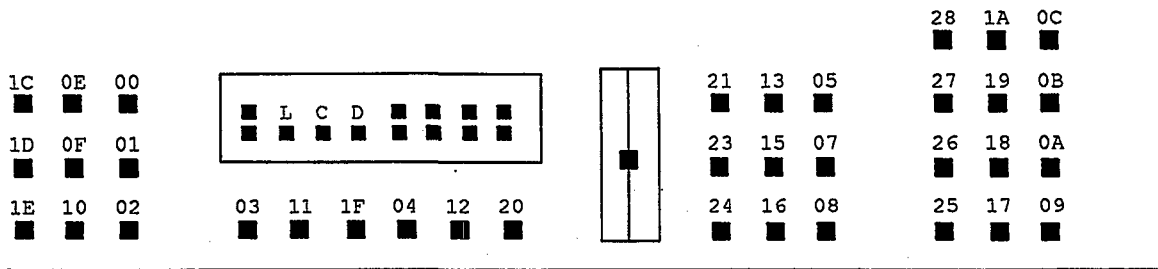

[CHART 8] PARAMETER TABLE (SYSTEM)

MIDI Parameter Change Format (Except Master Fine Tuning)

F0H 43H 1nH 35H 0FH 00H 00H n2H 00H v2H F7H

note) n ; device number
n2 ; parameter number
v2 ; parameter value

MIDI Parameter Change Format (Master Fine Tuning)

F0H 43H 1nH 04H 40H DTH F7H

note) n ; device number
DT ; parameter value

Same as DX1 Master Tuning

No.	n2	name	value	note
0 1	00	--- Master Tuning --- Master Note Shift Master Fine Tuning	v2 : 0-127 DT : 0-127	0-127:-64~+63 0-127:-64~+63
2	02	--- Velocity --- Velocity Curve Select	v2 : 0-7	0-4:1~8
3 4 5 6 7 8	03 04 05 06 07 08	--- MIDI --- Keyboard Transmit Channel Receive Channel Local Switch Device Number Bulk Data Memory Protect Switch Program Change Mode	v2 : 0-15 v2 : 0-16 v2 : 0-1 v2 : 0-17 v2 : 0-1 v2 : 0-2	0-15:1~16ch 0-15:1~16ch, 16:omni 0:off, 1:on 0:off, 1-16:1-16, 17:all 0:off, 1:on 0:off, 1:normal, 2:direct
9 10	09 0A	Effect on/off Card Bank Select 1 or 2	v2 : 0-1 v2 : 0-1	0:off, 1:on syn 0:bank1, 1:bank2
11	0B	Note on/off	v2 : 0-2	0:all, 1:odd, 2:even
12 13 14 15		Reserve Reserve Reserve Reserve	0 0 0 0	

note) * When "Device # = all" is selected, transmission occurs on device number 1.

[CHART 9] PARAMETER TABLE (ERROR INFORMATION)

MIDI Parameter Change Format

F0H 43H 1nH 35H 7FH 00H 00H 00H 00H v2H F7H

note) v2 ; error number

number	name
01	MIDI Buffer Full
02	SEQ Buffer Full
03	MIDI Data
04	MIDI Check Sum
05	MIDI Device# off
06	MIDI Bulk Prot.
07	No Data Card
08	Data Card Prot.
09	Data Card Format
0A	Illegal Data
0B	Verify Failed
0C	Internal Bat.Lo
0D	Data Card Bat.Lo
0E	SEQ Memory Full
0F	SEQ Data Empty
10	NowSEQRunning
11	Song Data Exist
12	Internal Bat.NG
13	Data Card Bat.NG
14	ID Mismatch
15	No Wave Card
16	Wrong Wave Card
17	Now SEQ Running
18	(not defined)
19	Voice Type
1A	Song Cleared
----- not error -----	
1E	Bulk Received
1F	Bulk Receiving
20	Bulk Canceled

[CHART 10] BULK DUMP FORMAT (VOICE)

(1) 1AWM

STATUS	11110000B	(F0H)	
IDENTIFICATION	01000011B	(43H)	
SUB STATUS	0000nnnnB	(0nH)	n = DEVICE NUMBER
FORMAT NUMBER	01111010B	(7AH)	
BYTE COUNT(MSB)	00000001B	(01H)	
BYTE COUNT(LSB)	00111000B	(38H)	(Byte Count = 184)
HEADER		26 byte	see (3-3-2) BULK DUMP
VOICE HEADER		11 byte	see chart 2
EFFECT		5 byte	see chart 5
VOICE COMMON		21 byte	see chart 2.
ELEMENT 0 DATA		9 byte	see chart 2
ELEMENT 0			
AWM ELEMENT DATA 1		27 byte	see chart 4
FILTER 1		29 byte	see chart 6
FILTER 2		29 byte	see chart 6
FILTER COMMON		3 byte	see chart 6
AWM ELEMENT DATA 2		24 byte	see chart 4
CHECK SUM	0eeeeeeB	2's complement of 7 bits sum of all data bytes	
EOX	11110111B	(F7H)	

(2) 2AWM

STATUS	11110000B	(F0H)	
IDENTIFICATION	01000011B	(43H)	
SUB STATUS	0000nnnnB	(0nH)	n = DEVICE NUMBER
FORMAT NUMBER	01111010B	(7AH)	
BYTE COUNT(MSB)	00000010B	(02H)	
BYTE COUNT(LSB)	00110001B	(31H)	(Byte Count = 305)
HEADER		26 byte	see (3-3-2) BULK DUMP
VOICE HEADER		11 byte	see chart 2
EFFECT		5 byte	see chart 5
VOICE COMMON		21 byte	see chart 2
ELEMENT 0 DATA		9 byte	see chart 2
ELEMENT 1 DATA		9 byte	see chart 2
ELEMENT 0			
AWM ELEMENT DATA 1		27 byte	see chart 4
FILTER 1		29 byte	see chart 6
FILTER 2		29 byte	see chart 6
FILTER COMMON		3 byte	see chart 6
AWM ELEMENT DATA 2		24 byte	see chart 4
ELEMENT 1			
AWM ELEMENT DATA 1		27 byte	see chart 4
FILTER 1		29 byte	see chart 6
FILTER 2		29 byte	see chart 6
FILTER COMMON		3 byte	see chart 6
AWM ELEMENT DATA 2		24 byte	see chart 4
CHECK SUM	0eeeeeeB	2's complement of 7 bits sum of all data bytes	
EOX	11110111B	(F7H)	

(3) 4AWM

STATUS	11110000B	(F0H)	
IDENTIFICATION	01000011B	(43H)	
SOB STATUS	0000nnnnB	(0nH)	n = DEVICE NUMBER
FORMAT NUMBER	01111010B	(7AH)	
BYTE COUNT(MSB)	00000100B	(04H)	
BYTE COUNT(LSB)	00100011B	(23H)	(Byte Count = 547)
HEADER		26 byte	see (3-3-2) BULK DUMP
VOICE HEADER		11 byte	see chart 2
EFFECT		5 byte	see chart 5
VOICE COMMON		21 byte	see chart 2
ELEMENT 0 DATA		9 byte	see chart 2
ELEMENT 1 DATA		9 byte	see chart 2
ELEMENT 2 DATA		9 byte	see chart 2
ELEMENT 3 DATA		9 byte	see chart 2
ELEMENT 0			
AWM ELEMENT DATA 1		27 byte	see chart 4
FILTER 1		29 byte	see chart 6
FILTER 2		29 byte	see chart 6
FILTER COMMON		3 byte	see chart 6
AWM ELEMENT DATA 2		24 byte	see chart 4
ELEMENT 1			
AWM ELEMENT DATA 1		27 byte	see chart 4
FILTER 1		29 byte	see chart 6
FILTER 2		29 byte	see chart 6
FILTER COMMON		3 byte	see chart 6
AWM ELEMENT DATA 2		24 byte	see chart 4
ELEMENT 2			
AWM ELEMENT DATA 1		27 byte	see chart 4
FILTER 1		29 byte	see chart 6
FILTER 2		29 byte	see chart 6
FILTER COMMON		3 byte	see chart 6
AWM ELEMENT DATA 2		24 byte	see chart 4
ELEMENT 3			
AWM ELEMENT DATA 1		27 byte	see chart 4
FILTER 1		29 byte	see chart 6
FILTER 2		29 byte	see chart 6
FILTER COMMON		3 byte	see chart 6
AWM ELEMENT DATA 2		24 byte	see chart 4
CHECK SUM	0eeeeeeB		2's complement of 7 bits sum of all data bytes
EOX	11110111B	(F7H)	

(4) DRUM SET

STATUS	11110000B	(F0H)	
IDENTIFICATION	01000011B	(43H)	
SUB STATUS	0000nnnnB	(0nH)	n = DEVICE NUMBER
FORMAT NUMBER	01111010B	(7AH)	
BYTE COUNT(MSB)	00000100B	(04H)	
BYTE COUNT(LSB)	01100100B	(64H)	(Byte Count = 612)
	HEADER	26 byte	see (3-3-2) BULK DUMP
	VOICE HEADER	11 byte	see chart 2
	EFFECT	5 byte	see chart 5
	VOICE COMMON	21 byte	see chart 2
	C1 DRUM SET VOICE	9 byte	see chart 3
	C6 DRUM SET VOICE	9 byte	see chart 3
CHECK SUM	0eeeeeeeB	2's complement of 7 bits sum of all data bytes	
EOX	11110111B	(F7H)	

[CHART 11] BULK DUMP FORMAT (MULTI)

STATUS	11110000B	(F0H)	
IDENTIFICATION	01000011B	(43H)	
SUB STATUS	0000nnnnB	(0nH)	n = DEVICE NUMBER
FORMAT NUMBER	01111010B	(7AH)	
BYTE COUNT(MSB)	00000001B	(01H)	
BYTE COUNT(LSB)	00111010B	(3AH)	(Byte Count = 186)
	HEADER	26 byte	see (3-3-2) BULK DUMP
	MULTI HEADER	11 byte	see chart 1
	EFFECT	5 byte	see chart 5
	CH_0 VOICE	9 byte	see chart 1
	CH15 VOICE	9 byte	see chart 1
CHECK SUM	0eeeeeeeB	2's complement of 7 bits sum of all data bytes	
EOX	11110111B	(F7H)	

[CHART 12] BULK DUMP FORMAT (SYSTEM)

STATUS	11110000B	(F0H)	
IDENTIFICATION	01000011B	(43H)	
SUB STATUS	0000nnnnB	(0nH)	n = DEVICE NUMBER
FORMAT NUMBER	01111010B	(7AH)	
BYTE COUNT(MSB)	00000000B	(00H)	
BYTE COUNT(LSB)	00101010B	(2AH)	(Byte Count = 42)
	HEADER	26 byte	see (3-3-2) BULK DUMP
	SYSTEM	16 byte	see chart 8
CHECK SUM	0eeeeeeeB	2's complement of 7 bits sum of all data bytes	
EOX	11110111B	(F7H)	

SEQUENCER PART

(1) TRANSMIT FLOW

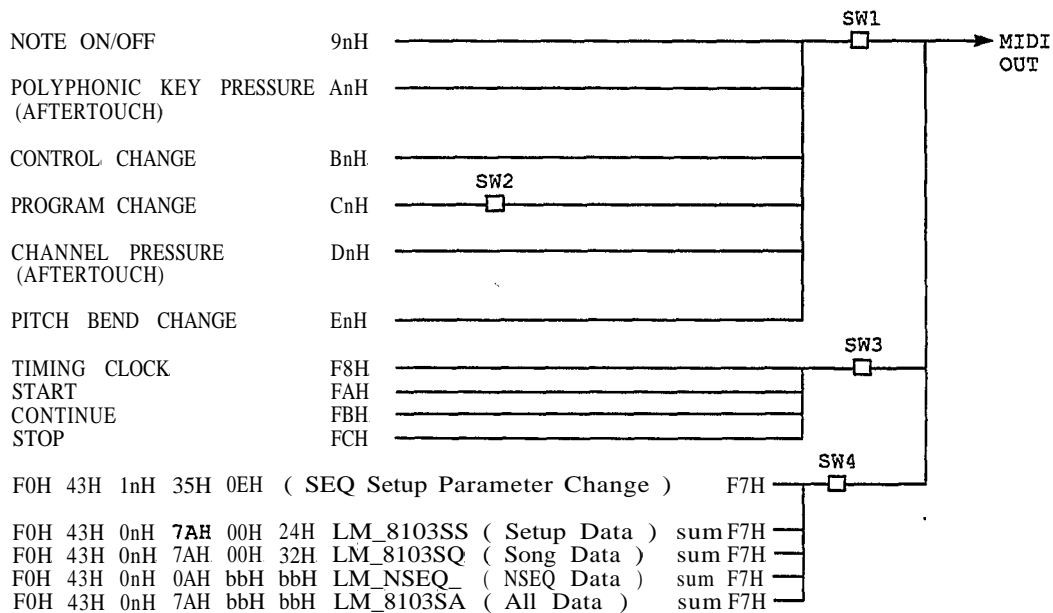

- SW1 MIDI Transmit Channel
Transmit channel selection for each track.
- SW2 Program Change Mode Select
Program change transmission ON/OFF, normal mode, or direct mode can be selected.
- SW3 MIDI Control
Transmit ON/OFF can be selected.
- SW4 System Exclusive Message Transmit Channel
System exclusive message transmission ON/OFF or device number can be selected.

(2) RECEIVE FLOW

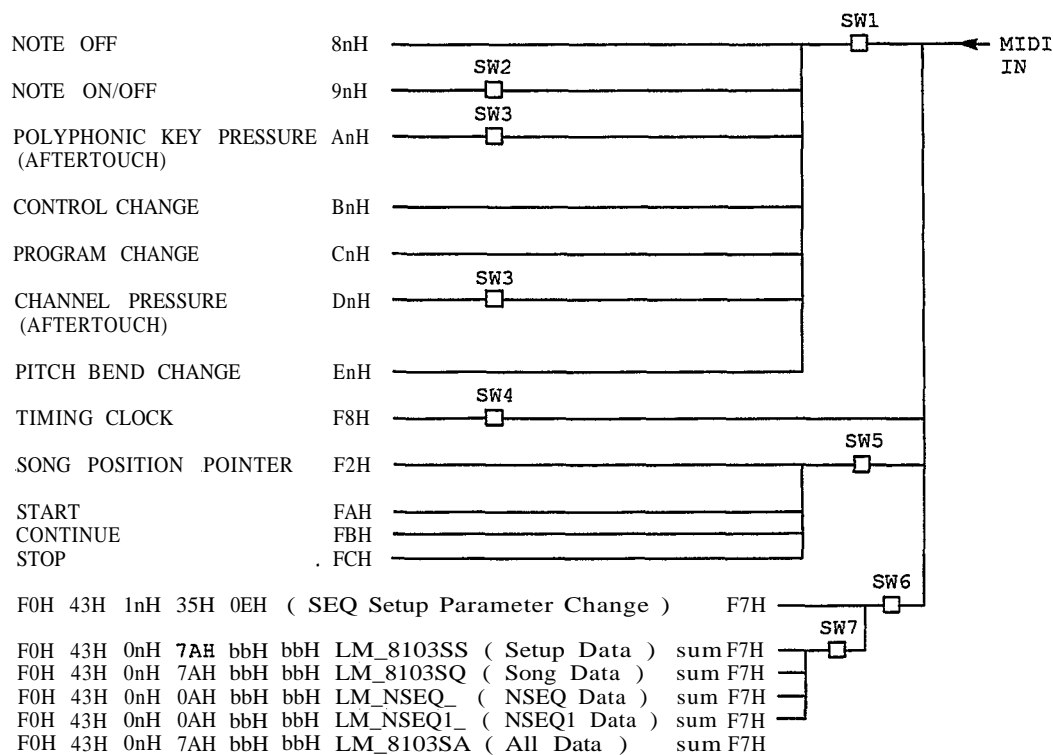

- SW1 MIDI Receive Channel
Record receive channel can be selected.
- SW2 Velocity Filter
Velocity recording ON/OFF can be selected.
- SW3 Aftertouch Filter
Aftertouch recording ON/OFF can be selected.
- SW4 Clock Condition Select
Internal timing clock, or external timing clock received via MIDI IN can be selected
- SW5 MIDI Control
Receive ON/OFF can be selected.
- SW6 System Exclusive Message Receive Channel
System exclusive message receive ON/OFF or device number can be selected.
- SW7 Bulk Protect
Bulk data receive ON/OFF can be selected.

(3) TRANSMIT/RECEIVE DATA

(3-1) CHANNEL VOICE MESSAGE

Transmitted during play or overdub.
Received during recording.

(3-1-1) NOTE OFF

STATUS	1000nnnnB	(8nH)	n = VOICE CHANNEL NUMBER
NOTE NUMBER	0kkkkkkkB		k = 0 (C-2) ~ 111 (D#7)
VELOCITY	0vvvvvvvB		Ignored

Receive only.
Changed to 9nH 00H for transmission.

(3-1-2) NOTE OH/OFF

STATUS	1001nnnnB	(9nH)	n = VOICE CHANNEL NUMBER
NOTE NUMBER	0kkkkkkkB		k = 0 (C-2) ~ 111 (D#7)
VELOCITY	0wwvvvB	(v0)	NOTE ON
	0000000B	(v0)	NOTE OFF

Velocity recording ON/OFF during reception can be selected.

(3-1-3) POLYPHONIC KEY PRESSURE (AFTERTOUC)

STATUS	1010nnnnB	(AnH)	n = VOICE CHANNEL NUMBER
NOTE NUMBER	0kkkkkkkB		k = 0 (C-2) ~ 111 (D#7)
PRESSURE VALUE	0vvvvvvvB		v = 0 ~ 127

Touch recording ON/OFF during reception can be selected.

(3-1-4) CONTROL CHANGE

STATUS	1011nnnnB	(BnH)	n = VOICE CHANNEL NUMBER
CONTROL NUMBER	0ccccccB		c = 0 ~ 120
CONTROL VALUE	0vvvvvvvB		

(3-1-5) PROGRAM CHANGE

[NORMAL MODE]

STATUS	1100nnnnB	(CnH)	n = VOICE CHANNEL NUMBER
PROGRAM NUMBER	0pppppppB		p = 0 ~ 118

[DIRECT MODE]

STATUS	1100nnnnB	(CnH)	n = VOICE CHANNEL NUMBER
MODE/MEMORY NUMBER	0ddddddB		d = 119 - 127
PROGRAM NUMBER	0pppppppB		p = 0 ~ 79

* MODE/MEMORY NUMBER

d = 119	INDIVIDUAL	INTERNAL	
d = 120	INDIVIDUAL	CARD	
	(INTERNAL and CARD cannot be combined in one MULTI.)		
d = 121	INDIVIDUAL	PRESET	
d = 122	COMMON	VOICE PLAY MODE	INTERNAL
d = 123	COMMON	VOICE PLAY MODE	CARD
d = 124	COMMON	VOICE PLAY MODE	PRESET
d = 125	COMMON	MULTI PLAY MODE	INTERNAL
d = 126	COMMON	MULTI PLAY MODE	CARD
d = 127	COMMON	MULTI PLAY MODE	PRESET

During transmission, program change transmission ON/OFF, normal mode, or direct mode can be selected (in UTILITY mode).

(3-1-6) CHANNEL PRESSURE / AFTERTOUC

STATUS	1101nnnnB	(DnH)	n = VOICE CHANNEL NUMBER
PRESSURE VALUE	0vvvwwB		v = 0 ~ 127

After touch recording ON/OFF during reception can be selected.

(3-1-7) PITCH BEND CHANGE

STATUS	1110nnnnB	(EnH)	n = VOICE CHANNEL NUMBER
LSB	0vvvwwB		PITCH BEND CHANGE LSB
MSB	0vvvwwB		PITCH BEND CHANGE MSB

(3-2) CHANNEL MODE MESSAGE

Not transmitted or received.

(3-3) SYSTEM COMMON MESSAGE

F2H (song position pointer) only received (except during record or play).
No others transmitted or received.

(3-3-1) SONG POSITION POINTER

STATUS	11110010B	(F2H)	
	01111111B		l = LEAST SIGNIFICANT
	0hhhhhhhB		h = MOST SIGNIFICANT

Receive only.
Receive ON/OFF selection.

(3-4) SYSTEM REAL TIME MESSAGE

(3-4-1) TIMING CLOCK

STATUS	11111000B	(F8H)
--------	-----------	-------

Internal timing clock, or external timing clock received via MIDI IN can be selected.

Transmit ON/OFF can be selected.

(3-4-2) START

STATUS	11111010B	(FAH)
--------	-----------	-------

Transmit/receive ON/OFF can be selected.

(3-4-3) CONTINUE

STATUS	11111011B	(FBH)
--------	-----------	-------

Transmit/receive ON/OFF can be selected.

(3-4-4) STOP

STATUS	11111100B	(FCH)
--------	-----------	-------

Transmit/receive ON/OFF can be selected.

(3-5) SYSTEM EXCLUSIVE MESSAGE

Exclusive messages not received in demo mode.

(3-5-1) PARAMETER CHANGE

STATUS	11110000B	(F0H)	
IDENTIFICATION	01000011B	(43H)	
SUB STATUS	0001nnnnB	(1nH)	n = DEVICE NUMBER
GROUP NUMBER	00010000B	(35H)	
STRUCTURE NUMBER MSB	00001110B	(0EH)	
STRUCTURE NUMBER LSB	00000000B	(00H)	
PARAMETER NUMBER MSB	00000000B	(00H)	
PARAMETER NUMBER LSB	0pppppppB		
PARAMETER VALUE MSB	00000000B	(00H)	
PARAMETER VALUE LSB	0vvvvvvvB		
EOX	11110111B	(F7H)	

Setup data only, parameter change transmitted and received.
Not received during play.

Device number and transmit/receive ON/OFF can be selected in UTILITY mode.

See chart 1 for PARAMETER NUMBER and VALUE.
Data Format same as sequencer section.

(3-5-2) BULK DUMP

(i) SETUP DATA, SONG DATA or ALL DATA

STATUS	11110000B	(F0H)	
IDENTIFICATION	01000011B	(43H)	
SUB STATUS	0000nnnnB	(0nH)	n = DEVICE NUMBER
FORMAT NUMBER	01111010B	(7AH)	
BYTE COUNT(MSB)	0bbbbbbbB		
BYTE COUNT(LSB)	0bbbbbbbB		
CLASSIFICATION	01001100B	(4CH)	ASCII'L
NAME	01001101B	(4DH)	ASCII'M
	00100000B	(20H)	ASCII'_
	00100000B	(20H)	ASCII'_
DATA FORMAT	00111000B	(38H)	ASCII'8
NAME	00110001B	(31H)	ASCII'1
	00110000B	(30H)	ASCII'0
	00110011B	(33H)	ASCII'3
	0mmmmmmmB		ASCII
	0mmmmmmmB		ASCII
ADDITIONAL	00000000B	(00H)	
HEADER	00000000B	(00H)	
	00000000B	(00H)	
	00000000B	(00H)	
	00000000B	(00H)	
	00000000B	(00H)	
	00000000B	(00H)	
	00000000B	(00H)	
	00000000B	(00H)	
	00000000B	(00H)	
	00000000B	(00H)	
	00000000B	(00H)	
	00000000B	(00H)	
	00000000B	(00H)	
	00000000B	(00H)	
	00000000B	(00H)	
MEMORY TYPE	0xxxxxxxB		
MEMORY NUMBER	0yyyyyyyB		
DATA	0dddddddB		
	0dddddddB		
CHECK SUM	0eeeeeeeB		2's complement of 7 bits sum of all data bytes
EOX	11110111B	(F7H)	

data bytes

Type	b	m	x	y	Refer to
SETUP DATA	00H-24H	SS	00H	00H	chart 2
SONG DATA	00H-32H	SQ	7FH	00H	chart 2
ALL DATA	bbH-bbH	SA	00H	00H	

note) Additional header ignored when received.

(ii) NSEQ DATA

STATUS	11110000B	(F0H)	
IDENTIFICATION	01000011B	(43H)	
SUB STATUS	0000nnnnB	(0nH)	n = DEVICE NUMBER
FORMAT NUMBER	00001010B	(0AH)	
BYTE COUNT(MSB)	0bbbbbbbB		
BYTE COUNT(LSB)	0bbbbbbbB		
CLASSIFICATION	01001100B	(4CH)	ASCII'L
NAME	01001101B	(4DH)	ASCII'M
	00100000B	(20H)	ASCII'_
	00100000B	(20H)	ASCII'_
DATA FORMAT	0mmmmmmB	(4EH)	ASCII'N
NAME	0mmmmmmB	(53H)	ASCII'S
	0mmmmmmB	(45H)	ASCII'E
	0mmmmmmB	(51H)	ASCII'Q
	0mmmmmmB		ASCII
	0mmmmmmB	(20H)	ASCII'_
DATA	0dddddddB		data bytes
	0dddddddB		
CHECK SUM	0eeeeeeeB	2's complement of 7 bits sum of all data bytes	
EOX	11110111B	(F7H)	

Type	m	Refer to
NSEQ DATA	NSEQ_	chart 3
NSEQ1 DATA (receive only)	NSEQ1_	

The five types of data shown in (i) and (ii) are transmitted. Device number, transmit/receive ON/OFF and protect can be selected in UTILITY mode.

Reception possible only in modes other than play and record. "LM_NSEQ1_" bulk header can also be received (however, macro, odd time signatures, and exclusive data will be ignored).

When song data or NSEQ data is received, the data is loaded into that song only when that song is empty.

When all data is received, the received data is loaded and all previous data is erased.

Transmitted when UTILITY mode Bulk Transmit executed.

The following data is transmitted when "SETUP" is selected and a bulk dump is executed.

1. SETUP DATA

The following data is transmitted when "SONG" is selected, a song number is selected, and a bulk dump is executed.

1. SONG DATA
2. NSEQ DATA

No transmission occurs if the specified song is empty.

The "ALL DATA" data format is as shown below when "SEQ ALL" is selected and a bulk dump is executed.

1. SONG 1 SONG DATA
- .
8. SONG 8 SONG DATA
9. SETUP DATA
10. SONG 1 NSEQ DATA
- .
17. SONG 8 NSEQ DATA

The song data is transmitted even if the song is empty.
 NSEQ track data begins with F0H mnH (m = song number; n = track number)

If bulk dumps are executed in succession, a break of greater than 100 milliseconds is inserted between each transmission.
 If an ALL DATA or NSEQ DATA transmission exceeds 512 bytes, it will be broken down into 512-byte blocks and a byte count and header will be attached to the beginning of each. A checksum will be attached to the end of each block. A break of greater than 100 milliseconds will be inserted between each block.
 In accordance with the above, a break of greater than 100 milliseconds is required between each bulk dump when multiple bulk dumps are received.

(3-5-3) DUMP REQUEST

Not receive.

[CHART 1] SEQUENCER SETUP DATA

MIDI Parameter Change Format

F0H 43H 1nH 35H 0EH 00H 00H n2H 00H v2H F7H

note) n ; device number
 n2 ; parameter number
 v2 ; parameter value

No.	function	value	note
0	Click Condition	0-3	0: off, 1:rec, 2:play/rec, 3:always
1	Clock Condition	0-1	0: internal, 1:MIDI
2	Rec Channel	0-17	0-15:1-16ch, 16:omni, 17:kbd
3	After Touch Record SW	0-1	0:off, 1:on
4	Velocity Record SW	0-1	0:off, 1:on
5	Song Number	0-7	0-7:1-8
6	Rec Type	0-3	0:overdub, 1:replace, 2:step, 3:punch
7	MIDI Control	0-1	0:off, 1:on
8	Reserve	0	
9	Reserve	0	

[CHART 2] SEQUENCER SONG DATA

No.	function	value	note
0	Time Signature 1	0-15	TSIG1/TSIG2 TSIG1=0:1..15:16 TSIG2=2:1/4, 3:1/8, 4:1/16
1	Time Signature 2	2-4	
2	Tempo 1	0-1	tempo 30-240
3	Tempo 2	0-127	
4	Song Name 1	20-127	
5	Song Name 2	20-127	
6	Song Name 3	20-127	
7	Song Name 4	20-127	
8	Song Name 5	20-127	
9	Song Name 6	20-127	
10	Song Name 7	20-127	
11	Song Name 8	20-127	
12	Track 1 Tch	0-15	
13	Track 2 Tch	0-15	
14	Track 3 Tch	0-15	

No.	function	value	note
15	Track 4 Tch	0-15	
16	Track 5 Tch	0-15	
17	Track 6 Tch	0-15	
18	Track 7 Tch	0-15	
19	Track 8 Tch	0-15	
20	Mode/Memory Number	122-127	Direct Mode Program Change
21	Program Number	0-79	
22	Reserved	0	
23	Song Data Store Flag	0-1	

[CHART 3] NSEQ DATA FORMAT

The NSEQ data for 1 song is composed of the data for several tracks beginning with FOH 0nH (n = track number) and ending with F2H. Track data not transmitted if the track is empty.

The time/event/control data described elsewhere is included between FOH, 0nH and F2H.

hex	description
F0 00	top of track #1
-- -- F2	time/event/control data end of record
-- -- --	track #2 ~ #7 data
F0 07	top of track #8
-- -- -- F2	time/event/control data end of record

(Add) NSEQ time/event/control data DATA FORMAT (binary)

short time	Ottttttt	(384th note/bit)
long time	Ottttttt Ottttttt	(MS byte = head of LS byte)
short note	10dddddd 0kkkkkkk 0vvvvvv	
long note	11dddddd 0ddddddd 0kkkkkkk 0vvvvvvv	
short note	10dddddd 1kkkkkkk	(When velocity = 40H)
long note	110dddddd 0ddddddd 1kkkkkkk	(When velocity = 40H)
	ddd = duration	(96th note/bit)
	kkk = MIDI note number	
	vvv = MIDI velocity	
measure mark	11110101	(Measure line)
no operation	11111000	

Others are the same as MIDI format except MS byte

poly a.touch	11111010 0kkkkkkk 0vvvvvv
control change	11111011 0ccccccc 0vvvvvv
program change	11111100 0ppppppp
channel a.touch	11111101 0vvvvvvv
pitch bend	11111110 0vvvvvvv 0vvvvvvv

Function . . .	Transmitted	Recognized	Remarks
Basic Default	1 - 16	1 - 16	memorized
Channel Changed	1 - 16	1 - 16	
Mode Default	3	1, 3	memorized
Mode Messages	x	x	
Mode Altered	*****	x	
Note Number : True voice	36 - 96 *****	0 - 127 0 - 127	
Velocity Note ON	<input type="radio"/> 9nH, v=1-127	<input type="radio"/> v=1-127	
Velocity Note OFF	<input checked="" type="radio"/> 9nH, v=0	<input checked="" type="radio"/> x	
After Key's	<input checked="" type="radio"/> x	<input checked="" type="radio"/> x	
Touch Ch's	<input type="radio"/> o	<input type="radio"/> o	
Pitch Bender	<input type="radio"/> o	<input type="radio"/> o 0-12 semi	17 bit resolution
Control Change	0 <input checked="" type="radio"/> x 1 <input type="radio"/> o 2 <input type="radio"/> o 3-5 <input checked="" type="radio"/> x 6 <input type="radio"/> o (play mode) 7 <input type="radio"/> o 8-63 <input checked="" type="radio"/> x 64 <input type="radio"/> o 65-120 <input checked="" type="radio"/> x	<input type="radio"/> o <input type="radio"/> o <input type="radio"/> o <input type="radio"/> o <input type="radio"/> o <input type="radio"/> o <input type="radio"/> o	Modulation Wheel Breath Control Data Entry Knob Volume Sustain Switch
Prog Change : True #	<input type="radio"/> o 0-79, 119-127 *****	<input type="radio"/> o 0-79, 119-127 0 - 63	if program on
System Exclusive	<input type="radio"/> o	<input type="radio"/> o	voic, mult, system
System : Song Pos	<input checked="" type="radio"/> x	<input checked="" type="radio"/> x	
System : Song Sel	<input checked="" type="radio"/> x	<input checked="" type="radio"/> x	
Common : Tune	<input checked="" type="radio"/> x	<input checked="" type="radio"/> x	
System : Clock	<input checked="" type="radio"/> x	<input checked="" type="radio"/> x	
Real Time : Commands	<input checked="" type="radio"/> x	<input checked="" type="radio"/> x	
Aux : Local ON/OFF	<input checked="" type="radio"/> x	<input checked="" type="radio"/> x	
Aux : All Notes OFF	<input checked="" type="radio"/> x	<input checked="" type="radio"/> x	
Mes- : Active Sense	<input type="radio"/> o	<input type="radio"/> o	
sages: Reset	<input checked="" type="radio"/> x	<input checked="" type="radio"/> x	
Notes:			

Function . . .	Transmitted	Recognized	Remarks
Basic Default	1 - 16	1 - 16	memorized
Channel Changed	1 - 16	1 - 16	
Mode Default	x	x	
Mode Messages	x	x	
Mode Altered	*****	x	
Note Number : True voice	0 - 111 *****	0 - 111	
Velocity Note ON	o 9nH,v=1-127	o v=1-127	*1
Velocity Note OFF	x 9nH,v=0	x	
After Key's	o	o (after on)	
Touch Ch's	o	o (after on)	
Pitch Bender	o	o	
Control Change	0 - 120 o	o	
Prog Change : True #	o 0 - 127 *****	o 0 - 127	if program on
System Exclusive	o	o	setup, song, seq
System : Song Pos	x	o (MIDI cont on)	
System : Song Sel	x	x	
Common : Tune	x	x	
System : Clock-Real Time : Commands	o (MIDI cont on)	o (MIDI sync)	
Aux : Local ON/OFF	x	x	
Aux : All Notes OFF	x	x	
Mes- : Active Sense	x	x	
sages: Reset	x	x	
Notes: *1 = receive if velocity record switch is on. if switch is off, velocity is fixed to 64.			

Mode 1 : OMNI ON, POLY Mode 2 : OMNI ON, MONO o : Yes
 Mode 3 : OMNI OFF, POLY Mode 4 : OMNI OFF, MONO x : No

YAMAHA

YAMAHA®

Yamaha Corporation of America
6600 Orangethorpe Avenue, P.O. Box 6600, Buena Park, CA 90622-6600

SY55 OM

7/22/98 29313

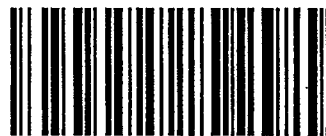

SY55 OM



Recyclable



Recycled