

KORG

Z1

MOSS

Multi Oscillator Synthesis System

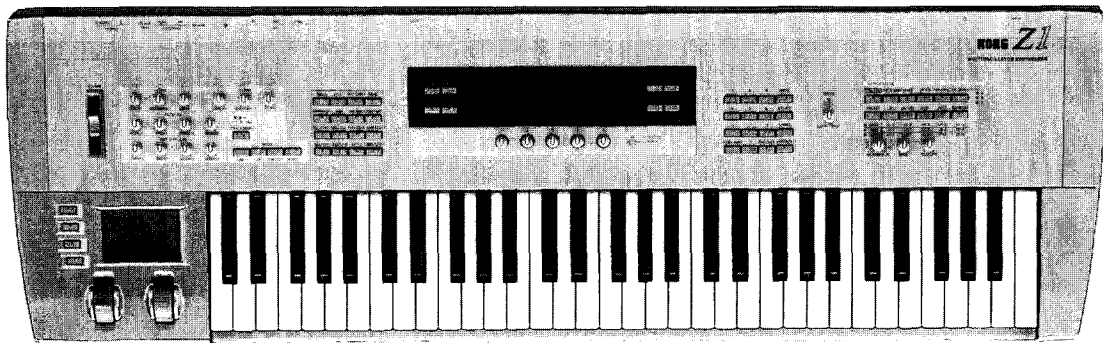

Owner's Manual

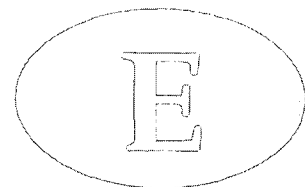

Introduction

Thank you for purchasing the Korg Z1 Multi Oscillator Synthesizer. In order to enjoy long and trouble free use, please read this manual carefully and use the instrument correctly.

IMPORTANT SAFETY INSTRUCTIONS

WARNING — When using electrical products, basic precautions should be followed, including the following:

1. Read all the instructions before using the product.
2. Do not use this product near water — for example, near a bathtub, sink, in a wet basement, or near a swimming pool, etc.
3. This product should be used only with additional hardware that is recommended by the manufacturer.
4. This product, either alone or in combination with an amplifier and headphones or speakers, may be capable of producing sound levels that could cause permanent hearing loss. Do not operate for a long period of time at a high volume level or at a level that is uncomfortable. If you experience any hearing loss or ringing in the ears, you should consult an audiologist.
5. The product should be located so that its location or position does not interfere with its proper ventilation.
6. The product should be located away from heat sources such as radiators, heat registers, or other products that produce heat.
7. The product should be connected to a power supply of the type described in the operating instructions or as marked on the product.
8. The power-supply cord of the product should be unplugged from the outlet when left unused for a long period of time.
9. Care should be taken so that objects do not fall and liquids are not spilled into the enclosure through openings.
10. The product should be serviced by qualified personnel when:
 - A. The power-supply cord or the plug has been damaged; or
 - B. Objects have fallen, or liquid has been spilled into the product; or
 - C. The product has been exposed to rain; or
 - D. The product does not appear to operate normally or exhibits a marked change in performance; or
 - E. The product has been dropped, or the enclosure damaged.
11. Do not attempt to service the product beyond that described in the user-maintenance instructions. All other servicing should be referred to qualified service personnel.

SAVE THESE INSTRUCTIONS

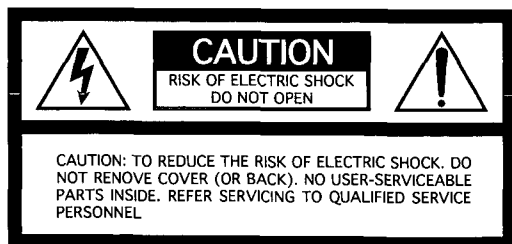

The lightning flash with the arrowhead symbol within an equilateral triangle, is intended to alert the user to the presence of uninsulated "dangerous voltage" within the product's enclosure that may be of sufficient magnitude to constitute a risk of electric shock to people.



The exclamation point within an equilateral triangle is intended to alert the user to the presence of important operating and maintenance (servicing) instructions in the literature accompanying the product.

GROUNDING INSTRUCTIONS

This product must be grounded (earthed). If it should malfunction or breakdown, grounding provides a path of least resistance

for electric current to reduce the risk of electric shock. This product is equipped with a cord having an equipment-grounding conductor and a grounding plug. The plug must be plugged into an appropriate outlet that is properly installed and grounded in accordance with the local codes and ordinances.

DANGER — Improper connection of the equipment-grounding conductor can result in a risk of electric shock. Check with a qualified electrician or serviceman if you are in doubt as to whether the product is properly grounded. Do not modify the plug provided with the product — if it will not fit the outlet, have a proper outlet installed by a qualified electrician.

THE FCC REGULATION WARNING

This equipment has been tested and found to comply with the limits for a Class B digital device, pursuant to Part 15 of the FCC Rules. These limits are designed to provide reasonable protection against harmful interference in a residential installation. This equipment generates, uses, and can radiate radio frequency energy and, if not installed and used in accordance with the instructions, may cause harmful interference to radio communications. However, there is no guarantee that interference will not occur in a particular installation. If this equipment does cause harmful interference to radio or television reception, which can be determined by turning the equipment off and on, the user is encouraged to try to correct the interference by one or more of the following measures:

- Reorient or relocate the receiving antenna.
 - Increase the separation between the equipment and receiver.
 - Connect the equipment into an outlet on a circuit different from that to which the receiver is connected.
 - Consult the dealer or an experienced radio/TV technician for help.
- Unauthorized changes or modification to this system can void the user's authority to operate this equipment.

CE mark for European Harmonized Standards

CE mark which is attached to our company's products of AC mains operated apparatus until December 31, 1996 means it conforms to EMC Directive (89/336/EEC) and CE mark Directive (93/68/EEC).

And, CE mark which is attached after January 1, 1997 means it conforms to EMC Directive (89/336/EEC), CE mark Directive (93/68/EEC) and Low Voltage Directive (73/23/EEC). Also, CE mark which is attached to our company's products of Battery operated apparatus means it conforms to EMC Directive (89/336/EEC) and CE mark Directive (93/68/EEC).

IMPORTANT NOTICE FOR THE UNITED KINGDOM

Warning—THIS APPARATUS MUST BE EARTHED

As the colours of the wires in the mains lead of this apparatus may not correspond with the coloured markings identifying the terminals in your plug, proceed as follows:

- the wire which is coloured green and yellow must be connected to the terminal in the plug which is marked with the letter E or by the earth symbol \oplus , or coloured green or green and yellow.
- the wire which is coloured blue must be connected to the terminal which is marked with the letter N or coloured black.
- the wire which is coloured brown must be connected to the terminal which is marked with the letter L or coloured red.

ADAT and Alesis are registered trademarks of Alesis Corporation.

ADAT Digital Interface is a trademark of Alesis Corporation.

About the Z1's backup battery

The Z1 contains a backup battery which prevents memory from being lost when the power is turned off. When an indication of "Internal battery is LOW" appears in the display, the battery must be replaced. Please contact a nearby service center or dealer.

About data

If for some reason a malfunction occurs, there may be cases in which the contents of memory will be lost, so be sure to save important data on an external data filing device. Korg can accept no responsibility for any damages, direct or otherwise, that may occur as a result of loss of data.

How this owner's manual is organized

This owner's manual is organized as follows.

Introduction

This section explains basic handling of the Z1, introduces its overall functionality, and explains the front and rear panels.

Quick-start guide (Basic Operation/Performance Editing, Editing)

If you wish to immediately begin playing and editing, read this chapter first.

The first section, "Basic Operation/Performance Editing," explains how to select a Program or MultiSet on the Z1, how to use the controllers and editor, and other basic performance techniques using the arpeggiator.

The second section, "Editing," explains the basic procedure for creating sounds, and introduces you to basic editing.

Editing parameter guide

This section explains all editing parameters of the Z1, organized by mode (or section). If you wish to learn more about the function of a specific parameter, you can use this part of the manual like a dictionary.

Appendices

This section contains various information such as the MIDI functionality of the Z1, utility functions, options, specifications, and error messages.

Conventions in this owner's manual

Switches and knobs etc. []

Switches and knobs on the Z1's front panel are printed in square brackets [].

Parameters appearing in the LCD

Parameters which are displayed in the LCD are printed in double quotation marks " ". Parameter values are printed in bold characters.

Caution mark

This points out related parameters or information pertaining to the marked item.

Procedure ① ② ③ ...

Steps in a procedure are indicated as ① ② ③ ...

(see p.XX)

This indicates a page in the manual with related information.

The Editing Parameter Guide (pages 29 to) is formatted as follows.

Title of the mode or section, etc.

5. EG section

Explanation of the mode or section

This section provides four general purpose EGs (envelope generators). The four EGs can be used as modulation sources for the parameters of other sections to create time-variant change in the sound.

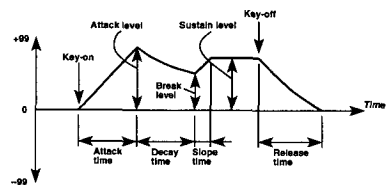

Page title

EG1 page

Line	Column	Parameter Name	Value
1	1	Env1:60	60
2	2	Stal-62	62
3	3	Level 1	00
4	4	Time	00
5	5	00**OFF**00	00

Parameter heading

Line

Column

Line	Column	Parameter Name	Value
1	1	Settings for the general-purpose EGs	
2	1	2-1 Start Level	[-99...+99]
3	1	1-2 Attack Time	[0...99]
4	1	2-2 Attack Level	[-99...+99]

Parameter of name

Explanation of parameter

Parameter setting range



Program names etc. that appear in this manual are provisional, and may not necessarily be the same as what you see in the LCD of your Z1.

Contents

Introduction ii

Important safety instructions	ii
About the Z1's backup battery	iii
About data	iii
How this owner's manual is organized	iii
Conventions in this owner's manual	iii

Overview of the Z1viii

Main features	viii
About the Z1's modes	viii
Program Play mode	viii
MultiSet Play mode	viii
Program Edit mode	ix
MultiSet Edit mode	ix
Arpeggio mode	ix
MIDI mode	ix
Global mode	ix
Upgrading with optional boards	ix

Front and rear panel x

Front panel	x
Rear panel	xii

Connections xiii

1. Connecting the power cable	xiii
2. Connecting audio equipment	xiii
3. Connecting pedals, etc.	xiii
4. Connections with MIDI equipment	xiii

Quick-start Guide 1

Basic Operation and Performance Editing 2

1. Check the connections	2
2. Turning the power on/off	2
Turning the power on	2
Turning the power off	2
3. Adjusting the volume	2
4. Listen to the demo songs	2
5. Playing a program	3
Select Program Play mode	3
Select a program bank	3
Select a program number	3
Selecting programs of the same category	3
Selecting programs of the same user group	4
Selecting programs by category or user group	4
Other ways to select programs	4
Selecting programs from a card	4
6. Playing a MultiSet	5

Select MultiSet Play mode	5
Select the MultiSet bank	5
Select the MultiSet number	5
Other ways to select a MultiSet	5
Selecting MultiSets from a card	5
7. Using various controllers to modify the sound ...	6
Using the [X-Y] pad	6
Using the [X-Y HOLD] function	6
Using the [PORTAMENTO] control	6
Using the [SW1] and [SW2] keys	6
Using the [PITCH BENDER]	6
Using the [MOD WHEEL]	6
Using the keyboard	6
Using controllers connected to the rear panel <Optional>	6
How to assign sound-modifying functions to a controller	7
8. Using the realtime editor to modify the sound	7
Modifying the cutoff frequency to vary the brightness of the sound	7
Modifying the resonance to give character to the sound	7
Causing the brightness to vary over time	7
Causing the volume to vary over time	8
Mute an oscillator to modify the sound	8
Saving a sound that you modified using the realtime editor	8
9. Using the performance editor to modify the sound	9
Using the performance editor to control the sound	9
Saving a sound that you modified using the perfor- mance editor	9
10. Using the arpeggiator	10
Turning on the arpeggiator	10
Adjusting the arpeggiator tempo	10
Changing the base timing of the arpeggiated notes ..	10
Selecting the arpeggio bank	10
Selecting the arpeggio pattern	10
Selecting arpeggio patterns from a card	10
Playing keyboard notes together with arpeggio notes	10
Causing the arpeggio to continue playing after you release the notes	10
Causing the arpeggio to play through multiple octaves	11
Applying key-sync to the arpeggiator	11
Changing the length of the arpeggiated notes	11
Changing the loudness of the arpeggiated notes	11
Saving the arpeggiator on/off settings etc.	11
Linking the arpeggiator to a program or MultiSet	11

Editing 12

1. Restoring the factory settings	12
2. About the edit mode display	12
3. Basic editing procedure	13
Select a mode (and section)	13
Select a page	13
Moving the cursor	13
Inputting values	14

Saving the modified settings	14
4. Program editing (Program Edit mode)	15
How a Program is organized	15
Filter settings (Filter section)	16
Amp settings (AMP section)	17
Effect settings (Prog Fx section)	17
Oscillator settings (OSC section)	18
Adjusting the volume of each oscillator (Prog Mixer section)	19
About keyboard tracking	19
EG and LFO (EG/LFO section)	19
Modulation sources and intensity	19
Performance editor assignments	20
5. Editing a MultiSet (MultiSet Edit mode)	21
How a MultiSet is organized	21
Selecting the Timbre Programs	21
Adjusting the volume, pan, and effect amount	22
Specifying the way in which different keyboard areas or playing strengths will be sounded	22
Effect settings	22
Restricting the controllers or editor for each timbre ...	22
Editing other MultiSet parameters	22
6. Arpeggio editing (Arpeggio mode)	23
Creating a user pattern	23
Arpeggiator settings in MultiSet	24
7. Saving data	25
About the edit buffer	25
Memory protect	25
Modifying a name (Rename)	25
Specifying the category and user group	26
The Write procedure	26
8. Convenient editing functions	27
UNDO function	27
COMPARE function	27
UTILITY functions	27

Parameter Editing Guide... 29

Editing a program (Program Edit mode) 30

1. OSC section 30

OSC Set Up page	30
Select the Oscillator Type	30
Modifying the oscillator pitch over time (Common Pitch Mod.)	30
Specify the way in which Portamento is applied (Portamento)	30
Specify the width of pitch bender control (Pitch Bend)	31
OSC1 page	31
Specify the basic pitch of oscillator 1 (Pitch)	31
Modulate the pitch (Pitch Modulation)	31
Specify how pitch will change in relation to the keyboard (key)	32
OSC2 page	32

Settings specific to each oscillator type	32
•Standard OSC	32
•COMB Filter OSC	34
•VPM OSC	36
•Resonance OSC	37
•Ring Modulation OSC	39
•Cross Modulation OSC	39
•Sync Modulation OSC	40
•Organ Model	40
•Electric Piano Model	41
•Brass Model	42
•Reed Model	44
•Plucked String Model	45
•Bowed String Model	48
Sub Oscillator page	50
•Sub Oscillator	50
Specifying the waveform of the sub oscillator	50
Specifying the basic pitch of the sub oscillator	50
Modifying the pitch of the sub oscillator (Pitch Modulation)	50
Specifying how the pitch of the sub oscillator will correspond to the note of the keyboard (Pitch Slope)	50
Noise Generator page	50
•Noise Generator	50
Noise generator settings	50
2. Prog Mixer section 51	
Mix Level page	51
Adjusting the levels that are sent to Mixer Outputs 1/2	51
Mix Mod. page	51
Specify the modulation source and intensity that will control each output level	51
3. Filter section 52	
Filter Routing page	52
Specify the filter routing	52
Filter 1 page	53
Specify the type and cutoff frequency of filter 1 (Filter 1)	53
Using Resonance to add character to the sound	53
Filter 1 Fc Kbd page	54
Specify how the brightness will be affected by keyboard position (Cutoff Keyboard Track)	54
Filter B settings when 2BPF is selected	54
Filter 2 / Filter 2 Fc Kbd pages	54
4. AMP (Amplifier) section 55	
Amplitude page	55
Specify the volume level of amp 1 (Amp 1)	55
Control the volume level of amp 1 (Amplitude Modulation)	55
Specify how volume will be affected by keyboard position (Amp Keyboard Track)	55
Settings for amp 2 (Amp 2)	55
Specify the output level (Output)	55
Specify the stereo location (Panpot)	55

Amp EG page	55	•Stereo Delay	74
Amp EG settings (Amp EG)	55	•Reverb-Hall	74
5. EG section	57	•Reverb-Room	75
EG1 page	57	Mst.EQ page	76
Settings for the general-purpose EGs	57	Make settings for the Mst.EQ	76
EG2 / EG3 / EG4 pages	57	•Master EQ	76
6. LFO section	58	Editing a Multiset	(MultiSet Edit mode)
LFO1 page	58		77
Settings for the general-purpose LFOs	58	1. Multi Timbre section	77
7. Prog Fx section	59	Specify the maximum polyphony for each timbre	77
Effect Set Up page	59	Specify the program for each timbre	77
Specify the output level to the effects	59	2. Multi Mixer section	77
Select the effect type for Fx1	59	Specify the volume of each timbre	77
Select the effect type for Fx2	59	Specify the panpot of each timbre	77
Select the effect type for M.Fx	60	Specify the output level of each timbre to the	effects
Adjusting the gain of the M.EQ	60		77
8. Prog Common section	60	3. Multi Zone section	78
CMN Voice page	60	Selecting the timbre for which you wish to make	note range or velocity range settings
Specifying how the notes played will be sounded	60	Specify the range of notes for which the timbre	will sound
Select the scale type	61	Specify the range of velocities for which the timbre	will sound
Specify the category and user group	61		78
CMN SW & Pedal page	62	4. Multi Pitch section	78
Specifying the function of [SW1] and [SW2]	62	Transpose each timbre	78
Specify the function of each pedal	62	Make fine adjustments to the pitch of each timbre ...	78
CMN Mod. Src List page	62	Specify the scale for each timbre	78
View and edit all modulation sources simul	taneously	5. Multi MIDI & Arpeggio section	79
	62	Specify the MIDI channel of each timbre	79
CMN PE Define page	63	Specify whether or not MIDI program change	messages will be received by each timbre
Specify the operation of the Performance Editor	63	Specify the timbres that will be played by the	arpeggiator
CMN Program Name page view	63		79
Modifying the name of a program	63	6. Multi Control Filter section	80
Effect types	64	MLT Ctl Fltr P1 page	80
Fx1 page	64	Specify how each timbre will respond to MIDI	messages
Specify the effect which Fx1 will use	64	MLT Ctl Fltr P2 page	80
•Overdrive	64	7. Multi Fx section	81
•Compressor	64	MLT Effect Set Up page (Multi Fx)	81
•Parametric EQ	65	Select the effect type for Fx1	81
•Wah	66	Select the effect type for Fx2	81
•Exciter	67	Select the effect type for M.Fx	81
•Decimator	67	Specify the gain of the Mst.EQ	81
•Chorus	68	8. Multi Common section	82
•Flanger	68	MLT CMN Scale page	82
•Phaser	69	Specify the pitch bend width for the MultiSet	82
•Rotary Speaker (Small)	70	Specify the scale for the MultiSet	82
•Delay (Mono)	70	MLT CMN SW & Pdl page	82
•Talking Modulator	71	Specify the function of [SW1] and [SW2] for the	MultiSet
•Multitap Delay	71	Specify the function of each pedal for the MultiSet ..	82
•Ensemble	72		
•Rotary Speaker (Large)	73		
Fx2 page	74		
Specify the effect that Fx2 will use	74		
Mst.Fx page	74		
Specify the effect that Mst.Fx will use	74		

MLT CMN Name page	82
Modify the name of the MultiSet	82

Editing an arpeggio pattern (Arpeggio mode) 83

PAT Basic page	83
Specify the basic operation of the pattern	83
PAT User Type.....	83
PAT Step Param page	84
Specify the Step Tone	84
Specify parameters for each Step	84
PAT Pattern Name page	85
Modifying the name of an arpeggio pattern	85

MIDI-related settings (MIDI mode) ... 86

MIDI Basic page	86
Specify the Global MIDI channel	86
Local on/off setting	86
Omni on/off setting	86
Synchronizing the Z1 and an external MIDI device	86
Using MIDI Program Change messages to select sounds	87
Specifying the bank on which sound selections (program or MultiSet) will be transmitted/received ..	87
MIDI Prog Map page	87
Specify the program change numbers that will be transmitted/received in Program Play mode	87
MIDI Multi Map page	87
Specify the program change numbers that will be transmitted/received in MultiSet Play mode	87
MIDI CChg Filter page	87
Controlling MIDI messages	87
MIDI System EX page	88
Transmitting MIDI system exclusive messages	88
Using data dump to save data on an external MIDI device <Data Dump Utility>	88
Receiving MIDI system exclusive messages	89

Settings that affect the entire Z1 (Global mode) 90

GLB Basic page.....	90
Adjust the tuning and transposition	90
Specify how transpose, velocity curve and aftertouch curve will be applied	90
Specify the velocity curve	90
Specify the aftertouch curve and sensitivity	91
Specify the polarity of the pedals connected to the rear panel	91
Prohibit writing of internal programs and arpeggio patterns	91
Using the page memory function	91
Selecting the area of a memory card	91
GLB User Group Name view page	92
Modifying the name of each user group	92
GLB User Scale page	92
Creating an original scale	92

GLB Ctrl SetUp page	93
Changing the volume pedal function to an expression pedal	93
Synchronizing with digital audio devices	93
Calibrating the various controllers	93
Linking the arpeggiator to programs or MultiSets....	94
Bypassing the master effect	94
The output configuration from stereo to mono	94
GLB Data Utility page	94
Loading data from a memory card	94
Loading the factory preset data into internal memory	95
Saving internal memory data to a memory card	95

Appendices 97

1. About MIDI	97
Connections between MIDI devices	97
MIDI channel settings	97
Using the Z1 as a MIDI keyboard for input	97
About the Transpose and Velocity Curve settings....	98
MIDI filtering and message conversion	98
Selecting sounds (programs or MultiSets)	98
MIDI messages which the Z1 transmits	98
Transmitting settings such as sound data (About data dump)	102
Editing sounds etc.	102
Using MIDI to control an LFO	102
About the Performance Editor	102
Controlling the arpeggiator	102
2. MIDI implementation chart	103
3. Mod. Source List	104
4. Utility list	105
Program Play mode	105
Program Edit mode	105
MultiSet Play mode	106
MultiSet Edit mode	106
Arpeggio mode	106
MIDI mode	106
Global mode	106
5. PE (Performance Editor) list	107
6. About the optional <DI-TRI digital I/F board>	109
DIGITAL OUT connector	109
WORD CLOCK IN connector	109
Example connections	109
7. About the optional <DSPB-Z1 option board> ..	109
8. About the Memory Card	110
Memory cards that can be used with the Z1	110
Memory card handling	110
Formatting a memory card	110
Saving data to a memory card	110
Reading data from a memory card	110
9. Troubleshooting	110
10. Error messages	111
11. Other messages	111
12. Specifications	112
Options	112
13. Index	113

Overview of the Z1

Main features

The Z1 is a 61 key polyphonic synthesizer with a MOSS (Multi-Oscillator Synthesis System) tone generator. It offers 12 voices of polyphony.

Broadly speaking, the Z1's MOSS (Multi-Oscillator Synthesis System) tone generator consists of the following sections: voice, EG/LFO, effect, and controllers.

In the voice section, there is an OSC section with two oscillators (1 and 2) that can use 13 types of oscillator algorithm (standard, ring modulation, VPM resonance, organ model, electric piano model, etc.), a sub-oscillator and a noise generator. The voice section also contains two filters, each of which can be used as one of five filter types, and including a dual band-pass filter that allows two center frequencies to be specified. This allows you to create human voice sounds or body resonances such as those characteristic to a violin or guitar.

This voice section can be modulated using five EGs and four LFOs to produce rich variation in the pitch, tone, and volume of each voice.

Two effects are also provided, each of which allows you to select one of 15 effect types, including multi-tapped delay, overdrive, and rotary speaker. In addition, there is a master effect that creates a spatial effect such as reverb or delay. The effect section also contains a two-band EQ that lets you put the finishing touch on your sound.

The Z1 gives you realtime control over all of this synthesis power. You have a modulation wheel, X-Y pad, a realtime editor section that lets you control parameters such as filter cutoff, resonance, filter EG and amp EG in the same way as on an analog synthesizer, five performance editor controls to which parameters can be freely assigned, and a rich variety of controllers including foot switch/volume pedal controllers. All of this means that you have realtime control of virtually any aspect of the sound including the effects. In addition, this functionality is MIDI-compatible, and the LFO allows MIDI synchronization.

The built-in polyphonic arpeggiator provides not only standard preset patterns such as up, down, ALT1, ALT2 and random, but also allows the user to freely create 15 original patterns for even greater possibilities.

This rich array of functionality can be controlled via a large, easy to view LCD.

A PCMCIA flash card slot expands the memory by up to 16 banks of data when a 4 Mbyte memory card is used. The Z1 supports both ATA specification Flash ROM and Device Type: Flash ROM card formats.

About the Z1's modes

The Z1 has the following seven modes.

□ Program Play mode

This mode allows you to play Programs.

A "program" is a single sound produced by the MOSS (Multi-Oscillator Synthesis System) tone generator.

The Z1 has 256 internal (built-in) programs, and these are grouped into two banks with 128 programs in each bank. A memory card (sold separately) can also be used and adds 256 Programs per bank.

Internal: A000 to A127 / B000 to B127

When a card is inserted: CARD A000 to Card A127 / CARD B000 to Card B127 (256 Programs) × 16 (4096 Programs when a 4 Mbyte memory cards is used)

For the factory setting programs and the sounds within each MultiSet (discussed below), refer to the "Voice Name List."

In Program Play mode you can select and play individual programs. In addition to controlling the sounds from the keyboard, you can also use the Z1's various controllers or the editor to modify the sound.

Arpeggiator function

Internal memory contains 5 preset patterns, and 15 user patterns. When a memory card (sold separately) is used, this can be increased by an additional 5 preset patterns and 15 user patterns per bank. The arpeggiator can be used in any mode.

Internal: PRESET_UP • DOWN • ALTERNATE 1 • ALTERNATE 2 • RANDOM, U1-1 to U1-5, U2-1 to U2-5, U3-1 to U3-5

When a card is inserted: CARD PRESET_UP • DOWN • ALTERNATE 1 • ALTERNATE 2 • RANDOM, U1-1 to U1-5, U2-1 to U2-5, U3-1 to U3-5 (15 User patterns) × 16 (240 User patterns when a 4 Mbyte memory cards is used).

□ MultiSet Play mode

This mode allows you to play MultiSets. A MultiSet has up to six timbres ("slots" for programs; refer to the diagram at right), and assigns a timbre program (program settings with the effect portion omitted) to each timbre, allowing you to play up to six different sound simultaneously. Each timbre program can be assigned to a different area of the keyboard, or to a different dynamic range.

The Z1 has 32 MultiSets in internal memory, grouped into two banks with 16 in each bank. When a memory

card (sold separately) is used, an additional 32 MultiSets can be added per bank.

Internal: A00 to A15, CARD B00 to CARD B15

When a card is inserted: CARD A00 to CARD A15, CARD B00 to CARD B15 (32 MultiSets) × 16 (512 MultiSets when a 4 Mbyte memory card is used).

In the same way as with Program Play mode, you can use the Z1's various controllers and editor to modify the sound of the MultiSet.

□ Program Edit mode

This mode allows you to edit a program. "Edit" refers to the process of modifying the values of various settings (parameters). In Program Edit mode, you can modify the values of the various parameters which make up a program, thus changing the sound.

□ MultiSet Edit mode

This mode allows you to edit a MultiSet. You can assign programs to each timbre, and make a variety of other settings.

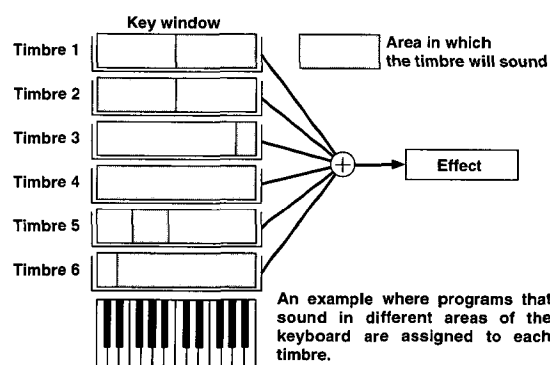

By setting parameters appropriately, you can use MultiSets in ways such as the following.

Layer

When the keyboard is played, two or more timbre programs will sound.

Split

Different timbre programs will sound, depending on the keyboard area that you play.

Velocity switch

Different timbre programs will sound, depending on the velocity (playing dynamics).

Multi-timbre

A different timbre program will sound on up to six channels. This allow the Z1 to function as up to six different MIDI tone generators.

□ Arpeggio mode

Here you can make various settings for the arpeggiator that you can use in Program Play mode or MultiSet Play mode. You can also create your own arpeggio patterns. User patterns allow you to create an arpeg-

gio pattern with up to 36 steps (see p.23). For preset patterns, you can modify parameters such as resolution, and the velocity and duration of the arpeggio notes to create a variety of arpeggio variations (see p.10).

□ MIDI mode

In this mode you can make settings that allow the Z1 to control external MIDI devices and to be controlled by external MIDI devices.

□ Global mode

In this mode you can make settings that affect the entire Z1, such as tuning. You can also use functions which restore the Programs or MultiSets to their factory settings.

..... Upgrading with optional boards

The Z1 comes standard with 12 voices of polyphony. By adding a <DSPB-Z1 option board (6 additional voices)>, polyphony can be expanded to a maximum of 18 voices. This will provide even better playability for electric piano or organ-type sounds, or for MultiSet Play mode.

Also, a <DI-TRI digital I/F board> can be added that incorporates ADAT compatible, optional outputs, so that the audio signal of the Z1 can be output digitally.

Front and rear panel

Front panel

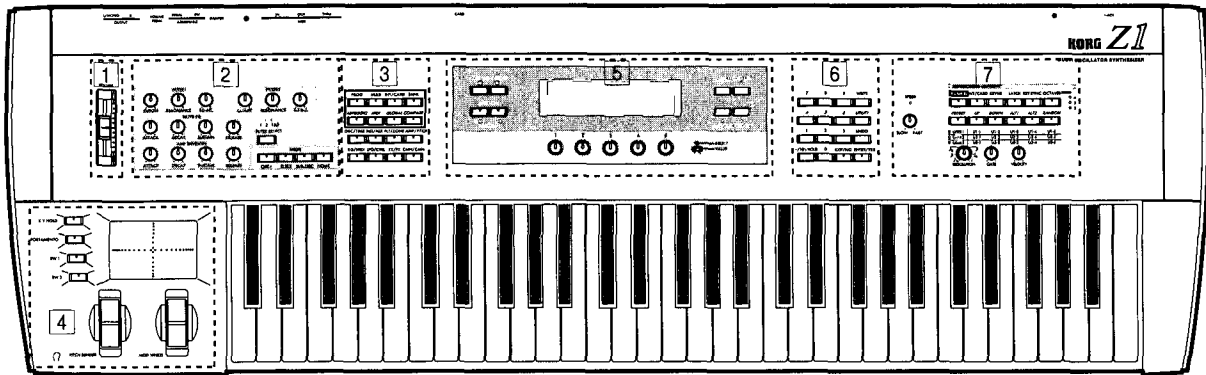

1 [VOLUME] slider

This slider adjusts the volume of the entire Z1. It adjusts the volume of the OUTPUT jacks (rear panel) and the volume of the PHONES jack.

2 FILTER1:

[CUTOFF] knob, [RESONANCE] knob, [EG INT] knob

FILTER2:

[CUTOFF] knob, [RESONANCE] knob, [EG INT] knob

FILTER EG:

[ATTACK] knob, [DECAY] knob, [SUSTAIN] knob, [RELEASE] knob, [FILTER SELECT] key

AMP ENVELOPE:

[ATTACK] knob, [DECAY] knob, [SUSTAIN] knob, [RELEASE] knob

MIXER:

[OSC1] key, [OSC2] key, [SUB OSC] key, [NOISE] key
These knobs and keys are collectively referred to as the "realtime editor." They allow you to modify the timbre and volum etc. in realtime.

3 [PROG] key, [MULTI] key, [ARPEGGIO] key, [MIDI] key, [GLOBAL] key

The many functions of the Z1 are organized into various groups, called "modes." Press one of these keys to enter the desired mode.

[INT/CARD] key, [BANK] key

These keys select the source and bank for the desired Program or MultiSet.

[COMPARE] key

This key allows you to return to the un-edited state after program parameters have been edited, or to return to the sound that you had been editing if you select another program without writing the edited data.

[OSC/TIMB] key, [MIX/MIX] key, [FLT/ZONE] key, [AMP/PITCH] key, [EG/MIDI] key, [LFO/CTRL] key, [FX/FX] key, [CMN/CMN] key

Editable parameters for Programs and MultiSets are grouped into "sections." Press the appropriate key to move to the desired section.

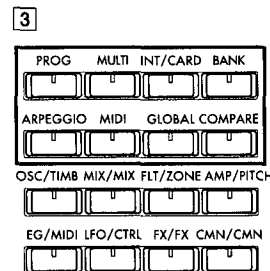
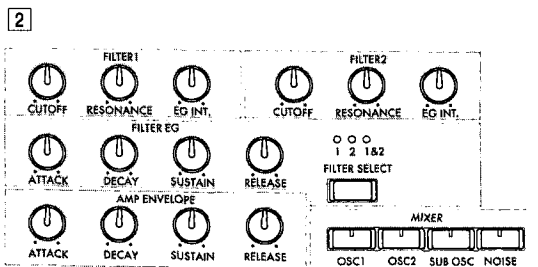
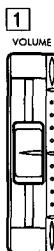

4 [X-Y HOLD] key

This selects whether or not the [X-Y PAD] effect will be maintained when you take your finger off the pad. When the function is being held, the switch LED will be lit.

[PORTAMENTO] key

This switches portamento on/off. When portamento is on, the switch LED will be lit.

[SW1] key, [SW2] key

These keys allow effects to be switched on/off, the keyboard to be shifted an octave up/down, or the polyphony to be switched between mono/poly. The function performed by these keys can be specified in the various Edit modes.

[X-Y PAD]

Assigned parameters such as pitch or modulation can be controlled by moving your finger in the X-Y directions on the controller.

[PITCH BENDER]

This is the pitch bend controller. Rotating the wheel will change the pitch.

[MOD WHEEL]

This is the modulation controller. Rotating the wheel will control modulation.

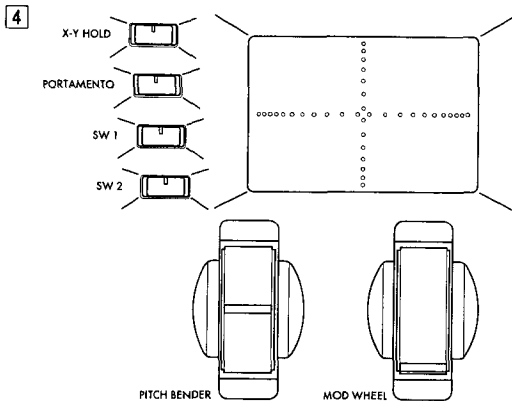

5 PAGE/USER GROUP: [◀] key, [▶] key

In Program Play mode, these keys select program numbers within the user group.

In the various editing modes, these keys move through the pages that appear in the display. Pressing the [◀] key will move to the page located to the left. Pressing the [▶] key will move to the page located to the right.

MENU (/DEMO): [JUMP] key, [TAB] key

When editing, these keys display a page menu and a tab menu. If both keys are pressed simultaneously, you will enter demonstration play mode.

VALUE/PROGRAM: [+] key, [-] key

In Program Play mode, these keys select program numbers. In MultiSet mode, they select MultiSet numbers. In the various editing modes, they modify the value of the parameter where the cursor is located.

CURSOR/CATEGORY; [▼] key, [▲] key

In Program Play mode, these keys select various categories of sounds. In the various editing modes, they move the cursor to a different line.

LCD

In each Play mode, this displays the name of the currently selected sound and the performance editor. In the various editing modes, this displays parameters.

[1] to [5] knobs

In each Play mode (Program or Multiset), you can rotate these knobs to modify the value of parameters assigned to them, causing the tone to change while you play. In the various editing modes, these knobs allow you to move between columns and lines, and to modify parameter values.

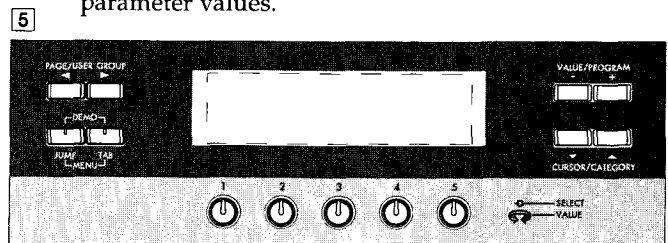

6 [0] to [9] numeric keys

In each Play mode, these keys select Program numbers or MultiSet numbers. In the various editing modes, they allow parameter values to be input numerically.

[-/10's HOLD] key

When selecting a Program number or MultiSet number in a Play mode, this key allows the 10's place to remain fixed, or the selection to be changed in steps of 10.

In the various editing modes, pressing this key will switch the sign of the parameter value between negative and positive.

[WRITE] key

This saves the currently selected Program, MultiSet, or arpeggio pattern settings.

[UTILITY] key

This key accesses various functions that assist your editing, such as Copy and Initialize.

[UNDO] key

This key restores the original value of an individual parameter after it has been modified.

[ENTER/YES] key

This key is used to finalize a value or execute an operation. When finalization or execution is required, a message will be displayed.

[EXIT/NO] key

Use this key if you decide not to finalize or execute, or to exit from an edit mode.

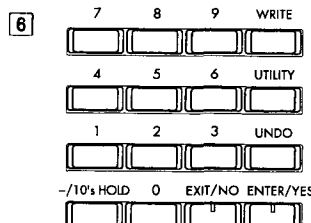

ARPEGGIATOR

7 [ON/OFF] key

This switches the arpeggio function on/off. When it is on, the LED will be lit.

[INT/CARD] key

This key selects whether the arpeggio pattern will be selected from internal memory or from a memory card. The selection will alternate each time the key is pressed. When the LED is lit, card patterns are selected.

[KEYBD] key, [LATCH] key, [KEY SYNC] key, [OCTAVES] key

These keys specify the operation of the arpeggiator.

[KEYBD]: When the LED is dark, only the arpeggio will be heard. When the LED is lit, the keyboard will sound simultaneously with the arpeggio.

[LATCH]: When the LED is lit, the arpeggio will continue repeating even after key-off.

[KEY SYNC]: When the LED is lit, the arpeggio pattern will playback from the beginning when you release all notes and play again.

[OCTAVES]: This key selects the range (in octave units) in which the arpeggio will play.

[PRESET/USER] key

This key selects the bank of the preset pattern or user pattern. The bank will change each time the key is pressed.

PATTERN SELECT: [UP] key, [DOWN] key, [ALT1] key, [ALT2] key, [RANDOM] key

These keys select preset arpeggio patterns (UP to RANDOM) or user patterns (U1-1 to U3-5).

[RESOLUTION] knob, [GATE] knob, [VELOCITY] knob

These knobs regulate how the notes of the arpeggio are sounded.

[RESOLUTION]: This modifies the base timing of the arpeggio. [GATE] modifies the length that each note will sound of the arpeggio. [VELOCITY] modifies the playing strength of the notes in the arpeggio.

[SPEED] knob

This adjusts the tempo of the arpeggiator. The LED above the knob will blink at quarter-note intervals.

If the arpeggiator is being controlled by MIDI clock messages from an external device, the setting of this knob will be ignored.

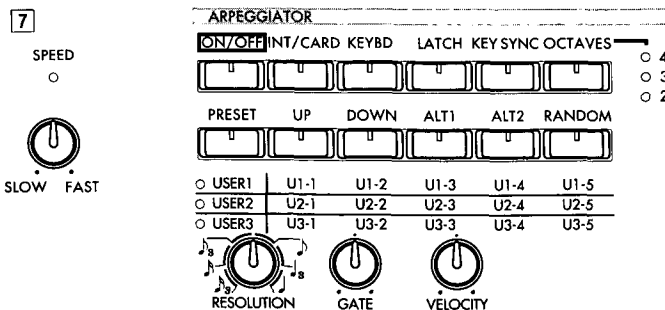

Rear panel

1 AC power supply inlet

Connect the included power cable to this inlet.

POWER (power switch)

This turns the power on/off ①.

2 OUTPUT jacks (L/MONO, R)

These are the output jacks. They can be connected to powered monitor speakers, a stereo amp, a mixer, or a multi-track recorder, etc. If you are listening in monaural, use the L/MONO jack.

3 DAMPER jack

A switch pedal can be connected to this jack. Pressing the pedal will apply the damper effect.

ASSIGNABLE SW jack

A switch pedal can be connected to this jack. Pressing the pedal will turn the specified function on/off, etc.

ASSIGNABLE PEDAL jack

A volume pedal can be connected to this jack. Operating the pedal will control the assigned function.

VOLUME PEDAL jack

A volume pedal can be connected to this jack. Operating the pedal will control the volume.

4 MIDI THRU connector

MIDI messages received at the MIDI IN connector are retransmitted without change from this connector.

MIDI OUT connector

MIDI messages are transmitted from this connector. Use this connector when you wish to control an external MIDI device.

MIDI IN connector

MIDI messages are received at this connector. Use this connector when you wish to play the sounds of the Z1 from another instrument, etc.

5 WORD CLOCK IN connector

This is the system clock input connector. In order to use this functionality, you must install an optional DI-TRI digital I/F board (sold separately) (refer to p.109).

DIGITAL OUT connector (Digital I/F format)

In order to use this functionality, you must install an optional DI-TRI digital I/F board (sold separately) (refer to p.109).

6 MEMORY CARD

An optional card can be inserted here can provide (or be used to store) additional programs, MultiSets, and arpeggiator patterns (refer to p.110).

7 Contrast

This adjusts the LCD contrast. The readability of the screen display may vary depending on your viewing height or angle, so you can change this adjustment as necessary.

Connections

⚠ Be sure to turn the power off before making connections. Careless operation while making connections can damage your speaker system, and may cause malfunctions.

1. Connecting the power cable

- ❖ Connect the included power cable. First connect the power cable to the Z1, and then connect the other end to an AC outlet.

2. Connecting audio equipment

- ❖ Use audio cables to connect the Z1's OUTPUT jacks (L/MONO, R) to your mixer or powered monitor system (amplified speaker).
In order to take full advantage of the Z1's sound, we recommend that you listen in stereo. If you are making monaural connections, connect the L/MONO jack, and set the GLB Ctrl SetUp page "Output Mode" setting to MONO.
- ❖ If you wish to use headphones, connect them to the PHONES jack located on the left front of the Z1.

3. Connecting pedals, etc.

By connecting volume pedals and switch pedals, you can enjoy a wider range of performance control. Pedals can be connected as desired. The Global mode page GLB Basic "Polarity" setting allows you to specify the pedal polarity (Max/Min state) (see p.91).

DAMPER jack

If you wish to control the damper effect from a pedal, connect a switch-type pedal such as the DS-1H (sold separately) damper pedal or PS-1/2 (sold separately) pedal to the DAMPER jack.

ASSIGNABLE SW jack

- ① If you wish to use a pedal to control the sustain effect, octave up/down, the portamento effect, or arpeggiator on/off etc., connect a PS-1/2 switch pedal (sold separately) or DS-1H damper pedal (sold separately) to the ASSIGNABLE SW jack.
- ② The function of this pedal can be specified independently for each program or MultiSet. This is done using the "Assignable SW Function" setting (refer to p.62, 82) of Program Edit mode or MultiSet Edit mode.

ASSIGNABLE PEDAL jack

- ① If you wish to use a pedal to control breath controller, volume, pan, or expression etc., connect an EXP-2 or XVP-10 foot controller (sold separately) to the ASSIGNABLE PEDAL jack.
- ② The function of this pedal can be specified independently for each program or MultiSet. This is done using the "Assignable SW Function" setting (refer to p.62, 82) of Program Edit mode or MultiSet Edit mode.

VOLUME PEDAL jack

- ① If you wish to control volume (either volume or expression) using a pedal, connect an EXP-2 or XVP-10 foot controller (sold separately) to the VOLUME PEDAL jack.
- ② Set the function to either Volume or Expression. This setting is made by the GLB Ctrl SetUp page "Volume Pedal Function" parameter (p.93).

4. Connections with MIDI equipment

If you wish to connect external MIDI equipment, use MIDI cables to make connections to the MIDI connectors of the other devices. For details refer to p.97.

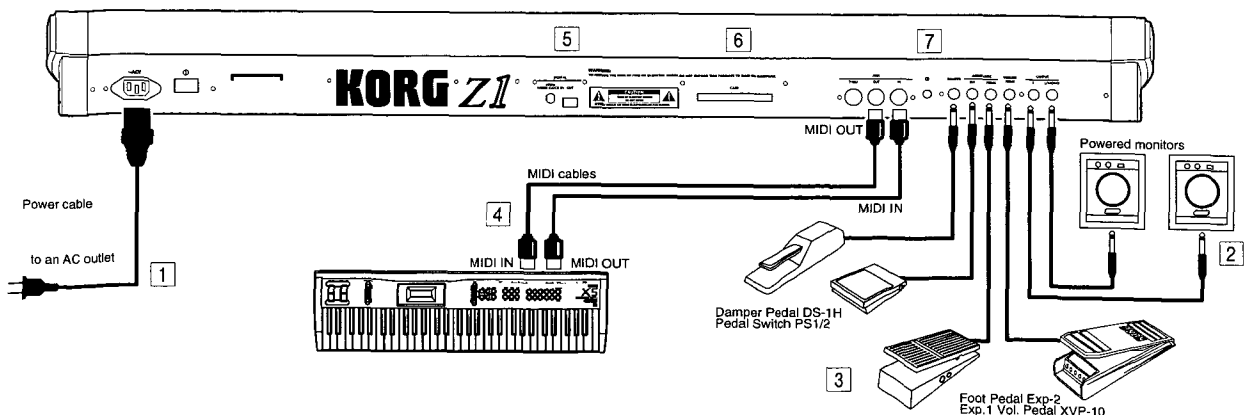

Quick-start Guide

Basic Operation and
Performance Editing,
Editing

Basic Operation and Performance Editing

1. Check the connections

Refer to "Connections" (p.xiii) and make the appropriate connections.

2. Turning the power on/off

Turning the power on

- Press the [POWER] switch of the Z1 to turn the power on.

The Program Play mode or MultiSet Play mode display will appear. With the factory settings, you will be in Program Play mode with program A000 selected.

If the Global mode page GLB Basic "Page Memory" setting is turned ON, the program or MultiSet that was last selected when the power was turned off will be selected. Refer to "Using the Page Memory function" (p.91).

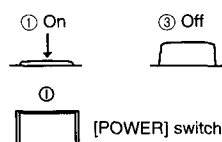

- Turn on the power of your powered monitor system or stereo amp.

Turning the power off

- Press the [POWER] switch once again, and the power of the Z1 will be turned off. Turn off your powered monitor speaker system or stereo amp before turning the Z1 off.

3. Adjusting the volume

- Raise the [VOLUME] slider to adjust the volume to an appropriate level. The volume of the headphones is also controlled by the [VOLUME] slider.

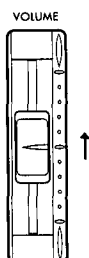

4. Listen to the demo songs

The Z1 contains several built-in demo songs. Listen to the demo songs to experience the Z1's rich sounds and expressive possibilities.

- Hold down the [JUMP] key and press the [TAB] key, and you will enter the demonstration mode.

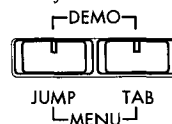

The LCD will indicate the demo songs.

- Press the knob [3] and then, the songs will begin playback successively, starting with song 01.
- To stop playback or select another song, press the appropriate knob [1] to [5] or key.

Knob [1]: Select the previous song. During playback, return to the beginning of the current song.

Knob [2]: Stop playback.

Knob [3]: Playback.

Knob [4]: Select the next song.

Knob [5]: Exit demonstration mode.

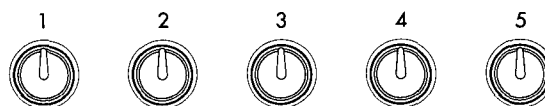
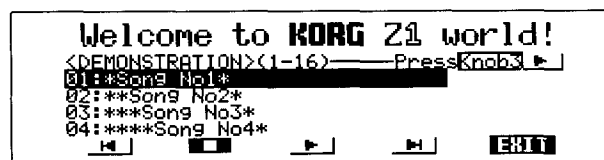

[▼] key: Same function as knob [4].

[▲] key: Same function as knob [1]



CURSOR/CATEGORY

[EXIT] key: Same function as knob [5].



5. Playing a program

Now let's select and play a program. At this time you can also try out the Z1's various controllers and knobs, to hear the results for yourself. For details on the controllers and knobs, refer to the following sections "7. Using various controllers to modify the sound," "8. Using the realtime editor to modify the sound," and "9. Using the performance editor to modify the sound."

With the factory settings, some programs will automatically turn the arpeggiator on when they are selected (the ARPEGGIATOR [ON/OFF] key LED will light). For details on the arpeggiator, refer to "10. Using the arpeggiator."

Select Program Play mode

- Press the [PROG] key (the LED will light) to enter Program Play mode.

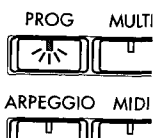

The following display will appear.

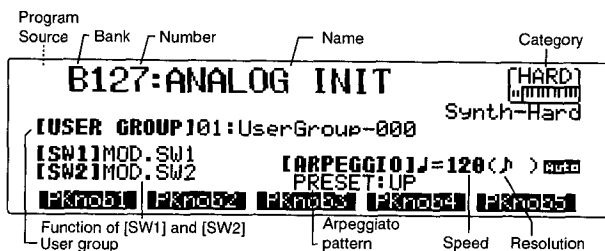

Select a program bank

- Press the [BANK] key to select the bank (A/B). The bank will change each time the key is pressed.

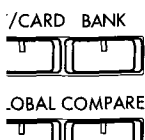

When bank A is selected, the LCD program bank field will indicate "A," and the [BANK] key LED will be dark. When bank B is selected, the LCD program bank field will indicate "B," and the [BANK] key LED will be lit.

If you operate the realtime editor or performance editor, or modify the sound in Program Edit mode and then return to Program Play mode, the LCD program bank indication will change to lowercase characters (a/b), indicating that the program has been edited. If you select a different program or save the program, your edits will be canceled or saved, and this display will return to uppercase.

Select a program number

Each bank contains 128 programs (000-127). Use one of the following methods to select a program.

Using the [+] and [-] keys

- Press the [+] key to increase the program number by 1, or press the [-] key to decrease it by one.



Using the numeric keys [0] to [9]

- Use the numeric keys to enter the desired program number, starting with the upper digit. The LCD will show a list of the programs which can be finalized by the next numeric key input.

7	8	9	WRITE
[]	[]	[]	[]
4	5	6	UTILITY
[]	[]	[]	[]
1	2	3	UNDO
[]	[]	[]	[]
-/10's HOLD	0	EXIT/NO	ENTER/YES
[]	[]	[]	[]
- If the program list is still displayed even though you have finished inputting the number, press the [ENTER] key to finalize the input.

Using the [10's HOLD] key

- If you press the [10's HOLD] key to turn the function on (the LCD will indicate "HOLD"), you can select programs as follows. Pressing numeric keys [0] to [9] will change only the one's place, and the 10's and 100's place will remain fixed. Pressing the [+] or [-] keys will change the program number in steps of 10.

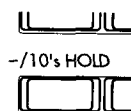

To turn off the 10's HOLD function, press the [10's HOLD] key once again, or press the [EXIT] key.

Selecting programs of the same category

You can search for and select other programs that are in the same category as the currently selected program. There are 18 different categories. Normally, categories are used to distinguish types of sound; like organs, synth pads, etc.

- Press the CATEGORY [▼] key, and the next program (closest-numbered) in the same category will be selected. Press the [▲] key, and the previous program (closest-numbered) in the same category will be selected.

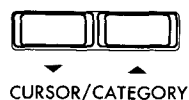

❑ Selecting programs of the same user group

You can search for and select other programs that are in the same user group as the currently selected program. There are 16 different user groups. User groups provide a convenient way to classify sounds by performer or song.

- ✦ Press the USER GROUP [▶] key, and the next program (closest-numbered) in the same user group will be selected. Press the [◀] key, and the previous program (closest-numbered) in the same user group will be selected.



You can freely assign your own user group names (see p.92).

❑ Selecting programs by category or user group

You can search for programs by category or user group and select them.

- ① Press the [UTILITY] key.

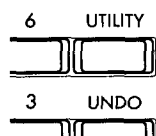

The bottom line of the LCD will show the UTILITY menu.

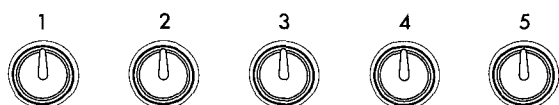

- ② To select from a user group, press knob [2] (UsrGrp). To select from a category, press knob [3] (Categr). The corresponding UTILITY window will appear.
- ③ Rotate knob to select the desired user group or category, and press the [ENTER] key to execute your selection.

Programs in the specified user group or category will be located, and the program will change.

If the specified user group or category is not found, the display will indicate "NotFound," and will wait for your response. To cancel the operation, press the [EXIT] key.

❑ Other ways to select programs

- ✦ Programs can be selected by incoming MIDI program change messages (see p.98).

❑ Selecting programs from a card

- ✦ Memory cards (sold separately; see p.110) must be formatted before they can be used. When a memory card containing Z1 programs is inserted, card programs can be selected.

- ✦ Press the [INT/CARD] key to select either internal programs or memory card programs. The source will alternate each time the key is pressed.

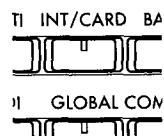

When the card is selected, the LCD program source area will indicate "CARD" and the [INT/CARD] key LED will light.

6. Playing a MultiSet

Now let's select and play a MultiSet. At this time you can use the Z1's various controllers and knobs, and the arpeggiator in the same way as when playing a program.

Select MultiSet Play mode

- Press the [MULTI] key (the LED will light) to select MultiSet Play mode.

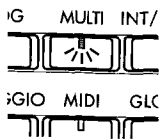

The following display will appear.

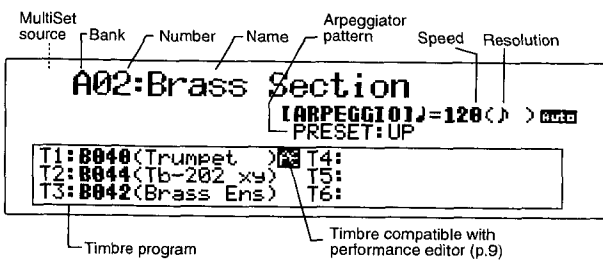

Select the MultiSet bank

- Press the [BANK] key to select the bank (A/B). The bank will change each time the key is pressed.

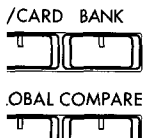

When bank A is selected, the MultiSet bank field in the LCD will indicate "A," and the [BANK] key LED will be dark. When bank B is selected, the MultiSet bank field will indicate "B," and the [BANK] key LED will be lit.

If you operate the realtime editor or performance editor, or modify the sound in MultiSet Edit mode and then return to MultiSet Play mode, the MultiSet bank indication in the LCD will change to lowercase characters (a/b), indicating that the MultiSet has been edited. If you select a different MultiSet or save the MultiSet, your edits will be canceled or saved, and this display will return to uppercase.

Select the MultiSet number

Each bank contains 16 MultiSets (00 to 15). As when selecting programs, you can use the [+]/[-] keys, the numeric keys [0] to [9], and the [10's HOLD] key to select the MultiSet number.

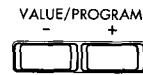
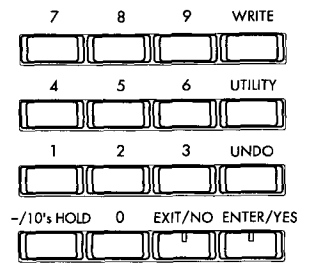

Other ways to select a MultiSet

- MultiSets can be selected by incoming MIDI program change messages (see p.98).

Selecting MultiSets from a card

- Memory cards (sold separately; see p.110) must be formatted before they can be used. When a memory card containing Z1 MultiSets is inserted, card MultiSets can be selected.

- Press the [INT/CARD] key to select either internal MultiSets or memory card MultiSets. The source will alternate each time the key is pressed.

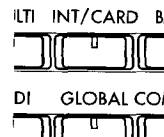

When the card is selected, the LCD program source area will indicate "CARD" and the [INT/CARD] key LED will light.

7. Using various controllers to modify the sound

The Z1 provides a variety of controllers that allow you to control the sound. By operating these controllers, you can modify the pitch, volume, and brightness etc. of the sound while you play. Since settings for these controllers can be made independently for each program (or MultiSet), you can use them to achieve a wide variety of control.

Using the [X-Y PAD]

The sound can be modified by moving your finger left/right and up/down (X-Y axes) on the [X-Y PAD] in various directions.

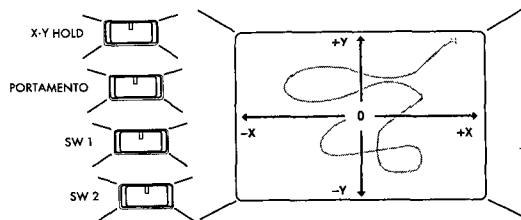

Using the [X-Y HOLD] function

- ◆ If you press the [X-Y HOLD] key to turn this function on (LED lit), the changes in sound being controlled by the [X-Y PAD] will continue to apply even after you take your finger off the [X-Y PAD]. If this function is off (LED dark), the effect of the [X-Y PAD] will stop at the moment that you release your finger from the pad. The function will alternate on/off each time this key is pressed.

The [X-Y HOLD] on/off setting can be stored for each program and multiset using the Write operation (see p.26). However, the [X-Y PAD] location that was being held will not be stored.

Using the [PORTAMENTO] control

Portamento is an effect which creates a smooth pitch change between one note and the next-pressed note (see p.30).

- ◆ To apply this effect, press the [PORTAMENTO] key to turn the function on (LED lit). This setting will alternate on/off each time the key is pressed.

 If the Program Edit mode OSC section page OSC Set Up "Portamento Time" setting is 0, there will be no portamento even if the [PORTAMENTO] key is turned on.

The [PORTAMENTO] on/off setting can be stored for each program and multiset using the Write operation (see p.26).

Using the [SW1] and [SW2] keys

By pressing these keys to turn them on (LED lit), you can switch settings such as moving the keyboard octave up/down, turning effects on/off, or switching between monophonic/polyphonic (see p.62 and p.82).

Using the [PITCH BENDER]

You can move the [PITCH BENDER] toward yourself or away from yourself to modify the sound. Normally this is used to control pitch. On some programs which use a **BRASS** or **REED** oscillator type, the pitch bender produces the "mode jump" effect that is characteristic of wind instruments.

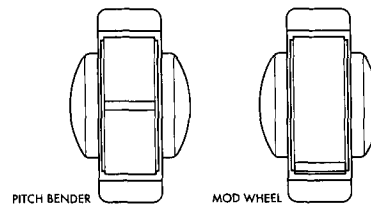

Using the [MOD WHEEL]

You can move the [MOD WHEEL] away from yourself to modify the sound. Normally this is used to control the depth of vibrato or wah.

Using the keyboard

Note Number

The note number (keyboard position) can be used to modify the sound. Normally the note number is used to control aspects of the sound such as volume, brightness, and attack.

Velocity

The force with which you play the keyboard can be used to modify the sound. Normally this is used to control aspects of the sound such as volume and attack.

After Touch

Pressure applied to the keyboard after striking a note can be used to modify the sound. Normally this is used to control aspects of the sound such as vibrato depth or brightness.

Using controllers connected to the rear panel <Optional>

DAMPER (Damper pedal)

Sounds can be modified by pressing or releasing a pedal.

Normally this is used to control the damper pedal effect of an acoustic piano. (See p.xiii)

ASSIGNABLE SW (Assignable switch)

Sounds can be modified by pressing or releasing a pedal.

A function such as sustain pedal, octave up/down, portamento, or on/off switching for effects or the arpeggiator can be assigned to this switch. (See p.xiii, p.62 and p.82)

ASSIGNABLE PEDAL (Assignable pedal)

The sound can be controlled by the depth to which a pedal is pressed or returned.

A function such as breath controller, volume, pan or expression can be assigned to this pedal for control. (See p.xiii, p.62 and p.82)

VOLUME PEDAL (Volume pedal)

The volume can be controlled by pressing or releasing a pedal. This pedal can control either volume or expression. (See p.xiii and p.93)

❑ How to assign sound-modifying functions to a controller

A wide variety of functions can be assigned to these controllers to control pitch, tone and volume. The following lists give only the categories.

Controllers which can be used as modulation sources

[X-Y PAD], [PORTAMENTO], [SW1] key, [SW2] key, [PITCH BENDER], [MOD WHEEL], Velocity, After Touch, Note Number, DAMPER, ASSIGNABLE SW, ASSIGNABLE PEDAL. (Knobs [1] to [5] can be used as modulation source. For details refer to p.19.)

Controllers to which individual functions can be assigned

In addition to being used as modulation sources, [SW1] key, [SW2] key, [PITCH BENDER], DAMPER, ASSIGNABLE SW, and ASSIGNABLE PEDAL can also be assigned the various functions explained above.

🔊 In MultiSet Play mode, you can use the MultiSet Edit mode MLT Ctrl Fltr page settings to restrict the operation of these controllers for each timbre (refer to p.80).

8. Using the realtime editor to modify the sound

While playing in Program Play mode or MultiSet Play mode, you can operate the 14 knobs and five keys located at the left side of the Z1 to modify the tone and volume etc. On the Z1, these 14 knobs and keys are collectively referred to as the "realtime editor." By operating these controls you can give a wide variety of variation to the sound without entering an Edit mode.

❑ Modifying the cutoff frequency to vary the brightness of the sound

If you rotate the [CUTOFF] knob of FILTER1 or FILTER 2, the "Cutoff Frequency" setting (see p.16 and p.53) of the respective filter will increase or decrease, affecting the brightness of the sound.

The result will depend on the filter type that is specified for each program (MultiSet). However for the low pass filter (LPF) that is widely used on synthesizers, rotating the knob toward the right will normally brighten the tone, and rotating it toward the left will darken the tone.

❑ Modifying the resonance to give character to the sound

If you rotate the [RESONANCE] knob of FILTER1 or FILTER 2, the "Resonance" setting (see p.16 and p.53) of the respective filter will increase or decrease, giving a unique character to the sound.



❑ Causing the brightness to vary over time

The various knobs and keys of the FILTER EG can be used to change the way in which the brightness of the sound varies over time.

Adjusting the depth of the FILTER EG

Rotate the [EG INT.] knob of FILTER1 or FILTER2, and the depth of the FILTER EG effect will change (refer to "Cutoff Frequency Mod. EG Intensity" p.16 and p.53).

Selecting the FILTER whose EG you wish to modify

You can select the filter whose FILTER EG will be affected by your adjustments. Each time you press the [FILTER SELECT] key, the LEDs will light consecutively: when "1" is selected only the FILTER EG of filter 1 will be affected, when "2" is selected only filter 2, and when "1&2" is selected both filters 1 and 2 will be affected.

🔊 In Program Play mode, the function of this key may be fixed by the filter settings of the currently selected program. If the same EG is being used by "Cutoff Frequency Mod. EG" (see p.53) of both filter 1 and filter 2, this setting will automatically be fixed at "1&2." Also, if "Filter Link SW" (see p.52) is on, "1" will be selected. In MultiSet Play mode the functioning will be similar.

Modifying the brightness of the attack

By rotating the [ATTACK] knob you can adjust the time over which the brightness changes from key-on until the attack level is reached.

Normally, rotating the knob toward the right will cause the tone to brighten gradually, and rotating the knob toward the left will cause the tone to brighten quickly.

Modifying the brightness of the decay

By rotating the [DECAY] knob you can adjust the time over which the brightness changes from the attack level until the sustain level is reached.

Normally, rotating the knob toward the right will cause the tone to darken gradually, and rotating the knob toward the left will cause the tone to darken quickly.

Modifying the brightness of the sustained sound

By rotating the [SUSTAIN] knob you can adjust the brightness of the sustained sound.

Modifying the brightness of the decaying sound after the key is released

By rotating the [RELEASE] knob you can adjust the time over which the brightness changes after key-off until it decays to silence.

Normally, rotating the knob toward the right will cause the tone to darken gradually, and rotating the knob toward the left will cause the tone to darken quickly.

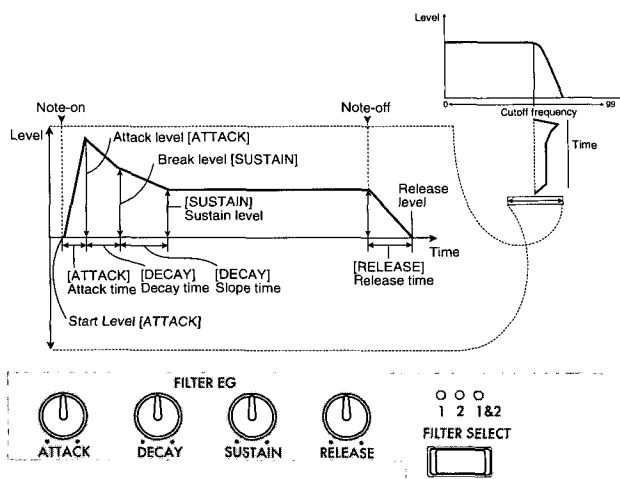

Causing the volume to vary over time

The various knobs of the AMP ENVELOPE can be used to change the way in which the volume varies over time. (Refer to p.17 and "Amplitude Mod. EG" p.55)

Modifying the speed of the attack

By rotating the [ATTACK] knob you can adjust the time from key-on until the sound reaches the attack level.

Normally, rotating the knob toward the right will cause the sound to attack gradually, and rotating the knob toward the left will cause the sound to attack quickly.

Modifying the speed of the decay

By rotating the [DECAY] knob you can adjust the time from when the attack level is reached until the sound

falls to the sustain level.

Normally, rotating the knob toward the right will cause the sound to decay gradually, and rotating the knob toward the left will cause the sound to decay quickly.

Modifying the sustain volume

By rotating the [SUSTAIN] knob, you can adjust the volume at which the sound will be sustained.

Modifying the speed at which the sound decays after the key is released

By rotating the [RELEASE] knob, you can adjust the time over which the sound decays after key-off until it decays to silence.

Normally, rotating the knob toward the left will cause the sound to decay more gradually, and rotating the knob toward the right will cause the sound to decay more quickly.

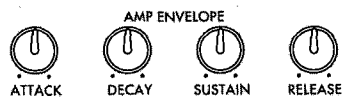
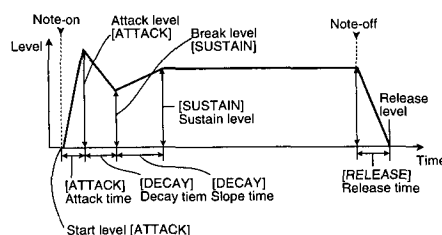

Mute an oscillator to modify the sound

The tone generator portion of a Z1 program contains two oscillators, a sub oscillator, and a noise generator (see p.15). You can modify the sound by changing the combination of these elements.

- Pressing the [OSC1] key, [OSC2] key, [SUB OSC] key or [NOISE] key to turn off the LED will mute the corresponding oscillator so that it will not sound.

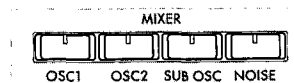

- In MultiSet Play mode, the performance editor will be enabled only for the timbre whose MultiSet Edit mode MLT Controller Fltr page "P_Edit" setting is set to ENA. Only one of the six timbres can be set to ENA (refer to p.80).

Saving a sound that you modified using the realtime editor

Sound program that you modified using the realtime editor in Program Play mode can be saved (see p.26). In MultiSet Play mode it is not possible to save a modified sound program. "Saving a sound that you modified using the Performance Editor" (refer to p.9).

9. Using the performance editor to modify the sound

While playing in Program Play mode or MultiSet Play mode, you can operate the five knobs located below the LCD to modify various parameters that change the pitch, tone and volume. On the Z1, these knobs are collectively referred to as the "performance editor." By operating these knobs, you can modify the sound in various ways without entering an Edit mode. While each knob or key of the realtime editor has a fixed function, each knob of the performance editor can have up to four desired parameters assigned to it. (You can select from 439 different parameters. Refer to p.107) This makes it possible for you to modify the sound in complex ways.

Furthermore, each knob of the performance editor can function as a modulation source just like the controllers ([X-Y PAD], [MOD WHEEL] etc.) that were discussed in "7. Using various controllers to modify the sound." (see to p.6)

 The performance editor cannot be used while a Program or MultiSet is being selected (i.e., while a list is displayed).

Using the performance editor to control the sound

In Program Play mode

◇ When you rotate a knob [1] to [5], sliders which represent the values of the parameters assigned to each knob will move, and the sound will change.

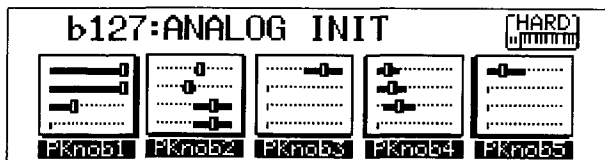

◇ When you press a knob [1] to [5], the LCD will show the sliders which represent the values of the assigned parameters, and will also display the parameter names.

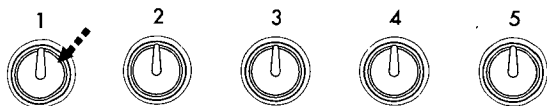
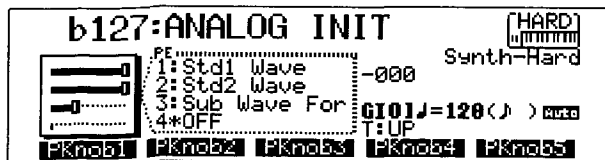



A wide variety of parameters which control the sound can be assigned to performance editor knobs [1] to [5] (see p.20 and p.63).

In MultiSet Play mode

In the case of MultiSets that can be controlled by the Performance Editor, an indication of "PE" will be shown beside one of the timbre programs. The performance editor will be active for this timbre program. The performance editor settings of the program itself will be used.

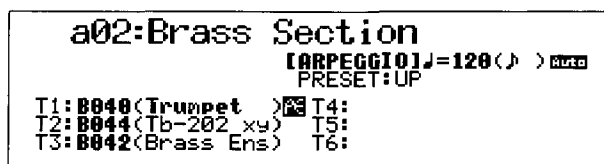
◇ When you rotate knobs [1] to [5], the sound will be modified according to the parameters that were specified for the "PE" timbre program.



 In MultiSet Play mode, the performance editor will be enabled only for the timbre whose MultiSet Edit mode MLT Controller Fltr page "P_Edit" setting is set to ENA. Only one of the six timbres can be set to ENA (refer to p.80).

Saving a sound that was modified using the Performance Editor

In Program Play mode, you can save a sound that you modified using the performance editor (refer to p.26). In MultiSet Play mode, a modified sound cannot be saved.

However when a timbre program used in a MultiSet is the same as the program selected in Program Play mode, the timbre program in MultiSet Play mode will be displayed in bold characters. In this case, modifications made to the sound using the realtime editor or performance editor will be determined to be program editing. (The bank display of the timbre program will change from uppercase characters to lowercase characters.) You can move to Program Play mode or to Program Edit mode, and then save the modified sound.

10. Using the arpeggiator

The Z1's arpeggiator contains five preset patterns (UP, DOWN, ALTERNATE1, ALTERNATE2, RANDOM) and 15 user patterns (U1-1 to U3-5). Select an arpeggio pattern, and play a Program or MultiSet.

Turning on the arpeggiator

Press the ARPEGGIATOR [ON/OFF] key to turn it on (LED lit). Arpeggiation will begin when you play the keyboard. Arpeggio patterns can be polyphonic by specifying two or more tones for steps within the pattern. Press the key once again to turn off the arpeggiator.

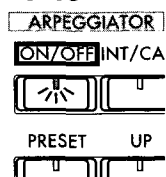

Adjusting the arpeggiator tempo

Rotate the [SPEED] knob to set the desired tempo.

You can also synchronize the tempo with an external MIDI device (see p.86). In this case, the knob setting will be ignored.

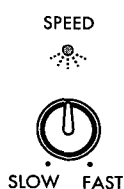

Changing the base timing of the arpeggiated notes

Rotate the [RESOLUTION] knob to set the base timing of the arpeggiated notes. You can select a setting from sixteenth note triplets to quarter notes.



Selecting the arpeggio bank

Press the [PRESET/USER] key to select the bank (PRESET to USER3). Each press of the key will cycle consecutively through the banks.

Selecting the arpeggio pattern

Use PATTERN SELECT ([UP] to [U3-5] keys) to select the arpeggio pattern. The display will indicate the pattern name.

	PRESET	UP	DOWN	ALT1	ALT2	RANDOM
☀ USER1		☀				
○ USER2						
○ USER3						

Selecting arpeggio patterns from a card

If a memory card (sold separately; refer to p.110) in which Z1 arpeggio patterns have been saved is inserted, you can select arpeggio patterns from the card.

Press ARPEGGIATOR [INT/CARD] to specify whether you wish to use internal arpeggio patterns or memory card arpeggio patterns. The selection will alternate each time you press the key.

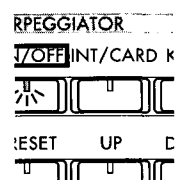

Playing keyboard notes together with arpeggio notes

If you press the [KEYBD] key to turn this function on (LED lit), notes played on the keyboard will be sounded as well, so that the chord you play on the keyboard will sound simultaneously with the arpeggio. The setting will alternate on/off each time you press the key.

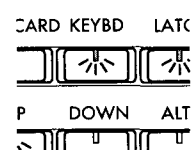

Causing the arpeggio to continue playing after you release the notes

If you press the [LATCH] key to turn this function on (LED lit), the arpeggio will continue playing even after you take your hand off the keyboard. The setting will alternate on/off each time you press the key.

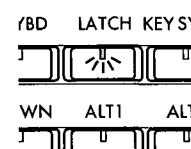

❑ Causing the arpeggio to play through multiple octaves

By pressing the [OCTAVE] key you can cause the arpeggio to extend through multiple octaves. As the LED is switched through settings of 2 → 3 → 4, the arpeggio will change to cover the corresponding number of octaves.

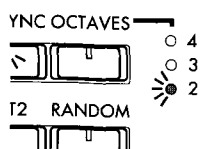

⚠ If a user pattern is selected, the operation of this function will depend on the "Octave Motion" setting.

❑ Applying key-sync to the arpeggiator

If you press the [KEY SYNC] key to turn this function on (LED lit), the arpeggio pattern will start over from the beginning at the first key-on that follows the releasing of all notes. When you are playing together with other instruments, you can use this function to make sure that the beginning of each measure is aligned correctly.

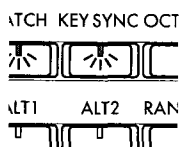

❑ Changing the length of the arpeggiated notes

You can use the [GATE] knob to adjust the length of the arpeggiated notes. Rotating the knob toward the left will make the notes shorter, and rotating it toward the right will make them longer.



❑ Changing the loudness of the arpeggiated notes

You can use the [VELOCITY] knob to adjust the loudness of the arpeggiated notes. Rotating the knob toward the left will make the notes softer, and rotating it toward the right will make them stronger.



❑ Saving the arpeggiator on/off setting etc.

When writing a program or MultiSet (refer to p.26), the status of the arpeggiator can be saved together with the program or MultiSet settings.

The following settings will be saved: arpeggio [ON/OFF] key, pattern, [SPEED] key, [KEYBD] key, [LATCH] key, [KEY SYNC] key, [OCTAVES] key, [RESOLUTION] knob, [GATE] knob, and [VELOCITY] knob.

⚠ These settings will be valid when the Global mode "Auto-Arpeggio SetUp Program" or "Auto Arpeggio SetUp MultiSet" settings are ON.

❑ Linking the arpeggiator to a program or MultiSet

When you select a program or MultiSet, the status of the arpeggiator will be switched together with the program or MultiSet. Refer to "Saving the arpeggiator on/off setting etc."

⚠ These settings will be valid when the Global mode "Auto-ArpeggioSetUp Program" or "Auto Arpeggio SetUp MultiSet" settings are ON. In each Play mode, the display will indicate "AUTO."

⚠ In MultiSet Play mode, arpeggio playing will be enabled only if the MultiSet Edit mode MLT MIDI&Arp page setting "Arpeggio" is set to ENA, and only for timbres whose transmit/receive channel matches the Global MIDI channel (refer to p.79)

Editing

1. Restoring the factory settings

The factory settings are referred to as the "factory preset data," and this data can be recalled to restore the Z1's Programs, MultiSets, arpeggio patterns, and other mode settings to their factory condition.

If you are using the editing operations described in this section and get into a situation where there is no sound or you are unsure of how to proceed, you can use the following procedure to bring back the factory preset data.

There are two ways in which the factory preset data can be brought back: it can be written into internal memory, or it can be called into the edit buffer. With the first method, the data will be written into internal memory without your having to perform the Write operation. The second method would normally be used when you wish to use the factory preset data as the basis for editing, and the data would not be saved in internal memory unless you perform the Write operation. Here we will explain the procedure by which the factory preset data is written directly into internal memory. For the procedure of recalling factory preset data into the edit buffer, refer to p.28.

⚠ Be aware that when you perform the following procedure, the contents of internal memory (all of your own original data that you created and stored) will be lost. If you wish to keep this data, be sure to save it to a memory card or data filer before executing the following procedure (see p.88 and p.95).

- 1 Press the [GLOBAL] key to enter Global mode.



- 2 Press the [JUMP] key, and then press knob [5] (UTY's) to access the GLB Data Utility page.

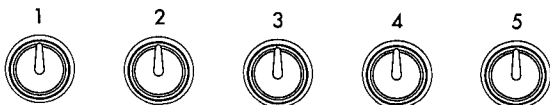
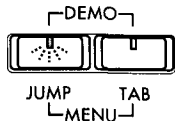

- 3 Press knob [2] several times to move the cursor to the "Factory (Load Source)" line.
- 4 You can choose whether to restore the factory preset data for an individual Program or MultiSet, or for a specific mode. However in this example we will show how to restore the factory preset data for all settings. Rotate knob [2] to select All_Data.
- 5 Press the [ENTER] key and a message will ask for confirmation. If you wish to recall the factory preset data, press the [ENTER] key once again. If you decide to cancel the operation, press the [EXIT] key. Pressing it once will cancel the operation, and pressing it again will return you to the previous Play mode.

2. About the edit mode display

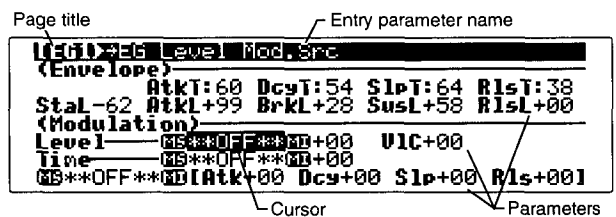

Page title

This indicates the name of the currently selected page. Each of the edit modes consists of multiple pages.

Parameters

Each page contains several related parameters. By modifying the values of these parameters you can modify the sound or change the system settings.

Cursor

The highlighted area indicates the parameter that is being edited. You can use knobs [1] to [5], the [+] key and the [-] key to modify the value.

Entry parameter name

This indicates the name of the parameter which is selected for editing (i.e., the parameter where the cursor is located).

3. Basic editing procedure

Here we will explain the basic procedure for editing.

□ Select a mode (and section)

First, select the mode in which you wish to edit.

Program Edit mode

- ① In Program Play mode, select the program that you wish to edit. (Refer to "Playing a program.") If you wish to start editing from an initialized state, refer to "Initializing settings (Init)" (p.28).
- ② To select the desired section of Program Edit mode, press the appropriate section key to make the LED light. (The [PROG] key LED will blink.)

[OSC/TIMB] key : OSC section
 [MIX/MIX] key : Prog Mixer section
 [FLT/ZONE] key : Filter section
 [AMP/PITCH] key : AMP (Amplifire) section
 [EG/MIDI] key : EG section
 [LFO/CTRL] key : LFO section
 [FX/FX] key : Prog Fx (Effect) section
 [CMN/CMN] key : Prog Common section

OSC/TIMB MIX/MIX FLT/ZONE AMP/PITCH



EG/MIDI LFO/CTRL FX/FX CMN/CMN



MultiSet Edit mode

- ① In MultiSet Play mode, select the MultiSet that you wish to edit. (Refer to "Playing a MultiSet.") If you wish to start editing from an initialized state, refer to "Initializing settings (Init)".
- ② To select the desired section of MultiSet Edit mode, press the appropriate section key to make the LED light. (The [MULTI] key LED will blink.)

[OSC/TIMB] key : Timbre section
 [MIX/MIX] key : Multi Mixer section
 [FLT/ZONE] key : Filter section
 [AMP/PITCH] key : Pitch section
 [EG/MIDI] key : Multi MIDI section
 [LFO/CTRL] key : Ctrl Fltr (Controller Filter) section
 [FX/FX] key : Multi Fx (Effect) section
 [CMN/CMN] key : Multi Common section

Arpeggio mode

- ① In Program Play mode or MultiSet Play mode, select the arpeggio pattern that you wish to edit. (Refer to "Selecting an arpeggio pattern.")
- ② Press the [ARPEGGIO] key to enter Arpeggio mode. (The LED will blink.)

MIDI mode

- ◇ Press the [MIDI] key to enter MIDI mode. (The LED will blink.)

Global mode

- ◇ Press the [GLOBAL] key to enter Global mode. (The LED will blink.)

ARPEGGIO MIDI GLOBAL CO



□ Select a page

Select the page that you wish to edit. There are two ways to do this.

- ◇ Press the [◀] key or the [▶] key to select a page.
- ◇ Press the [JUMP] key (the LED will blink) to access a page menu in the lower part of the LCD. Then press the desired knob [1] to [5] to make your selection. (Example: Program Edit mode)

PAGE/USER GROUP



DEMO



JUMP TAB



MENU

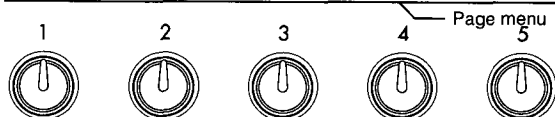

Some pages of Program Play mode are further divided using "tabs." These can be selected in two ways.

- ◇ Press the [◀] key or the [▶] key to select a page.
- ◇ Press the [TAB] key (the LED will blink), and the tab menu for that section will appear in the lower part of the LCD. Then press the desired knob [1] to [5] to make your selection. (Example: Program Edit mode)

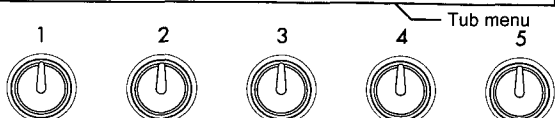

□ Moving the cursor

In Program Edit mode, MultiSet Edit mode, Arpeggio mode, MIDI mode and Global mode, two or more parameters will be shown simultaneously in the LCD. If you wish to modify the value of a parameter, you will need to move the cursor to the desired parameter. Use the CURSOR [▼] and [▲] keys and knobs [1] to [5] to move the cursor.

Moving the cursor vertically

- Press the CURSOR [▼] key or [▲] key, and the cursor will move upward or downward.

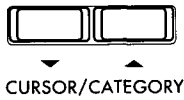

- When you press a knob [1] to [5] that corresponds to the currently-selected parameter, the cursor will move downward.

Moving the cursor horizontally

- When you press a knob [1] to [5], the cursor will move to the corresponding parameter on the line where the cursor is located.
- When you rotate a knob [1] to [5], the cursor will move to the parameter which corresponds to the knob which was rotated, allowing you to modify the value of that parameter.

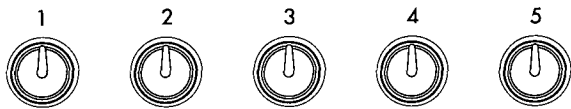

Other list-type pages

Some edit pages display lists for editing. List-type pages include the following.

- MIDI Multi Map page •MIDI CChg Filter page
- CMN Mod. Src List page •MIDI Prog Map page

In these pages, knob [1] (↑ List ↓) will scroll the list. Even in this case, you can still move the cursor vertically in the same way as described above in "Moving vertically."

Inputting values

There are several ways in which a value can be input for the parameter highlighted by the cursor. Use the method that is most appropriate for the range of settings or the display format of the parameter that is being set.

- You can rotate a knob [1] to [5] to modify the value.
- You can press the [+] key or [-] key to modify the value. The value will increase or decrease in steps of one. If you continue holding the key the value will continue to change. This is a good method for adjusting a parameter that has a narrow range of settings, or for making fine adjustments to a parameter that has a wide range of settings.

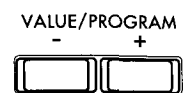

- You can use the numeric keys [0] to [9] to enter a value. Even for parameters whose value is not a number, the numeric keys can be used to enter a value that corresponds to the number you entered.

Enter numerals beginning with the highest place. The number of key presses required to finalize a value will depend on the range of the individual parameter (0 to 9 or 000 to 127 etc.). If the setting is not yet finalized even though you have entered the desired number, press the [ENTER] key to finalize it.

If the number that you entered would exceed the maximum value of the parameter, the maximum value will be entered. If it would exceed the minimum value, the minimum value will be entered. If the range of possible values is discontinuous, the next lowest number that is a valid setting for that parameter will be entered.

- To input a negative (-) sign, press the [-/ 10's HOLD] key. Thereafter, subsequent presses will switch the sign of the number between positive and negative. Press the [ENTER] key to finalize the value.

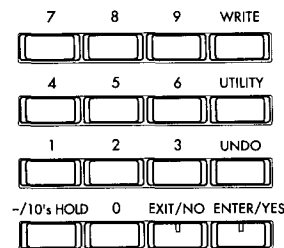

- You can press a note on the keyboard to enter a value. For parameters whose value is a note name (C to B, or C-1 to G9), or parameters related to key velocity, hold down the corresponding knob and play a note on the keyboard to enter that note name or velocity as the setting.

In this case, the note number will not be affected by the "Transpose" setting (GLB Basic page) or the octave up/down setting.

Parameters that require you to press the [ENTER] key

For some parameters, you must press the [ENTER] key to validate the setting after using one of the above methods to specify the value.



Saving the modified settings

After you have finished editing, you can save the changes that you have made. Refer to "Saving data."

4. Program editing (Program Edit mode)

Although you can use the realtime editor or performance editor to edit the sound while you are still in Program Play mode, there are limitations on the parameters which can be edited.

In Program Edit mode you can freely edit all parameters, either to modify the sound of an existing program or to create a completely new sound.

After editing program parameters, you will need to execute the Write operation (see p.26) if you wish to keep your edits.

How a Program is organized

The Z1's programs are organized as follows.

OSC (Oscillator) section

This section is where the basic waveform of the sound is produced.

Oscillator 1/2

Thirteen types of tone generator (oscillator type) are provided. You can combine two of these oscillator types, and make settings to specify the basic pitch and other aspects of the sound. However some oscillator types can be used only by themselves.

Sub Oscillator

You can select one of four types of basic waveform. Pitch-related settings can be made in the same way as for OSC 1/2.

Noise Generator

This produces white noise. The white noise can be sent through a multi-mode filter (low pass filter, high pass filter, band pass filter).

Prog Mixer section

Here, the signals from oscillator 1/2, the sub oscillator, and noise generator are mixed with the feedback from the AMP section, and output to multi-mode filters 1 and 2 (the Filter section).

Filter section

This section processes the waveform by attenuating or boosting specific frequency regions of the sound. Two multi-mode filters are provided. You can specify the type of each filter (low pass filter, high pass filter, band pass filter, band reject filter, dual band pass filter). This section allows you to modify the brightness of the sound. You can also specify how the two filters, the MIXER section and the AMP section will be connected.

AMP (Amplifier) section

This section creates time-varying changes in the volume that is output from the FILTER section. Two independent amps are provided. The signal that is input to each amp will depend on the way in which connections have been made in the filter section.

The AMP section also provides amp envelope generators (Amp EG) that can be used to control the amps.

Prog Fx (Effect) section

This section applies effects to the signal that is output from the AMP section. Effect units 1 and 2 provide fifteen types of effect including modulation-type effects and exciter. The master effect unit provides delay, hall reverb, or room reverb. A two-band EQ is also provided in this section. Each effect unit (effect units 1 and 2, and the master effect unit) can produce one type of effect at a time.

EG section

This section contains four general-purpose envelope generators (EG). The four EGs of the EG section can be used as modulation sources for the parameters of other sections, in order to create time-varying changes in the sound.

LFO section

This section contains four general-purpose LFOs. The four LFOs of the LFO section can be used as modulation sources for the parameters of other sections, in order to create cyclic changes in the sound.

Prog Common section

The Prog Common section is where you assign a name to the program, and specify the function of the keyboard and controllers (knobs [1] to [5], [X-Y PAD] etc.).

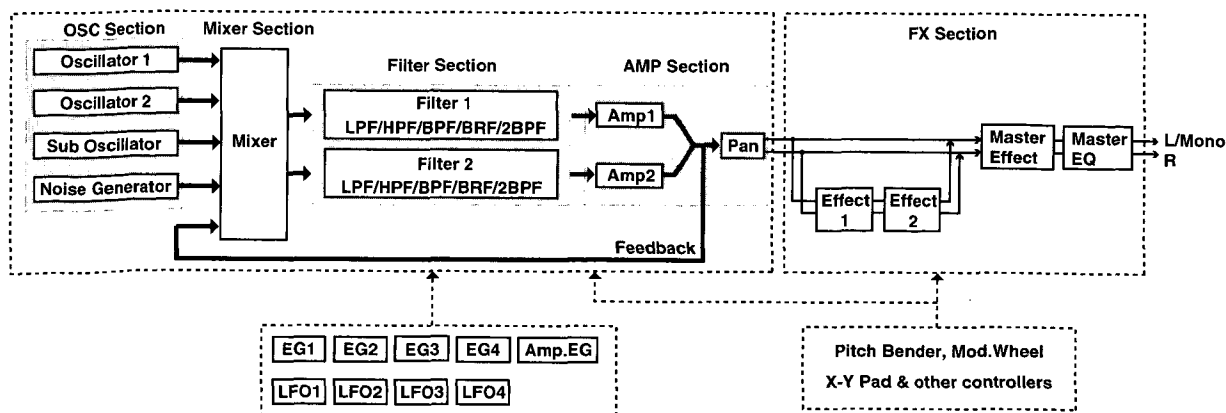

□ Filter settings (Filter section)

The filter attenuates or boosts specific frequency regions of the sound produced by the oscillator, thus making the sound brighter or darker. Filter settings can make dramatic differences in the tone.

The Z1 provides two filters, each of which can be used as one of five filter types. The characteristics of each filter can be modified freely, allowing a wide range of tonal changes to be created.

This section will provide a simple explanation of what the filter does.

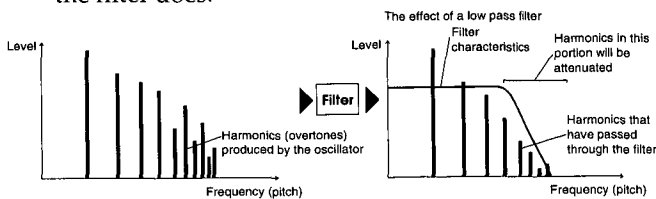

- ① Enter Program Play mode, and select the program number that you wish to edit. (Refer to "Playing a program.")
- ② Press the [FLT] key (the LED will light) to access the Filter section.



- ③ Press the [JUMP] key, and then press knob [1] (Route) to access the Filter Routing page.

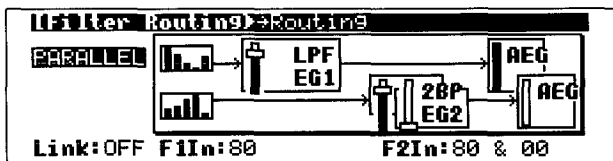

- ④ Press knob [1] several times to move the cursor to "Routing" (this will indicate either SERIAL1, SERIAL2, or PARALLEL).
- ⑤ Either press knob [1] to specify the routing. On the Z1, the way in which the two filters are connected is referred to as the routing. This setting will also determine the way in which the mixer → filter → amp are connected. There are three selections for routing: "Serial1," "Serial2" and "Parallel" (see p.52).
- ⑥ In this example we will check the setting of filter 1. Press the [JUMP] key, and then press knob [2] to move to the Filter1 page (you may also use the [▶] key).

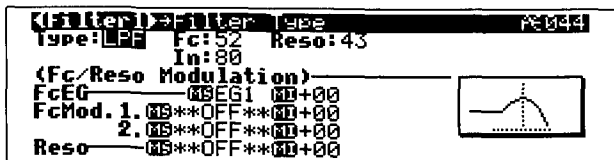

- ⑦ Press knob [1] to move the cursor to "Filter Type." Either by rotating knob [1] or by pressing the [+] or [-] key, set the filter type to one of the following choices: **LPF** (low pass filter), **HPF** (high pass filter), **BPF** (band pass filter), **BRF** (band reject filter), or **2BPF** (dual band pass filter). Then press the [ENTER] key. Notice how changing the filter type has affected the sound (see p.53).

- ⑧ Press knob [2] to move the cursor to "Fc (Cutoff Frequency)." Rotate knob [2] to modify the setting, and the brightness of the sound will change. For example if you have selected the **LPF** ("Filter Type") that is frequently used with synthesizers, higher values will cause the sound to be brighter, and lower values will cause the sound to be darker. This is because the upper frequency limit (cutoff frequency) of the sound that passes through the filter is being modified. This value can also be controlled in Program Play mode by rotating the Filter 1 knob [CUTOFF].

- ⑨ Press knob [3] to move the cursor to "Reso (Resonance)." Rotate knob [3] to modify the value, and notice that the tone takes on a unique character. This is because the frequency range surrounding the area of the cutoff frequency is being boosted (see p.53). This value can also be controlled in Program Play mode by rotating the Filter 1 knob [RESONANCE].

- ⑩ You can use a modulation source (see p.19) to control the cutoff frequency or resonance. Rotate knob [2] to lower the "Fc (Cutoff Frequency)" value (to about 10). Press knob [2] twice to move the cursor to "FcEG-**EG**" (Cutoff Frequency Mod. EG Source). Either rotate knob [2] or press the [+] key or [-] key to select an EG which will create time-variant change in the cutoff frequency. Next rotate knob [3] to raise the "FcEG-**INT**" (Cutoff Frequency Mod. EG Intensity)" value (to about 90). Play the keyboard and notice how the cutoff frequency changes over time. This value can also be controlled in Program Play mode by rotating the Filter 1 knob [EG INT].

- ⑪ You can make settings for the EG (EG 1 to 4, amp EG) that will vary the cutoff frequency. For example, the sound of a piano note is bright at the moment that the note is played, and then gradually becomes darker (more mellow). Depending on how it is played, a violin allows the tone of a note to be varied during the duration of the note. Settings for EG1 to 4 are made in the EG section. Settings for the amp EG are made in the AMP section. In this example we will make settings for EG1. Set "FcEG-**EG**" to EG1.

- ⑫ Press the [EG] key to move to the EG section.

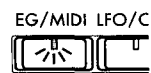

- ⑬ Press the [JUMP] key, and then press knob [1] (EG1) to access the EG1 page.

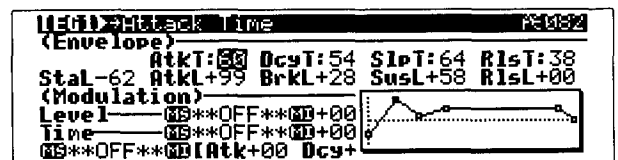

- ⑭ Use the [▼] key or the [▲] key, or knobs [1] to [5] to modify the values of "AtkT (Attack Time)," "DcyT (Decay Time)," "SlpT (Slope Time)," "RlsT (Release Time)," "StaL (Start Level)," "AtkL (Attack Level)," "BrkL (Break Level)," "SusL (Sustain Level)" and "RlsL (Release Level)." Play the keyboard and notice the result

of the changes you have made. For an explanation of each parameter, refer to p.57. These values can also be controlled in Program Play mode by rotating the various Filter EG knobs.

❑ Amp settings (AMP section)

The amp creates time-variant change in the volume. The time-variant change we are speaking of here is change such as "a rapid attack after a note is struck" or "a gradual decay." For example a note played on a piano reaches its maximum volume immediately, and then gradually decays to silence. A note played on an organ will maintain the same volume until it is released. Depending on the playing technique, the volume of a note played on a violin can be varied while the note continues to sound. It is the role of the AMP section to control this type of volume change.

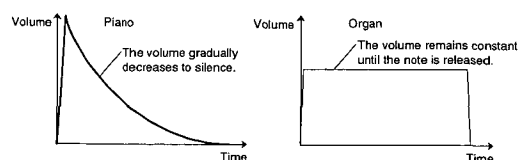

- Press the [AMP] key (the LED will light) to access the AMP section.



- Press the [JUMP] key, and then press knob [1] (Amp 1/2) to access the Amplitude page.

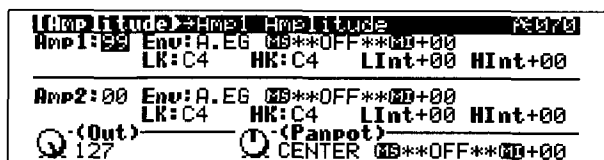

- Press knob [2] several times to move the cursor to the "Env (Amp1 Amp Mod.EG)", and then rotate knob [2] to select one of the EGs. In this example we will select A.EG.
- Press the [▶] key to access the AmpEG page.

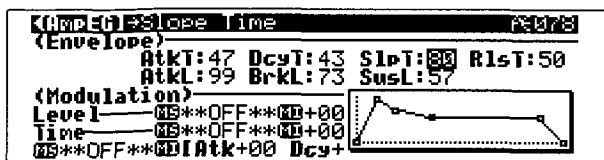

- Press knob [2] several times to move the cursor to the "AtkL (Attack Level)" line, and rotate knob [2] to raise the "AtkL (Attack Level)" setting to 99. This will cause the attack to reach the maximum volume. Press the [▲] key, and then rotate knob [2] to modify the "AtkT (Attack Time)" value. Play the keyboard and notice how the attack changes.
- Go on and try modifying the values of "DcyT (Decay Time)," "SlpT (Slope Time)," "RlsT (Release Time)," "BrkL (Break Level)," and "SusL (Sustain Level)," and notice the result. For an explanation of these param-

eters, refer to p.55. These values can also be controlled in Program Play mode by rotating the various AMP ENVELOPE knobs.

- The AMP section Amplitude page also contains settings such as "Output Level" which determines the output volume and "Panpot" which determines the stereo location (pan) of the signal that is sent to the effects (discussed in the following section).

❑ Effect settings (Prog Fx section)

The Prog Fx (effects) section contains three effect units: Effect 1 (Fx1), Effect 2 (Fx2), and the Master Effect (Mst.Fx).

The sound produced by the OSC, MIXER, FILTER and AMP sections is processed by these effects. Fx1 and Fx2 can respectively apply one of 15 different types of effect. Mst.Fx can apply one of three types of reverb-type effect. The sound is then sent through the Mst.EQ for final adjustment.

Effect 1 (Fx1) / Effect 2 (Fx2)

Fx1 and Fx2 are normally used as part of the sound-creating process. Fifteen different effects can be selected, including effects such as overdrive, equalizer, compressor and exciter which modify the tone or dynamics, effects such as rotary speaker which help create the character of a particular instrument, and effects such as chorus and delay which add spaciousness or reverberation. Up to two effects can be connected in series. However if either Talking Modulator, Multitap Delay, Ensemble or Rotary Speaker (L) is selected for Fx1, only one of these effects can be used.

Master effect (Mst.Fx)

The master effect is normally used to perform sound field processing for the entire program.

You can select one of three sound-field effects: delay, hall reverb or room reverb.

A Low/High type shelving EQ is also provided before the L/MONO and R outputs. This allows you to make final adjustments to the tone.

Effect input and output

The input level to each of the Fx1, Fx2 and Mst.Fx effects is specified by "Effect Send," relative to the output level of the AMP section "Output Level." In addition, "Fx Balance" adjusts the balance between the sound processed by the effect and the unprocessed sound. The Fx1 and Fx2 effects Overdrive to Rotary Speaker (S) will output the processed sound in monoaural, and the Fx1 Talking Modulator to Rotary Speaker (L) effects will output the processed sound in stereo. In either case, the unprocessed sound is output according to the "Panpot" setting from the AMP section. Master Effect combines the Fx1, Fx2 and unprocessed sound and outputs it in stereo.

Each effect can be switched on/off using [SW1], [SW2] or ASSIGNABLE SW (see p.62). If each "Fx SW" parameter is switched OFF, the effect will be bypassed.

It is also possible to specify that the master effect will always be bypassed (see p.94).

- ① Press the [FX] key (the LED will light) to access the Prog Fx section.

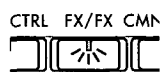

- ② Press the [JUMP] key, and then press knob [1] (Set Up) to access the Effect Set Up page (see p.59).

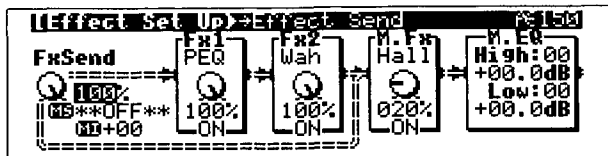

- ③ Press knob [1] several times to move the cursor to "Effect send."
- ④ Either rotate knob [1] or press the [+] or [-] key to set the balance between the level that will be sent to Fx1 and Fx2, and the level that will be sent to Mst.Fx. Raising the % will increase the level that is sent to Fx1 and Fx2.
- ⑤ Either rotate knob [2] or press the [+] or [-] key to select the effect type that will be used by Fx1. For details on each type, refer to p.64 to 74. After making your selection, press the [ENTER] key to execute.
- ⑥ Press the [▼] key to increase the "Fx1 Balance" setting, so that the effect sound will be prominent in the balance between the processed sound and the direct sound.
- ⑦ In order to use the effect, make sure that the "Fx1 SW" is ON.
- ⑧ In the same way as in steps ⑤ to ⑦, use knob [3] to make settings for Fx2, and use knob [4] to make settings for Mst.Fx. You can use knob [5] to adjust the Mst.EQ.
- ⑨ Press the [JUMP] key, then press a knob [2] to [5] to select the effect (or EQ) that you wish to edit, and make settings for the various parameters. For details refer to p.64 to 76.

□ Oscillator settings (OSC section)

The oscillator section produces the waveform, which is the most important factor that determines the tone. One way to edit a program is to start with a program that is close to the desired sound. However when creating a sound from scratch, you will normally decide on the oscillator type before moving to the other sections to complete the sound.

- ① Enter Program Play mode, and select the program number that you wish to use as the basis for the program that you will create (refer to "Playing a program"). If you wish to begin editing from an initialized state, refer to "Initializing settings (Init)" (see p.28).
- ② Press the [OSC] key (the LED will light) to access the OSC section.



- ③ Press the [JUMP] key, and then press knob [1] (Set Up) to access the OSC Set Up page.



- ④ Press knob [1] several times to move the cursor to "OSC1 (OSC Type)."
- ⑤ Either rotate knob [1] or press the [+] or [-] key to select the oscillator type. After selecting the oscillator type, press the [ENTER] key to execute.

01: Standard OSC

This simulates the oscillator of an analog synthesizer. It can produce the same effects as an analog synthesizer, such as pulse width modulation (see p.32).

02: Comb Filter OSC

This oscillator creates pitched sound from noise or an impulse. It can create a wide variety of sounds — not only noisy sounds, but also sounds ranging from synth-bass to strings (see p.34).

03: VPM OSC (Variable Phase Modulation OSC)

This oscillator uses phase modulation to create overtones. By modulating the phase of two oscillators and using a wave shaping table to process the sound, rich overtones can be produced (see p.36).

04: Resonance OSC

This oscillator uses four tunable filters which are set up in series. Noise is input through the filter bank for very ethereal sounds (see p.37).

05: Ring Modulation OSC

06: Cross Modulation OSC

07: Sync Modulation OSC (oscillator sync)

These are special oscillators which simulate the effect of two oscillators which are used to modulate each other, which was a technique that was possible on analog synthesizers. These are especially suitable for producing sounds that are rich in overtones, such as bells, metallic sounds or gongs (see p.39, p.40).

08: Organ Model

This simulates a drawbar organ with three drawbars (when one oscillator is used) or six drawbars (when two oscillators are used) (see p.40). Since each drawbar can use one of four types of waveform, a wide range of tones can be produced.

09: Electric Piano Model

This is a physical model which simulates a warm, vintage electric piano sound (see p.41).

10: Brass Model

This is a physical model which simulates a brass instrument such as a trumpet or trombone (see p.42).

11: Reed Model

This is a physical model which simulates a wind instrument such as a saxophone or flute (see p.44).

12: Plucked String Model

This is a physical model which simulates a plucked string instrument such as a guitar or bass guitar (see p.45).

13: Bowed String Model

This is a physical model which simulates a bowed string instrument (see p.48).

On the Z1, you can select one of 13 types of oscillator for OSC1. If an oscillator type 1 to 9 is selected for OSC1, you will also be able to select an oscillator type 1 to 9 for OSC2. In addition, you can add the sub-oscillator and noise generator to create the desired sound. Here we will be giving a simple example using the Standard OSC. For details refer to the explanations on p.32 to 34.

Select 01:Standard_OSC for OSC1, and press the [ENTER] key.

- ⑥ Press the [▶] key to access the OSC1 page. In this page you can make settings for the oscillator that was selected in the OSC Set Up page "OSC1 (OSC Type)." The parameters in this page are further grouped into several tabs. In the first tab you can specify the basic pitch of the oscillator. Move the cursor to the "Oct" line, and rotate knobs [1] to [4] to specify the basic pitch.
- Press the [▼] key to move to the "MS" and "MD" line, and you can specify a modulation source and modulation intensity that will control the pitch.

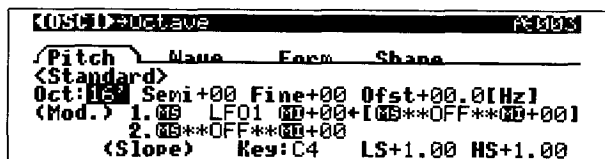

- ⑦ Press the [TAB] key to move to the desired tab page. Press knob [2] (Wave) to move to the Wave Select page.

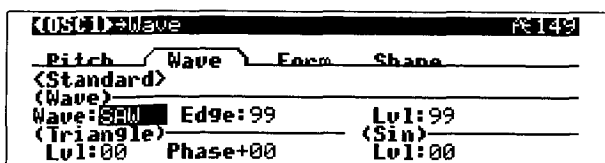

- ⑧ Press the [▼] or [▲] key to move the cursor to the "Wave (Wave Select)" line.
- ⑨ Rotate knob [1] to modify the value of "Wave (Wave Select)." Play the keyboard, and notice how the sound changes depending on whether the sawtooth (SAW) or the pulse (PULSE) waveform is selected.
- ⑩ Press the [▶] key to move to the Wave Form page.

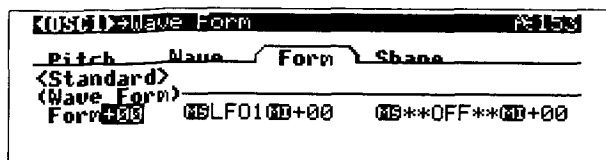

- ⑪ Rotate knob [3] to modify the value of "Wave Form Mod.LFO Intensity," and the way in which the sound is being modulated will change. This parameter adjusts the width of the LFO waveform selected by "Wave Form Mod.LFO" that is modulating the amplitude of the "Wave Select" waveform.
- ⑫ The LFO (1 to 4) settings that you heard in step ⑪ can be adjusted in the LFO section. Press the [LFO] key to move to the LFO section, and modify the parameters of the LFO that you selected for "Wave Form Mod.LFO."

□ Adjusting the volume of each oscillator (Prog Mixer section)

- ✦ Press the [MIX] key (the LED will light) to access the Prog Mixer section. Here you can adjust the balance between the output volumes of oscillators 1 and 2, the sub-oscillator, the noise generator, and of the feedback from the amp section. These settings will determine the signal levels that are sent to the multi-mode filters 1 and 2 (the Filter section) (see p.51).

MIX MIX/MIX FLT.

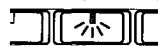

□ About keyboard tracking

Keyboard tracking refers to the way in which the keyboard location can modify aspects of the sound such as pitch, tone and volume. Keyboard tracking is used mainly to compensate for irregularities in pitch, tone or volume which may occur when a sound is played over a wide range of pitches.

□ EG and LFO (EG/LFO section)

An EG (Envelope Generator) applies time-variant change to a parameter, causing the pitch, tone or volume to change.

An LFO (Low Frequency Oscillator) applies cyclic change to a parameter. Using an LFO to cyclically modulate the pitch will produce the effect known as vibrato, which is often heard in a vocal or string instrument performance. Cyclically modulating the tone will produce a wah effect, which you have probably heard used by a muted trumpet or by an electric guitarist playing through a wah pedal. Cyclically modulating the volume will produce a tremolo effect, often heard on electric piano or electric guitar.

□ Modulation sources and intensity

The Z1 has various modulation source (Mod.Source) and modulation intensity (Mod.Intensity) parameters. During editing, these parameters are indicated in the LCD as "MS" and "MD."

Modulation sources are control sources which can be used to control a specified parameter. For the tone generator section you can select from 48 modulation sources, and for the effect section you can select from

35 modulation sources (see p.104). You can also control the sound by using an EG or LFO (tone generator section only), and by using controllers such as aftertouch, the [MOD WHEEL] or the [X-Y PAD] while you play.

Modulation intensity determines the depth and direction of the control that the modulation source will perform. Since some parameters can have more than one modulation source and intensity, the sound can be controlled in highly complex ways.

As an example, let's use the [X-Y PAD] to control the effect balance amount.

- ① Refer to "Effect settings (Prog Fx section)" steps ① to ④, and set the "Effect Send" to 10%.
- ② Press knob [1], and then press numeric keys [2], then [4], then the [ENTER] key to set "Effect Send Mod.Source" to X[+].
- ③ Press knob [1], and then rotate knob [1] to set "Effect Send Mod.Intensity" to +50.

In this example, the normal effect balance will be 10%, and when you move your finger on the [X-Y PAD] (from the center) toward the right, the proportion of the effect will gradually increase, and will reach the maximum when you reach the right edge of the pad. At this time, the effect balance will be 60%. When the modulation source is at maximum, the actual value of the parameter will be the "parameter value" + the "Mod.Intensity" value.

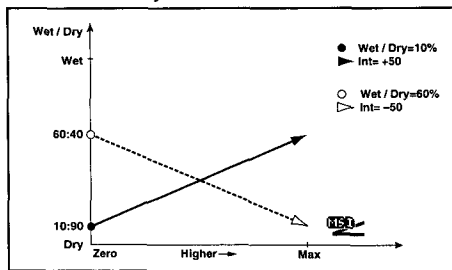

Setting and checking the modulation source

You can view a list of the parameters to which a modulation source is assigned, and check or modify the modulation source (see p.62).

□ Performance editor assignments

For each program, you can assign program parameters to knobs [1] to [5], so that the sound can be modified by rotating the knobs. Four program parameters can be assigned to each knob.

- ① Press the [CMN] key (the LED will light) to access the Prog Common section.

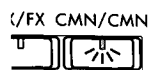

- ② Press the [JUMP] key, and then press knob [4] (PE Def) to access the CMN PE Define page. The display will show the parameters which can be assigned to each

knob and the upper and lower limits of their range. To specify parameters for assignment to another knob [1] to [5], press the [TAB] key, then press the knob for which you wish to make the assignment, and then make the desired setting.

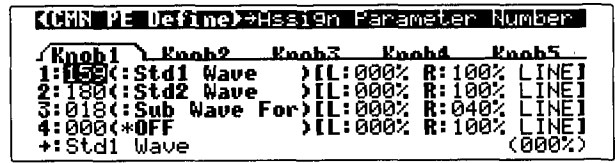

- ③ Rotate knob [1], and the available parameters will be displayed successively. Here you can select the parameters to be assigned to each knob ([1] to [5]).
- ④ Rotate knob [3], and specify the parameter value that will be in effect when the knob ([1] to [5]) is rotated far left in Program Play mode (or MultiSet Play mode). Try different settings while listening to the result. The displayed value indicates the percentage relative to the Program Edit mode setting. Knob [4] specifies the sound that will result when the knob is rotated far right. Set the value in the same way as described above. If you press knob [1] and return to the "Assign Parameter" that you checked in step ③, you will notice that the sound has changed. This is because the assigned parameter will return to the value of its setting.
- ⑤ Knob [5] ("LINER") allows you to choose one of four curves by which the sound will change when the knob ([1] to [5]) specified in step ④ is operated (see p.63).

Using the UTILITY function to make settings

When you move the cursor to the parameters of the various pages (the display will be highlighted), a PE number may be displayed in the upper right of the LCD. At this time, you can register this parameter in the performance editor.

- ① Press the [UTILITY] key.



- ② Press knob [2] (PE Def), and the utility menu will appear.
- ③ Rotate knob [2] to select the knob for which you wish to make a performance editor assignment.
- ④ Press the [ENTER] key. The cursor will move to the performance editor knob that you specified in step ③ for Prog Common section CME PE Define page step.
- ⑤ Refer to steps ④ to ⑤ of "Performance editor assignments," above, and make performance editor settings.
- ⑥ When you finish making settings, press the [UTILITY] key, and then press knob [2] (Return) to return to the location where you had been editing.

5. Editing a MultiSet (MultiSet Edit mode)

In MultiSet Edit mode, you can combine up to 6 programs (without their effect settings), and make settings for volume and pan (stereo location), effect send level, keyboard area and velocity range, and restrictions on MIDI message control for each program.

After editing parameters, you will need to execute the Write operation (see p.26) if you wish to keep your edits.

Be aware that if the programs assigned to a MultiSet are modified in Program Edit mode, the sound of the MultiSet will also change.

How a MultiSet is organized

On the Z1, a MultiSet is organized as shown in the following diagram.

Multi TIMB (Timbre) section

Specify a program for each of the six timbres (Timbre 1 to 6), and specify the maximum number of notes for each timbre.

Multi MIX (Mixer) section

For each timbre, adjust the level, panpot, and effect balance.

Multi Zone section

For each timbre, specify the keyboard range and velocity range. The settings in this section allow you create layered, split, and velocity-switched MultiSets.

Multi Pitch section

For each timbre, specify the scale, transpose setting, and detune setting. The timbre played by the arpeggiator can also be specified here.

Multi MIDI section

Specify the MIDI channel for each timbre. You can also specify whether or not external MIDI program changes will be received. When you wish to control the Z1 from an external MIDI device and use the Z1 as a multi-timbral tone generator of up to 6 channels, specify the MIDI channels in this section.

Multi CTRL (Control Filter) section

For each timbre, you can specify whether or not each type of controller and MIDI message will be received or ignored. You can also specify that the pitch bend width of the program used by each timbre be set to a unified pitch bend width.

Multi Fx (Effect) section

You can make programmable multi-effect settings in the same way as for a program. The settings of effect units 1 and 2 are adjusted for each timbre by the Multi MIX section Effect Balance parameter.

Multi CMN (Common) section

Specify the name of the MultiSet, pitch bend settings used only for the MultiSet, scale type, and the function of the assignable switches.

Selecting the Timbre Programs

- Enter MultiSet Play mode, and select the MultiSet number that will be the basis for the MultiSet that you wish to create (refer to "Playing a MultiSet"). If you wish to begin editing from an initialized state, refer to "Initializing the settings (Init)."
- Press the [TIMB] key (the LED will light) to access the Multi Timbre section.

OSC/TIMB MIX/M



Timbre	Bank	Num	Program Name
T1: 04	000	040	(Trumpet)
T2: 04	000	044	(Tb-202 xy)
T3: 04	000	042	(Brass Ens1)
T4: OFF	000	000	(Giant REZ Sweep!)
T5: OFF	000	000	(Giant REZ Sweep!)
T6: OFF	000	000	(Giant REZ Sweep!)

- Press the [▼] or [▲] key to select the timbre to which you wish to assign a program.
- Press knob [1] and specify the maximum number of simultaneous notes for that timbre. The upper right of the LCD will indicate "VoiceReserve (Total=*/12 [or 18])." The area of "*" indicates the total number of notes for each timbre, and "12 (or 18)" indicates the maximum simultaneous note capacity of the Z1. It is not possible to specify a number of maximum simultaneous notes that would exceed this total. Either rotate knob [1] or press the [+] or [-] key to input the value, and then press the [ENTER] key to confirm the setting.
- Use knob [2] to specify the program bank. Input the value by either rotating knob [2] or by pressing the [+] or [-] key, and then press the [ENTER] key to finalize the value.
- Use knob [3] to specify the program number. Input the value by either rotating knob [3] or by pressing the [+] or [-] key, and then press the [ENTER] key to finalize the value. You can also use the numeric keys for input.

Only internal programs can be used by an internal MultiSet. Even if a card is inserted, card programs cannot be used. Similarly, card MultiSets cannot use internal programs.

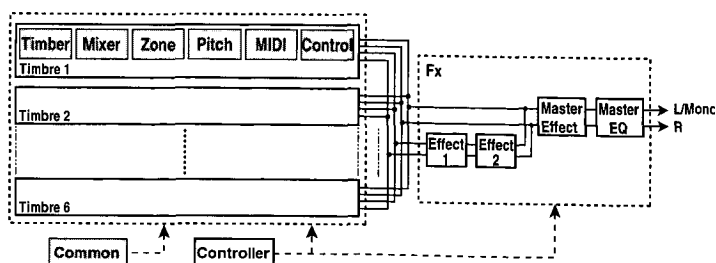

□ Adjusting the volume, pan, and effect amount

- ① Press the [MIX] key (the LED will light) to access the Multi Mixer section.

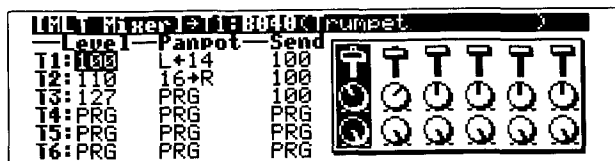

- ② Use knob [1] to adjust the volume for each timbre of the MultiSet, and use knob [2] to adjust the panpot (stereo location). As you modify these values, the overall volume balance and panning will change. Use knob [3] to specify the amount of panning of the signal of each timbre that will be sent to the effects. If any setting is set to a value of PRG, the volume, panpot and effect balance settings of the assigned program will be used (see p.77).

□ Specifying the way in which different keyboard areas or playing strengths will be sounded

- ① Press the [ZONE] key (the LED will light) to access the Multi Zone section.

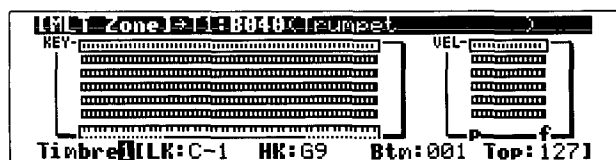

- ② Rotate knob [1] to select the timbre for which you wish to make keyboard zone and velocity zone settings.
- ③ While pressing knob [2], play a note on the keyboard and that note will be specified as the lowest note for which the selected timbre will sound. In the same way, hold down knob [3] and play a note on the keyboard to specify the highest note for which the selected timbre will sound. You can also specify these settings by rotating knob [2] or knob [3], or by pressing the [+] or [-] key.

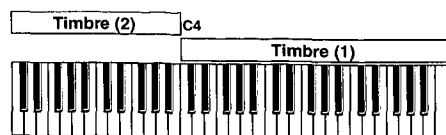

By specifying the keyboard area in this way, you can create split-type MultiSets in which (as shown in the diagram) the electric piano program that is assigned to timbre (1) will play only in the area from C4 and above, and the bass program that is assigned to timbre (2) will play only in the area of B3 and below.

- ④ Hold down knob [4] and play a note, and the velocity (strength) at which you played the note will be entered as the lowest velocity for which the selected timbre will sound. In the same way, hold down knob [5] and play a note to specify the highest velocity which will sound the timbre. You can also specify these settings by rotating knob [4] and knob [5], or by using pressing the [+] or [-] key.

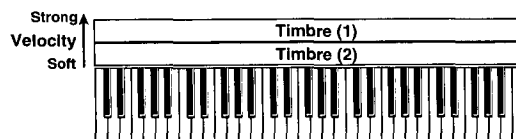

In this way, you can create a velocity-switched MultiSet in which different timbres will sound in response to notes played at different strengths.

□ Effect settings

In a MultiSet, the effect settings for each program are ignored, and the effect settings that are made in MultiSet Edit mode will be used.

Effects for a MultiSet are basically the same as effects for a program, and provide three effect units (Fx1, Fx2, and Mst.Fx). However the input section to the effects is different; "Fx Balance" will specify the level at which each timbre is sent to Fx1, Fx2 and Mst.Fx relative to the Multi Mixer section "Level" output volume.

Copying effect settings from a program or from another MultiSet

You can use a utility function to copy effect settings from a specific program or MultiSet (see p.28 and p.105).

□ Restricting the controllers or editor for each timbre

The Multi CTRL (Control Filter) section lets you specify which timbres will respond when the Z1's controllers and editors are operated or when MIDI messages are received from an external MIDI device. In the above example of a split-type MultiSet, you could make settings so that operating the [PITCH BENDER] would affect the pitch of only the bass program being played by timbre (2), and operating the damper pedal would apply the damper effect only to the piano program being played by timbre (1). For details refer to p.80.

□ Editing other MultiSet parameters

You can also vary the pitch of the timbres to create rich sounds (refer to the Multi Pitch section, p.78), and specify a different MIDI channel for each timbre so that the Z1 can be used as a multi-timbral MIDI tone generator (refer to p.79 and p.97).

6. Arpeggio editing (Arpeggio mode)

In Arpeggio mode you can make settings which determine the basic operation of the arpeggiator. For the preset patterns, you can specify the resolution, and the velocity and duration of the notes in the arpeggio. User patterns allow you to create arpeggio patterns of up to 36 steps.

⚠ If after editing the parameters of an arpeggio pattern, you wish to keep the modified settings, you must perform the Write procedure (see p.26) while still in Arpeggio mode. If you re-select the arpeggio pattern without saving, your edits will be lost.

- 1 In a mode other than Arpeggio mode, use the [PRESET/USER] key and the PATTERN SELECT [UP] key to select the UP pattern.

PRESET	UP	DOWN	ALT1	ALT2	RANDOM
○ USER1	U1-1	U1-2	U1-3	U1-4	U1-5
○ USER2	U2-1	U2-2	U2-3	U2-4	U2-5
○ USER3	U3-1	U3-2	U3-3	U3-4	U3-5

- 2 Press the [ARPEGGIO] key (the LED will blink) to enter Arpeggio mode.



- 3 Make sure that "Sort" is ON. This indicates that when the arpeggio is played, notes will be played beginning from the lowest-pitched note (i.e., "sorted"). When this function is on, you will notice that the arpeggio is repeated from the lowest note to the highest note. Press knob [1] several times to move to the "Sort". Rotate knob [1] to turn "Sort" OFF, and try playing the keyboard. The notes of the arpeggio will be sounded in the order that you played them.

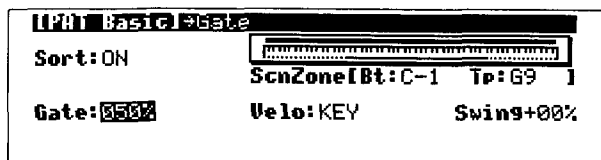

When Arpeggio Pattern is UP



If you pressed keys in the order of C4 → G4 → E4 → B4 ...



Sort : ON



Sort : OFF



- 4 Press knob [1] to move to "Gate." This indicates the duration (gate time) of each arpeggio note as a percentage of the note value selected by [RESOLUTION] knob. If the knob [GATE] is at 12 o'clock, arpeggio notes will be sounded with the same duration as the [RESOLUTION] setting. Try changing the "Gate" value and adjusting the knob [GATE] to hear the result.
- 5 Press knob [3] to move to "Velo." Rotate knob [3] to set this to KEY. With this setting, the notes of the arpeggio will be sounded at the velocity that you played. Play notes at different strengths, and notice how the resulting arpeggio changes. If you rotate knob [3] to change the value to 001 to 127, the notes of the arpeggio will be sounded at the fixed velocity that you specify, regardless of the strength at which you played them. When the [VELOCITY] knob is in the 12 o'clock position, notes will be sounded with the velocity that you specify here. Try changing the "Velo" value and moving the [VELOCITY] knob, and listen to the result.
- 6 Press the [▲] key to move to "ScanZone Bottom/Top." Specify the range of the keyboard in which the arpeggiator will function. You can also specify the range by playing a note on the keyboard while you hold down knob [4] or knob [5].

□ Creating a user pattern

Here let's create the arpeggio pattern shown in the musical example below.



- 1 Rotate the [RESOLUTION] knob to the 8th note setting.
- 2 In a mode other than Arpeggio mode, use the [PRESET/USER PATTERN] key and the [PATTERN SELECT] key to select a user pattern. Press the [ARPEGGIO] key (the LED will blink) to enter Arpeggio mode. If an arpeggio is playing, press the ARPEGGIATOR [ON/OFF] key (the LED will go dark) to turn it off.
- 3 Press the [JUMP] key, and then move to knob [1] and turn "Sort" ON.
- 4 Rotate knob [1] to set "Gate" to STEP, and rotate knob [3] to set "Velocity" to STEP. With these settings, the length and velocity of each arpeggio note will be the same as specified by each step. Also set "Swing" to 00%. For details refer to p.83.
- 5 Now specify the length of the pattern. In the musical example given above, there are eight 8th notes, so press the [▼] key and then rotate knob [1] to set "Length" to 08. Next rotate the appropriate knobs to set "Type" to As_Played, and "Oct" to UP.

- ⑥ Press the [▶] key to move to the PAT Step Param page. Each user pattern has up to 36 steps, and the arpeggiator will play each step in succession at the note value interval specified by the [RESOLUTION] knob. The "Stp" parameter at the left indicates the step number. Here you can specify the Tone for each step, and set step parameters such as "Pitch Offset," "Gate," "Velocity" and "Flam."

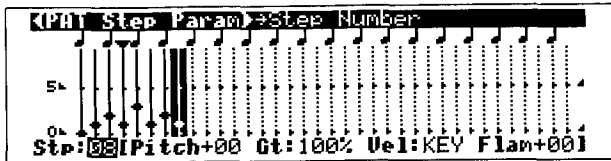

- ⑦ The "•" on the horizontal lines in the display indicate the Tone that will be played for each step. The solid line extends up to the step that was specified in "Length (PAT Basic page)," and subsequently a dotted line will be displayed. By pressing knob [1] to move the cursor to "Stp" and then using the numeric keys, you can specify the "Tone" or "Tones" that will be played by that step. Operate the numeric keys, and see how the display changes. Pressing [0] will register/erase "Tone0." "Tone0" corresponds to the lowest note that is being played on the keyboard. (When "Sort" is OFF, this will correspond to the first-played note.) In the same way, "Tone1" corresponds to the second-lowest note, and "Tone9" corresponds to the tenth-lowest note. For this example, enter the following settings according to the musical example. You can move backward or forward through the steps using the [+] or [-] keys or the [▼] or [▲] keys.
- | | | | |
|--------|-------|-------|-----|
| Stp:01 | | Tone0 | [0] |
| Stp:02 | | Tone1 | [1] |
| Stp:03 | | Tone2 | [2] |
| Stp:04 | | Tone1 | [1] |
| Stp:05 | | Tone3 | [3] |
| Stp:06 | | Tone1 | [1] |
| Stp:07 | | Tone2 | [2] |
| Stp:08 | | Tone1 | [1] |

- ⑧ Specify the "Pitch Offset," "Gate," "Velocity" and "Flam" for each step. These parameters have the following effect.

Pitch Offset: Pitch Offset: Raise or lower the scale of the arpeggio notes in semitone steps. By specifying the same tone for each step and changing the "Pitch Offset" value for each step, you can create a melody with one tone.

Gate: This is the length of the arpeggio note. With a setting of 100%, the note will last the full length of the interval specified by the [RESOLUTION] knob. With a setting of LEGT, the note will continue sounding until the next note begins or the pattern ends. With a setting of OFF, that step will not sound.

Velocity: This is the strength of the note. With a setting of KEY, the note will be sounded with the velocity at which you played the keyboard. With a setting of 001 to 127, all Tones of that step will be sounded at

the specified velocity.

Flam: This specifies how notes will be separated if two or more Tones were specified for the same step. With a setting of +00, all Tones will sound simultaneously. With positive (+) settings, notes will be separated beginning with the lowest Tone. With negative (-) settings, notes will be separated beginning with the highest Tone.

For this example, press the [▼] or [▲] key to select the step, and use knobs [1] to [5] to set parameters of Stp:01 to 08 to the following settings.

Pitch+00% Gt:80% Vel:100 Flam+00

Now press the ARPEGGIATOR [ON/OFF] key (the LED will light), and hold down the chord shown in the musical example. The arpeggio that you input will be played.

- ▲ If the length or velocity of the arpeggio notes are incorrect, set the [GATE] and [VELOCITY] knobs to the 12 o'clock position.

- ⑨ Try modifying the "Pitch Offset," "Gate" and "Velocity" of each step, and listen to the result. You can also try specifying two or more Tones for the same step to create polyphonic arpeggios, and also try out the "Flam" effect.

❑ Arpeggiator settings in MultiSet

For both MultiSets and programs, the arpeggiator will transmit and receive only on the Global MIDI channel (MIDI mode "Global Channel").

If you wish to play arpeggios with a MultiSet, make the following settings.

- ① In MultiSet Edit mode, set the Multi MIDI&Arp page "MIDI Ch." (see p.79) setting so that the timbre that will play the arpeggio has the same channel as the global channel.
- ② In the "Arpeggio" field, select ENA for the timbre that you wish to play the arpeggio.

7. Saving data

Data that you have edited in Program Play mode, Program Edit mode, MultiSet Play mode, MultiSet Edit mode or Arpeggio mode can be saved to internal memory, a memory card, or to an external MIDI device which can accept data dumps. Here we will explain the procedure for saving data to internal memory. If you wish to save data on an external MIDI device that can accept data dumps, refer to p.88. Parameters that you edit in MIDI mode and Global mode are saved at the time that you modify them, and do not require the Write operation.

□ About the edit buffer

When you select a Program or MultiSet or arpeggio pattern in Program Play mode or MultiSet Play mode, or when you select an arpeggio pattern, the selected data is called from internal memory into an "edit buffer." Then, when you modify parameters in Program Play, Program Edit, MultiSet Play, MultiSet Edit or Arpeggio modes, the data in the edit buffer will be modified. If you wish to save the data that was modified, you must execute the Write operation. When you execute the Write operation, the data in the edit buffer is written into the Program number, MultiSet number, or arpeggio pattern number of the corresponding bank.

If you select another Program, MultiSet or arpeggio without Writing the data, new Program, MultiSet or arpeggio pattern data will be loaded into the edit buffer. At this time, the data that you have been modifying will be saved temporarily ("[COMPARE] function," p.27), but will be lost when you begin modifying the newly selected data.

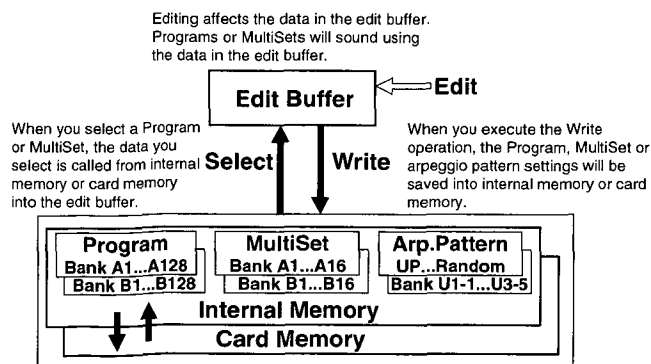

□ Memory protect

The Z1 provides a memory protect function that prevents data from being overwritten unintentionally. (i.e., this function makes it impossible to write data into memory.) Before you can Write the edited data into memory, you must turn memory protect OFF.

- ① Press the [GLOBAL] key (the LED will blink) to enter Global mode.
- ② Press the [JUMP] key, and then press knob [1] (Basic) to access the GLB Basic page.

- ③ Press knob [1] to move the cursor to the "Protect (Memory Protect)", and then rotate knob [1] to turn the setting OFF. Now you will be able to execute the Write operation.

□ Modifying a name (Rename)

An edited Program, MultiSet or arpeggio pattern can be given a new name as desired. You can also assign names to user groups to classify programs.

Renaming a Program or MultiSet

- ① Make sure that the program or MultiSet that you wish to rename is selected.
- ② Press the [CMN] key (the LED will light) to access the Common section of the program or MultiSet.
- ③ Press the [JUMP] key, then press knob [5] (Name) to move to the CMN Program Name page (for Program Edit mode) or the MLT CMN Name page (for MultiSet Edit mode).

/FX CMN/CMN

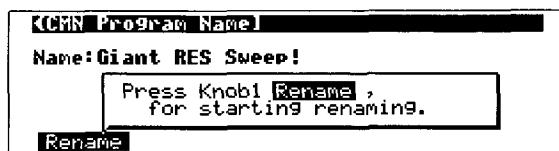

- ④ Press knob [1] (Rename) to access the Name Edit display.



- ⑤ Rotate a knob [1] to [4] to move the [↑] to the location where you wish to input the character. Pressing knob [1] will move one character toward the left, and pressing knob [2] will move one character toward the right.
- ⑥ Either by rotating knob [5] or by pressing the [-] or [+] key, select the character that you wish to input. To select a character upward or downward, you can use the [▲] or [▼] keys.
- ⑦ To delete a character, press knob [3] (Delete). To input a space, press knob [4] (Insert).

Renaming an arpeggio pattern

- ① Make sure that the arpeggio pattern that you wish to rename has been selected. However, it is not possible to assign a name to a preset pattern.
- ② Press the [ARPEGGIO] key (the LED will blink) to enter Arpeggio mode.
- ③ Press the [JUMP] key, and then press knob [3] (Name) to access the PAT Pattern Name page.
- ④ Refer to steps ④ to ⑦ to input the name.

Renaming a user group

- ① Press the [GLOBAL] key (the LED will blink) to enter Global mode.
- ② Press the [JUMP] key, and then press knob [2] (GrpNam) to access the GLB UserGroupName page.
- ③ Either by rotating knob [1] or by pressing the [+] or [-] key, select the user group number to which you wish to assign a name.
- ④ Refer to steps ④ to ⑦ to input the name.

□ Specifying the category and user group

As desired, you can classify programs into 18 categories and 16 user groups.

- ① Make sure that the program for which you wish to specify the category or user group is selected.
- ② Press the [CMN] key (the LED will light) to access the Prog Common section.

/FX CMN/CMN



- ③ Press the [JUMP] key, and then press knob [1] (Voice) to access the CMN Voice page.
- ④ Press knob [2] several times and select "Category (Program Category)." Either rotate knob [2] or press the [+] or [-] key to specify the category.
- ⑤ Press knob [2] to select "UsrGroup (User Group)." Either rotate knob [2] or press the [+] or [-] key to specify the user group.

The names of each user group can be specified in the Global section UserGroupNme page view page (see p.92).

□ The Write procedure

Writing a Program

An edited program can be written into memory in either Program Play mode or Program Edit mode. This can also be done in Global mode or MIDI mode if the currently sounding data is a program (i.e., if the [PROG] key LED is lit).

- ① Turn "Memory Protect" (the setting which prohibits writing into program memory) OFF (see p.25).
- ② If desired, assign a name to the program (see p.25), and specify the category and user group.
- ③ Press the [WRITE] key.

9 WRITE



A message will appear in the LCD

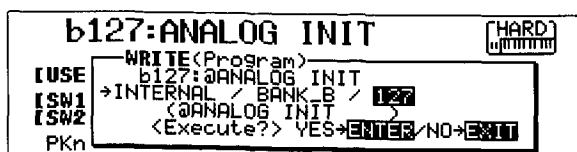

- ④ Specify the writing destination.

A program can be written into internal memories A000 to A127/B000 to B127, or if a memory card is inserted, into card memories CARD A000 to A127/CARD B000 to B127.



A memory card must first be formatted before it can be used. For details refer to p.95.

Press knob [2] to move the cursor, and either rotate knob [2] or press the [+] or [-] key to specify the destination into which the program will be written. In the same way, use knob [3] to specify the bank and knob [4] to specify the number.

Immediately after you press the [WRITE] key, the current program number will automatically be selected as the writing destination.

- ⑤ If you have not changed the writing destination from the current program number, press the [ENTER] key and the data will be written.

If you have changed the writing destination, a message will ask for confirmation, so press the [ENTER] key once again to write the data.

If you decide to cancel the Write operation, press the [EXIT] key twice.

Writing a MultiSet

An edited MultiSet can be written into memory in either MultiSet Play mode or MultiSet Edit mode. This can also be done in Global mode or MIDI mode if the currently sounding data is a MultiSet (i.e., if the [MULTI] key LED is lit).

For the procedure of saving a MultiSet, refer to the procedure for Programs described above.

A MultiSet can be written into internal memories A00 to A15/B00 to B15, or if a memory card is inserted, into card memories CARD A00 to A15/CARD B00 to B15. Also, it is not possible to specify a category or user group for a MultiSet.

Writing an arpeggio pattern

An edited arpeggio pattern can be written into memory in Arpeggio mode.

For the procedure of saving an arpeggio pattern, refer to the procedure for Programs described above.

An arpeggio pattern can be written into internal memories U1-1 to U1-5, U2-1 to U2-5, U3-1 to U3-5, or if a memory card is inserted, into card memories CARD UP to Random, CARD U1-1 to U1-5, CARD U2-1 to U2-5, CARD U3-1 to U3-5.

For both preset patterns and user patterns, the patterns which are displayed in Arpeggio mode will be saved. However when preset patterns are saved to user patterns, or when user patterns are saved to preset patterns, be aware that parameters which are not common to both types of pattern will be initialized. Also, it is not possible to specify a category or user group for an arpeggio pattern.

▲ If the memory card which you are using is a Flash EPROM type device, it will not be possible to save the edit buffer data by writing it directly into the card. You must first write the edit buffer into internal memory, and then save it by specifying "Target Card Area" in the GLB page Data Utility [Save to Card] (see p.95).

8. Convenient editing functions

□ UNDO function

The value of a parameter when it was initially selected by the cursor is remembered until the cursor is moved to a different location. After modifying a value, you can press the [UNDO] key to recall the original value. At this time, the value of the parameter at the time the [UNDO] key was pressed is also remembered, and can be recalled by pressing the [UNDO] key once again.

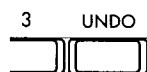

□ COMPARE function

While editing a program, MultiSet or arpeggio pattern, you can press the [COMPARE] key to return to the state (sound) before you began editing (the upper right of the display will show the COMPARE indicator). In this case, the state of settings before the [COMPARE] key was pressed is remembered, so you can press the [COMPARE] key once again to bring back the data that you had been editing and continue your modifications. This function provides a convenient way to compare the results of your editing with the original sound.

For arpeggio patterns, this function is available only in Pattern Edit mode. However for programs and MultiSets, this function is available even in the respective Play modes.

If there has been editing that was discarded (i.e., when a different program etc. is selected without saving), and you have not performed any new editing, you can recall this editing once again. Press the [COMPARE] key, and the display will ask "Recall previous edit?" Press the [ENTER] key to execute the operation. Pressing any other key will cancel the operation.



□ UTILITY functions

In various pages, a variety of functions are provided to make operation more efficient or to assist you in various ways (see p.105).

- ① Press the [UTILITY] key. The utility functions that are available will be displayed in the lower line of the LCD.



- ② Press the appropriate knob ([2] to [5]) to select the desired function, and execute it in accordance with the messages that appear.

Here we will explain some of the common utility functions.

Restoring the factory settings (Factory)

This function calls factory preset data into the edit buffer. This function is convenient when you wish to recall a factory preset Program or MultiSet and then edit it. Unlike the operation explained on p.12, the contents of internal memory will not change when this function is used to recall data, and unless you perform the Write operation, internal memory will not be affected.

Example: Restoring a factory preset program

- ① Make sure that you are in Program Play mode.
- ② Press the [UTILITY] key, and then press knob [5] (Factory). The utility menu will appear.
- ③ Rotate knob [3] to select the program that you wish to recall.
- ④ Press the [ENTER] key, and the factory preset program will be loaded into the edit buffer. If you decide not to load the factory preset program, press the [EXIT] key.



In this state, the data has not been saved to internal memory or to card memory.

Initializing settings (Init)

This operation initializes the data that has been called into the edit buffer. You can initialize all the settings of a program, a MultiSet, an arpeggio pattern or other settings, or initialize individual portions of the data.

Example: Initializing a program

- ① Make sure that you are in Program Play mode.
- ② Press the [UTILITY] key, and then press knob [4] (Init). The utility menu will appear.
- ③ Press the [ENTER] key, and the program in the edit buffer will be initialized. If you decide not to initialize, press the [EXIT] key.



In this state, the data has not been saved to internal memory or to card memory.

Example: Initializing EG3

- ① Make sure that a program has been called into the edit buffer.
- ② Press the [EG] key to access the EG section.
- ③ Press the [JUMP] key, and then press knob [3] (EG3).
- ④ Press the [UTILITY] key, and then press knob [3]. The utility menu will appear.
- ⑤ Select one of the 11 different EG types as appropriate, so that the EG settings can be initialized to the type that you select. Rotate knob [3] to select an EG type.
- ⑥ Press the [ENTER] key, and EG3 of the program which has been called into the edit buffer will be initialized to the EG type that you selected in step ⑤. If you decide not to initialize, press the [EXIT] key.

Copying and exchanging settings (Copy, Swap)

You can copy or exchange settings.

Example: Copying EG3

- ① Perform steps ① to ③ of "Initializing settings (Init)."
- ② Press the [UTILITY] key, and then press knob [4] (Copy). The utility menu will appear.
- ③ Select an EG of the copy source program. Use knob [2] to select the program source, use knob [3] to select the program bank and number, and use knob [4] to select the EG number.
- ④ Press the [ENTER] key, and the EG settings that you selected in step ③ will be copied to EG3 of the program in the edit buffer. If you decide not to copy, press the [EXIT] key.

Example: Copying effect settings

Effect Copy is convenient when you wish to use the effect settings of a program in a MultiSet, etc. The following procedure is an example of using program effect settings in a MultiSet.

- ① Make sure that a MultiSet has been called into the edit buffer.
- ② Press the [FX] key to access the Multi Fx section.
- ③ Press the [JUMP] key, and then press knob [1] (Set Up).
- ④ Press the [UTILITY] key, and then press knob [4] (Cpy Prg). The utility menu will appear. In the Fx Set Up page, Fx1, Fx2, Mst.Fx and Mst.EQ settings will all be copied. In other pages, individual effects will be copied.
- ⑤ Select the copy source effect. Rotate knob [2] to select the source, and rotate knob [3] to select the bank and number.
- ⑥ Press the [ENTER] key, and the effect settings of the MultiSet that was called into the edit buffer will be copied. To cancel the copy operation, press the [EXIT] key.

Parameter Editing Guide

Program Edit mode

MultiSet Edit mode

Arpeggio mode

MIDI mode

Global mode

Effect Type

Program Edit

MultiSet Edit

Arpeggio

MIDI

Global

Effect Type

Editing a program (Program Edit mode)

1. OSC section

The oscillator is the section which creates the "waveform," which is the most basic element that determines the tone. The Z1 is able to generate waveforms in a variety of ways.

OSC Set Up page

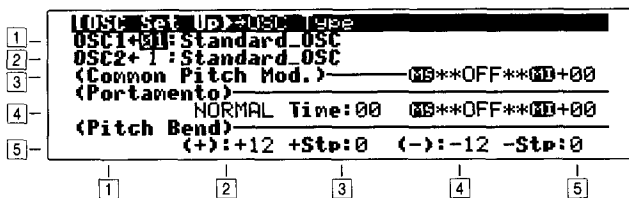

Select the Oscillator Type

1-1 OSC1 (Oscillator 1 Type) [01...13]
Select the oscillator type for oscillator 1.

- 01: Standard OSC
- 02: Comb Filter OSC
- 03: VPM OSC (Variable Phase Modulation OSC)
- 04: Resonance OSC
- 05: Ring Modulation OSC
- 06: Cross Modulation OSC
- 07: Sync Modulation OSC
- 08: Organ Model
- 09: Electric Piano Model
- 10: Brass Model
- 11: Reed Model
- 12: Plucked String Model
- 13: Bowed String Model

If a type 10 to 13 is used, it will not be possible to use OSC2 (Oscillator 2 Type).

2-1 OSC2 (Oscillator 2 Type) [1...9]
Select the oscillator type for oscillator 2 (refer to OSC1).

Modifying the oscillator pitch over time (Common Pitch Mod.)

3-4 Common Pitch Mod. Source (Mod. Source List 1)
Select the modulation source (refer to p.104) that will simultaneously modulate the pitches of oscillators 1 and 2, and the sub-oscillator.

3-5 Common Pitch Mod. Intensity [-99...+99]
Specify the depth and direction of the effect regulated by "Common Pitch Mod. Source."

Specify the way in which Portamento is applied (Portamento)

Specify the way in which Portamento will be applied. (Portamento is an effect which causes the pitch to change smoothly from the pitch of one note to the pitch of the next note.) The settings you make here will be valid when the front panel [PORTAMENTO] key is on. The [PORTAMENTO] key switches portamento on/off for each program.

4-2 Portamento Mode [NORMAL, FINGERED]
NORMAL Portamento will always apply, regardless of the playing method.
FINGERED Portamento will apply only to notes played legato (i.e., when the next note is pressed before the previous note is released).

4-3 Portamento Time [0...99]
Specify the portamento time. Higher values will cause the pitch to change more slowly.

4-4 Portamento Time Mod. Source (Mod. Source List 1)
Select a modulation source (refer to p.104) which will control "Portamento Time."

4-4 Portamento Time Mod. Intensity [-99...+99]
Specify the way in which the portamento time will be controlled by the "Portamento Time Mod. Source." With positive (+) settings, the portamento time will become longer. With negative (-) settings, the portamento time will become shorter.

Specify the width of pitch bender control (Pitch Bend)

5-2 PB Intensity (+X) [-60...+24]

Specify the amount of pitch change (in semitones) that will occur when the pitch bender is moved in the positive (+) direction. With positive (+) settings, the pitch will rise. With negative (-) settings, the pitch will fall. With a setting of 12, the pitch will change one octave.

5-3 PB Step (+X) [0,/8, /4, /2, 1 ... 12]

Specify the way in which the pitch will change when the pitch bender is moved in the positive (+) direction.

- 0 (Continuous) The pitch will change smoothly.
- /8 (1/8) The pitch will change in steps of 1/8th of a semitone.
- /4 (1/4) The pitch will change in steps of 1/4th of a semitone.
- /2 (1/2) The pitch will change in steps of 1/2 of a semitone.
- 1...12 The pitch will change in steps of the specified number of semitones (maximum of one octave).

5-4 PB Intensity (-X) [-60...+24]

Specify the amount of pitch change (in semitones) that will occur when the pitch bender is moved in the negative (-) direction.

5-5 PB Step (-X) [0,/8, /4, /2, 1 ... 12]

Specify the way in which the pitch will change when the pitch bender is moved in the negative (-) direction (refer to "Step(+)").

 If the width of change specified for "PB Step(+X)/(-X)" is greater than the pitch specified for "PB Intensity(+X)/(-X)," the pitch will not change.

.....
OSC1 page

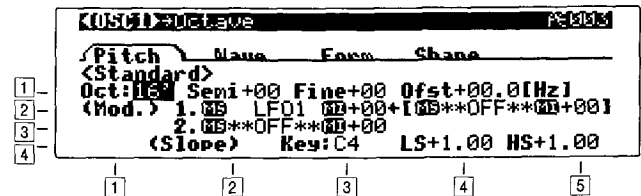

Pitch tab

Specify the basic pitch of oscillator 1 (Pitch)

1-1 Octave [32'...4']

Specify the basic pitch of oscillator 1 in steps of an octave. 32' is two octaves below, 16' is one octave below, 8' is standard pitch, and 4' is one octave above.

1-2 Semi Tone [-12...+12]

Adjust the basic pitch specified by "Octave" in semitone steps.

1-3 Fine Tune [-50...+50 cents]

Make fine adjustments to the pitch in one-cent steps.

1-4 Frequency Offset [-10.0...+10.0 Hz]

Make fine adjustments to the pitch in 0.1 Hz steps.

Modulate the pitch (Pitch Modulation)

2-1 Pitch Mod.1 Source (Mod.Source List 1)

Select a modulation source (see p.104) which will modify the pitch (e.g., apply vibrato).

2-2 Pitch Mod.1 Intensity [-99...+99]

Specify the depth and direction of the pitch change that will be controlled by "Pitch Mod.1 Source."

2-3 Pitch Mod.1 Int.Controller (Mod.Source List 1)

Specify the controller (see p.104) which will control the "Pitch Mod.1 Intensity."

2-4 Pitch Mod.1 Int.Control Intensity [-99...+99]

Specify the depth of the pitch modulation effect controlled by "Pitch Mod.1 Int.Controller."

3-1 Pitch Mod.2 Source (Mod.Source List 1)

3-2 Pitch Mod.2 Intensity [-99...+99]

Refer to the above "Pitch Mod.1 Source" and "Pitch Mod.1 Intensity."

Specify how pitch will change in relation to the keyboard (key)

4-3 Center Key[C-1...G9]
Specify the key at which Lower/Higher keyboard tracking will begin to apply.

4-4 Lower Slope [-1.00...+2.00]
Specify the depth and direction of the pitch change that will occur for notes below the "Center Key."

4-5 Higher Slope [-1.00...+2.00]
Specify the depth and direction of the pitch change that will occur for notes above the "Center Key."

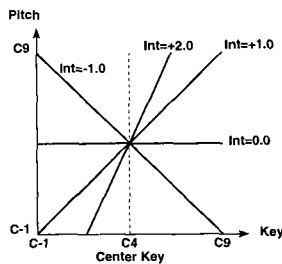

If "Lower Slope" and "Higher Slope" are set to values of +2.0, playing a note one octave above the "Center Key" will sound a pitch that is two octaves higher. With a setting of -1.0, playing a note one octave above will sound a pitch that is one octave lower. With a setting of 0.0, pitches in the specified area will be fixed. If you want pitches to correspond with the keyboard in the normal fashion, set these parameters to +1.0.

.....
OSC2 page

Here you can make settings for the oscillator type, basic pitch, pitch keyboard tracking, and pitch modulation of oscillator 2. The parameters of oscillator 2 are the same as for oscillator 1. (Refer to the explanation of the OSC1 page).

.....
Settings specific to each oscillator type

Here you can make settings which are specific to each oscillator type. The oscillator type is selected in OSC1/2 of the OSC Set Up page.

Standard OSC

This oscillator produces the waveforms used by an analog synthesizer (sawtooth wave, pulse wave, triangle wave) and sine wave. Sawtooth wave, pulse wave and triangle wave waveforms can be modified using waveform modulation. You can specify either sawtooth wave or pulse wave as the main waveform, and mix triangle wave or sine wave with this for output. The level of these three waveforms can be adjusted independently. In addition, wave shaping can be applied to the output of this oscillator.

Waveform modulation

Pulse width modulation (PWM) is a function found on analog synthesizers that modulates the width of a pulse waveform over time. On the Z1, "waveform modulation" allows you to create this type of modulation not only on a pulse wave, but also on sawtooth waves or triangle waves.

Sawtooth wave

Waveform modulation will modify a sawtooth waveform as shown below, creating time-variant change in the sound. When modulation is 0, the basic sawtooth waveform will be produced, and when it is 99, a sawtooth wave of double the frequency will be produced. If the modulation value is a negative number, a different effect will result than with positive settings.

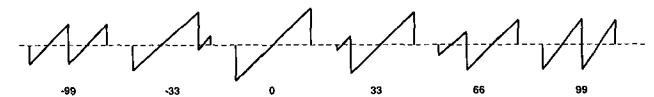

Pulse wave

Waveform (pulse width) modulation will modify a pulse waveform as shown below, creating time-variant change in the sound. When modulation is 0, a square wave will be produced, and when it is 99, the pulse width will be 0, meaning that there will be no sound. If the modulation value is a negative number, the results will be inverted.

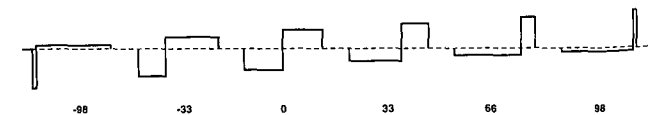

Ramp wave

Waveform modulation will modify a ramp wave as shown below, creating time-variant change in the sound. When modulation is 0, a triangle wave will result, and as the modulation value increases, the waveform will become a ramp wave (a waveform in which the slope is broken in two). At a modulation value of 50, a trapezoidal wave will

result, and at a value of 99 the waveform will once again be a triangle wave. If the modulation value is a negative number, the results will be inverted.

Compared to sawtooth or pulse waves, this waveform produces a strong fundamental with fewer overtones, making it particularly suitable for bass sounds etc.

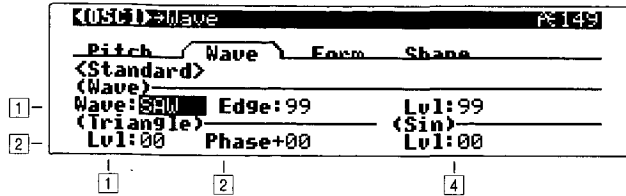
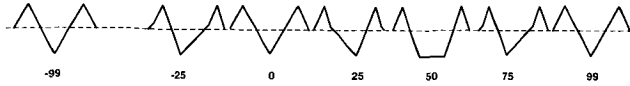

Wave tab

1-1 Wave Select [SAW, PULSE]

Select the main waveform. Select either SAW (sawtooth wave) or PULSE (pulse wave).

1-2 Wave Edge [0...99]

Adjust the amount of high-range overtones for the main waveform. As the pitch rises, this effect will become stronger, and in the low range there will be little effect. Lower settings of this parameter will produce a more mellow sound, and in the vicinity of 0 the volume will also decrease.

1-4 Wave Level [0...99]

Specify the output level of the main waveform.

2-1 Triangle Level [0...99]

Specify the output level of the triangle waveform. It will be output mixed with the main waveform.

2-2 Triangle Phase Shift [-99...+99]

Specify the phase difference between the main waveform and the triangle and sine waveforms. (The triangle and sine waveforms will always be in phase with each other.)

2-4 Sine Level [0...99]

Specify the output level of the sine waveform. It will be output mixed with the main waveform.

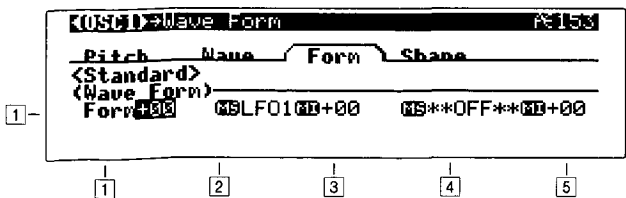

Wave Form tab

1-1 Wave Form [-99...+99]

Specify the waveform. For the way in which this value will affect the waveform, refer to the diagrams shown on the previous page for sawtooth wave, pulse wave, and ramp wave.

1-2 Wave Form Mod.LFO [LFO1...LFO4]

Select the source LFO for waveform modulation. LFO settings are made in the LFO section.

1-3 Wave Form Mod.LFO Intensity [-99...+99]

Specify the depth and direction of the waveform modulation that will be controlled by the LFO specified in "Wave Form Mod.LFO."

1-4 Wave Form Mod.Source (Mod.Source List 1)

Select the waveform modulation source.

1-5 Wave Form Mod.Intensity [-99...+99]

Specify the depth and direction of the waveform modulation controlled by the "Wave Form Mod.Source." For negative settings, the polarity of the modulation source will be inverted.

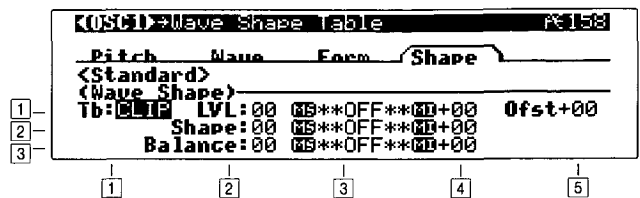

Wave Shape tab

1-1 Wave Shape Table [CLIP, RESO]

Select the wave shaping table that will modify the input waveform. Depending on the selection of CLIP (clip type) or RESO (resonant type), the waveform will change as shown in the diagram (2-2 Wave Shape).

1-2 Wave Shape Input Level [0...99]

Specify the level of the signal that is input from the standard oscillator to the wave shaping table.

Example of when Input Level is modified (Table Type : Reso)

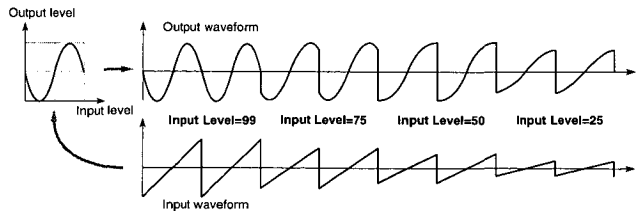

1-3 Wave Shape Input Level Mod.Source (Mod.Source List 1)

Select the modulation source which will control "Wave Shape Input Level." (see p.104)

1-4 Wave Shape Input Level Mod.Intensity [-99...+99]X

Specify the depth and direction of the effect of "Wave Shape Input Level Mod.Source."

1-5 Wave Shape Offset [-99...+99]

Specify an offset amount that will be added to the signal specified by "Wave Shape Input Level."

Example of when Offset is modified (Table Type: Clip)

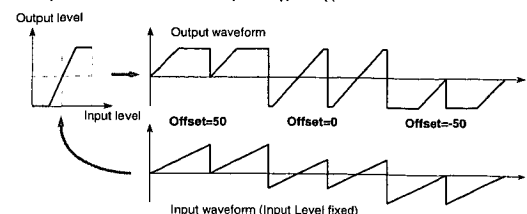

2-2 Wave Shape [0...99]

Specify the characteristics of the table which will modify the input waveform. The characteristics of the table will change as follows.

Shape of the wave shaping table and the Shape parameter

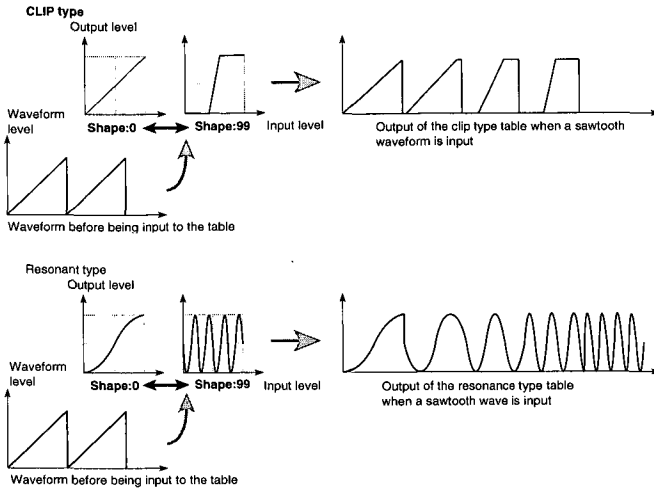

2-3 Wave Shape Mod.Source (Mod.Source List 1)

Select a modulation source (see p.104) that will control "Wave Shape."

2-4 Wave Shape Mod.Intensity [-99...+99]

Specify the depth and direction of the effect of "Wave Shape Mod.Source."

3-2 Wave Shape Balance [0...99]

Specify the balance between the signal that has passed through the wave shaping table and the output signal from the standard oscillator. With a setting of 99, it will be only the output of the wave shaping table.

3-3 Wave Shape Balance Mod.Source (Mod.Source List 1)

Select a modulation source (see p.104) that will control "Wave Shape Balance."

3-4 Wave Shape Balance Mod.Intensity [-99...+99]

Specify the depth and direction of the effect of "Wave Shape Balance Mod.Source."

COMB Filter OSC

In this oscillator, the signal from the other oscillator waveform or the noise generator is sent through a comb filter, and the feedback level of the comb filter is varied in order to produce tonal change. When noise is input, raising the feedback of the comb filter will gradually change the sound into a pitched tone.

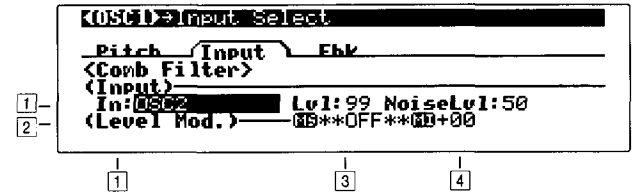
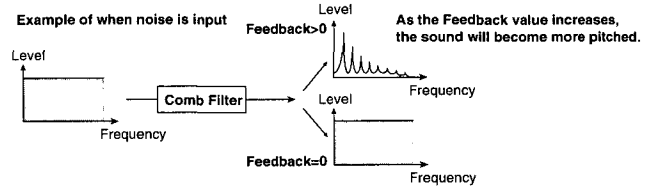
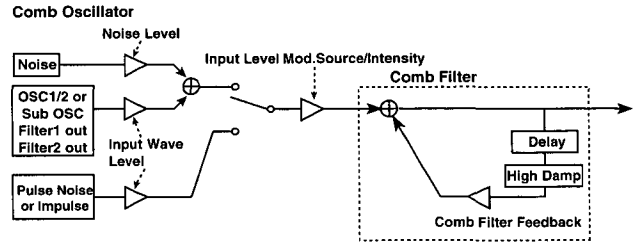

Input tab

1-1 Input Select [OSC2(1)+NOISE, SubOSC+NOISE, Filter1+NOISE, Filter2+NOISE, PULSE_NOISE, IMPULSE]

Select the signal that will be input to the comb filter.

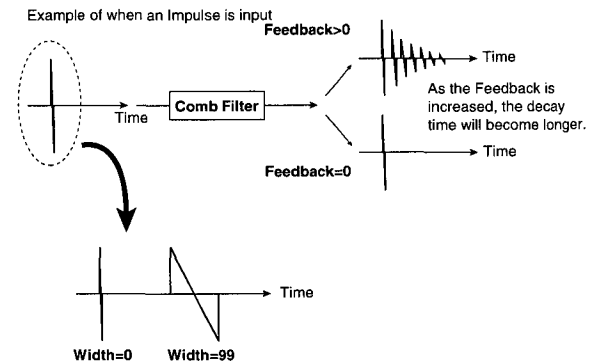

1-3 Input Wave Level [0...99]

If "Input Select" has been set to OSC2(1)+NOISE, SubOSC+NOISE, Filter1+NOISE or Filter2+ NOISE, you can specify the volume level of the other oscillator or the sub-oscillator which will be input to the comb filter.

If "Input Select" has been set to PULSE_NOISE or IMPULSE, you can specify the volume level of the

PULSE_NOISE or IMPULSE that will be input to the comb filter.

1-4 Noise Level [0...99]

This parameter will be available only if "Input Select" has been set to OSC2(1)+NOISE, SubOSC+NOISE, Filter1+NOISE or Filter2+NOISE. It specifies the volume level of the noise generator output which will be input to the comb filter.

1-4 Width [0...99]

This parameter will be available only if "Input Select" has been set to PULSE_NOISE or IMPULSE. It specifies the length of time that the PULSE_NOISE or IMPULSE will last after being triggered.

2-3 Input Level Mod.Source (Mod.Source List 1)

Select a modulation source (see p.104) that will control the volume level of the signal being input to the comb filter. The volume level is set by the "Input Wave Level" or the "Noise Level."

2-4 Input Level Mod.Intensity [-99...+99]

Specify the depth and direction of the effect of "Input Level Mod.Source."

3-2 High Damp [0...99]

Specify the amount of attenuation that will be applied to the high-frequency component of the feedback signal within the comb filter.

As this value is increased, the tone will become more mellow. Conversely, decreasing this value will produce a brighter tone.

3-3 High Damp Mod.Source (Mod.Source List 1)

Select a modulation source (see p.104) that will control "High Damp."

3-4 High Damp Mod.Intensity [-99...+99]

Specify the depth and direction of the effect of "High Damp Mod.Source."VPM OSC

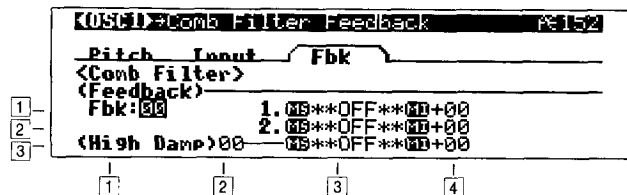

Feedback tab

1-1 Comb Filter Feedback [0...99]

Specify the amount of feedback for the comb filter. If this value is high, the resonance of the comb filter will be high, and the tone will have a clear sense of pitch. Conversely, if this value is low, the input signal will be output without change, and if the input signal is only noise, the output signal will have no sense of pitch.

1-3 Feedback Mod.1 Source (Mod.Source List 1)

Select a modulation source (see p.104) that will control "Comb Filter Feedback."

1-4 Feedback Mod.1 Intensity [-99...+99]

Specify the depth and direction of the effect of "Feedback Mod.1 Source."

2-3 Feedback Mod.2 Source (Mod.Source List 1)

2-4 Feedback Mod.2 Intensity [-99...+99]

Refer to the above "Feedback Mod.1 Source" and "Feedback Mod.1 Intensity."

VPM OSC

The output of a carrier is phase-modulated by a modulator, and output through wave shape processing. By controlling the wave shaping parameters and the feedback gain, tonal changes that are different than simple phase modulation can be produced.

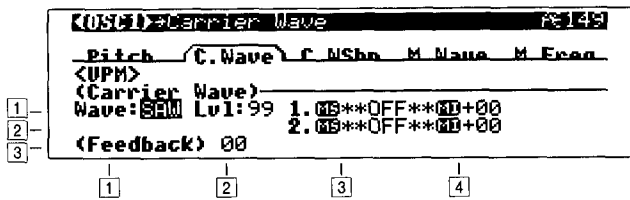
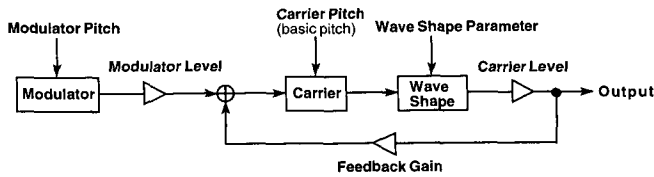

Carrier Wave tab

- 1-1 **Carrier Wave** [SAW, SQU, TRI, SIN]
Select the carrier waveform.
- 1-2 **Carrier Level** [0...99]
Specify the output level of the carrier. This will determine the output level of the VPM oscillator.
- 1-3 **Carrier Level Mod.1 Source** (Mod.Source List 1)
Select a modulation source (see p.104) that will control the carrier level.
- 1-4 **Carrier Level Mod.1 Intensity** [-99...+99]
Specify the depth and direction of the effect of "Carrier Level Mod.1 Source."
- 2-3 **Carrier Level Mod.2 Source** (Mod.Source List 1)
- 2-4 **Carrier Level Mod.2 Intensity** [-99...+99]
Refer to the above "Carrier Level Mod.1 Source" and "Carrier Level Mod.1 Intensity."
- 3-2 **Feedback** [0...99]
Specify the amount of the output after wave shaping that will be fed back to the carrier.

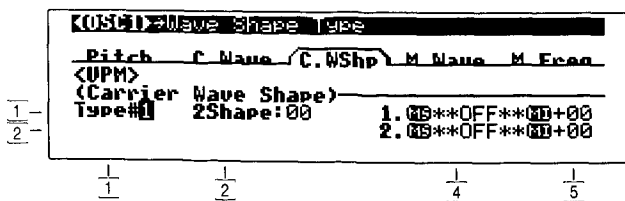

Carrier Wave Shape tab

- 1-1 **Type** [1, 2]
With a setting of 1, the signal after wave shaping will be output without further change. If "Wave Shape" is set to the minimum value, the phase modulated signal will be output essentially without change. With a setting of 2, a rounded waveform will be obtained regardless of the "Wave Shape" value.
- 1-2 **Wave Shape** [0...99]
Specify the number of cycle of wave shaping. As this value is increased, the number of cycles will increase, causing more overtones to be added to the high-frequency range of the sound.

Table variation

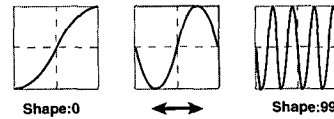

- 1-4 **Wave Shape Mod.1 Source** (Mod.Source List 1)
Select a modulation source (see p.104) that will control the "Wave Shape" value.
- 1-5 **Wave Shape Mod.1 Intensity** [-99...+99]
Specify the depth and direction of the effect of "Wave Shape Mod.1 Source."
- 2-4 **Wave Shape Mod.2 Source** (Mod.Source List 1)
- 2-5 **Wave Shape Mod.2 Intensity** [-99...+99]
Refer to the above "Wave Shape Mod.1 Source" and "Wave Shape Mod.1 Intensity."

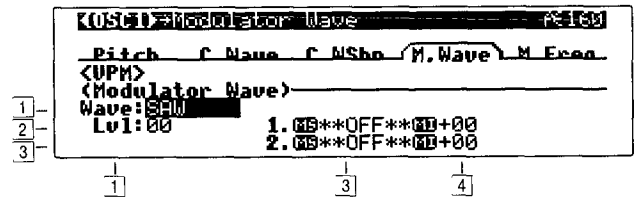

Modulator Wave tab

- 1-1 **Modulator Wave** [SAW, SQU, TRI, SIN, OSC2(1), Sub OSC, Filter 1, Filter 2]
Select the modulator waveform. Select the other oscillator OSC2(1) or the sub-oscillator etc.
- 2-1 **Modulator Level** [0...99]
Specify the output level of the modulator. This setting will determine the amount of modulation that is applied to the carrier.
- 2-3 **Level Mod.1 Source** (Mod.Source List 1)
Select a modulation source (see p.104) that will control the "Modulator Level."
- 2-4 **Level Mod.1 Intensity** [-99...+99]
Specify the depth and direction of the effect of "Level Mod.1 Source." Mod.1 Source."

3-3 Level Mod.2 Source (Mod.Source List 1)

3-4 Level Mod.2 Intensity [-99...+99]
Refer to the above "Level Mod.1 Source" and "Level Mod.1 Intensity."

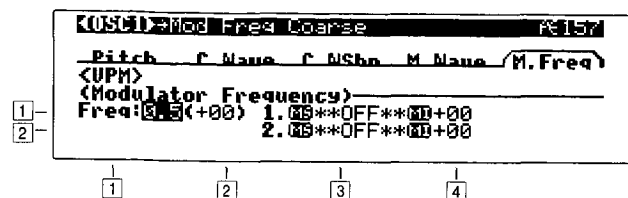

Modulator Frequency tab

1-1 Mod. Frequency Coarse [0.5, 1...16]
Specify the ratio of the modulation pitch to the carrier.

1-2 Mod.Frequency Fine [-50...+50]
Make fine adjustments to the pitch of the modulator.

1-3 Frequency Mod.1 Source (Mod.Source List 1)
Select a modulation source (see p.104) that will control the pitch of the modulator.

1-4 Frequency Mod.1 Intensity [-99...+99]
Specify the depth and direction of the effect of "Frequency Mod.1 Source."

2-3 Frequency Mod.2 Source (Mod.Source List 1)

2-4 Frequency Mod.2 Intensity [-99...+99]
Refer to the above "Frequency Mod.1 Source" and "Frequency Mod.1 Intensity."

Resonance OSC

This oscillator produces a wide range of tonal change by allowing you to specify the cutoff frequency and resonance of four band pass filters (BPF). You can select one of the following sources to be the input for the filters: the output of the other oscillator, the sub-oscillator, the output of the noise generator, or the output of filter 1 or filter 2.

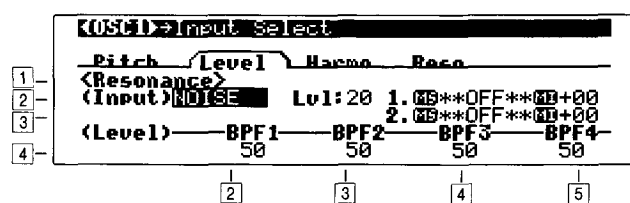
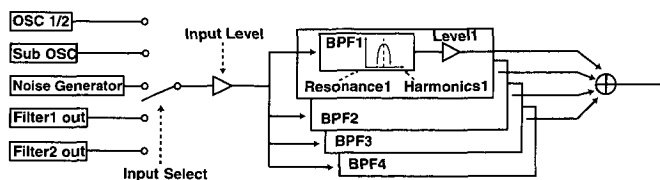

Level tab

1-2 Input Select [OSC2(1), Sub OSC, Noise, Filter 1, Filter 2]

Select the signal that will be input to the four band pass filters.

 If you assign the Resonance OSC to oscillators 1 and 2 and select the output of each oscillator as the input for the other oscillator, there will be no sound.

1-3 Input Level [0...99]
Specify the level of the signal that is input to the four band pass filters.

1-4 Input Level Mod.1 Source (Mod.Source List 1)
Select a modulation source (see p.104) that will control "Input Level."

1-5 Input Level Mod.1 Intensity [-99...+99]
Specify the depth and direction of the effect of "Input Level Mod.1 Source."

2-4 Input Level Mod.2 Source (Mod.Source List 1)

2-5 Input Level Mod.2 Intensity [-99...+99]
Refer to "Input Level Mod.1 Source" and "Input Level Mod.1 Intensity" above.

3-2 BPF1 level [0...99]

3-3 BPF2 level [0...99]

3-4 BPF3 level [0...99]

3-5 BPF4 level [0...99]
Specify the output levels of band pass filters 1 to 4.

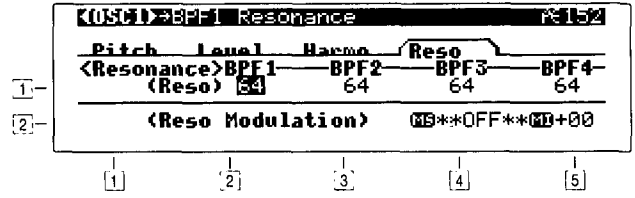
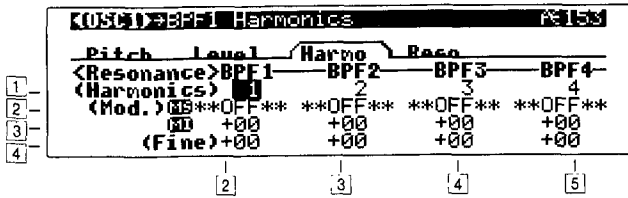

Harmonics tab

BPF1

- 1-2 BPF1 Harmonics [1...16]
Specify the center frequency of band pass filter 1 in steps of overtones (harmonics) relative to the pitch of the oscillator. The range is from the first harmonic to the 16th harmonic.
- 2-2 BPF1 Harmonics Mod.Source (Mod.Source List 1)
Select a modulation source (see p.104) that will control "BPF1 Harmonics."
- 3-2 BPF1 Harmonics Mod.Intensity [-15...+15]
Specify the depth and direction of the effect of "BPF1 Harmonics Mod.Source." With positive (+) settings, the "BPF1 Harmonics" value will be increased. With negative (-) settings, its value will be decreased. Since in this case the center frequency of the band pass filter will change in units of overtones, the pitch will change in stepwise fashion.
- 4-2 BPF1 Frequency Fine [-1.0 ...+1.0]
Make fine adjustments to the center frequency of band pass filter 1 that was specified by "BPF1 Harmonics."

BPF2, BPF3, BPF4

- 1-2 BPF2 Harmonics [1...16]
- 2-2 BPF2 Harmonics Mod.Source (Mod.Source List 1)
- 3-2 BPF2 Harmonics Mod.Intensity [-15...+15]
- 4-2 BPF2 Frequency Fine [-1.0 ...+1.0]
- 1-2 BPF3 Harmonics [1...16]
- 2-2 BPF3 Harmonics Mod.Source (Mod.Source List 1)
- 3-2 BPF3 Harmonics Mod.Intensity [-15...+15]
- 4-2 BPF3 Frequency Fine [-1.0 ...+1.0]
- 1-2 BPF4 Harmonics [1...16]
- 2-2 BPF4 Harmonics Mod.Source (Mod.Source List 1)
- 3-2 BPF4 Harmonics Mod.Intensity [-15...+15]
- 4-2 BPF4 Frequency Fine [-1.0 ...+1.0]
Refer to "BPF1" above.

Resonance tab

- 1-2 BPF1 Resonance [0...99]
- 1-3 BPF2 Resonance [0...99]
- 1-4 BPF3 Resonance [0...99]
- 1-5 BPF4 Resonance [0...99]
Specify the resonance of band pass filters 1 to 4. Higher values will produce a stronger effect.
- 2-4 Resonance Mod.Source (Mod.Source List 1)
Select a modulation source (see p.104) that will control the resonance that was specified for each band pass filter.
- 2-5 Resonance Mod.Intensity [-99...+99]
Specify the depth and direction of the effect of "Resonance Mod.Source."

Ring Modulation OSC

This multiplies the modulator and carrier and outputs the signal produced. One of four types of waveform can be selected as the carrier. Since the result will be a metallic sound with little sense of pitch, this is suitable for producing sound effects. The Ring Modulation oscillator contains an internal carrier oscillator. The output of the other oscillator etc. can be selected as the modulator.

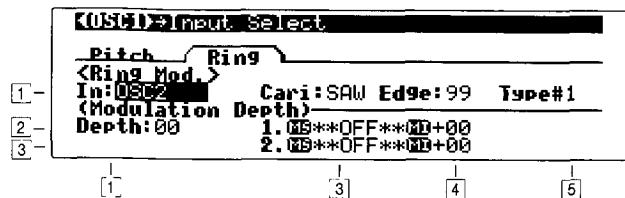
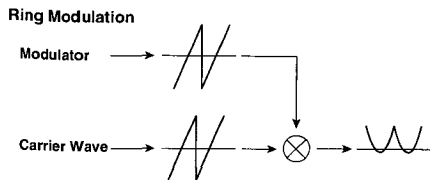

1-1 Input Select [OSC2(1), SubOSC, Noise, Filter 1, Filter 2]
Specify the modulator.

1-3 Carrier Wave [SAW, SQU, TRI, SIN]
Specify the carrier waveform.

1-4 Modulator Wave Edge [0...99]
Specify the amount of high frequency harmonics for the carrier waveform. As this value is decreased, the sound will have less high-frequency harmonics, and as it approaches 0 the volume will also decrease.

1-5 Type [1, 2]
Select the modulation type. The two types differ in the tone of the high range. Type 2 will produce a brighter sound than type 1.

2-1 Modulation Depth [0...99]
Specify the depth of modulation. At a setting of 0, the carrier waveform will be output without change.

2-3 Modulation Depth Mod.1 Source (Mod.Source List 1)
Select a modulation source (see p.104) that will control "Modulation Depth."

2-4 Modulation Depth Mod.1 Intensity [-99...+99]
Specify the depth and direction of the effect of "Modulation Depth Mod.1 Source."

3-3 Modulation Depth Mod.2 Source (Mod.Source List 1)

3-4 Modulation Depth Mod.2 Intensity [-99...+99]
Refer to "Modulation Depth Mod.1 Source" and "Modulation Depth Mod.1 Intensity" above.

Cross Modulation OSC

This uses a modulator to frequency-modulate a carrier. You can select one of four waveforms as the carrier. In general, a pitch envelope is applied to the modulator. A carrier oscillator is built-in to the Cross Modulation OSC. You can select the output of the other oscillator etc. as the modulator.

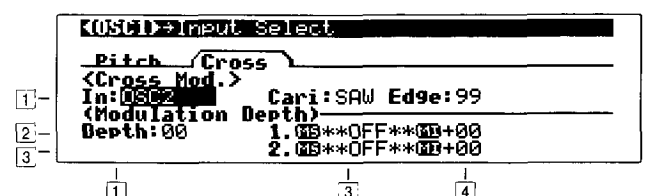
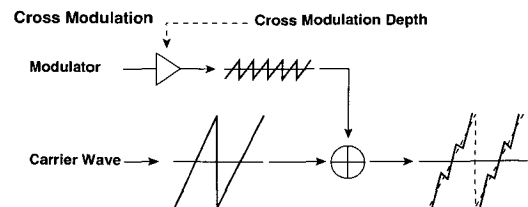

1-1 Input Select [OSC2(1), SubOSC, Noise, Filter 1, Filter 2]
Specify the modulator.

1-3 Carrier Wave [SAW, SQU, TRI, SIN]
Specify the carrier waveform.

1-4 Modulator Wave Edge [0...99]
Specify the amount of high frequency harmonics for the carrier waveform. As this value is decreased, the sound will have less high-frequency harmonics, and as it approaches 0 the volume will also decrease.

2-1 Modulation Depth [0...99]
Specify the depth of modulation. At a setting of 0, the carrier waveform will be output without change.

2-3 Modulation Depth Mod.1 Source (Mod.Source List 1)
Select a modulation source (see p.104) that will control "Modulation Depth."

2-4 Modulation Depth Mod.1 Intensity [-99...+99]
Specify the depth and direction of the effect of "Modulation Depth Mod.1 Source."

3-3 Modulation Depth Mod.2 Source (Mod.Source List 1)

3-4 Modulation Depth Mod.2 Intensity [-99...+99]
Refer to "Modulation Depth Mod.1 Source" and "Modulation Depth Mod.1 Intensity" above.

Sync Modulation OSC

This uses the modulator as the master waveform and the carrier as the slave waveform (which will be synchronized to the master).

When the master waveform begins a new cycle (i.e., the instant that it passes the zero point going from negative to positive), the phase of the slave waveform is reset to 0, causing it to begin a new cycle.

Sync Modulation

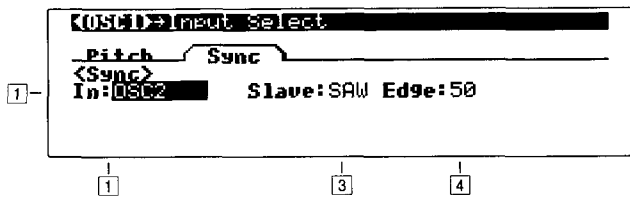
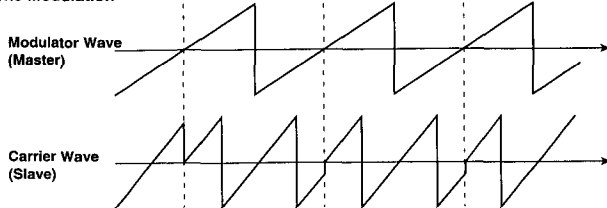

1-1 Input Select [OSC2(1), SubOSC, Noise, Filter 1, Filter 2]
Specify the master waveform (modulator).

1-3 Slave Wave [SAW, SQU, TRI, SIN]
Specify the slave waveform.

1-4 Modulator Wave Edge [0...99]
Specify the amount of high frequency harmonics for the slave waveform. As this value is decreased, the sound will have less high-frequency harmonics, and as it approaches 0 the volume will also decrease.

Organ Model

This is an oscillator used to produce organ-type sounds. The oscillator simulates three drawbars similar to electric organs of the past.

You can specify the footage [Harmo] and waveform setting for each drawbar, allowing a wide range of sounds to be created.

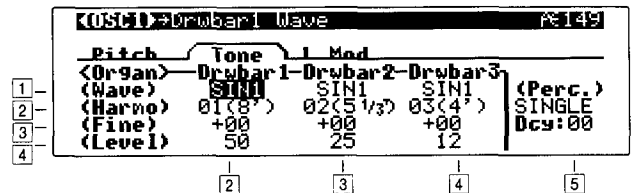
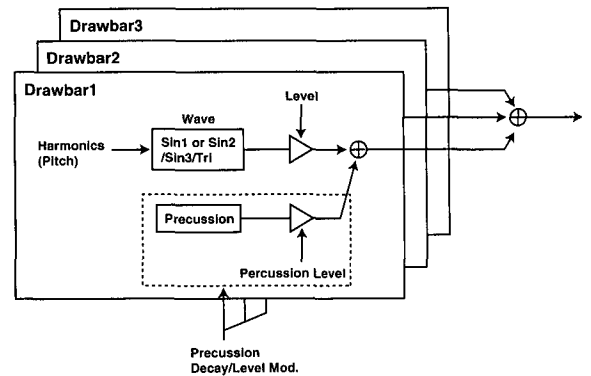

Drawbar 1

Tone tab

1-2 Drawbar 1 Wave [SIN1, SIN2, SIN3, TRI]

Specify the waveform for drawbar 1. SIN1 contains only the fundamental (i.e., a pure sine wave). SIN2 and SIN3 are waveforms which contain the first two and the first three harmonics respectively.

2-2 Drawbar 1 Harmonics [1...16]

Specify the pitch of drawbar 1, relative to one octave below the oscillator pitch.

3-2 Drawbar 1 Fine Tune [-50...+50]

Make fine adjustments to the pitch of drawbar 1.

4-2 Drawbar 1 Level [0...99]

Specify the volume level of drawbar 1.

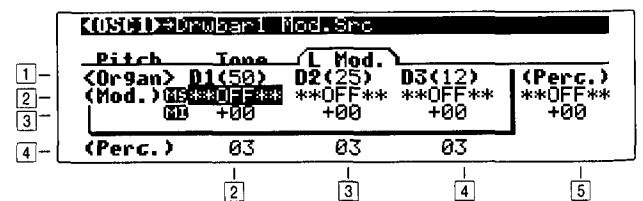

Level Mod. tab

- 1-2 Drawbar 1 Level** [0...99]
This is the same parameter as "Drawbar 1 Level" in the Tone tab.
- 2-2 Level Mod.Source** (Mod.Source List 1)
Select a modulation source (see p.104) that will control the "Level" of drawbar 1.
- 3-2 Level Mod.Intensity** [-99...+99]
Specify the depth and direction of the effect of "Level Mod.Source."

Drawbar2, Drawbar3

Refer to "Drawbar 1" above.

Percussion

Tone tab

- 2-5 Percussion Trigger Mode** [SINGLE, MULTI]
Specify how the percussion effect will be triggered. With a setting of **MULTI**, the percussion effect will apply to each note that is played. With a setting of **SINGLE**, the percussion effect will be applied to the first note that is played from a state of silence.
- 3-5 Percussion Decay** [0...99]
Specify the decay length of the percussion. As this value is increased the decay time will become longer.

Level Mod. tab

- 4-2 Drawbar 1 Percussion Level** [0...99]
- 4-3 Drawbar 2 Percussion Level** [0...99]
- 4-4 Drawbar 3 Percussion Level** [0...99]
Specify the volume level of the percussion effect for each drawbar.
- 2-5 Percussion Level Mod.Source** (Mod.Source List 1)
Select a modulation source (see p.104) that will control the percussion level of each drawbar.
- 3-5 Percussion Level Mod.Intensity** [-99...+99]
Specify the depth and direction of the effect of "Percussion Level Mod.Source" on the percussion level.

Electric Piano Model

This oscillator simulates the sound of an electric piano. There are four groups of parameters: **Hammer** (which specifies how the shape and motion of the hammer will affect tonal change and attack noise), **Tone Generator** (which vibrates in response to being struck by the hammer), **Pickup** (which specifies the tonal change that occurs when the vibration of the tone generator is converted into an electrical signal), and **Low EQ** (which is a shelving-type low EQ to adjust the low range).

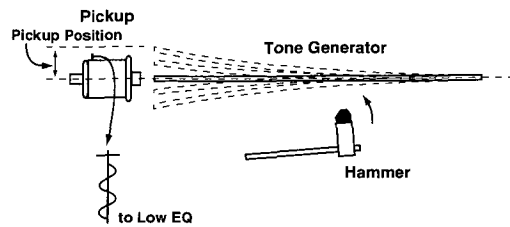

	1	2	3	4	5
[OSC] Hammer Force					
Pitch					
Tone					
Pickup					
<E. Piano>					
(Hammer)					
Force: 50					
UC: --					
Width: 50					
Clic: 00					
(ToneGenerator) (Overtone)					
Dcy: 99					
Rls: 99					
Lvl: 00					
Freq: 00					
Dcy: 00					

Tone tab

Hammer

- 1-1 Hammer Force** [0...99]
Specify the "strength" with which the hammer strikes the tone generator. Higher settings will produce a brighter sound.
- 1-2 Hammer Force Velocity Curve** [- -, 0...99]
Specify how changes in velocity will affect "Hammer Force." As this value is increased, velocity will have a greater effect on "Hammer Force," allowing more dynamic tonal change to be produced. With a setting of --, the "Hammer Force" will be constant.
- 1-3 Hammer Width** [0...99]
This simulates the shape of the hammer. As this value is increased, the width of the hammer will become narrower, and the sound of the tone generator and hammer noise will become sharper.
- 1-4 Hammer Click Level** [0...99]
This specifies the volume of the hammer noise that occurs at the attack.

Tone Generator

- 2-1 TG Decay** [0...99]
Specify the decay time of the tone generator.
- 2-2 TG Release** [0...99]
Specify the release time of the tone generator.

 The "TG Decay" and "TG Release" that you specify here will control the output level of the oscillator. In order to hear the results of these settings, be sure to set the EG decay and release of the "Amplitude Modulation Source" to longer settings.

- 2-3 Overtone Level** [0...99]
Specify the volume of the higher overtones that are produced when the tone generator vibrates.
- 2-4 Overtone Frequency** [0...99]
Specify the frequency of the overtones.
- 2-5 Overtone Decay** [0...99]
Specify the decay time of the overtone volume.

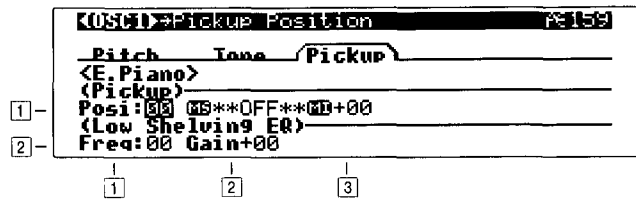

Pickup tab

Pickup

- 1-1 Pickup Position** [0...99]
Specify the location of the pickup in relation to the tone generator. With low settings, the pickup will be placed in the center of the vertical vibration of the tone generator, causing the second partial to be emphasized and the fundamental to be less audible.
- 1-2 Pickup Position Mod.Source** (Mod.Source List 1)
Select a modulation source (see p.104) that will control "Pickup Position."
- 1-3 Pickup Position Mod.Int** [-99...+99]
Specify the depth and direction of the effect of "Pickup Position Mod.Source."

Low EQ

Make settings for a Low EQ (shelving type) that will adjust the output signal.

- 2-1 Low EQ Frequency** [0...49]
Specify the cutoff frequency of the Low EQ (shelving type) that will be applied to the output signal.
- 2-2 Low EQ Gain** [-18...+18 dB]
Specify the gain of the Low EQ.

Brass Model

This oscillator is a physical model simulation of lip-reed instruments such as a trumpet. By using key velocity or the modulation wheel etc. to modulate the **Pressure** (the force of breath that is blown into the mouthpiece), you can produce performance expressions that are very similar to those of an actual lip-reed instrument.

There are four groups of parameters: **Inst** (which selects a model to specify the length and shape of the instrument bore), **Pressure** (which specifies the force of the breath that is blown into the mouthpiece), **Lip** (which produces the tonal change caused by the shape and tension of the mouth), and **Bell** (which controls the tonal change caused by the shape of the end of the bore, and a final adjustment regulated by the Peaking EQ).

Signal Flow



Brass Model

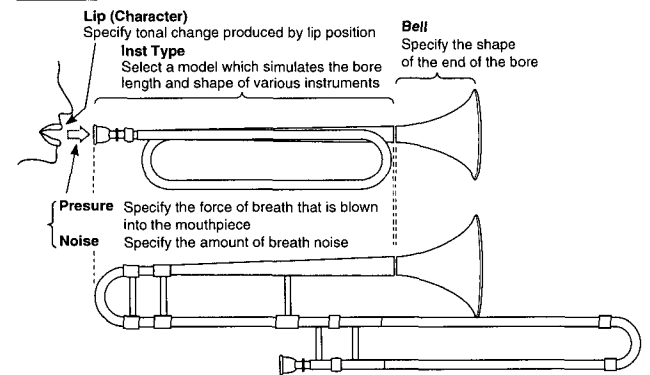

This oscillator allows you to choose from two types of pitch bending: jump bending using a mode jump as on a trumpet (by varying the bore length), and smooth bending produced by sliding the length of the bore as on a trombone.

 For some parameter settings, the pitch may not change according to the notes that are played on the keyboard.

In some cases, high-pitched notes may have a lower volume, or may not sound at all.

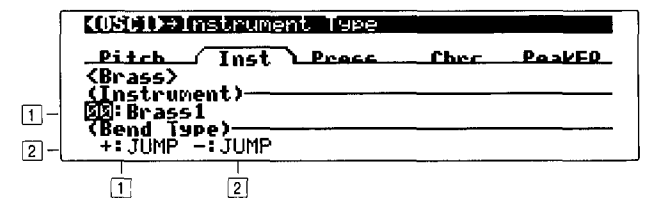

Instrument Type tab

- 1-1 Instrument Type** [Brass...ReedBrass]
Select the instrument type whose bore length and shape will be simulated.

Brass 1, Brass 2, Brass 3, Horn 1, Horn 2, ReedBrass

2-1 Pitch Bend + [Smooth, Jump]

Specify how the pitch will change when pitch bending is applied in the + direction.

Smooth: The pitch will rise smoothly as on most synthesizers.

Jump: The pitch will rise abruptly, as when the bore length is changed on a trumpet.

2-2 Pitch Bend - [Smooth, Jump]

Specify how the pitch will change when pitch bending is applied in the - direction.

Depending on the mode of resonance, there may be cases in which "Pitch Bend +" and "Pitch Bend -" do not sound.

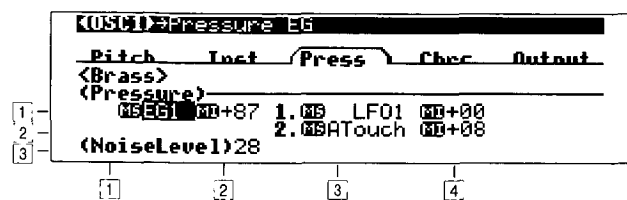

Pressure tab

1-1 Pressure EG [EG1...EG4, A.EG]

Select the EG that will control pressure. For the settings of each EG, refer to p.57 for EG1 to 4 or to p.55 for the A.EG.

1-2 Pressure EG Intensity [-99...+99]

Specify the depth and direction of the effect that the "Pressure EG" will have on the pressure.

1-3 Pressure Mod.1 Source (Mod.Source List 1)

Select a modulation source (see p.104) that will control pressure. If you select "After Touch," pressing down on the keyboard will produce the effect of the instrument being blown strongly. If you select "Modulation Wheel," rotating the [MOD WHEEL] in the + direction will produce this effect. In this case, setting "Pressure EG Intensity" to 0 will allow you to completely control the breath pressure by operating the specified controller.

1-4 Pressure Mod.1 Intensity [-99...+99]

Specify the depth and direction of the change in pressure controlled by "Pressure Mod.1 Source."

2-3 Pressure Mod.2 Source (Mod.Source List 1)

2-4 Pressure Mod.2 Intensity [-99...+99]

Refer to "Pressure Mod.1 Source" and "Pressure Mod.1 Intensity" above.

3-2 Noise Level [0...99]

Specify the volume level of the breath noise. Since this uses the signal from the noise generator, the filter of the noise generator can be used to modify the tone of the noise.

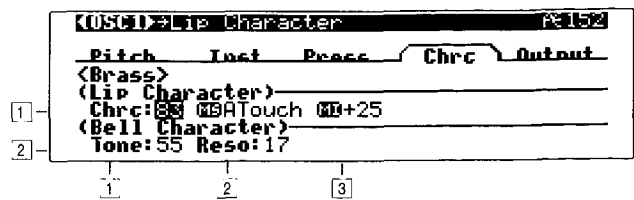

Character tab

1-1 Lip Character [0...99]

Specify the tonal change that is produced by lip position and tension. Higher settings of this value will produce a harder (more firmly blown) sound. Lower settings will produce a softer tone.

1-2 Lip Character Mod.Source (Mod.Source List 1)

Select a modulation source (see p.104) that will control "Lip Character."

1-3 Lip Character Mod.Intensity [-99...+99]

Specify the depth and direction of the effect of "Lip Character Modulation Source."

2-1 Bell Tone [0...99]

Specify the tone of the bell. As this value is increased, the low frequency portion will disappear, producing a less solid tone.

2-2 Bell Resonance [0...99]

Specify the level at which the frequency region in the area of the "Bell Tone" will be boosted. As this value is increased, the resonance effect will become stronger.

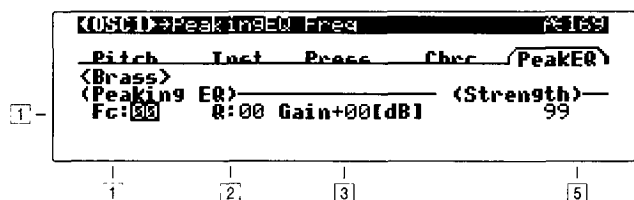

Peaking EQ tab

1-1 Peaking EQ Frequency [0...49]

Specify the center frequency of the frequency range that will be boosted or attenuated by the Peaking EQ. Increasing this value will raise the center frequency.

1-2 Peaking EQ Q [0...29]

Specify the width of the Peaking EQ frequency band. Increasing this value will narrow the frequency band that is boosted or attenuated.

1-3 Peaking EQ Gain [-18...+18 dB]

Specify the amount by which the area specified by "Peaking EQ Frequency" and "Peaking EQ Q" will be boosted or attenuated.

1-5 Strength [0...99]

Adjust the tone. Higher settings of this value will produce a overdriven sound.

Reed Model

This oscillator is a physical model which simulates a woodwind reed instrument such as a saxophone or oboe.

By using key velocity or the modulation wheel to control **Pressure** (the strength with which the reed is blown), you can use performance expressions that are very close to those of an actual woodwind instrument.

Also, by modulating the characteristics of the reed, you can produce tonal changes that correspond with the way in which a reed is blown.

Signal Flow



Reed Model

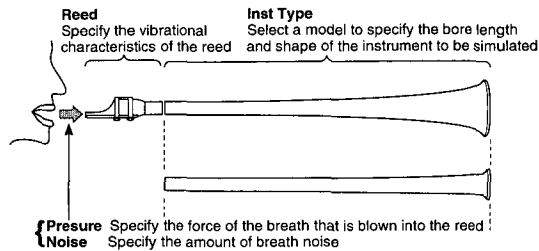

[OSC1] Instrument Type				
Pitch	Inst	Press	Reed	PeakEG
<Reed>				
<Instrument>				
#EG: Sax1				
<Bend Type>				
+: JUMP	-: JUMP			

1- [1] 2- [2]

Instrument Type tab

1-1 Inst Type [HardSax 1 ... Reed Synth]

Select the type of instrument whose bore shape and reed characteristics will be simulated.

HardSax 1, HardSax 2, HardSax 3, SoftSax 1, SoftSax 2, DoubleReed 1, DoubleReed 2, Bassoon, Clarinet, Flute 1, Flute 2, PanFlute, Ocarina, Shakuhachi, Harmonica 1, Harmonica 2, Reed Synth

2-1 Pitch Bend + [Smooth, Jump]

Specify how the pitch will change when pitch bend is applied in the + direction.

Smooth: The pitch will rise smoothly as on most synthesizers.

Jump: The pitch will jump up in steps, by varying the resonance of the bore.

2-2 Pitch Bend - [Smooth, Jump]

Specify how the pitch will change when pitch bend is applied in the - direction.

Depending on the resonant characteristics, "Pitch Bend +" and "Pitch Bend -" may not sound in some cases.

[OSC1] Pressure EG				
Pitch	Inst	Press	Reed	PeakEG
<Reed>				
<Pressure>				
#EG1: MD+99	1. MS	LFO1	MD+00	
	2. GBATouch	MD+08		
<NoiseLevel>	28			

1- [1] 2- [2] 3- [3] 4- [4]

Pressure tab

1-1 Pressure EG [EG1...EG4, A.EG]

Select the EG that will control pressure. For the settings of each EG, refer to p.57 for EG1 to 4, or to p.55 for the A.EG.

1-2 Pressure EG Intensity [-99...+99]

Specify the depth and direction of the effect of "Pressure EG" on the pressure.

1-3 Pressure Mod.1 Source (Mod.Source List 1)

Select a modulation source (see p.104) that will control pressure. If you select "After Touch," pressing down on the keyboard will produce the effect of the instrument being blown strongly. If you select "Modulation Wheel," rotating the [MOD WHEEL] in the + direction will produce this effect. In this case, setting "Pressure EG Intensity" to 0 will allow you to completely control the breath pressure by operating the specified controller.

1-4 Pressure Mod.1 Intensity [-99...+99]

Specify the depth and direction of the change in pressure controlled by "Pressure Mod.1 Source."

2-3 Pressure Mod.2 Source (Mod.Source List 1)

2-4 Pressure Mod.2 Intensity [-99...+99]

Refer to "Pressure Mod.1 Source" and "Pressure Mod.1 Intensity" above.

3-1 Noise Level [0...99]

Specify the volume level of the breath noise. Since the signal from the noise generator is used here, you can use the filter of the noise generator to modify the tone of the noise.

[OSC1] Reed Mod. Src				
Pitch	Inst	Press	Reed	PeakEG
<Reed>				
<Reed Modulation>				
	MS**OFF**	MD+00		
<Wave Shape>				
Ofst+00	Tb:CLIP	Shape:00	MS**OFF**	MD+00

1- [1] 2- [2] 3- [3] 4- [4] 5- [5]

Reed Modulation tab

1-3 Reed Mod.Source (Mod.Source List 1)

Select a modulation source (see p.104) that will modulate the characteristics of the reed.

Plucked String Model

This oscillator is a physical model which simulates a plucked string instrument such as a guitar or bass guitar. You can specify aspects of the model such as the attack waveform that is produced when the string is plucked by a pick or finger, the characteristics of the string, and the location of the pickup etc.

Signal Flow

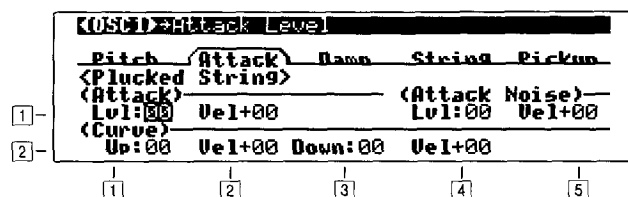
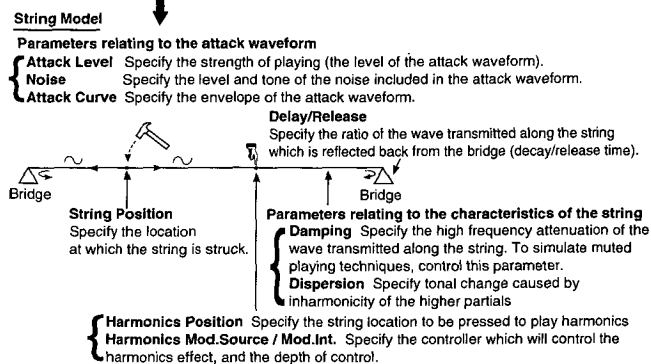
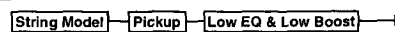

- 1-4 **Reed Mod.Intensity** [-99...+99]
Specify the depth of the modulation effect that "Reed Mod.Source" will have on the reed.
- 2-1 **Wave Shape Offset** [-99...+99]
Specify the offset value that will be added to the Reed OSC signal that is input to wave shaping.
- 2-2 **Wave Shape Table** [CLIP, RESO]
Select the wave shaping table that will be used to shape the input waveform. For details on the effect that these tables will have on the waveform, refer to the "Wave Shape" diagram (p.34) for the Standard OSC.
- 2-3 **Wave Shape** [0...99]
Specify the character of the table that will shape the input waveform. For details on how the waveform will change, refer to the "Wave Shape" diagram (p.34) for the Standard OSC.
- 2-4 **Wave Shape Mod.Source** (Mod.Source List 1)
Select a modulation source (see p.104) that will control "Wave Shape."
- 2-5 **Wave Shape Intensity** [-99...+99]
Specify the depth and direction of the effect of "Wave Shape Mod.Source."

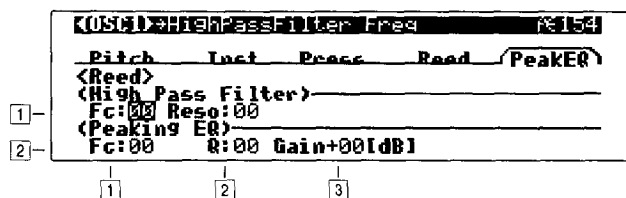

Peaking EQ tab

- 1-1 **High Pass Filter Frequency** [0...99]
Specify the cutoff frequency of the high pass filter. Raising this value will raise the cutoff frequency, causing the low range to be cut and producing a lighter-feeling sound.
- 1-2 **High Pass Filter Resonance** [0...99]
Raising this value will cause the overtones in the region of the cutoff frequency to be emphasized, adding a unique character to the sound.
- 2-1 **Peaking EQ Frequency** [0...49]
Specify the center frequency of the range that will be boosted or attenuated by the Peaking EQ. Increasing this value will raise the center frequency.
- 2-2 **Peaking EQ Q** [0...29]
Specify the width of the Peaking EQ frequency band. Increasing this value will narrow the frequency band that is boosted or attenuated.
- 2-3 **Peaking EQ Gain** [-18...+18 dB]
Specify the amount by which the range specified by "Peaking EQ Frequency" and "Peaking EQ Q" will be boosted or attenuated.

Attack tab

- 1-1 **Attack Level** [0...99]
Specify the force with which the string is plucked.
 - 1-2 **Attack Level Velocity Control** [-99...+99]
Specify the depth and direction of the effect that velocity will have on "Attack Level." The effect will be as shown in the following diagram.
-
- 1-4 **Attack Noise Level** [0...99]
Specify the level of the noise component that is included in the attack waveform. As this value is increased, a greater portion of noise will be included in the attack, and the sound will be brighter with more overtones. The noise signal used here is taken from the output of the noise generator.
 - 1-5 **Attack Noise Level Velocity Control** [-99...+99]
Specify the depth and direction of the effect that velocity will have on "Attack Noise Level." For the way in which the effect occurs, refer to "Attack Level Velocity Control."

2-1 Attack Curve Up [0...99]

Specify the steepness of the rising edge of the attack waveform.

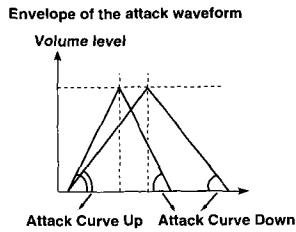

When the rising or falling edge is steep, the tone will be harder.

2-2 Attack Curve Up Velocity Control [-99...+99]

Specify the depth and direction of the effect that velocity will have on "Attack Curve Up." For details of the effect, refer to "Attack Level Velocity Control."

2-3 Attack Curve Down [0...99]

Specify the steepness of the falling edge of the attack waveform.

2-4 Attack Curve Down Velocity Control [-99...+99]

Specify the depth and direction of the effect that velocity will have on "Attack Curve Down." For details of the effect, refer to "Attack Level Velocity Control."

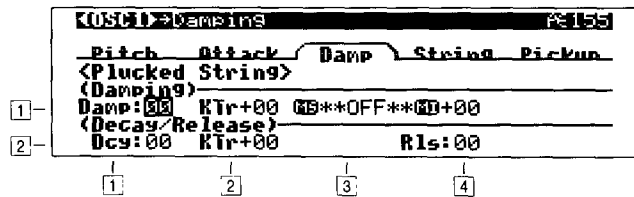

Damping tab

1-1 Damping [0...99]

Specify the amount of high frequency attenuation that will occur as a result of string quality or the way in which the string is being depressed by a finger. As this value is increased, the high frequency components of the wave that travels over the string will be dampened more greatly, producing a darker tone. In general, instruments with soft strings or which have no frets can be simulated by higher settings of "Damping," and instruments with harder strings or which have frets can be simulated by lower settings of "Damping."

1-2 Damping Keyboard Track [-99...+99]

Specify the keyboard location at which "Damping" will change. Centered at the C4 key, positive (+) settings will cause "Damping" to increase as you play higher on the keyboard, and negative (-) settings will cause "Damping" to decrease as you play higher on the keyboard.

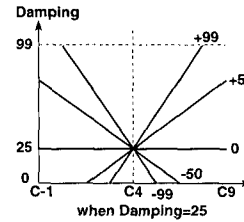
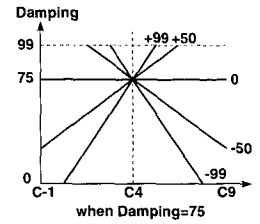
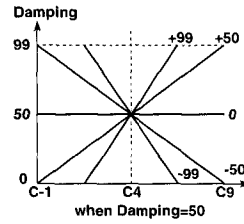

1-3 Damping Mod.Source (Mod.Source List 1)

Select a modulation source (see p.104) that will control "Damping."

1-4 Damping Mod.Intensity [-99...+99]

Specify the depth and direction of the effect that "Damping Mod.Source" will have.

2-1 Decay [0...99]

Specify the decay time over which the sound will decay if you continue pressing a note. Higher settings of this value will produce a longer decay time.

Depending on the settings of "Amplitude Modulation EG" (p55), the setting you make here may not have audible results. If you raise the EG break level and sustain level, it will be easier to hear the result of this setting.

2-2 Decay Keyboard Track [-99...+99]

Specify how keyboard position will affect "Decay." Centered on the C4 key, positive (+) settings will cause the decay to become faster as you play higher notes, and negative (-) settings will cause the decay to become slower as you play higher notes.

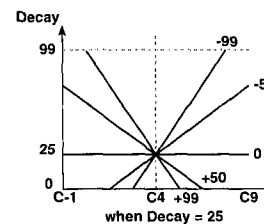
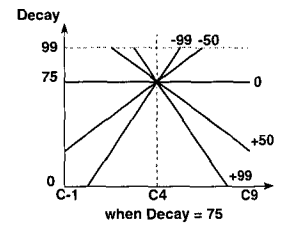
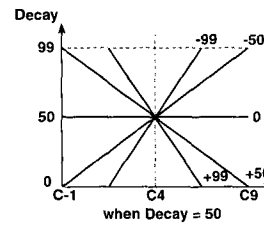

2-4 Release [0...99]
 Specify the length of time over which the sound will decay after you release the note. Higher settings of this value will produce a longer release time.

 Depending on the settings of "Amplitude Modulation EG" (p.55), the setting you make here may not have audible results. If you raise the EG release level, it will be easier to hear the result of this setting.

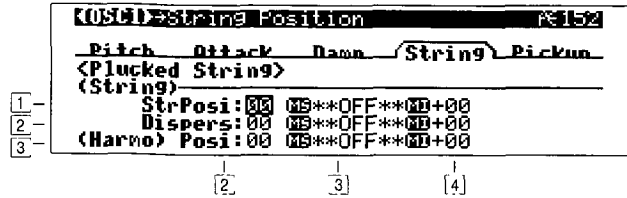

String tab

1-2 String Position [0...99]
 Specify the location at which the string will be plucked. A setting of 0 is the end of the string, 50 is the middle of the string, and 99 is the other end of the string.

1-3 String Position Mod.Source (Mod.Source List 1)
 Select a modulation source (see p.104) that will control "String Position."

1-4 String Position Mod.Intensity [-99...+99]
 Specify the depth and direction of the effect of "String Position Mod.Source."

2-2 Dispersion [0...99]
 Specify the inharmonicity of the higher partials relative to the fundamental. With a value of 0, the partials will be located at integer (whole number) multiples of the fundamental. As this value is increased, the partials will move further away from integer multiple locations. In general, thin and flexible strings can be simulated by a low "Dispersion" value, and thick and stiff strings can be simulated by a high "Dispersion" value.

 If this value is raised excessively, the pitch may become unstable.

2-3 Dispersion Mod.Source (Mod.Source List 1)
 Select a modulation source (see p.104) that will control "Dispersion."

2-4 Dispersion Mod. Intensity [-99...+99]
 Specify the depth and direction of the effect of "Dispersion Mod. Source."

3-2 Harmonics Position [0...99]
 Specify the location at which the string will be pressed to play harmonics.

3-3 Harmonics Mod.Source (Mod.Source List 1)
 Select a modulation source (see p.104) that will control the harmonics effect.

3-4 Harmonics Mod.Intensity [-99...+99]
 Specify the depth and direction of the control that "Harmonics Mod. Source" will have on the harmonics effect.

 In order to make "Harmonics Position" settings, you must assign "Harmonics Mod.Source" to a controller other than OFF, and raise the "Harmonics Mod.Intensity" value. Even if the "Harmonics Position" setting is identical, the effect will differ depending on the note that you play.

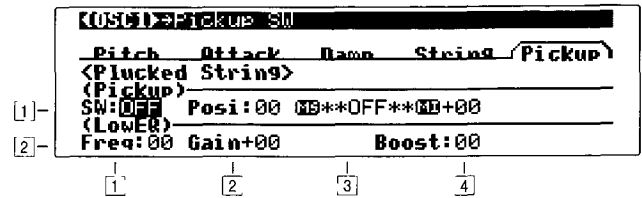

Pickup tab

1-1 Pickup Switch [OFF, ON]
 With a setting of ON, the sound that passes through a pickup will be simulated. With a setting of OFF, the sound will not pass through the pickup.

1-2 Pickup Position [0...99]
 Adjust the change in tone that results from differences in pickup location.

1-3 Pickup Position Mod.Source (Mod.Source List 1)
 Select a modulation source (see p104) that will control "Pickup Character."

1-4 Pickup Position Mod.Intensity [-99...+99]
 Specify the depth and direction of the effect of "Pickup Character Mod.Source."

 The parameters "Pickup Position," "Pickup Position Mod.Source" and "Pickup Position Mod.Intensity" are valid only when the "Pickup Switch" is ON.

2-1 Low EQ Freq [0...49]
 Specify the cutoff frequency of the Low EQ.

2-2 Low EQ Gain [-18...+18 dB]
 Specify the gain of the Low EQ.

2-4 Low Boost [0...99]
 Specify how the low frequency range will be emphasized. Raising this value will cause the low frequency range to be emphasized more strongly.

Bowed String Model

This oscillator is a physical model which simulates the sound of a bowed string instrument such as a violin or cello. By controlling the bowing speed and the bowing pressure, you can create performance expressions that are very close to those of an actual bowed string instrument.

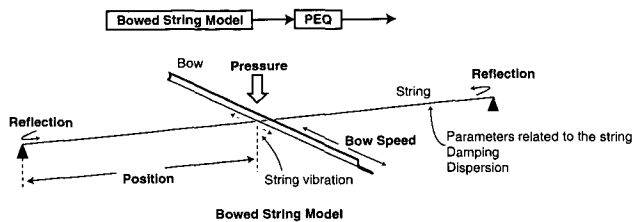

```

[0501] > Speed EG
-----
Pitch Bow Damp String Ref
<Bowed String>
(Bow Speed) EG1 00+00 1. 00**OFF**00+00
(Bif: OFF) 2. 00**OFF**00+00
(Bow Pressure)
EG1 00+00 00**OFF**00+00 Rosin: 00
-----
1 2 3 4 5
  
```

Bow tab

1-2 Bow Speed EG [EG1...EG4, A.EG]

Select the EG which will control bowing speed (the speed at which the bow moves across the string).

1-3 Bow Speed EG Intensity [-99...+99]

Specify the depth and direction of the effect of "Bow Speed EG." With negative (-) settings, the direction of the bow speed will be inverted.

1-4 Bow Speed Mod.1 Source (Mod.Source List 1)

Select a modulation source (see p.104 that will control bowing speed.

Instead of using an EG to modify the bowing speed, you can use the [X-Y PAD] or [MOD WHEEL] to simulate bowing without using an EG.

1-5 Bow Speed Mod.1 Intensity [-99...+99]

Specify the depth and direction of the effect of "Bow Speed Mod.1 Source."

2-4 Bow Speed Mod.2 Source (Mod.Source List 1)

2-5 Bow Speed Mod.2 Intensity [-99...+99]

Refer to "Bow Speed Mod.1 Source" and "Bow Speed Mod.1 Intensity" above.

2-1 Speed Differential [OFF, ON]

With a setting of OFF, the values of "Bow Speed EG," "Bow Speed Mod.1 Source" and "Bow Speed Mod.2 Source" will by themselves determine the speed of bowing. Normally, if you are using an EG to control bowing, you will turn this OFF.

With a setting of ON, the values of "Bow Speed EG," "Bow Speed Mod.1 Source" and "Bow Speed Mod.2 Source" will be differentiated, and the amount of change in value will be used as the bowing speed.

Using the [X-Y PAD] to control bowing speed

Here we will discuss the example of when "Bow Speed Mod.1 Source" is set to X[+/-]. So that the [X-Y PAD] alone will control bowing speed, raise the "Bow Speed Mod.1 Intensity" value, and set "Bow Speed EG Intensity" and "Bow Speed Mod.2 Intensity" to 0.

Turn "Speed Differential" ON. When your finger is resting on [X-Y PAD], the bowing speed will be 0 and there will be no sound. When you slide your finger on the [X-Y PAD] in the +X direction (the differential value will be positive), the bowing speed will correspond to the speed at which you slide your finger, and sound will be produced. As you slide your finger back and forth between +X and -X, the bowing speed will change between positive → 0 → negative → 0 → positive, allowing you to produce performance expressions similar to when an actual bow is used.

3-1 Pressure EG [EG1...EG4, A.EG]

Select the EG which will control the pressure of the bow on the string (bow pressure).

3-2 Pressure EG intensity [-99...+99]

Specify the depth and direction of the effect that the "Pressure EG" will have on bow pressure. If this value is low, the bow will rest lightly on the string.

3-3 Pressure Mod.Source (Mod.Source List 1)

Select a modulation source (see p.104) that will control bow pressure.

3-4 Pressure Mod.Intensity [-99...+99]

Specify the depth of the effect produced by "Pressure Mod.Source."

3-5 Rosin Amount [0...99]

Specify the coefficient of static friction between the bow and the string. (This corresponds to the amount of rosin on the bow.)

Higher values will increase the friction between the bow and string. When this value is in the region of 0, it will be difficult for playing strength to be transmitted to the string.

```

[0501] > Damping
-----
Pitch Bow Damp String Ref
<Bowed String>
(Damping)
Damp: 00 00**OFF**00+00
(Damping Slope)
Key: C-1 LS+00 HS+00
-----
1 2 3 4 5
  
```

Damping tab

1-2 Damping [0...99]

Specify the amount of high frequency attenuation that is produced by the characteristics of the string or by the way in which the finger is pressing the string. As this value is increased, the high frequency components of the wave traveling on the string will be attenuated more heavily, making the sound darker. In general,

higher "Damping" values will simulate an instrument with flexible strings or an instrument without frets, and lower "Damping" values will simulate an instrument with stiff strings or an instrument with frets.

- 1-3 Damping Mod.Source** (Mod.Source List 1)
Select a modulation source (see p.104) that will control "Damping."
- 1-4 Damping Mod.Intensity** [-99...+99]
Specify the depth and direction of the effect of "Damping Mod.Source."
- 2-3 Damping KTr Key** [C-1...G9]
Specify the key above and below which keyboard tracking will begin to apply to the "Damping" effect.
- 2-4 Damping KTr Low Intensity** [-99...+99]
Specify the depth and direction in which the "Damping" amount will change for notes below the "Damping KTr Key." Positive (+) settings will cause "Damping" to increase for notes below the "Damping KTr Key." Negative (-) settings will cause "Damping" to decrease for notes below the "Damping KTr Key."
- 2-5 Damping KTr High Intensity** [-99...+99]
Specify the depth and direction in which the "Damping" amount will change for notes above the "Damping KTr Key." Positive (+) settings will cause "Damping" to increase for notes above the "Damping KTr Key." Negative (-) settings will cause "Damping" to decrease for notes above the "Damping KTr Key."

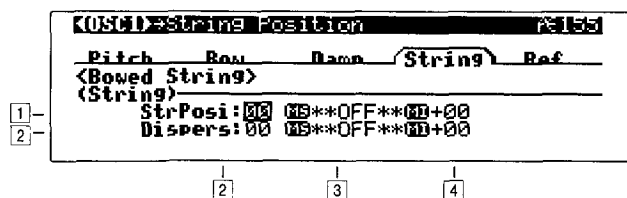

String tab

- 1-2 String Position** [0...99]
Specify the location at which the bow contacts the string. A setting of 0 is the end of the string, 50 is near the middle, and 99 is at the other end.
- 1-3 String Position Mod.Source** (Mod.Source List 1)
Select a modulation source (see p.104) that will control "String Position."
Changing the location at which the string is bowed will also change the overtone structure.
- 1-4 String Position Mod.Intensity** [-99...+99]
Specify the depth and direction of the effect of "String Position Mod.Source."
- 2-2 Dispersion** [0...99]
Specify the inharmonicity of the higher partials relative to the fundamental. With a value of 0, the partials will be located at integer (whole number)x mul-

tiples of the fundamental. As this value is increased, the partials will move further away from integer multiple locations. In general, thin and flexible strings can be simulated by a low "Dispersion" value, and thick and stiff strings can be simulated by a high "Dispersion" value.

 If this value is raised excessively, the pitch may become unstable.

- 2-3 Dispersion Mod.Source** (Mod.Source List 1)
Select a modulation source (see p.104) that will control "Dispersion."
- 2-4 Dispersion Mod. Intensity** [-99...+99]
Specify the depth and direction of the effect of "Dispersion Mod. Source."

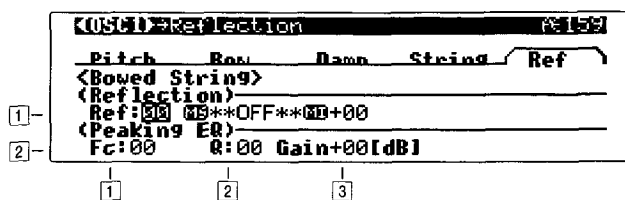

Reflection tab

- 1-2 Reflection** [0...99]
Specify the amount of the wave that will be reflected at the end of the string. Higher values will make the notes sound more easily. With a setting of 0 there will be no reflection at all.
- 1-3 Reflection Mod.Source** (Mod.Source List 1)
Select a modulation source (see p.104) that will control "Reflection."
- 1-4 Reflection Mod.Intensity** [-99...+99]
Specify the depth and direction of the effect of "Reflection Mod.Source."
- 2-1 PEQ Freq** [0...49]
Specify the center frequency at which the peaking EQ will boost (attenuate) the sound.
- 2-2 PEQ Q** [0...29]
Specify the width of the region that will be boosted (attenuated) by the peaking EQ. With a setting of 0, a wide region will be affected. With a setting of 29, only a narrow region close to the center frequency will be boosted (attenuated).
- 2-3 PEQ Gain** [-18...+18 dB]
Specify the gain by which the peaking EQ will boost or attenuate.

Sub Oscillator page

Sub Oscillator

The sub oscillator allows you to select one of four basic waveforms. In the mixer section, the signal of the sub oscillator is mixed with the signals of oscillators 1 and 2.

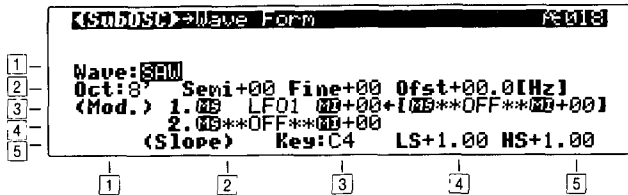

□ Specifying the waveform of the sub oscillator

1-1 Wave Form [SAW, SQU, TRI, SIN]
 Select the waveform of the sub oscillator.

□ Specifying the basic pitch of the sub oscillator

2-1 Octave [32'...4']
 Specify the basic pitch of the sub oscillator in octave units. A setting of 32' is two octaves down, 16' is one octave down, 8' is the basic pitch, and 4' is an octave above.

2-2 Semi Tone [-12...+12]
 Specify an adjustment in semitone steps to the basic pitch specified by "Octave."

2-3 Fine Tune [-50...+50 cents]
 Make fine adjustments in 1-cent steps to the basic pitch.

2-4 Frequency Offset [-10.0...+10.0 Hz]
 Make fine adjustments in 0.1 Hz steps to the basic pitch.

□ Modifying the pitch of the sub oscillator (Pitch Modulation)

Pitch modulation of the sub oscillator can be controlled in the same way as pitch modulation of oscillator 1 (see p.31).

3-1 Pitch Mod.1 Source (Mod.Source List 1)

3-2 Pitch Mod.1 Intensity [-99...+99]

3-3 Pitch Mod.1 Int.Controller (Mod.Source List 1)

3-4 Pitch Mod.1 Int.Control Intensity [-99...+99]

4-1 Pitch Mod.2 Source (Mod.Source List 1)

4-2 Pitch Mod.2 Intensity [-99...+99]

□ Specifying how the pitch of the sub oscillator will correspond to the note of the keyboard (Pitch Slope)

The pitch slope of the sub oscillator can be controlled in the same way as the pitch slope of oscillator 1. (Refer to p.32.)

5-3 Center Key [C-1...G9]

5-4 Lower Slope [-1.00...+2.00]

5-5 Higher Slope [-1.00...+2.00]

Noise Generator page

Noise Generator

The noise generator produces white noise. The noise signal that is generated passes through a dedicated filter, and is mixed by the mixer section with the signals from the sub oscillator and oscillators 1 and 2.

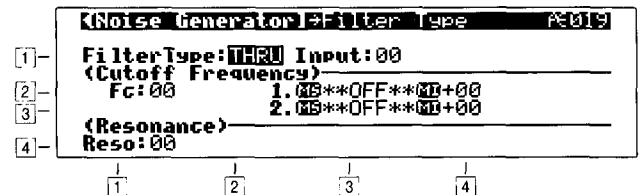
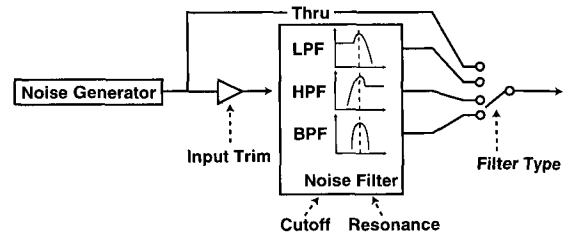

□ Noise generator settings

1-2 Noise Filter Type [THRU, LPF, HPF, BPF]
 Specify the type of filter that will be applied to the output from the noise generator.

1-3 Noise Filter Input Trim [0...99]
 Specify the input level to the dedicated noise filter. If the "Noise Filter Type" is THRU, this parameter will have no effect.

2-1 Noise Filter Cutoff [0...99]
 Specify the cutoff frequency of the noise signal filter. For the characteristics of each filter type, refer to the Filter section (p.53).

2-3 Noise Filter Cutoff Mod.1 Source (Mod.Source List 1)
 Select a modulation source (see p.104) that will control the "Noise Filter Cutoff."

2-4 Noise Filter Cutoff Mod.1 Intensity [-99...+99]
 Specify the depth and direction of the effect of "Noise Filter Cutoff Mod.1 Source."

3-3 Noise Filter Cutoff Mod.2 Source (Mod.Source List 1)

3-4 Noise Filter Cutoff Mod.2 Intensity [-99...+99]
 Refer to "Noise Filter Cutoff Mod.1 Source" and "Noise Filter Cutoff Mod.1 Intensity" above.

4-1 Noise Filter Resonance [0...99]
 This boosts the frequency region specified by the "Noise Filter Cutoff" to add character to the sound. Since the filter characteristics differ from the filter type of the "Filter section (p.53), the resulting effect will be different even if "Filter Type," "Filter Cutoff" and "Resonance" settings are identical.

2. Prog Mixer section

In the Prog Mixer section, the signal levels from oscillators 1 and 2, the sub oscillator, the noise generator, and feedback are adjusted, and output to the Filter section.

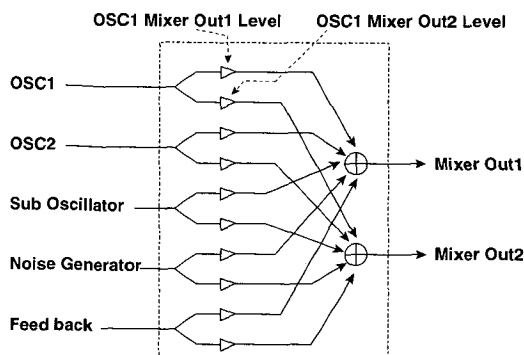

Mix Level page

Adjusting the levels that are sent to Mixer Outputs 1/2

In this page you can adjust the levels at which oscillator 1 (OSC1), oscillator 2 (OSC2), the sub-oscillator (SubOSC), noise generator (Noise), and feedback (Feedback) will be sent to mixer outputs 1 and 2.

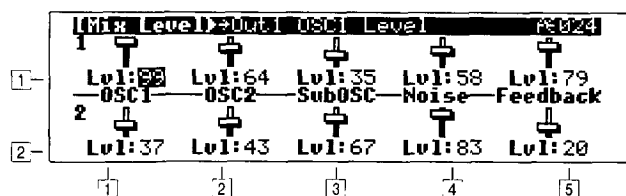

- 1-1 **OSC1 Output 1 Level** [0...99]
Specify the signal level of oscillator 1 that will be output to mixer output 1.
- 2-1 **OSC1 Output 2 Level** [0...99]
Specify the signal level of oscillator 1 that will be output to mixer output 2.
- 1-2 **OSC2 Output 1 Level** [0...99]
- 2-2 **OSC2 Output 2 Level** [0...99]
Specify the signal levels of oscillator 2 that will be output to mixer outputs 1 and 2.
- 1-3 **SubOSC Output 1 Level** [0...99]
- 2-3 **SubOSC Output 2 Level** [0...99]
Specify the signal levels of the sub-oscillator that will be output to mixer outputs 1 and 2.

- 1-4 **Noise Output 1 Level** [0...99]
- 2-4 **Noise Output 2 Level** [0...99]
Specify the signal levels of the noise generator that will be output to mixer outputs 1 and 2.
- 1-5 **Feedback Output 1 Level** [0...99]
- 2-5 **Feedback Output 2 Level** [0...99]
Specify the signal levels of the feedback from the AMP section that will be output to mixer outputs 1 and 2.

▲ If the Filter section "Filter Routing" setting is SERIAL2, Mixer Output 2 will not be available (see p.52).

Mix Mod. page

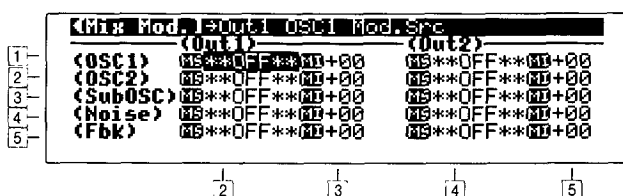

Specify the modulation source and intensity that will control each output level

- 1-2 **OSC1 Output 1 Mod.Source** (Mod.Source List 1)
Select a modulation source (see p.104) that will control "OSC1 Output 1 Level"
- 1-3 **OSC1 Output 1 Mod.Intensity** [-99...+99]
Specify the depth and direction of the effect of "OSC1 Output 1 Mod.Source."
- 1-4 **OSC1 Output 2 Mod.Source** (Mod.Source List 1)
- 1-4 **OSC1 Output 2 Mod.Intensity** [-99...+99]
Select a modulation source that will control "OSC1 Output 2 Level" and specify the intensity.
- 2-2 **OSC2 Output 1 Mod.Source** (Mod.Source List 1)
- 2-3 **OSC2 Output 1 Mod.Intensity** [-99...+99]
Select a modulation source that will control "OSC2 Output 1 Level" and specify the intensity.
- 2-4 **OSC2 Output 2 Mod.Source** (Mod.Source List 1)
- 2-5 **OSC2 Output 2 Mod.Intensity** [-99...+99]
Select a modulation source that will control "OSC2 Output 2 Level" and specify the intensity.
- 3-2 **Sub Output 1 Mod.Source** (Mod.Source List 1)
- 3-3 **Sub Output 1 Mod.Intensity** [-99...+99]
Select a modulation source that will control "SubOSC Output 1 Level" and specify the intensity.

- 3-4 Sub Output 2 Mod.Source (Mod.Source List 1)
- 3-5 Sub Output 2 Mod.Intensity [-99...+99]
Select a modulation source that will control "SubOSC Output 2 Level" and specify the intensity.

- 4-2 Noise Output 1 Mod.Source (Mod.Source List 1)
- 4-3 Noise Output 1 Mod.Intensity [-99...+99]
Select a modulation source that will control "Noise Output 1 Level" and specify the intensity.

- 4-4 Noise Output 2 Mod.Source (Mod.Source List 1)
- 4-5 Noise Output 2 Mod.Intensity [-99...+99]
Select a modulation source that will control "Noise Output 2 Level" and specify the intensity.

- 4-2 Feedback Output 1 Mod.Source (Mod.Source List 1)
- 4-3 Feedback Output 1 Mod.Intensity [-99...+99]
Select a modulation source that will control "Feedback Output 1 Level" and specify the intensity.

- 4-4 Feedback Output 2 Mod.Source (Mod.Source List 1)
- 4-5 Feedback Output 2 Mod.Intensity [-99...+99]
Select a modulation source that will control "Feedback Output 2 Level" and specify the intensity.

 Raising the feedback level excessively may cause the sound to distort.

3. Filter section

This section contains two multi-mode filters. For each filter, you can select one of five filter types.

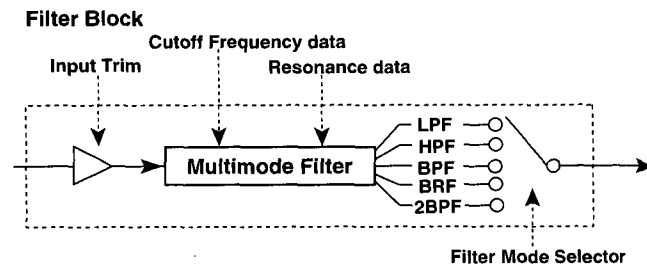

Filter Routing page

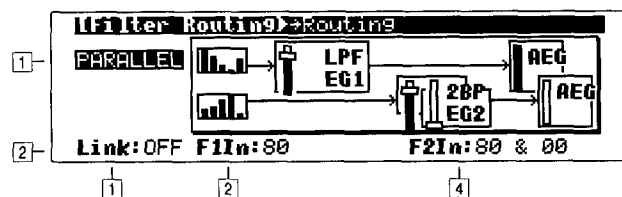

Specify the filter routing

1-1 Filter Routing [SERIAL1, SERIAL2, PARALLEL]

Specify how filters 1 and 2 will be connected.

One of the following three types of routing connections from mixer output → filter → amp can be selected.

Serial1

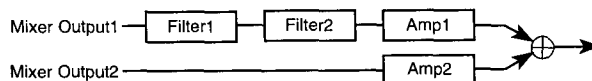

Serial2

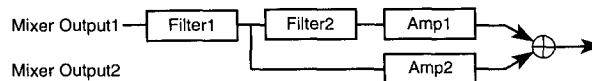

Parallel

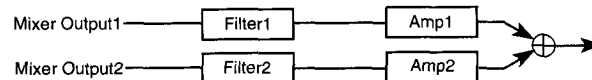

2-1 Filter 1 & 2 Link Switch [OFF, ON]

With a setting of ON, filter 2 will be linked to filter 1, and the settings of filter 2 will be the same as for filter 1.

 When this is ON, filter 2 settings cannot be made.

2-2 Filter 1 Input Trim [0...99]

2-4 Filter 2 Input Trim [0...99]

Refer to p.53.

Filter 1 page

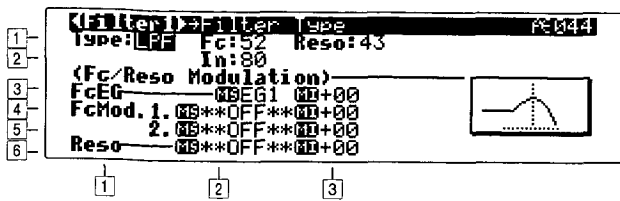

Specify the type and cutoff frequency of filter 1 (Filter 1)

1-1 Filter Type [LPF, HPF, BPF, BRF, 2BPF]

Select the filter type that will be used by filter 1. Select the filter type, and then press the [ENTER] key.

Filter Types and Cutoff Frequency

LPF (Low Pass Filter)

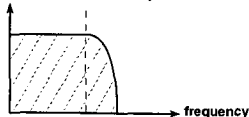

A low pass filter is the most commonly-used type of filter, and passes the range of frequencies that lie below the cutoff frequency, and cuts the high range. Cutting the higher partials will cause a bright sound to become darker (more mellow).

HPF (High Pass Filter)

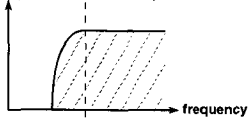

A high pass filter passes the range of frequencies that lie above the cutoff frequency, and cuts the low range. This type of filter is used when you wish to make the sound thinner. However, raising the cutoff frequency excessively will drastically reduce the volume.

BPF (Band Pass Filter)

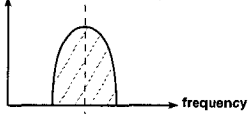

A band pass filter passes the range of frequencies in the vicinity of the cutoff frequency, and cuts the ranges above and below. This type of filter is used when you wish to emphasize a particular portion of the sound.

BRF (Band Reject Filter)

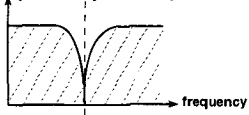

A band reject filter cuts only the range in the vicinity of the cutoff frequency, and passes the rest of the sound. This type of filter gives a unique character to the sound.

2BPF (Dual Band Pass Filter)

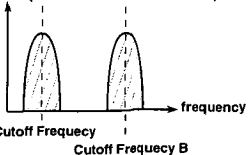

The dual band pass filter places two band pass filters in parallel. It allows you to simulate sounds such as human voice and the body resonances of a violin or guitar.

If 2BPF is selected, the parameters explained in "Filter B settings when 2BPF is selected" (p.54) will be displayed.

2-1 Input Trim [0...99]

Specify the level of the input to filter 1.

If this value is raised, the sound may become distorted if the resonance setting is high, etc.

1-2 Cutoff Frequency [0...99]

Specify the cutoff frequency of filter 1. As this value is increased, the cutoff frequency will rise.

Since the BPF and 2BPF filter types use filters with differing characteristics, their actual cutoff frequency may differ even if their settings are identical.

3-2 Cutoff Frequency Mod. EG [EG1...EG4, A. EG]

Select the EG that will create time-varying change in the cutoff frequency of filter 1.

3-3 Cutoff Frequency Mod. EG Intensity [-99...+99]

Specify the depth and direction of the control that "Cutoff Frequency Mod. EG" will have on the cutoff frequency. With positive (+) settings of this parameter, the tone will become brighter when the various EG levels rise into the + area (the setting of the "Cutoff Frequency" will be reached when the EG levels are at 0), and darker when the EG levels fall into the - area. With negative (-) settings of this parameter, the tonal change will take place in the opposite direction.

4-2 Cutoff Frequency Mod.1 Source (Mod.Source List 1)

Select a modulation source (see p.104) that will control the cutoff frequency.

4-3 Cutoff Frequency Mod.1 Intensity [-99...+99]

Specify the depth and direction of the effect that "Cutoff Frequency Mod.1 Source" will have on the cutoff frequency.

5-2 Cutoff Frequency Mod.2 Source (Mod.Source List 1)

5-3 Cutoff Frequency Mod.2 Intensity [-99...+99]

Refer to "Cutoff Frequency Mod.1 Source" and "Cutoff Frequency Mod.1 Intensity."

Using Resonance to add character to the sound

1-3 Resonance [0...99]

This setting emphasizes the overtones in the region of the "Cutoff Frequency" to add character to the sound. Higher values will produce a stronger effect. With high settings of resonance, the output signal of the filter may distort. If this occurs, reduce the "Input Trim" setting.

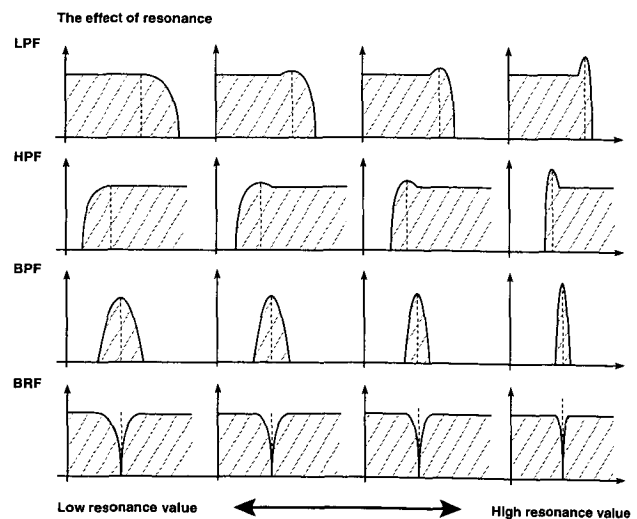

With the 2BPF filter type, the overtones in the vicinity of each cutoff frequency will be affected in the same way as by a BPF.

6-2 Resonance Mod.Source (Mod.Source List 1)

Select a modulation source (see p.104) that will control the amount of resonance.

6-3 Resonance Mod.Intensity [-99...+99]

Specify the depth and direction of the effect that "Resonance Mod.Source" will have on the amount of resonance.

.....
Filter 1 Fc Kbd page

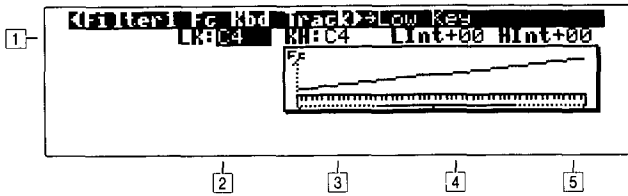

Specify how the brightness will be affected by keyboard position (Cutoff Keyboard Track)

Keyboard tracking settings specify how the cutoff frequency of filter 1 will be varied according to keyboard position.

1-2 Low Key [C-1...G9]

Specify the key at which Lower keyboard tracking will begin.

1-3 High Key [C-1...G9]

Specify the key at which Higher keyboard tracking will begin.

1-4 Lower Intensity [-99...+99]

Specify the depth and direction of cutoff frequency change that will occur below the "Low Key." With a setting of -50, the change will match the change in pitch.

1-5 Higher Intensity [-99...+99]

Specify the depth and direction of cutoff frequency change that will occur above the "High Key." With a setting of +50, the change will match the change in pitch.

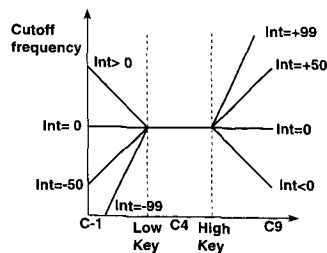

Filter B settings when 2BPF is selected

When 2BPF is selected as the "Filter Type," the following group of parameters will also be available. You can specify the cutoff frequency and resonance of filter B, and make settings for modulation sources and keyboard tracking.

1-4 Cutoff Frequency [0...99]

2-4 Input Trim [0...99]

(Cutoff-B Modulation)

3-4 Cutoff Frequency Mod. EG Int [-99...+99]

4-4 Cutoff Frequency Mod. 1 Int [-99...+99]

5-4 Cutoff Frequency Mod. 2 Int [-99...+99]

(Resonance-B)

1-5 Resonance [0...99]

6-4 Resonance Mod.Intensity [-99...+99]

(Cutoff-B Keyboard Track)

2-2 Low Key [C-1...G9]

2-3 High Key [C-1...G9]

2-4 Lower Intensity [-99...+99]

2-5 Higher Intensity [-99...+99]

.....
Filter 2 / Filter 2 Fc Kbd pages

Here you can make settings for filter 2. Refer to "Filter 1 page" and "Filter 1 Fc Kbd page."

4. AMP (Amplifier) section

In the AMP (Amplifier) section you can make volume-related settings. There are two independent amps, and the signal that enters the AMP section is determined by the "Filter Routing" setting of the Filter section (see p.52).

Amplitude page

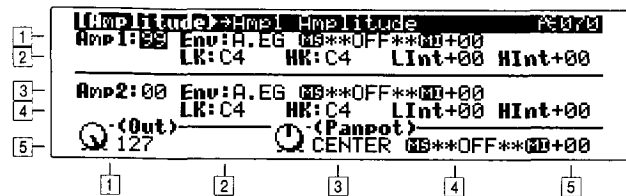

Specify the volume level of amp 1 (Amp 1)

1-1 Amplitude [0...99]
Specify the volume level of amp 1. The input signal to amp 1 is determined by the "Filter Routing" setting of the Filter section (see p.52).

Control the volume level of amp 1 (Amplitude Modulation)

1-2 Amplitude Mod. EG [EG1...EG4, A.EG]
Select the EG that will create time-variant change in the volume level of amp 1. For the settings of each EG, refer to p.55 and 56.

1-3 Amplitude Mod. Source (Mod. Source List 1)
Select a modulation source (see p.104) that will control the volume level of amp 1.

1-4 Amplitude Mod. Intensity [-99...+99]
Specify the depth and direction of the effect of "Amplitude Modulation Source" on the volume level.

Specify how volume will be affected by keyboard position (Amp Keyboard Track)

2-2 Low Key [C-1...G9]
Specify the key at which Lower keyboard tracking will begin.

2-3 High Key [C-1...G9]
Specify the key at which Higher keyboard tracking will begin.

2-4 Lower Intensity [-99...+99]
Specify the way in which keyboard tracking will affect the volume of notes below the Low Key.

2-5 Higher Intensity [-99...+99]
Specify the way in which keyboard tracking will affect the volume of notes below the High Key.

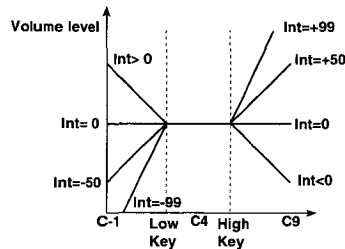

Settings for amp 2 (Amp 2)

Here you can make settings for amp 2. Amp 2 has the same parameters as amp 1.

Specify the output level (Output)

5-1 Output Level [0...127]
Specify the output level following the AMP section.

Specify the stereo location (Panpot)

5-3 Panpot [0...127]
Specify the panning of the sound following the AMP section.

5-4 Panpot Mod. Source (Mod. Source List 1)
Select a modulation source (see p.104) that will control "Panpot."

5-5 Panpot Mod. Intensity [-99...+99]
Specify the depth and direction in which "Panpot Mod. Source" will affect the panning.

Amp EG page

Amp EG settings (Amp EG)

Here you can make settings for the amp EG. The amp EG lets you specify how the sound will change over time. Since the amp EG can also be used as a general-purpose controller, it can create time-variant change in parameters other than volume.

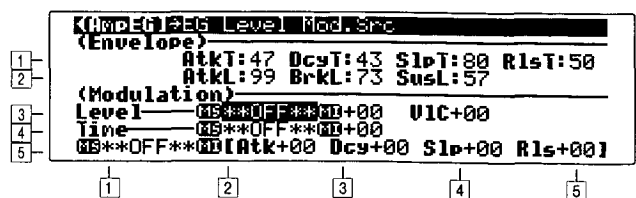

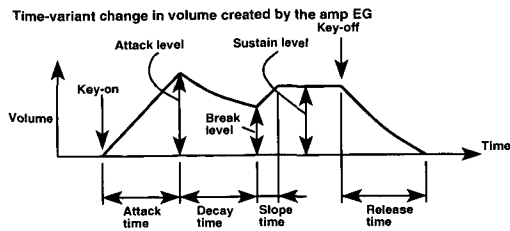

1-2 Attack Time [0...99]
 Specify the time from key-on (when a note is played) until the volume reaches the attack level. With a value of 0, the volume will change instantly. With a value of 99, the volume will change slowly.

2-2 Attack Level [0...99]
 Specify the volume that will be reached after the Attack Time has elapsed.

1-3 Decay Time [0...99]
 Specify the time from when the attack time ends until the break level is reached.

2-3 Break Level [0...99]
 Specify the volume level that will be reached after the Decay Time has elapsed.

1-4 Slope Time [0...99]
 Specify the time from when the decay time ends until the sustain level is reached.

2-4 Sustain Level [0...99]
 Specify the volume level that will be reached after the Slope Time has elapsed.

1-5 Release Time [0...99]
 Specify the time from key-off (when a note is released) until the volume falls to zero.

3-2 EG Level Mod.Source (Mod.Source List 1)
 Select a modulation source (see p.104) that will control the level of the amp EG.

3-3 EG Level Mod.Intensity [-99...+99]
 Specify the depth and direction of the effect that "EG Level Mod.Source" will have on the level of the amp EG.

3-4 EG Level Velocity Control [-99...+99]
 Specify the depth and direction of the effect that velocity will have on the level of the amp EG.

When "EG Level Velocity Control" is set to a positive (+) value

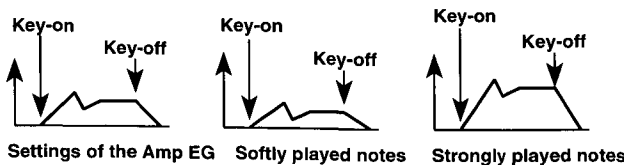

4-2 EG Time Mod.Source (Mod.Source List 1)
 Select a modulation source (see p.104) that will control the amp EG times.

4-3 EG Time Mod.Intensity [-99...+99]
 Specify the depth and direction of the effect that "EG Time Mod.Source" will have on the amp EG times.

5-1 Node Time Mod.Source (Mod.Source List 1)
 Select a modulation source (see p.104) that will control the amp EG times.

5-2 Attack Time Mod. Intensity [-99...+99]

5-3 Decay Time Mod. Intensity [-99...+99]

5-4 Slope Time Mod. Intensity [-99...+99]

5-5 Release Time Mod. Intensity [-99...+99]
 Specify the depth and direction of the effect that "Node Time Mod.Source" will have on each EG time.

When the various EG times are set to negative (-) values

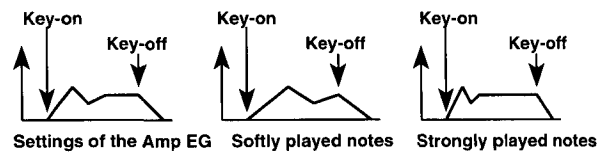

5. EG section

This section provides four general purpose EGs (envelope generators). The four EGs can be used as modulation sources for the parameters of other sections to create time-variant change in the sound.

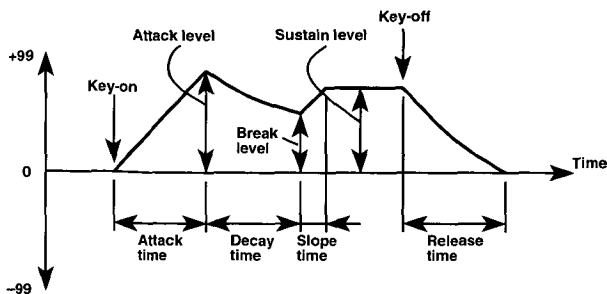

EG1 page

1	[EG1] EG Level Mod. Src				
2	(Envelope)				
	AtkT:60	DcyT:54	SlpT:64	RlsT:38	
	Stal:-62	AtkL:+99	BrkL:+28	SusL:+58	RlsL:+00
3	(Modulation)				
4	Level	GS**OFF**00+00	VIC+00		
5	Time	GS**OFF**00+00			
		GS**OFF**00+00			

Settings for the general-purpose EGs

- 2-1 Start Level** [-99...+99]
Specify the value at the time of key-on.
- 1-2 Attack Time** [0...99]
Specify the time from key-on (when a note is played) until the value reaches the attack level. With a value of 0, the value will change instantly. With a value of 99, the value will change slowly.
- 2-2 Attack Level** [-99...+99]
Specify the value that will be reached after the Attack Time has elapsed.
- 1-3 Decay Time** [0...99]
Specify the time from when the attack time ends until the Break Level is reached.
- 2-3 Break Level** [-99...+99]
Specify the value that will be reached after the Decay Time has elapsed.
- 1-4 Slope Time** [0...99]
Specify the time from when the decay time ends until the Sustain Level is reached.
- 2-4 Sustain Level** [-99...+99]
Specify the value that will be reached after the Slope Time has elapsed.
- 1-5 Release Time** [0...99]
Specify the time from key-off (when a note is released) until the Release Level is reached.

- 2-5 Release Level** [-99...+99]
Specify the value that will be reached after the Release Time has elapsed.
- 3-2 EG Level Mod.Source** (Mod.Source List 1)
Select a modulation source (see p.104) that will control the level of EG1.
- 3-3 EG Level Mod.Intensity** [-99...+99]
Specify the depth and direction of the effect that "EG Level Mod.Source" will have on the EG levels.
- 3-4 EG Level Velocity Control** [-99...+99]
Specify the depth and direction of the effect that velocity will have on the EG levels.

When "EG Level Velocity Control" is set to a positive (+) value

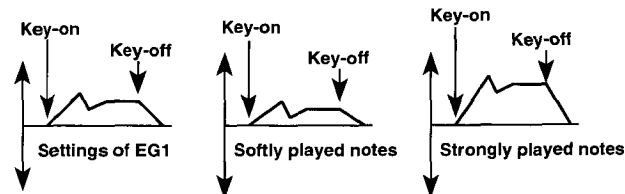

- 4-2 EG Time Mod.Source** (Mod.Source List 1)
Select a modulation source (see p.104) that will control the EG1 times.
- 4-3 EG Time Mod.Intensity** [-99...+99]
Specify the depth and direction of the effect that "EG Time Mod.Source" will have on the EG times.
- 5-1 Node Time Mod.Source** (Mod.Source List 1)
Select a modulation source (see p.104) that will control the EG1 times.
- 5-2 Attack Time Mod. Intensity** [-99...+99]
- 5-3 Decay Time Mod. Intensity** [-99...+99]
- 5-4 Slope Time Mod. Intensity** [-99...+99]
- 5-5 Release Time Mod. Intensity** [-99...+99]
Specify the depth and direction of the effect that "Node Time Mod.Source" will have on each EG time.

When the various EG times are set to negative (-) values

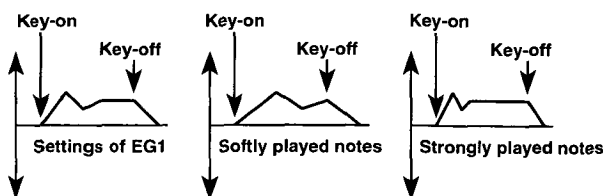

EG2 / EG3 / EG4 pages

EG2, EG3 and EG4 have the same parameters as EG1. Refer to "EG1 page."



6. LFO section

This section provides four LFOs (Low Frequency Oscillators). These LFOs can be used as modulation sources for parameters of other sections, to create cyclic changes in the sound.



LFO1 page

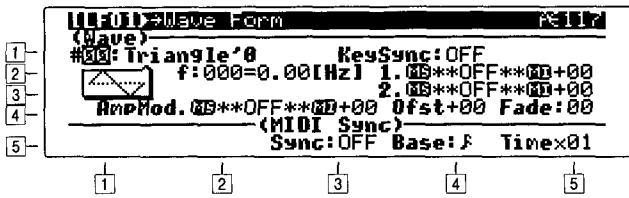

Settings for the general-purpose LFOs

1-1 Wave Form [Triangle '0...ExpSawDown]
Select the LFO waveform.

0: Triangle '0		Random 2 changes in a straight line toward a value which is determined randomly every 1/2 cycle.
1: Triangle '90		
2: Tri Random		When Key Sync=ON, the starting phase will vary randomly.
3: Sine		11: Step Tri 4
4: Saw Up '0		12: Step Tri 6
5: Saw Up '180		13: Step Saw 4
6: Saw Down '0		14: Step Saw 6
7: Saw Down '180		15: Exp Tri
8: Square		16: Exp Saw Up
9: Random1(S/H)		17: Exp Saw Down

Amplitude and the duration at which each level is held will both change randomly (sample & hold).

1-4 Key Sync SW [OFF, byTIMBRE, byVOICE]

Specify how key sync (initializing the phase of the LFO waveform by key-on) will occur.

OFF: The LFO will operate (cycle) regardless of key-on.

byTIMBRE: Key sync will occur for the LFOs of all voices at the time of the first key-on that occurs in a state when no keys are on.

byVOICE: Key sync will occur independently for the individual LFO of the voice for which key-on occurred.

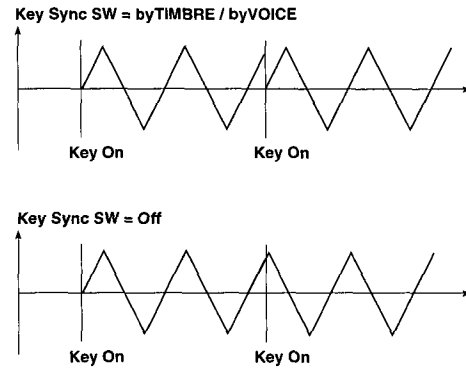

2-2 Frequency [0 (0 Hz)...199 (60 Hz)]
Specify the frequency of the LFO.

2-4 Frequency Mod.1 Source (Mod.Source List 1)
Select a modulation source (see p.104) that will control the LFO frequency.

2-5 Frequency Mod.1 Intensity [-99...+99]
Specify the depth and direction of the effect that "Frequency Mod.1 Source" will have on the "Frequency" value.

3-4 Frequency Mod.2 Source (Mod.Source List 1)

3-5 Frequency Mod.2 Intensity [-99...+99]
Refer to "Frequency Mod.1 Source" and "Frequency Mod.1 Intensity."

4-5 Fade In [0...99]
Specify the time over which the amplitude of the LFO will increase from 0 until it reaches the maximum value.

4-2 Amplitude Mod.Source (Mod.Source List 1)
Select a modulation source (see p.104) that will control the amplitude of the LFO waveform.

4-3 Amplitude Mod.Intensity [-99...+99]
Specify the depth and direction of the effect that "Amplitude Mod.1 Source" will have on the amplitude of the LFO waveform.

4-4 Offset [-50...+50]
Specify the center value of the LFO waveform.

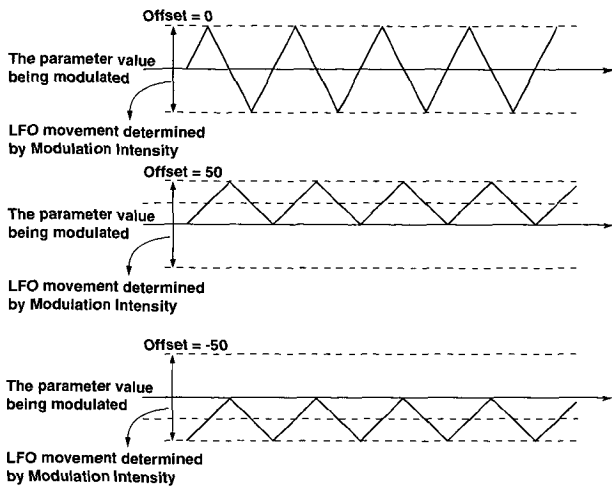

5-3 MIDI Sync [OFF, ON]

When this is ON, the frequency of the LFO will synchronize to MIDI Clock messages. In this case, "LFO Frequency," "Frequency Mod.1 Source," "Frequency Mod.2 Source," "Frequency Mod.1 Intensity," and "Frequency Mod.2 Intensity" settings will have no effect.

If the MIDI mode setting "Clock Source" is INT, the LFO will synchronize to the speed that is specified by the [SPEED] knob on the Z1's front panel. If the "Clock Source" setting is EXT, the LFO will synchronize to MIDI Clock messages that are received from an external MIDI device.

5-4 MIDI Sync Base [♩, ♪, ♫, ♮, ♯, ♭, ♮]

5-5 MIDI Sync Time [1...16]

Relative to the tempo determined by the MIDI clock, these settings specify the note length (Base) and its multiple (Time) that will set the period of the synchronized LFO. For example if "MIDI Sync Base" is ♩ (quarter note) and "MIDI Sync Time" is 4, the LFO period will be four beats.

LFO 2/LFO 3/LFO 4 pages

LFO 2, LFO 3, and LFO 4 have the same parameter as LFO 1. Refer to "LFO 1 page"

7. Prog Fx section

Effect Set Up page

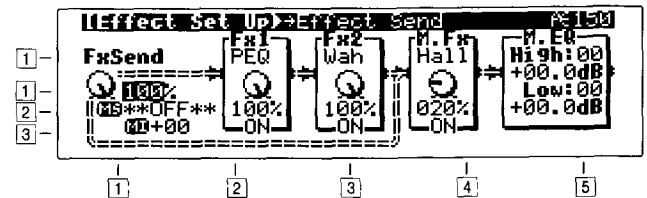

Specify the output level to the effects

1-1 Effect Send [0...100%]

Specify the output level to effects 1 and 2. As this value is increased, a greater proportion of the signal will be output to effects 1 and 2.

2-1 Effect Send Mod.Source (Mod.Source List 1)

Select a modulation source that will control "Effect Send."

3-1 Effect Send Mod.Intensity [-99...+99]

Specify the depth and direction of the control that "Effect Send Mod.Source" will have on the depth of the effect.

Select the effect type for Fx1

1-2 Fx1 Select [OD...RSpl]

Select the type for effect 1. For an explanation of each type, refer to "Effect types" (p.64).

OverDrive, Compressor, ParaEQ, Wah, Exciter, Decimater, Chorus, Flanger, Phaser, RotarySp(S), Delay(Mono), TalkingMod., M.TapDelay, Ensemble, RotarySp(L)

2-2 Fx1 Balance [0...100%]

Specify the balance between the effect sound (Wet) and the direct sound (Dry). This is the same parameter as the Fx1 page "Effect Balance."

3-2 Fx1 SW [OFF, ON]

This turns effect 1 on/off. This provides a way of temporarily auditioning the effect sound and direct sound, or of checking the on/off status when you are using an assignable switch to control the effects.

This setting cannot be saved.

Select the effect type for Fx2

1-3 Fx2 Select[OD...dly]
 Select the type for effect 2. For an explanation of each type, refer to "Effect types".

OverDrive, Compressor, ParaEQ, Wah, Exciter, Decimater, Chorus, Flanger, Phaser, RotarySp(S), Delay(Mono)

 If TalkingMod, M.TapDelay, Ensemble or RotarySp(L) is selected for effect 1, these types cannot be used by effect 2.

2-3 Fx2 Balance[0...100%]

3-3 Fx2 SW [OFF, ON]

Refer to "Fx1 Balance" "Fx1 SW".

Select the effect type for M.Fx

1-4 Master Fx Select [Dly...Room]
 Select the master effect type. For each type, refer to the explanations that are given later.

StereoDelay, Reverb(Hall), Reverb(Room)

If the Global mode GLB Ctrl SetUp page parameter "Master Effect Bypass" is set to BYPASS, a symbol will be displayed, and the master effect will be bypassed.

2-4 MasterFx Balance[0...100%]

3-4 MasterFx SW [OFF, ON]

Refer to "Fx1 Balance Fx1 SW".

Adjusting the gain of the M.EQ

Make settings for the two-band EQ that is applied to the output signal.

1-5 High EQ Frequency [0 (1.00 kHz)...49 (29.9 kHz)]
 Specify the cutoff frequency of the high EQ.

2-5 High EQ Gain [-18.0...+18.0 dB]
 Specify the gain of the high EQ.

3-5 Low EQ Frequency [0 (20.0 Hz)...49 (1.4 kHz)]
 Specify the cutoff frequency of the low EQ.

4-5 Low EQ Gain [-18.0...+18.0 dB]
 Specify the gain of the low EQ.

.....
8. Prog Common section

In the Prog Common section you can make settings for the keyboard and controllers (knobs [1] to [5], the [X-Y PAD] etc.) and assign a name to the program, etc.

.....
CMN Voice page

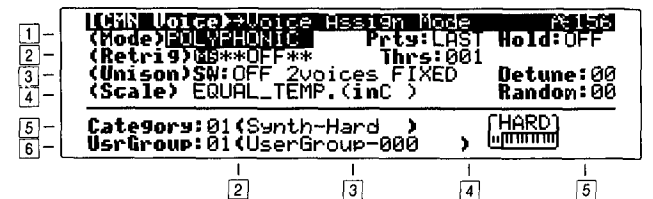

Specifying how the notes played will be sounded

1-2 Voice Assign Mode [MONO_MULTI, MONO_SINGLE, POLYPHONIC]

Specify whether the program will be played monophonically or polyphonically.

- MONO_MULTI : Multi-triggered monophonic
- MONO_SINGLE : Single-triggered monophonic
- POLYPHONIC : The program can be played polyphonically

Refer to "Retrigger Controller" and "Retrigger Control Threshold."

1-4 Key Priority [LAST, LOW, HIGH]

Specify the priority order which determines how notes will sound when more keys are played than can be sounded.

- LAST : The last-played notes will be given priority
- LOW : The lowest notes will be given priority
- HIGH : The highest notes will be given priority

1-5 Hold [OFF, ON]

With a setting of ON, the notes will continue to sound even after the keys are released. However if the AMP section "Amplitude Mod. EG" is being controlled by an EG whose Sustain Level is 0, the sound will decay naturally.

2-2 Retrigger Controller (Mod.Source List 2)

2-4 Retrigger Control Threshold [1...127]

Specify how the EG and LFO will operate when key-on occurs.

The action of resetting the EG and LFO (so that the EG returns to its Start Level, and the LFO returns to the beginning of its waveform) is called "retriggering." On the Z1, you can use the state of the controller specified by "Retrigger Controller" (i.e., whether the controller is above or below the specified threshold) to specify whether or not retriggering will occur when key-on occurs.

The setting of this function changes the way in which "Voice Assign Mode" will work.

MONO_MULTI:

Retriggering will occur below the threshold. If "Retrigger Controller" is OFF, retriggering will always occur.

MONO_SINGLE:

Retriggering will occur above the threshold. If "Retrigger Controller" is OFF, retriggering will not occur.

POLYPHONIC:

Retriggering will occur above the threshold. Below the threshold retriggering will not occur and notes will be sounded monophonically. If "Retrigger Controller" is OFF, retriggering will always occur.

 If key-on occurs from a state of all keys being off, retriggering will always occur. LFOs whose "Key Sync" is OFF will not be reset even if they are retriggered.

3-2 Unison SW [OFF, ON]

This turns unison on/off. By setting either "SW1 Function," "SW2 Function" or "Assignable SW Function" to UNISON, you can control this from the various Play modes (refer to p.62).

3-3 Unison Type [OFF, 2, 3, 6 voices]

Specify the number of notes for unison playing. With a setting of OFF, notes will sound singly.

3-4 Unison Assign Mode [FIXED, DYNAMIC]

Specify how the number of notes specified by "Unison Type" will be maintained.

With a setting of FIXED, the number of notes specified for "Unison Type" will always be sounded. With a setting of DYNAMIC, the number of notes that sound will be determined by the currently-sounding state.

3-5 Unison Detune [0...99]

Detune the notes that are sounded simultaneously by the Unison function.

Select the scale type

4-2 Scale Type [EQUAL_TEMP ... USER_SCALE2]

Specify the scale type for each program.

EQUAL_TEMP (equal temperament): The most widely-used tuning, in which each semitone is spaced at the same pitch interval.

PURE_MAJOR (pure major temperament): Major chords for the principle triads of the specified "Scale Key" will be completely in tune.

PURE_MINOR (pure minor temperament): Minor chords for the principle triads of the specified "Scale Key" will be completely in tune.

ARABIC (Arabic temperament): This is a quarter-tone scale used in Arabic music. Set "Scale Key" to C for rast do/bayati re, to D for rast re/bayati mi, to F for rast fa/bayati sol, to G for rast sol/bayati la, or to A# for rast si flat/bayati do.

PYTHAGOREAN: A scale based on ancient Greek musical theory, particularly effective for melodies.

WERCKMEISTER: An equal temperament used in the later Baroque period.

KIRNBERGER: A harpsichord scale created in the 18th century.

SLENDRO: A gamelan scale of Indonesia in which an octave consists of five notes. Use the C, D, F, G, and A keys (when the Scale Key is C).

PELOG: A gamelan scale of Indonesia in which an octave consists of seven notes. Use the C, D, E, F, G, A and B keys (when the Scale Key is C).

USER_SCALE1 :

USER_SCALE2 :

Settings for USER_SCALE 1 and 2 are made in the Global mode UserScale page.

4-3 Scale Key [C...B]

Specify the key (tonic) on which the specified "Scale Type" will be based.

4-5 Random Pitch Intensity [0...99]

Specify the depth at which the pitch will be varied randomly. Higher settings of this value will cause a correspondingly greater random deviation to be applied to the pitch when each note is sounded. Normally you will leave this parameter set at 0. It provides a way to simulate instruments whose pitch has a natural instability, such as analog synthesizers and acoustic instruments.

Specify the category and user group

5-2 Program Category [1...18]

Specify the category for each program. Normally you will use this to indicate the type of sound.

An icon is shown at the right of the program name in the Program Play mode display, and you can search for and select other programs of the same category by pressing the CATEGORY [▼] and [▲] keys.

- | | |
|-------------------|-------------------|
| 01 (Synth-Hard) | 10 (Strings) |
| 02 (Synth-Soft) | 11 (Choir) |
| 03 (Synth-Lead) | 12 (Brass) |
| 04 (Synth-Motion) | 13 (Reed/Wind) |
| 05 (Synth-Bass) | 14 (Guitar/Pluck) |
| 06 (E.Piano) | 15 (Bass) |
| 07 (Organ) | 16 (Percussion) |
| 08 (Keyboard) | 17 (Arpeggio) |
| 09 (Bell) | 18 (SE/Other) |

6-2 User Group [1...16]

Specify the user group for each program. This provides a convenient way to classify programs by category or music-type.

In the Program Play mode display, the user group is shown at the lower left of the program name, and you can use the USER GROUP [◀||▶] keys to find and select programs in the same user group.

The names of each group number can be registered in the Global mode UserGroupName page.

CMN SW & Pedal page

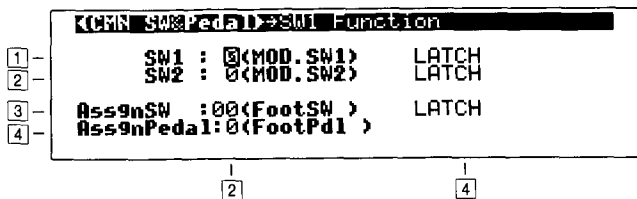

□ Specifying the function of [SW1] and [SW2]

1-2 SW1 Function [0...7]

Specify the function of the [SW1] switch located in the left side of the front panel.

- 0 (MOD.SW1): Function as controller Mod. SW1
- 1 (M.Fx_SW): Turn the master effect on/off
- 2 (Fx1_SW): Turn effect 1 on/off.
- 3 (Fx2_SW): Turn effect 2 on/off.
- 4 (Oct_Up): Raise the note numbers assigned to the keyboard by one octave.
- 5 (OctDown): Lower the note numbers assigned to the keyboard by one octave.
- 6 (MONO_SW): When the "Voice Assign Mode" is POLYPHONIC, switch to monophonic play (same as MONO SINGLE).
- 7 (UNISON): Turn "Union SW" on/off.

In the case of settings 1, 2 or 3, the effect will automatically be ON immediately after the setting is made or immediately after a program change. In the case of 4 or 5, Octave Up/Down will be OFF immediately after the setting is made or immediately after a program change. In the case of 7, the ON/OFF status will be saved to the program (MultiSet) when it is written.

1-4 SW1 Mode [LATCH, UNLAT]

LATCH: The function will be switched on/off each time the switch is pressed.

UNLAT: The function will be on only while you continue pressing the switch.

2-2 SW2 Function [0...7]

The same as for "SW1 Function."

However, 0 (Mod.SW2) will function as controller Mod.SW2.

2-4 SW2 Mode [LATCH, UNLAT]

The same as for "SW1 Mode."

□ Specify the function of each pedal

3-2 Assignable SW Function [0...12]

Specify the function of an pedal (sold separately) connected to the rear panel Assignable SW jack.

- 0 (FootSW): Function as a FootSW controller.
- 1 (Damper): Function as a damper pedal.
- 2 (PrtmSW): Function as a portamento switch.
- 3 (Sostnut): Function as a sostenuto pedal.
- 4 (M.Fx_SW): Turn the master effect on/off.
- 5 (Fx1_SW): Turn effect 1 on/off.
- 6 (Fx2_SW): Turn effect 2 on/off.
- 7 (Oct_Up): Raise the note numbers assigned to the keyboard by one octave.
- 8 (OctDown): Lower the note numbers assigned to the keyboard by one octave.
- 9 (MONO_SW): When the "Voice Assign Mode" is POLYPHONIC, switch to monophonic play (same as MONO SINGLE).
- 10 (UNISON): Turn the unison function on/off.
- 11 (Arpeg SW): Turn the arpeggiator on/off.
- 12 (Pad Hold): Turn the X-Y HOLD function on/off.

In the case of 2, 10 and 12, the ON/OFF status will be saved to the program (MultiSet) when it is written.

3-4 Assignable SW Mode [LATCH, UNLAT]

The same as "SW1 Mode."

However, if "Assignable SW Function" is set to 11 (Arpeg SW) or 12 (Pad Hold), this cannot be set. (The switch will automatically be in LATCH mode.)

4-2 Assignable Pedal Function [0...5]

Specify the function of a pedal (sold separately) connected to the rear panel Assignable Pedal jack.

- 0 (FootPdl): Function as a Foot Pedal controller.
- 1 (MIDI_BC): Function as a MIDI_BC controller.
- 2 (MIDI_PrT): Function as a MIDI_PrT controller.
- 3 (MIDI_Vol): Function as a MIDI_Vol controller.
- 4 (MIDI_Pan): Function as a MIDI_Pan controller.
- 5 (MIDI_Exp): Function as a MIDI_Exp controller.

CMN Mod. Src List page



□ View and edit all modulation sources simultaneously

Here you can view and edit a list of all modulation sources that are used in a program. In particular, this provides a convenient way to check and assign the assigned sources when you wish to control a specific parameter using a controller.

- ① Rotate or press knob [1], or use the CURSOR [▼] or

[▲] keys to select the modulation source parameter. Alternatively, you can double-click knob [5] to make a selection.

② Use knob [5] or the [+] or [-] keys to select the source.

⚠ It is not possible to make parameter settings for an oscillator type or effect type which is not being used.

After making changes, you can sort the list or make global changes or exchanges as follows:

- ① Press the [UTY] key to access the UTILITY menu.
- ② Press knob [3] (Refrsh) to sort the list by the setting values.
- ③ You can use knob [4] (Change) and knob [5] (Exchng) to perform global conversions or replacements of setting values.

CMN PE Define page

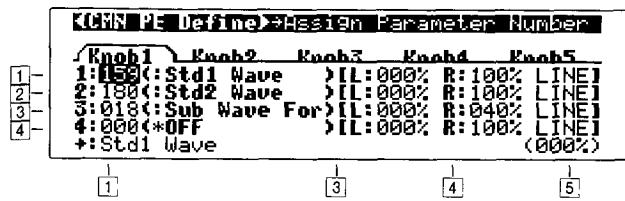

Specify the operation of the Performance Editor

Here you can specify the operation of the Performance Editor (PE) that allows you to modify the sound in Play mode by operating knobs [1] to [5]. Up to 4 parameters can be assigned to each knob.

- ① Either press the [◀] or [▶] key, or press the [TAB] key (the LED will light) to access the tab menu in the lower part of the LCD, and then select the knob that will control the parameters.
- ② Press the [▼] or [▲] key to select a set (1 to 4).
- ③ Set the following parameters, either by pressing or by rotating the appropriate knob.

***-1 Assign Parameter Number [0...230]**

Select the PE number of the parameter that you wish to control using the knob (see p.107). The parameter name will appear in the bottom line of the display. The numerical value at the lower right of the display shows the proportion of the current value of the selected parameter in relation to the variable range of the parameter.

***-3 Knob Left Ratio [0...100%]**

Specify the edit value that will be in effect when the knob is rotated fully left, as a proportion to the variable range of the parameter. For example if the parameter selected by "Assign Parameter Number" has

a range of -99 to +99 and if the setting here is 50%, rotating the knob fully left will produce a parameter value of 0. If this setting is 0%, the parameter value will be -99. When the cursor is located at this parameter, the result of the setting value will be temporarily reflected in the sound.

***-4 Knob Right Ratio [0...100%]**

Specify the edit value that will be in effect when the knob is rotated fully right, as a proportion to the variable range of the parameter. For details, refer to the explanation above. When the cursor is located at this parameter, the result of the setting value will be temporarily reflected in the sound.

***-5 Curve [LINE, EXPO, LOG, SW]**

Select one of four curves to specify how the sound will change when the knob is rotated.

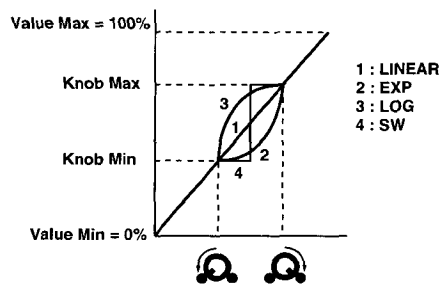

⚠ If the same parameter is assigned more than once to a single knob, the lowest-numbered set number will take priority.

In addition to the settings here, you can also use a Utility function to make settings (see p.20 and 106).

CMN Program Name page view

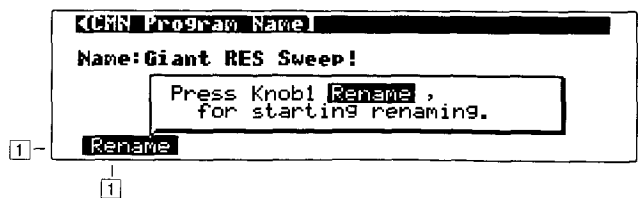

Modifying the name of a program

1-1 Name Edit

Specify the name of the program. For the procedure, refer to "Modifying a name (Rename)" (p.25).

Program Edit

CMN

Effect types

Fx1 page

☐ Specify the effect which Fx1 will use

Overdrive

This is a distortion with two modes: overdrive and high gain. By controlling the four-band equalizer you can create a variety of distortion sounds.

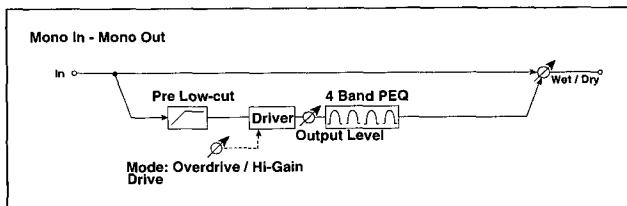

```

1  <F1( ON) > Mode
2  <OverDrive> Mode:00 LoCut:50 Drive:50
3  <Output>Lv1:20
4  <High> Fc:43=13.7[kHz] Q:05.0 G-13.0
5  <MidH> Fc:32=3.20[kHz] Q:02.0 G+15.0
6  <MidL> Fc:14=252.0[kHz] Q:03.0 G-02.0
7  <Low> Fc:31=293.4[kHz] Q:01.0 G+12.0
   <Balance> 100% GB**OFF**00+00
  
```

1-3 Mode [OD, DIST]
Select either OD (overdrive) or DIST (distortion).

1-4 Pre Low Cut [0...99]
Specify the amount of low cut that will be applied at the input of the distortion. By cutting the low range before distortion is applied, you can create sharper distortion.

1-5 Drive [0...99]
Specify the degree of distortion. The degree of distortion will be determined by the level of the input signal itself and by the "Drive" setting. Raising "Drive" will increase the overall volume, so use "Output Level" to adjust the volume. "Output Level" is also the input level to the 4-band EQ. If the 4-band EQ clips, adjust the "Output Level."

2-2 Output Level [0...99]
Specify the output level. Refer to "Drive."

3-2 High EQ Cutoff [00 (500.0 Hz)...49 (21.8 kHz)]
Specify the center frequency of the high EQ.

3-4 Q [00.5 ... 10.0]
Specify the bandwidth of the high EQ filter. Increasing this value will make the band narrower and sharper.

3-5 Gain [-18.0...+18.0 dB]
Specify the gain of the high EQ.

4-2 MidH EQ Cutoff [00 (200.0 Hz)...49 (14.0 kHz)]
Specify the center frequency of the mid-high EQ.

4-4 Q [00.5 ... 10.0]
Specify the bandwidth of the mid-high EQ filter. Refer to "3-4 Q."

4-5 Gain [-18.0...+18.0 dB]
Specify the gain of the mid-high EQ.

5-2 MidL EQ Cutoff [00 (50 Hz)...49 (14.4 kHz)]
Specify the center frequency of the mid-low EQ.

5-4 Q [00.5 ... 10.0]
Specify the bandwidth of the mid-low EQ filter. Refer to "3-4 Q."

5-5 Gain [-18.0...+18.0 dB]
Specify the gain of the mid-low EQ.

6-2 Low EQ Cutoff [00 (20 Hz)...49 (1.40 kHz)]
Specify the center frequency of the low EQ.

6-4 Q [00.5 ... 10.0]
Specify the bandwidth of the low EQ filter. Refer to "3-4 Q."

6-5 Gain [-18.0...+18.0 dB]
Specify the gain of the low EQ.

7-2 Effect Balance [0...100%]
Specify the balance between the effect sound (Wet) and the direct sound (Dry).

7-3 Balance Mod.Source (Mod.Source List 2)
Select a modulation source (see p.104) that will control "Effect Balance."

7-4 Balance Mod.Intensity [-99...+99]
Specify the depth and direction of the effect of "Balance Mod.Source."

Compressor

This effect compresses the input signal, to smooth out irregularities in volume and give the sound more punch. It is effective on guitar, piano and drums as well.

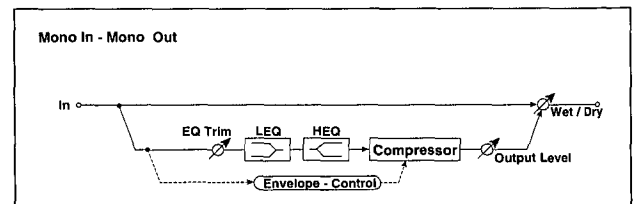

```

1  <F1( ON) > Sensitivity
2  <Compressor>
3  Sens:50 Atk:50
4  <PreEQ>Trin:99 LoG+00.0 HiG+00.0
   <Output>Lv1:35
   <Balance> 100% GB**OFF**00+00
  
```

1-1 Sensitivity [01...99]

Specify the sensitivity of the compressor. As this value is increased, lower level sounds will be boosted in volume. Since raising this value will increase the overall volume, you can use the "Output Level" to make a final volume adjustment.

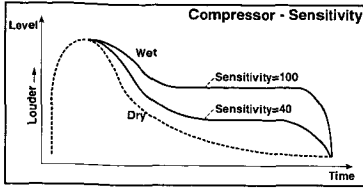

1-2 Attack [01...99]

This parameter controls the strength of the feeling of attack that is unique to a compressor.

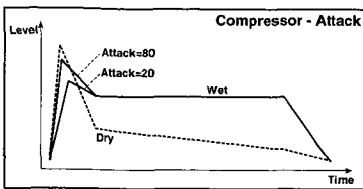

2-2 Pre EQ Input Trim [00...99]

Specify the input level to the equalizer.

2-3 Pre Low EQ Gain [-18.0...+18.0 dB]

Specify the gain of the low range equalizer.

2-4 Pre High EQ Gain [-18.0...+18.0 dB]

Specify the gain of the high range equalizer.

3-2 Output Level [00...99]

Specify the output level of the compressor. Refer to "Sensitivity."

4-2 Effect Balance [0...100%]

Specify the balance between the effect sound and the direct sound.

4-3 Balance Mod.Source (Mod.Source List 2)

Select a modulation source (see p.104) that will control "Effect Balance."

4-4 Balance Mod.Intensity [-99...+99]

Specify the depth and direction of the effect that "Balance Mod.Source" will have.

Parametric EQ

This is a four-band parametric equalizer. For the high EQ and low EQ you can select either peaking or shelving type. For the mid-low EQ, a modulation source can control the gain.

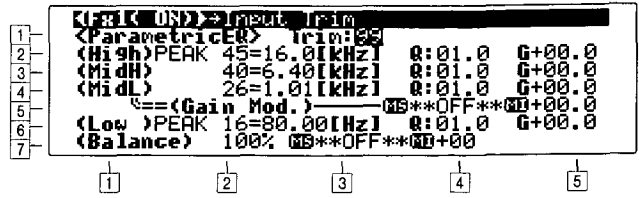
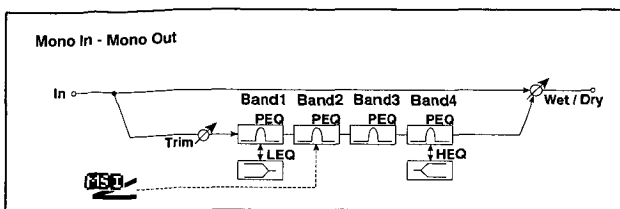

1-3 Input Trim [0...99]

Specify the input level.

2-1 High EQ Type [PEQ (Peaking), SHLV (Shelving-Low)]

Select the filter type for the high EQ.

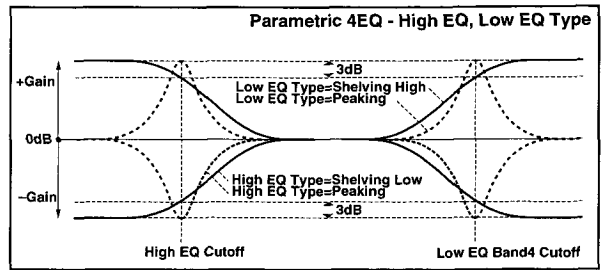

6-1 Low EQ Type [PEQ (Peaking), SHLV (Shelving-Low)]

Select the filter type for the low EQ.

2-2 High EQ Cutoff [00 (500.0 Hz)...49 (21.8 kHz)]

Specify the center frequency of the high EQ.

2-4 High EQ Q [00.5 ... 10.0]

Specify the bandwidth of the high EQ filter. Increasing this value will make the band narrower and sharper.

2-5 High EQ Gain [-18.0...+18.0 dB]

Specify the gain of the high EQ.

3-2 MidH EQ Cutoff [00 (200 Hz)...49 (14.0 kHz)]

Specify the center frequency of the mid-high EQ.

3-4 MidH EQ Q [00.5 ... 10.0]

Specify the bandwidth of the mid-high EQ filter.

3-5 MidH EQ Gain [-18.0...+18.0 dB]

Specify the gain of the mid-high EQ.

4-2 MidL EQ Cutoff [00 (50.00 Hz)...49 (14.4 kHz)]

Specify the center frequency of the mid-low EQ.

4-4 MidL EQ Q [00.5 ... 10.0]

Specify the bandwidth of the mid-low EQ filter.

4-5 MidL EQ Gain [-18.0...+18.0 dB]

Specify the gain of the mid-low EQ.

5-4 MidL EQ Gain Mod.Source (Mod.Source List 2)

Select a modulation source (see p.104) that will control "MidL EQ Gain."

Program Edit
MultiSet Edit

Effect Type

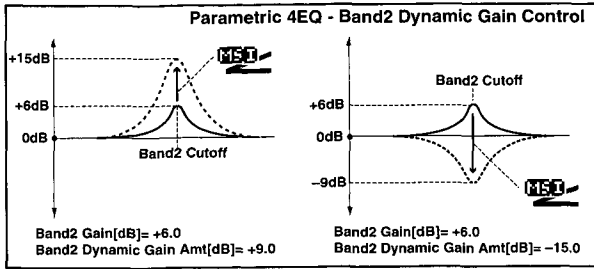

5-5 MidL EQ Gain Mod.Intensity [-18.0...+18.0 dB]

Specify the depth and direction of the effect of "MidL EQ Gain Mod.Source."

6-2 Low EQ Cutoff [00 (20.00 Hz)...49 (1.40 kHz)]

Specify the center frequency of the low EQ.

6-4 Low EQ Q [0.5 ... 10.0]

Specify the bandwidth of the low EQ filter.

6-5 Gain [-18.0...+18.0 dB]

Specify the gain of the low EQ.

7-2 Effect Balance [0... 100%]

Specify the balance between the effect sound (Wet) and the direct sound (Dry).

7-3 Balance Mod.Source (Mod.Source List 2)

Select a modulation source (see p.104) that will control "Effect Balance."

7-4 Balance Mod.Intensity [-99...+99]

Specify the depth and direction of the effect of "Balance Mod.Source."

Wah

This wah effect allows simulation of vintage wah pedals, auto wah units, and an even wider range of settings. Either a band pass filter or a low pass filter can be selected as the wah filter.

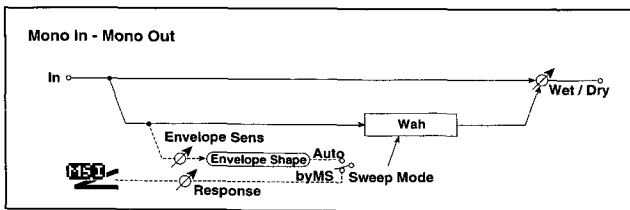

```

1  <F1> <UND> Frequency Bottom 1800
2  <Wah>
3  (Frequency)Btn:05 Top:35
4  (Sweep) Mode:Auto Response:99
5  (Envelope)Sens:99 Shp:00
   (Filter) Type:LPF Reso:70
   (Balance) 100% NS**OFF**ND+00
  
```

1-2 Frequency Bottom [0...99]

Specify the lower limit of the wah center frequency. The sweep width and direction of the wah filter will be determined by the "Frequency Top" and "Frequency Bottom" settings.

1-3 Frequency Top [0...99]

Specify the upper limit of the wah center frequency.

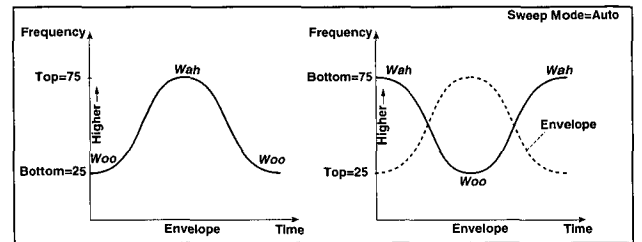
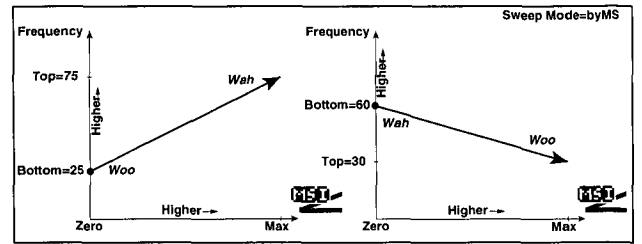

2-2 Sweep Mode [AUTO, byMS]

Select the wah control mode. When AUTO is selected, changes in the level of the input signal (i.e., the envelope of the input signal) will control the sweep, producing an auto-wah effect. This is a popular effect to apply to muted guitar chords or to clavinet-type sounds. When byMS is selected, a modulation source can be used to directly control the filter, as on a wah pedal.

2-3 Sweep Source (Mod.Source List 2)

Select a modulation source (see p.104) that will control the wah filter when "Sweep Mode" is set by the byMS setting.

2-5 Sweep Response [0...99]

Specify the speed of response of the wah to the byMS setting.

3-2 Envelope Sens [0...99]

Specify the sensitivity of the auto-wah. If the input signal is too soft to produce a sufficient sweep, raise this value. If the input signal is too loud, causing the filter operation to halt temporarily, lower this value.

3-3 Envelope Shape [-99...+99]

Specify the sweep curve of the auto-wah.

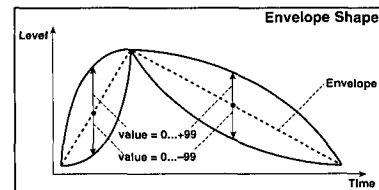

4-2 Filter Type [BPF (Band Pass), LPF (Low Pass)]

Select the type of wah filter.

4-3 Resonance [0...99]

Specify the amount of resonance.

5-2 Effect Balance [0... 100%]

Specify the balance between the effect sound (Wet) and the direct sound (Dry).

come stronger. Since for some settings the volume will also be affected, you can use "Output Level" to make adjustments.

- 4-2 **High Damp [%]**[0...100%]
Specify the amount of the high range that will be cut.
- 5-2 **Output Level** [00...99]
Specify the output level of the decimator.
- 6-2 **Effect Balance**[0...100%]
Specify the balance between the effect sound (Wet) and the direct sound (Dry).
- 6-3 **Balance Mod.Source** (Mod.Source List 2)
Select a modulation source (see p.104) that will control "Effect Balance."
- 6-4 **Balance Mod.Intensity** [-99...+99]
Specify the depth and direction of the effect of "Balance Mod.Source."

Chorus

This effect modulates the delay time of the input signal to add depth and warmth to the sound. A two-band equalizer lets you adjust the tone of the effect sound to your taste.

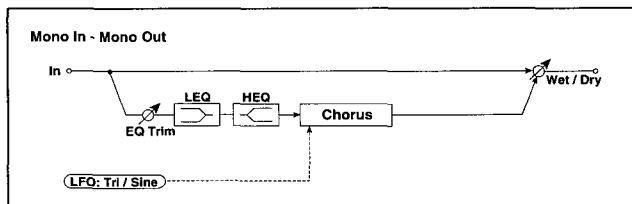

```

1  [F1] [ON] Delay Time
2  <Chorus>
3  (Delay)Time: 20.0 [ms]
4  (LFO)TRI f: 01.00 [Hz] BS**OFF**00+00.00
5  (MIDI Sync) Sync: OFF Base: f Time: x01
6  (Depth)Dpth: 30 BS**OFF**00+00 Phase: +
   (PreEQ)Trin: 99 LoG+00.0 HiG+00.0
   (Balance) 050% BS**OFF**00+00

```

- 1-2 **Delay Time** [0.0...50.0 ms]
Specify the delay time from the original sound.
- 2-1 **LFO Wave Form** [TRI (Triangle), SIN (Sine)]
Select the LFO waveform.
- 2-2 **LFO Frequency** [0.04...20.00 Hz]
Specify the LFO speed.
- 2-4 **LFO Frequency Mod.Source** (Mod.Source List 2)
Select a modulation source (see p.104) that will control "LFO Frequency."
- 2-5 **LFO Frequency Mod.Int.** [-20.00...+20.00 Hz]
Specify the depth and direction of the effect of "LFO Frequency Mod.Source."
- 3-3 **MIDI Sync** [OFF, ON]
- 3-4 **MIDI Sync Base** [, ♪, ♫, ♪, ♫, ♪, ♫, ♪, ♫]

- 3-5 **MIDI Sync Time** [1...16]
For details on "MIDI Sync," "MIDI Sync Base" and "MIDI Sync Time," refer to the LFO section (p.59).
- 4-2 **Depth** [0...99]
Specify the depth of LFO modulation.
- 4-3 **Depth Mod.Source** (Mod.Source List 2)
Select a modulation source (see p.104) that will control "Depth."
- 4-4 **Depth Mod.Int** [-99...+99]
Specify the depth and direction of the effect of "Depth Mod.Source."
- 4-5 **Output Phase** [+ , - , +/- for wider stereo imaging]
Set the phase of the effect sound (Wet).

If only the L/MONO OUTPUT jack is connected, a setting of +/- will cause the effect sound to disappear. In this case, set the Global mode "Output Mode" parameter to MONO.

- 5-2 **Pre EQ Input Trim** [0...99]
Specify the input level to the equalizer.
- 5-3 **Pre Low EQ Gain [dB]** [-18.0...+18.0 dB]
Specify the gain of the low-range equalizer.
- 5-4 **Pre High EQ Gain [dB]** [-18.0...+18.0 dB]
Specify the gain of the high-range equalizer.
- 6-2 **Effect Balance** [0...100%]
Specify the balance between the effect sound (Wet) and the direct sound (Dry).
- 6-3 **Balance Mod.Source** (Mod.Source List 2)
Select a modulation source (see p.104) that will control "Effect Balance."
- 6-4 **Balance Mod.Intensity** [-99...+99]
Specify the depth and direction of the effect of "Balance Mod.Source."

Flanger

This creates a strong "swishing" effect and a sense of cycling pitch. It is effective when applied to sounds that contain plenty of overtones, such as lead sounds.

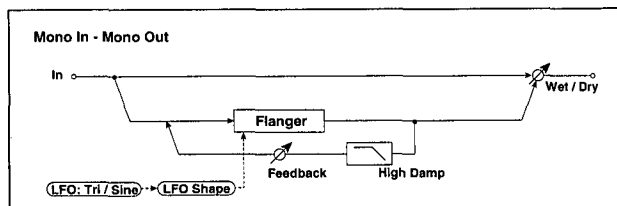

```

1  [F1] [ON] Delay Time
2  <Flanger>
3  (Delay)Time: 00.0 [ms]
4  (LFO)Wave: TRI Shp-50
   f: 00.20 [Hz] BS**OFF**00+00.00
5  (MIDI Sync) Sync: OFF Base: f Time: x01
6  (Depth)Dpth: 50 Fbk+50 H.D: 00 Phase: +
   (Balance) 050% BS**OFF**00+00

```

1-2 Delay Time [0.0...50.0 mS]

Specify the delay time from the original sound.

2-2 LFO Wave Form [TRI (Triangle), SIN (Sine)]

Select the LFO waveform.

2-3 LFO Shape [-99...+99]

Specify the degree to which the LFO waveform will be modified. By modifying the LFO waveform you can control the sense of sweep that occurs at the flanging peaks.

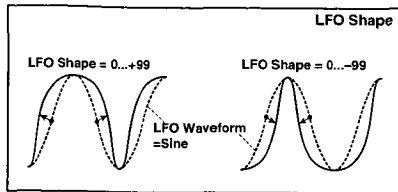

3-2 LFO Frequency [0.04...20.00 Hz]

Specify the LFO speed.

3-4 LFO Frequency Mod.Source (Mod.Source List 2)

Select a modulation source (see p.104) that will control "LFO Frequency."

3-5 LFO Frequency Mod.Int. [-20.00...+20.00 Hz]

Specify the depth and direction of the effect of "LFO Frequency Mod.Source."

4-3 MIDI Sync [OFF, ON]

4-4 MIDI Sync Base [MIDI Note Symbols]

4-5 MIDI Sync Time [1...16]

For details on "MIDI Sync," "MIDI Sync Base" and "MIDI Sync Time," refer to the LFO section (p.59).

5-2 Depth [00...99]

Specify the depth of LFO modulation.

5-3 Feedback [-99...+99]

Specify the amount of feedback. Positive (+) values and negative (-) values will affect the peaks in different ways. If this parameter is set to a positive (+) value and "Output Phase" is also set to a positive value, or if this parameter is set to a negative (-) value and "Output Phase" is also set to a negative value, the overtones will be emphasized when the flanged sound is mixed with the direct sound.

5-4 High Damp [%] [0...99%]

Specify the amount of the high range that will be cut from the feedback. As this value is increased, more of the high-range overtones will be suppressed.

5-5 Output Phase [+ , - , +/- for wider stereo imaging]

Invert the phase of the effect sound (Wet). Refer to the "Feedback."

If only the L/MONO OUTPUT jack is connected, a setting of +/- will cause the effect sound to disappear. In this case, set the Global mode "Output Mode" parameter to MONO.

6-2 Effect Balance [0...100%]

Specify the balance between the effect sound (Wet) and the direct sound (Dry).

6-3 Balance Mod.Source (Mod.Source List 2)

Select a modulation source (see p.104) that will control "Effect Balance."

6-4 Balance Mod.Intensity [-99...+99]

Specify the depth and direction of the effect of "Balance Mod.Source."

Phaser

This effect modulates the phase of the sound to create a twisting sensation. It is effective when applied to an electric piano etc.

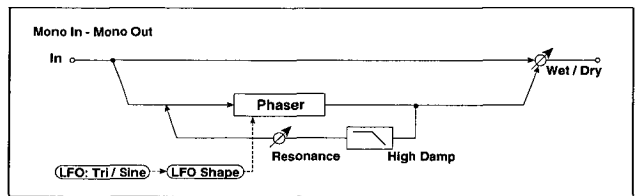

```

[1] (F) (K) (ON) LFO Wave Form
[2] <Phaser>
[3] (LFO) Wave: SIN Shp+00
[4] f: 00.68 [Hz] BS**OFF**00+00.00
[5] (MIDI Sync) Sync: OFF Base: F Time x01
[6] (Manual) 90
[2] (Depth) Dpth: 30 Reso: 30 H.D: 00 Phase: -
[3] (Balance) 050% BS**OFF**00+00

```

1-2 LFO Waveform [TRI (Triangle), SIN (Sine)]

Select the LFO waveform.

1-3 LFO Shape [-99...+99]

Specify the degree to which the LFO waveform will be modified. Refer to Flanger 3-2 "LFO Frequency."

2-2 LFO Frequency [00.04...20.00 Hz]

Specify the LFO speed.

2-4 LFO Frequency Mod.Source (Mod.Source List 2)

Select a modulation source (see p.104) that will control "LFO Frequency."

2-5 LFO Frequency Mod.Int. [-20.00...+20.00 Hz]

Specify the depth and direction of the effect of "LFO Frequency Mod.Source."

3-2 Manual [0...99]

Specify the frequency at which the effect will be applied.

5-2 Depth [0...99]

Specify the depth of LFO modulation.

5-3 Resonance [-99...+99]

Specify the amount of resonance. The effect on the peaks will be different for positive (+) settings and negative (-) settings. If both this parameter and "Effect Balance (Wet/Dry)" are set to positive values, or both

set to negative values, the overtones will be emphasized when the direct sound and effect sound are mixed.

5-4 High Damp [%] [0...99%]
Specify the amount of the high range that will be cut from the resonance. As this value is increased, more of the high-range overtones will be suppressed.

5-5 Output Phase [+ , - , +/- for wider stereo imaging]
Invert the phase of the effect sound (Wet).

 If only the L/MONO OUTPUT jack is connected, a setting of +/- will cause the effect sound to disappear. In this case, set the Global mode "Output Mode" parameter to **MONO**.

6-2 Effect Balance [0... 100%]
Specify the balance between the effect sound (Wet) and the direct sound (Dry).

6-3 Balance Mod.Source (Mod.Source List 2)
Select a modulation source (see p.104) that will control "Effect Balance."

6-4 Balance Mod.Intensity [-99...+99]
Specify the depth and direction of the effect of "Balance Mod.Source."

Rotary Speaker (Small)

This effect simulates the rotary speaker that is indispensable to electric organ sounds. This simulates the sound that is produced when the drive belt for the low-frequency rotor is removed to fix it in place. You can use a modulation source to switch the rotational speed of the speaker. Microphone placement is also simulated.

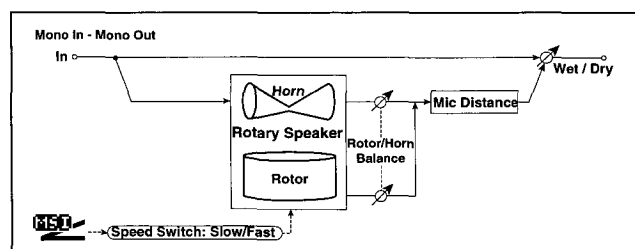

```

1- [F1] ( ON ) Speed SW R:189
   <RotarySpeaker(Small)>
2- (Speed) SLOW SW:**OFF**
3- (Horn)Accel:50 Rate:50
   (Mic) Dstn:50 (H/R)50
4- (Balance) 100% MS:**OFF**00+00
  
```

1-2 Speed Switch [SLOW, FAST]
Switch the rotation speed (slow/fast) of the speaker.

1-3 Speed Switching Source (Mod.Source List 2)
Select a modulation source (see p.104) that will control the "Speed Switch." When "Speed Switch" is **SLOW**, the rotation will normally be **SLOW**, and will accelerate to **FAST** only when you operate the modulation source (by pressing the pedal, etc.). The speed will switch to **FAST** when the value of the modula-

tion source rises to 64 or higher. For values of 63 or lower, the speed will be **SLOW**.

2-2 Horn Acceleration [00...99]
Specify the rapidity with which the rotational speed of the high frequency horn will change. On an actual rotary speaker, the speed does not switch immediately between fast/slow, but accelerates or decelerates over an interval of time.

2-3 Horn Ratio [00...99]
Adjust the rotational speed of the high frequency horn. 50 is normal, and 0 is stopped.

3-2 Mic Distance [00...99]
This simulates the distance at which the mic is placed. Specify the separation between the microphone and the rotary speaker.

3-3 Horn/Rotor Balance [0...99]
Specify the volume balance between the low frequency rotor and the high frequency horn. Raising this value will increase the volume of the high frequency horn.

4-2 Effect Balance [0... 100%]
Specify the balance between the effect sound (Wet) and the direct sound (Dry).

4-3 Balance Mod.Source (Mod.Source List 2)
Select a modulation source (see p.104) that will control "Effect Balance."

4-4 Balance Mod.Intensity [-99...+99]
Specify the depth and direction of the effect of "Balance Mod.Source."

Delay (Mono)

This effect delays the input signal. Since the feedback attenuation of the low-frequency and high-frequency ranges can be set independently, you can vary the delay sound substantially.

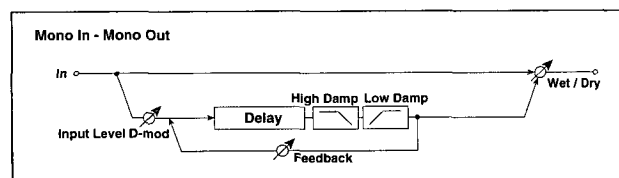

```

1- [F1] ( ON ) InputLevel Mod.Src
   <Delay(Mono)>
2- (InputLevelMod.) MS:**OFF**00+00
3- (Time) 300[ms]
4- (Feedback) +15 MS:**OFF**00+00
   (Damp) Low:00 High:00
5- (Balance) 050% MS:**OFF**00+00
  
```

1-3 Input Level Mod.Source (Mod.Source List 2)
Select a modulation source (see p.104) that will control the input level.

1-4 Input Level Mod.Intensity [-99...+99]
Specify the depth and direction of the effect of "Input Level Mod.Source."

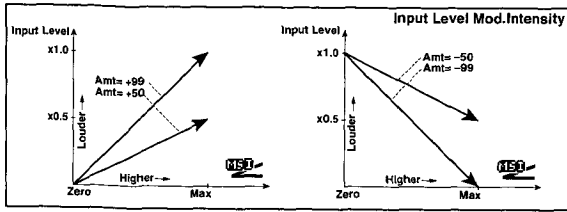

- 2-2 Delay Time** [0...680 mS]
Specify the delay time.
- 3-2 Feedback** [-99...+99]
Specify the amount of feedback.
- 3-3 Feedback Mod.Source** (Mod.Source List 2)
Select a modulation source (see p.104) that will control "Feedback."
- 3-4 Feedback Mod.Intensity** [-99...+99]
Specify the depth and direction of the effect of "Feedback Mod.Source."
- 4-2 Low Damp** [0...99%]
Specify the attenuation of the low frequency range. This will cause the delay sound to become successively lighter in tone each time it is fed back.
- 4-3 High Damp** [0...99%]
Specify the attenuation of the high frequency range. This will cause the delay sound to become successively darker in tone each time it is fed back.
- 5-2 Effect Balance** [0...100%]
Specify the balance between the effect sound (Wet) and the direct sound (Dry).
- 5-3 Balance Mod.Source** (Mod.Source List 2)
Select a modulation source (see p.104) that will control "Effect Balance."
- 5-4 Balance Mod.Intensity** [-99...+99]
Specify the depth and direction of the effect of "Balance Mod.Source."

Talking Modulator

This effect gives the input signal a resemblance to a human voice. A modulation source can be used to vary the tone, creating a sound as though a guitar or synthesizer is speaking.

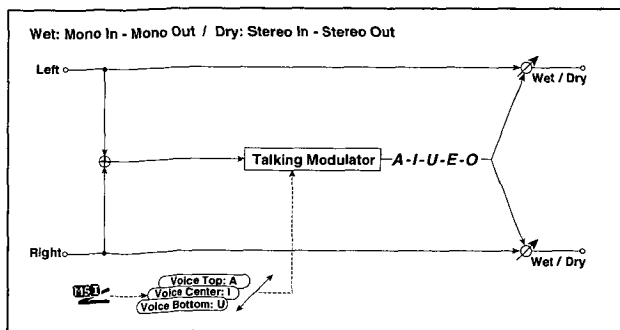

```

1  [1] (ON) Control Mode
2  <TalkingModulator>
3  (Control) MANUAL(BOTTOM)
4  (Voice) Bottom:U Center:A Top:I
5  (Formant Shift) +00
   (Resonance) 50
   (Balance) 100% MS**OFF**00+00
   
```

- 1-2 Control Mode** [MANUAL, byMS]
Specify how the voice pattern will be controlled. With MANUAL, the value of "Manual Control" will determine the voice pattern. With byMS, the value of the controller selected for "Control Source" will determine the voice pattern.
- 1-3 Manual Control** [BOTTOM...CENTER...TOP]
This parameter will appear when "Control Mode" is set to MANUAL. Use this when you wish to fix the voice pattern without using a controller (for example if you want the sound to be fixed between "aah" and "iih").
- 1-3 Control Source** (Mod.Source List 2)
This parameter will appear when "Control Mode" is set to byMS. Select a modulation source that will control the voice pattern.
- 2-2 Voice Bottom** [A, I, U, E, O]
- 2-3 Voice Center** [A, I, U, E, O]
- 2-4 Voice Top** [A, I, U, E, O]
Assign vowels to the bottom, center and top ranges of the controller. For example if X[+/-] is selected as the modulation source and you set "Voice Top" to A, "Voice Center" to I and "Voice Bottom" to U, sliding your finger from the right edge to the left edge of the [X-Y PAD] will cause the voice to change from "aah" to "iih" to "uuh."
- 3-3 Formant Shift** [-99...+99]
Adjust the frequency at which the effect will apply. Specify higher values if you want the effect to apply to higher sounds, or lower values if you want it to apply to lower sounds.
- 4-3 Resonance** [0...99]
Specify the strength of resonance for the voice pattern. Increasing this value will produce a more distinctive sound.
- 5-2 Effect Balance** [0...100%]
Specify the balance between the effect sound (Wet) and the direct sound (Dry).

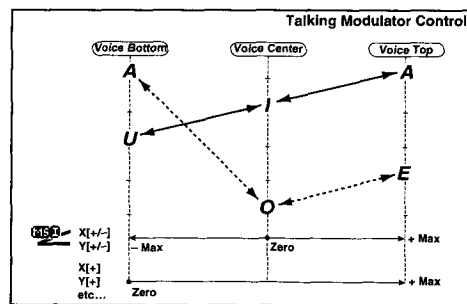

- 3-3 Formant Shift** [-99...+99]
Adjust the frequency at which the effect will apply. Specify higher values if you want the effect to apply to higher sounds, or lower values if you want it to apply to lower sounds.
- 4-3 Resonance** [0...99]
Specify the strength of resonance for the voice pattern. Increasing this value will produce a more distinctive sound.
- 5-2 Effect Balance** [0...100%]
Specify the balance between the effect sound (Wet) and the direct sound (Dry).

5-3 Balance Mod.Source (Mod.Source List 2)
 Select a modulation source (see p.104) that will control "Effect Balance."

5-4 Balance Mod.Intensity [-99...+99]
 Specify the depth and direction of the effect of "Balance Mod.Source."

Multitap Delay

This is a stereo multi-tap delay with two delay taps each for left and right. Since you can specify how the feedback and tap outputs will be connected, a variety of complex spatial patterns can be created.

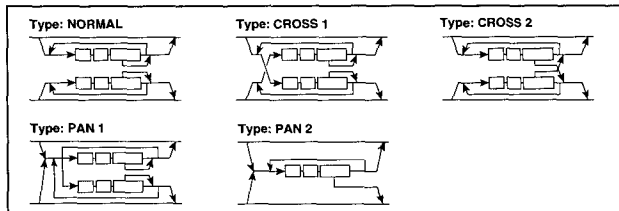
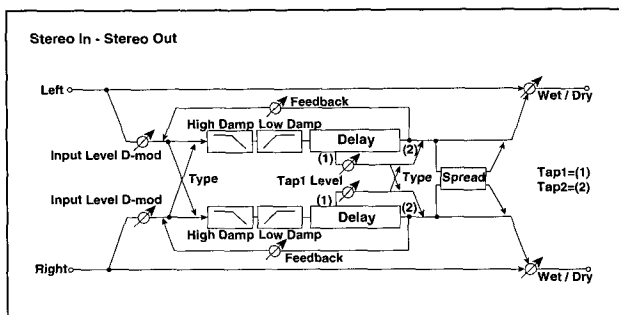

```

1  [MTRK (ON)] → [EFFECT] [MTRK (ON)] [MTRK (ON)]
2  <MultitapDelay> Type: NORMAL
3  (InputLevelMod.) [ON]**OFF**[00]+00
4  (Taps) Tap1: 350[mS] L: 30 Tap2: 500[mS]
5  (Feedback) +20 [ON]**OFF**[00]+00
6  (Damp) Low: 00 Hi 9h: 00
7  (Spread) +99 [ON]**OFF**[00]+00
  (Balance) 050% [ON]**OFF**[00]+00
  
```

1-3 Type [NORMAL, CROSS1, CROSS2, PAN1, PAN2]
 Specify how the left/right delays will be connected. By changing the connections between the left and right delays as shown in the diagram above, you can specify how the delays will be panned left/right.

2-3 Input Level Mod.Source (Mod.Source List 2)
 Select a modulation source (see p.104) that will control the input level.

2-4 Input Level Mod.Int [-99...+99]
 Specify the depth and direction of the effect of "Input Level Mod.Source."

3-2 Tap 1 Time [0...680 mS]
 Specify the delay time of tap 1.

3-3 Tap 1 Level [0...99]
 Specify the output level of tap 1. By creating volume differences relative to tap 2, you can give a sense of "groove" to the delay and feedback that might otherwise become monotonous.

3-5 Tap 2 Time [0...680 mS]
 Specify the delay time of tap 2.

4-2 Feedback [-99...+99]
 Specify the amount of feedback for tap 2.

4-3 Feedback Mod.Source (Mod.Source List 2)
 Select a modulation source (see p.104) that will control "Feedback."

4-4 Feedback Mod.Intensity [-99...+99]
 Specify the depth and direction of the effect that "Feedback Mod.Source" will have.

5-2 Low Damp [0...99]
 Specify the attenuation of the low frequency range. This will cause the delay sound to become successively lighter in tone each time it is fed back.

5-3 High Damp [0...99]
 Specify the attenuation of the high frequency range. This will cause the delay sound to become successively darker in tone each time it is fed back.

6-2 Spread [-99...+99]
 Specify the stereo spread (width) of the effect sound. A setting of +99 will produce the maximum spread, and with a setting of 0 the effect sound of both channels will be output from the center. With negative (-) settings the effect sound will be inverted left/right.

6-3 Spread Mod.Source (Mod.Source List 2)
 Select a modulation source (see p.104) that will control "Spread."

6-4 Spread Mod.Intensity [-99...+99]
 Specify the depth and direction of the effect that "Spread Mod.Source" will have.

7-2 Effect Balance [0...100%]
 Specify the balance between the effect sound (Wet) and the direct sound (Dry).

7-3 Balance Mod.Source (Mod.Source List 2)
 Select a modulation source (see p.104) that will control "Effect Balance."

7-4 Balance Mod.Intensity [-99...+99]
 Specify the depth and direction of the effect of "Balance Mod.Source."

Ensemble

This is an ensemble effect with three chorus blocks. The blocks are output to left, right and center respectively, creating an ensemble effect with spatial depth and breath.

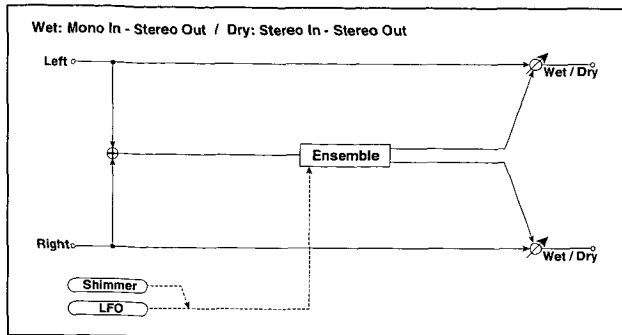

```

1-2 [F1] (UN) Speed 30
<Ensemble>
2- (Speed) Shimmer+50 63**OFF**00+00
3- (Depth) 50 63**OFF**00+00
4- (Balance) 050% 63**OFF**00+00
  
```

1-2 Speed [0...99]
Specify the LFO speed.

1-3 Speed Mod.Source (Mod.Source List 2)
Select a modulation source (see p.104) that will control "Speed."

1-4 Speed Mod.Intensity [-99...+99]
Specify the depth and direction of the effect of "Speed Mod.Source."

2-2 Shimmer [-99...+99]
Specify the amount by which the LFO waveform will be modulated. As this value is raised, the LFO waveform will be modulated more greatly, producing a more complex and richer chorus effect.

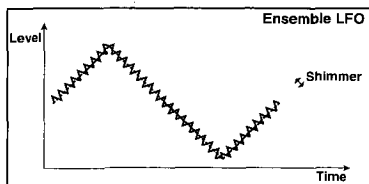

3-2 Depth [0...99]
Specify the depth of LFO modulation.

3-3 Depth Mod.Source (Mod.Source List 2)
Select a modulation source (see p.104) that will control "Depth."

3-4 Balance Mod.Intensity [-99...+99]
Specify the depth and direction of the effect of "Depth Mod.Source."

4-2 Effect Balance [0...100%]
Specify the balance between the effect sound (Wet) and the direct sound (Dry).

4-3 Balance Mod.Source (Mod.Source List 2)
Select a modulation source (see p.104) that will control "Effect Balance."

4-4 Balance Mod.Intensity [-99...+99]
Specify the depth and direction of the effect of "Balance Mod.Source."

Rotary Speaker (Large)

This effect simulates a rotary speaker. Since the low frequency rotor and the high frequency horn are simulated separately, a highly realistic sound is produced. The mic position is also simulated.

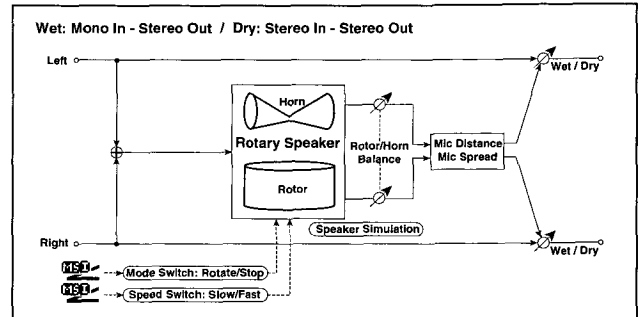

```

1-2 [F1] (UN) Speed 30
<RotarySpeaker(Large)>
2- (Speed) 8000 SW:**OFF**
3- (Mode) ROTATE SW:**OFF**
4- (Roto)Accel:50 Rate:50
5- (Horn)Accel:50 Rate:50
6- (Mic) Dstn:50 Sprd:50 (H/P)50
  (Balance) 100% 63**OFF**00+00
  
```

1-2 Speed Switch [SLOW, FAST]
Switch the rotation speed (slow/fast) of the speaker.

1-3 Speed Switching Source (Mod.Source List 2)
Select a modulation source (see p.104) that will control the "Speed Switch." When "Speed Switch" is SLOW, the rotation will normally be SLOW, and will accelerate to FAST only when you operate the modulation source (by pressing the pedal, etc.). The speed will switch to FAST when the value of the modulation source rises to 64 or higher. For values of 63 or lower, the speed will be SLOW.

2-2 Mode Switch [ROTATE, STOP]
Switch the speaker between rotating/stopped.

2-3 Mode Switching Source (Mod.Source List 2)
Select a modulation source (see p.104) that will control the "Mode Switch." If "Mode Switch" is set to ROTATE, the speaker will be rotating, and will stop only when the modulation source is operated (e.g., when a pedal is pressed). Rotation will STOP when the modulation source value reaches 64 or higher, and will ROTATE when the value is 63 or less.

3-2 Rotor Acceleration [0...99]
Specify the rapidity with which the rotational speed of the low frequency rotor will change. On an actual rotary speaker, the speed does not switch immediately between fast/slow, but accelerates or decelerates over an interval of time. Here you can specify the rapidity at which this change will take place.

3-3 Rotor Ratio [00...99]
Adjust the rotational speed of the low frequency rotor. 50 is normal, and 0 is stopped.

4-2 Horn Acceleration [0...100]

Specify the rapidity with which the rotational speed of the high frequency horn will change.

4-3 Horn Ratio [Stop, 0.50...2.00]

Adjust the rotational speed of the low frequency rotor. 50 is normal, and 0 is stopped.

5-2 Mic Distance [00...50]

This simulates the distance at which the mics are placed. This setting simulates a stereo mic placement.

5-3 Mic Spread [0...50]

Specify the left/right angle of the microphones.

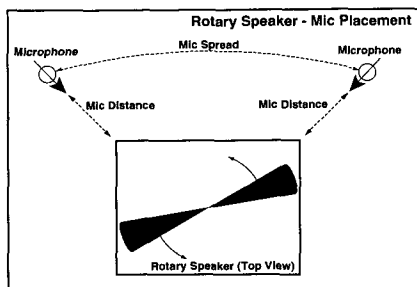

5-4 Rotor/Horn Balance [Rotor, 1...99, Horn]

Specify the volume balance between the low frequency rotor and the high frequency horn.

6-2 Effect Balance [0...100%]

Specify the balance between the effect sound (Wet) and the direct sound (Dry).

6-3 Balance Mod.Source (Mod.Source List 2)

Select a modulation source (see p.104) that will control "Effect Balance."

6-4 Balance Mod.Intensity [-99...+99]

Specify the depth and direction of the effect of "Balance Mod.Source."

Fx2 page

Specify the effect that Fx2 will use

Fx2 can use Overdrive to Delay (Mono) effects (see p.64 to 71).

Mst.Fx page

Specify the effect that Mst.Fx will use

Stereo Delay

This is a stereo-type delay. You can change the feedback connections and use it as a cross-feedback delay in which the delayed sound will alternate between left and right.

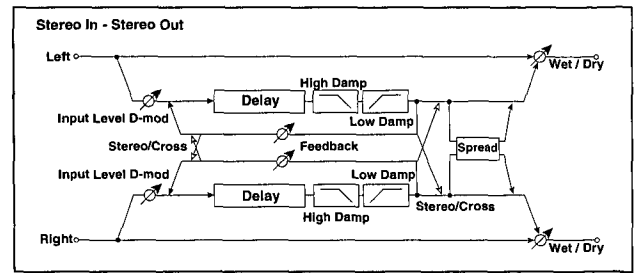

```

1  <Master>R( UN) Type
2  <Stereo Delay>
3  Type:STEREO
4  <InputLevelMod.> MS**OFF**00+00
5  <TimeInSl>L:280 R:286
6  <Fdbck> L:+35 R:+36 MS**OFF**00+00
   <Damp> Low:00 High:00
   <Balance> 026% MS**OFF**00+00

```

1-1 Type [STEREO, CROSS]

Switch the delay type between stereo delay or cross-feedback delay.

2-4 Input Level Mod.Source (Mod.Source List 2)

Select a modulation source (see p.104) that will control the input level. Refer to Delay (Mono).

2-5 Input Level Mod.Intensity [-99...+99]

Specify the depth and direction of the effect of "Input Level Mod.Source."

3-2 Left Time [0...680 ms]

Specify the delay time of the left channel.

3-4 Right Time [0...680 ms]

Specify the delay time of the right channel.

4-2 Left Feedback [-99...+99]

Specify the amount of feedback for the left channel.

4-3 Right Feedback [-99...+99]

Specify the amount of the feedback for the right hand.

4-4 Feedback Mod.Source (Mod.Source List 2)

Select a modulation source (see p.104) that will control "Feedback."

4-5 Feedback Mod.Intensity [-100...+100]

Specify the depth and direction of the effect that "Feedback Mod.Source" will have.

5-2 Low Damp [0...99]

Specify the attenuation of the low frequency range. This will cause the delay sound to become successively lighter in tone each time it is fed back.

5-4 High Damp [0...99]

Specify the attenuation of the high frequency range. This will cause the delay sound to become successively darker in tone each time it is fed back.

6-2 Effect Balance [0...100%]

Specify the balance between the effect sound (Wet) and the direct sound (Dry).

6-3 Balance Mod.Source (Mod.Source List 2)
 Select a modulation source (see p.104) that will control "Effect Balance."

6-4 Balance Mod.Intensity [-99...+99]
 Specify the depth and direction of the effect of "Balance Mod.Source."

Reverb-Hall

This effect simulates the reverberation and ambiance of a mid-sized concert hall or ensemble hall.

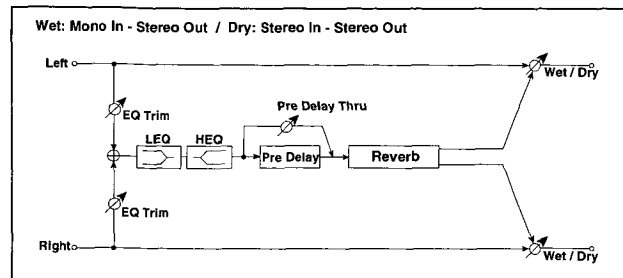

```

1  [Master] [ON] > Reverb Time 0.210
2  <Reverb(Hall)>
3  (PreDly)DlyT:010[mS] Thru:20
4  (HiDamp) 15
5  (PreEQ) Trim:99 LoG+00.0 HiG+00.0
6  (Balance) 010% ON *OFF* *ON +00
  
```

1-2 Reverb Time [0.1...10.0 S]
 Specify the reverb time.

2-2 Pre Delay Time [0...200 mS]
 Specify the delay time for the input to the reverb. This will control the spaciousness of the simulated room.

2-4 Pre Delay Thru Level [0...99]
 Specify the proportion at which the undelayed sound will be mixed. By mixing in some of the undelayed sound you can emphasize the sense of attack.

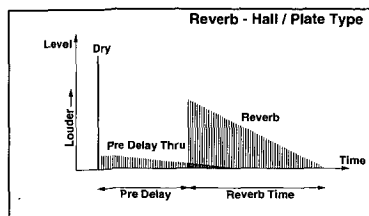

3-2 High Damp [0...99]
 Specify the amount of high frequency attenuation.

4-2 Pre EQ Input Trim [0...99]
 Specify the input level to the equalizer.

4-3 Pre Low EQ Gain [-18.0...+18.0 dB]
 Specify the gain of the low range equalizer.

4-4 Pre High EQ Gain [-18.0...+18.0 dB]
 Specify the gain of the high range equalizer.

5-2 Effect Balance [0...100%]
 Specify the balance between the effect sound (Wet) and the direct sound (Dry).

5-3 Balance Mod.Source (Mod.Source List 2)
 Select a modulation source (see p.104) that will control "Effect Balance."

5-4 Balance Mod.Intensity [-99...+99]
 Specify the depth and direction of the effect of "Balance Mod.Source."

Reverb-Room

This reverb effect emphasizes the early reflections, simulating a tight feeling room. By adjusting the balance of the early reflections and the reverberation, you can control the quality of the walls of the simulated room.

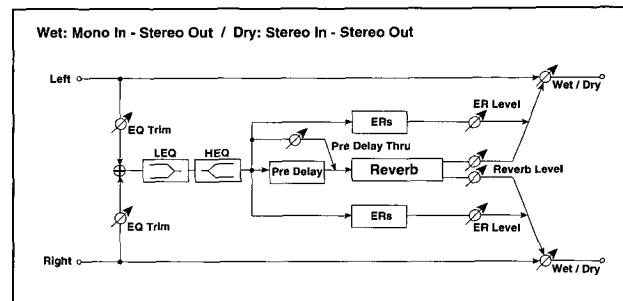

```

1  [Master] [ON] > Reverb Time 0.210
2  <Reverb(Room)>
3  (PreDly)DlyT:010[mS] Thru:00
4  (HiDamp) 50
5  (Level) ER:50 Rev:80
6  (PreEQ) Trim:99 LoG+00.0 HiG+00.0
7  (Balance) 030% ON *OFF* *ON +00
  
```

1-2 Reverb Time [0.1...3.0 S]
 Specify the reverb time.

2-2 Pre Delay Time [0...200 mSec]
 Specify the delay time for the input to the reverb. This will control the spaciousness of the simulated room.

2-4 Pre Delay Thru Level [0...99]
 Specify the proportion at which the undelayed sound will be mixed. By mixing in some of the undelayed sound you can emphasize the sense of attack.

3-2 High Damp [0...99]
 Specify the amount of high frequency attenuation.

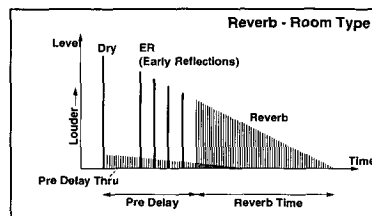

4-2 Early Reflection Level [0...99]
 Specify the level of the early reflections. By changing

Program Edit
MultiSet Edit

Effect Type

the proportion of the "Early Reflection Level" and the "Reverb Level," you can control the quality of the walls in the simulated room. Increasing "Early Reflection Level" will produce a harder feel, and increasing "Reverb Level" will produce a softer feel.

- 4-3 Reverb Level** [0...99]
Specify the reverb level.
- 5-2 Pre EQ Input Trim** [0...99]
Specify the input level to the equalizer.
- 5-3 Pre Low EQ Gain** [-18.0...+18.0dB]
Specify the gain of the low range equalizer.
- 5-4 Pre High EQ Gain** [-18.0...+18.0dB]
Specify the gain of the high range equalizer.
- 6-2 Effect Balance** [0...100%]
Specify the balance between the effect sound (Wet) and the direct sound (Dry).
- 6-3 Balance Mod.Source** (Mod.Source List 2)
Select a modulation source (see p.104) that will control "Effect Balance."
- 6-4 Balance Mod.Intensity** [-99...+99]
Specify the depth and direction of the effect of "Balance Mod.Source."

.....

Mst.EQ page

Make settings for the Mst.EQ

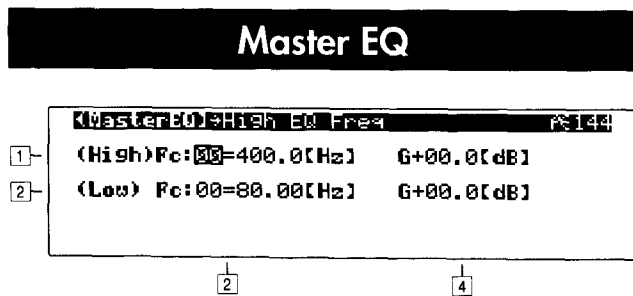

- 1-2 High EQ Freq** [0...49 (1.0 kHz...29.9 kHz)]
Specify the center frequency of the high EQ.
- 1-4 High EQ Gain** [-18.0...+18.0 dB]
Specify the gain of the high EQ.
- 2-2 Low EQ Freq** [0...49 (20.0 Hz...1.4 kHz)]
Specify the center frequency of the low EQ.
- 2-4 Low EQ Gain** [-18.0...+18.0 dB]
Specify the gain of the high EQ.

Editing a MultiSet (MultiSet Edit mode)

1. Multi Timbre section

Here you can specify a program and the maximum polyphony for each timbre 1 to 6.

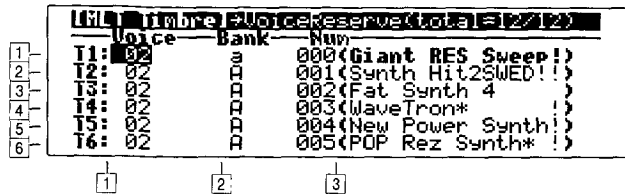

Specify the maximum polyphony for each timbre

***-1 Voice Reserve (total= **/12)** [OFF, 1...12]
Specify the maximum polyphony for each timbre. The total of all settings for T1 to 6 cannot exceed the total polyphony of the Z1. The current total is indicated in "**."

To finalize the setting that you made, press the [ENTER] key. If you enter 0, that timbre will be OFF.

If an optional <DSPB-Z1 option board> is installed, six voices will be added, and the display will indicate "Voice Reserve (total=**/18)" (see p.109).

Specify the program for each timbre

***-2 Program Bank** [A, B]

***-3 Program Number** [0...127]

Specify the program that will be assigned to each timbre. Specify the program bank in "Program Bank," and the program number in "Program Number."

Press the [ENTER] key to finalize the setting.

Only internal programs can be selected for an internal MultiSet. Only card programs can be selected for a card MultiSet.

2. Multi Mixer section

Here you can specify the volume, panpot, and effect balance for each timbre. You can either specify these settings independently for each timbre of the MultiSet, or use the settings that are already specified for each program.

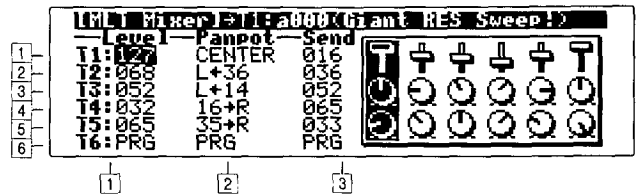

Specify the volume of each timbre

***-1 Level.....** [0...127, PRG]

Specify the volume of each timbre. With a setting of PRG, the "Output Level" (AMP section) setting of the program assigned to the timbre will be used.

Specify the panpot of each timbre

***-2 Panpot** [LEFT...CENTER...RIGHT, PRG]

Specify the panpot of each timbre. With a setting of PRG, the "Panpot" (AMP section) setting of the program assigned to the timbre will be used.

Specify the output level of each timbre to the effects

***-3 Send.....** [0...100%, PRG]

Specify the output level of each timbre to effects 1 and 2, and to the master effect. As this value is increased, the proportion of the signal that is output to effects 1 and 2 will increase.

With a setting of PRG, the "Effect Send" (Prog FX section) settings of the program assigned to the timbre will be used.

3. Multi Zone section

Here you can specify the note range and velocity range for which each timbre will sound. These settings allow you to create split, layered and velocity switched MultiSets. Values for these parameters can be input using the keyboard (see p.14 and p.22).

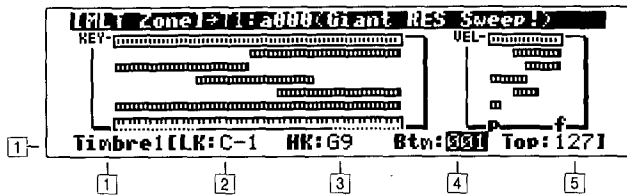

- Selecting the timbre for which you wish to make note range or velocity range settings**

1-1 Timbre [1...6]
Rotate knob [1] to select the timbre for which you wish to make settings.

- Specify the range of notes for which the timbre will sound**

1-2 Low Key (LK) [C-1...G9]
Specify the lowest key for which the selected timbre will sound.

1-3 High Key (HK) [C-1...G9]
Specify the highest key for which the selected timbre will sound.

- Specify the range of velocities for which the timbre will sound**

1-4 Velocity Bottom (Btm) [1...127]
Specify the minimum velocity value for which the selected timbre will sound.

1-5 Velocity Top (Top) [1...127]
Specify the maximum velocity value for which the selected timbre will sound.

4. Multi Pitch section

Here you can specify the pitch and scale for each timbre. You can either make these settings independently for each timbre of the MultiSet, or you can use the settings of each program.

	Xpose	Detune	Scale
1	T1: +00	+00	PRG
2	T2: +00	+00	PRG
3	T3: +00	+00	PRG
4	T4: +00	+00	PRG
5	T5: +00	+00	PRG
6	T6: +00	+00	PRG

- Transpose each timbre**

***-1 Xpose** [-24...+24]
Adjust the pitch of each timbre in semitone (100 cent) steps. 12 steps equal one octave.

- Make fine adjustments to the pitch of each timbre**

***-2 Detune** [-50...+50]
Make fine adjustments to the pitch of each timbre in 1 cent steps. A setting of 0 is the normal pitch.

- Specify the scale for each timbre**

***-3 Scale** [CMN, PRG]
With a setting of CMN, the "Scale Type" and "Scale Key" (Multi Common section) settings will be used. With a setting of PRG, the scale specified by the program of each timbre will be used.



5. Multi MIDI & Arpeggio section

For each timbre, you can specify the MIDI transmit and receive channel, and specify whether or not program change messages from an external MIDI device will switch timbre programs. Here you can also specify timbres that will be played by the arpeggiator.

	MIDI Ch	Prog. Change	Arpeggio
1	T1: GLB	DIS	ENA
2	T2: GLB	DIS	ENA
3	T3: GLB	DIS	ENA
4	T4: GLB	DIS	ENA
5	T5: GLB	DIS	ENA
6	T6: GLB	DIS	ENA

Specify the MIDI channel of each timbre

*-1 MIDI. Ch [1...16, GLB]

Specify the MIDI transmit and receive channel (1 to 16) for each timbre. With a setting of GLB, the MIDI channel of that timbre will always match the Global MIDI channel setting (MIDI mode "Global Channel"). In order to play a MultiSet from the keyboard or the arpeggiator, the MIDI channel ("MIDI. Ch" setting) of the program you wish to play must match the "Global Channel." If you set a timbre to GLB, you will always be able to play it from the keyboard even if you change the "Global Channel."

When using an external MIDI sequencer, you can set the MIDI channel of each timbre to match the MIDI channels for each track of the sequencer, so that up to 6 tracks of the sequence can be played by the Z1 functioning as a multi-timbral tone generator.

With a setting of 1 to 16, an indication of "G" will appear beside the numerical value if the setting is the same as the current "Global Channel."

Specify whether or not MIDI program change messages will be received by each timbre

*-3 Prog. Change [DIS, ENA]

When timbres with a setting of ENA (Enable) receive a MIDI program change message, they will switch programs. With a setting of DIS (Disable), MIDI program change messages will be ignored, and the program will not change.

However, this setting is affected by the MIDI mode setting "Program Change Receive." You can choose whether program changes will be completely ignored, whether the MultiSet will change, or whether the program of a timbre will change (see p.87 and p.98).

Be aware that timbres which are set to the same MIDI channel will switch to the same program if they receive a MIDI program change message.

Be aware that the sound will be interrupted if a program change occurs for a timbre while you are playing.

Specify the timbres that will be played by the arpeggiator

*-5 Arpeggio [DIS, ENA]

When the arpeggio function is on, playing the keyboard will cause arpeggios to play on each timbre which is set to ENA (Enable). Timbres which are set to DIS (Disable) will not play arpeggios, but can be played normally from the keyboard.

This setting will be ignored by timbres which are set to other than the Global MIDI channel.

MultiSet Edit

Control MIDI Pitch Zone

6. Multi Control Filter section

Here you can specify how each timbre will react to controllers and various MIDI messages.

MLT Ctl Fltr P1 page

	PBend	ATouch	Mod. Whl	Pad	Damper
1	T1: CMN	ENA	ENA	ENA	ENA
2	T2: CMN	ENA	ENA	ENA	ENA
3	T3: CMN	ENA	ENA	ENA	ENA
4	T4: CMN	ENA	ENA	ENA	ENA
5	T5: CMN	ENA	ENA	ENA	ENA
6	T6: CMN	ENA	ENA	ENA	ENA

Specify how each timbre will respond to MIDI messages

- *-1 **PBend** [DIS, CMN, PRG]
 With a setting of **DIS**, movements of the [PITCH BENDER] and MIDI pitch bend messages will be ignored.
 With a setting of **CMN**, the settings of the Multi Common section (Pitch Bend) will be used.
 With a setting of **PRG**, the settings of the OSC section (Pitch Bend) of the program assigned to each timbre will be used.
- *-2 **ATouch** [DIS, ENA]
 Aftertouch will be ignored with a setting of **DIS**, and enabled with a setting of **ENA**.
- *-3 **Mod. Whl** [DIS, ENA]
 The [MOD WHEEL] and MIDI control change #1 will be ignored with a setting of **DIS**, and enabled with a setting of **ENA**.
- *-4 **Pad** [DIS, ENA]
 The [X-Y PAD] and MIDI control changes #16 and #17 will be ignored with a setting of **DIS**, and enabled with a setting of **ENA**.
- *-5 **Damper** [DIS, ENA]
 [DAMPER], the [ASSIGNABLE SW] to which the **Damper** function has been assigned, and MIDI control change #64 will be ignored with a setting of **DIS**, and enabled with a setting of **ENA**.

MLT Ctl Fltr P2 page

	PrtmSW	RT Edit	P Edit	Others
1	T1: ENA	ENA	ENA	ENA
2	T2: ENA	ENA	DIS	ENA
3	T3: ENA	ENA	DIS	ENA
4	T4: ENA	ENA	DIS	ENA
5	T5: ENA	ENA	DIS	ENA
6	T6: ENA	ENA	DIS	ENA

*-1 **PrtmSW** [DIS, ENA]
 The [Portamento] key and MIDI control change #65 will be ignored with a setting of **DIS**, and enabled with a setting of **ENA**.

*-2 **RT Edit** [DIS, ENA]
 The realtime editor and MIDI control changes #24 to #31, #76 to #79, #83, and #85 to #90 will be ignored with a setting of **DIS**, and enabled with a setting of **ENA**.

*-3 **P Edit** [DIS, ENA]
 The performance editor and MIDI control changes #19 to #23 will be ignored with a setting of **DIS**, and enabled with a setting of **ENA**. Only one of the six timbres can be set to **ENA**.

*-4 **Others** [DIS, ENA]
 Other controllers and other MIDI control changes # will be ignored with a setting of **DIS**, and enabled with a setting of **ENA**.

The MIDI control change # numbers given above are the factory setting values, or the values that result when you use the MIDI mode page "MIDI CChg Filter" UTILITY: knob [5] [Reset] function to reset MIDI control change translation (or when you make the identical settings).

Controller operations will have an effect if the MIDI channel of the timbre is the "Global Channel." If a timbre is set to other than the "Global Channel," the control changes corresponding to each controller will have an effect.

Each of the functions assigned to Assignable SW, SW1 and SW2 will be enabled/disabled by the filters shown below.
 (-----: In the case of these parameters, no filter applies.)

SW	Ctl Fltr	SW	Ctl Fltr
MOD.SW1	Others	Fx2_SW	-----
MOD.SW2	Others	Oct_Up	-----
FootSW	Others	OctDown	-----
Damper	Damper	MONO_SW	Others
PrtmSW	PrtmSW	UNISON	Others
Sostnut	Others	ArpegSW	-----
M.Fx_SW	-----	PadHold	-----
Fx1_SW	-----		



7. Multi Fx section

Here you can make effect settings for the MultiSet. The structure is basically the same as the Prog Fx section. The "Effect Send" function of the Prog Fx section corresponds to the "Send" setting of the Multi Mixer section. A MultiSet does not have a setting that corresponds to the "Effect Send Mod.Src" and "Effect Send Mod.Int" settings of the Prog Fx section.



MLT Effect Set Up page (Multi Fx)

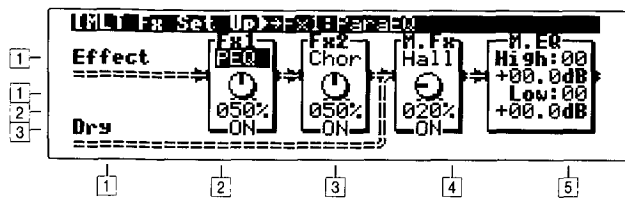

Select the effect type for Fx1

1-2 Fx1 Select [OD...RSpL]
 Select the effect type for effect 1. The available types are the same as for a program.
 For details on each type, refer to the explanation in "Effect types" (p.64).

2-2 Fx1 Balance [0...100%]

3-2 Fx1 SW [OFF, ON]
 Refer to "7. Prog Fx section" "Fx1 Balance" and "Fx1 SW" (p.59).

Select the effect type for Fx2

1-3 Fx2 Select [OD...dly]
 Select the effect type for effect 2. The available types are the same as for a program.
 For details on each type, refer to the corresponding explanation.

2-3 Fx2 Balance [0...100%]

3-3 Fx2 SW [OFF, ON]
 Refer to "7. Prog Fx section" "Fx1 Balance" and "Fx1 SW" (p.59).

Select the effect type for Mst.Fx

1-4 Master FX Select [Dly...Room]
 Select the effect type for the master effect. The available types are the same as for a program.
 For details on each type, refer to the corresponding explanation.

2-4 Master Fx [0...100%]

3-4 Master Fx SW [OFF, ON]
 Refer to "7. Prog Fx section" "Fx1 Balance" and "Fx1 SW" (p.59).

Specify the gain of the Mst.EQ

Specify the settings of the 2-band EQ that is applied to the output signal.

1-5 High EQ Frequency [0 (1.00 kHz)...49 (29.9 kHz)]
 Specify the cutoff frequency of the high EQ.

2-5 Low EQ Gain [-18.0...+18.0 dB]
 Specify the gain of the high EQ.

3-5 Low EQ Frequency [0 (20.0 Hz)...49 (1.4 kHz)]
 Specify the cutoff frequency of the low EQ.

4-5 Low EQ Gain [-18.0...+18.0 dB]
 Specify the gain of the low EQ.

8. Multi Common section

Here you can assign a name to the MultiSet, and make settings for pitch bend, scale, and the functions of the [SW1] key, [SW2] key, [Assignable SW] and [Assignable Pedal].

MLT CMN Scale page

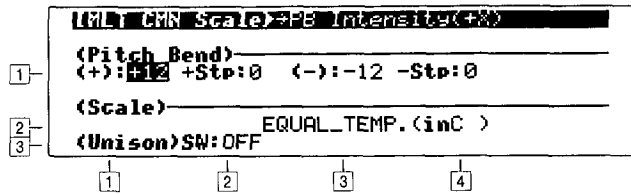

Specify the pitch bend width for the MultiSet

- 1-1 PB Intensity (+X) [-60...+24]
- 1-2 PB Step (+X) [0, /8, /4, /2, 1...12]
- 1-3 PB Intensity (-X) [-60...+24]
- 1-4 PB Step (-X) [0, /8, /4, /2, 1...12]

Specify the pitch bend width for the MultiSet. Timbres whose MLT Ctl Fltr P1 page "PBend" parameter is set to CMN will use these settings.

For details refer to "Specifying the pitch bend width" (p.31).

Specify the scale for the MultiSet

- 2-3 Scale Type [EQUAL_TEMP...USER_SCALE2]
- 2-4 Scale Key [C...B]

Specify the scale for the MultiSet. Timbres whose MLT Pitch page "Scale" parameter is set to CMN will use these settings.

For details refer to "Selecting the scale type" (p.61).

3-2 Unison SW [OFF, ON]

This turns unison on/off. By setting either "SW1 Function," "SW2 Function" or "AssignableSW Function" to UNISON, you can control this from the various Play modes (refer to p.62).

MLT CMN SW & Pdl page

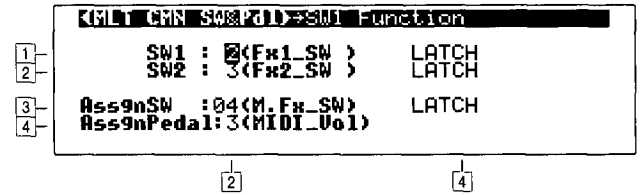

Specify the function of [SW1] and [SW2] for the MultiSet

- 1-2 SW1 Function [0...7]
- 1-4 SW1 Mode [LATCH, UNLAT]
- 2-2 SW2 Function [0...7]
- 2-4 SW2 Mode [LATCH, UNLAT]

For details refer to "Specify the function of [SW1] and [SW2]" (p.62).

Specify the function of each pedal for the MultiSet

- 3-2 Assignable SW Function [0...12]
- 3-4 Assignable SW Mode [LATCH, UNLAT]
- 4-2 Assignable Pedal Function [0...4]

For details refer to "Specify the function of each pedal" (p.62).

MLT CMN Name page

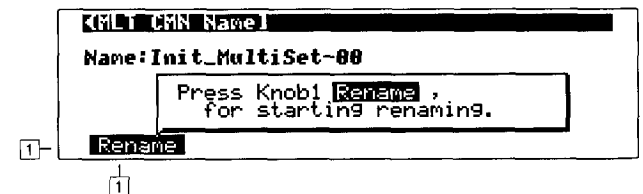

Modify the name of the MultiSet

- 1-1 Name Edit Specify the name of the MultiSet.

For details and the procedure, refer to "Modifying a name (Rename)" (p.25).

Editing an arpeggio pattern (Arpeggio mode)

In this mode you can make various settings related to the arpeggiator. For each pattern, you can specify basic items such as the length and loudness of each note. In addition, user patterns (U1-1 to U1-5, U2-1 to U2-5, U3-1 to U3-5) are freely programmable, allowing you to specify parameter parameters for up to 36 steps. The arpeggio pattern that is currently selected in Program Play mode or MultiSet Play mode will be the pattern to which your editing will apply. After modifying the pattern, you will need to exit Arpeggio mode and re-select the pattern.

PAT Basic page

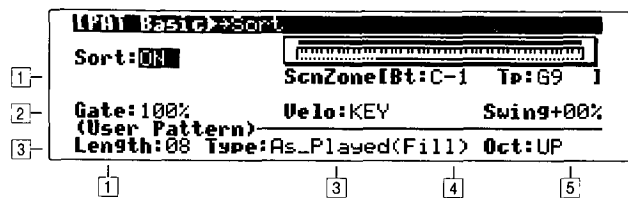

Specify the basic operation of the pattern

Here you can specify basic data such as the length, loudness, and timing of each note in the arpeggio.

1-1 Sort [OFF, ON]

When two or more keys pressed simultaneously are sounded as an arpeggio, a setting of ON for this parameter will cause the notes to always be sounded as a broken chord in the order of the note pitches (regardless of the order in which the notes were played). With a setting of OFF, the notes of the arpeggio will follow the order in which the keys were pressed.

1-4 Kbd ScanZone Bottom [C-1...G9]

1-5 Kbd ScanZone Top [C-1...G9]

These settings allow you to limit the range of the keyboard which will control the arpeggiator. Notes between the "Kbd ScanZone Bottom" and the "Kbd ScanZone Top" will be used to produce arpeggios. These parameters can be input from the keyboard.

2-1 Gate [000...100%, (STEP)]

This controls the length (Gate) of the arpeggio notes. When a user pattern (U1-1 to U3-5) is selected, a setting of STEP for this parameter will cause the step parameter "Gate" settings (PAT Step Param page) to be used.

You can also control the length of the arpeggio notes by rotating the [GATE] knob. Rotating the knob toward the left will shorten the notes, and rotating it toward the right will lengthen them. When the knob is in the 12 o'clock position, the notes will have the gate length that is specified by this parameter.

2-3 Velocity [1...127, KEY, (STEP)]

Specify the velocity of the arpeggio notes. With a setting of 1 to 127, the arpeggiated notes will always be sounded with the specified velocity value. With a setting of KEY, the velocity with which each key was played will be used. If a user pattern (U1-1 to U3-5) is selected, a setting of STEP will cause the settings of the step parameter "Velocity" (PAT Step Param page) to be used.

You can also control the velocity of the arpeggio notes by rotating the [VELOCITY] knob. Rotating the knob toward the left will give the notes a lower velocity, and rotating it toward the right will give them a higher velocity. When the knob is in the 12 o'clock position, the notes will have the velocity value that is specified by this parameter.

2-5 Swing [-50...+50%]

This parameter slides the timing of the even-numbered (as counted from the beginning) notes of the arpeggio in the specified direction. The result is a musically pleasing triplet feel.

[When RESOLUTION= eighth note]

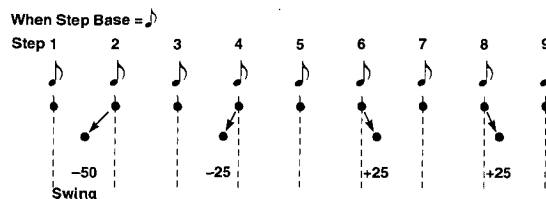

PAT User Type

These parameters will be available if a user pattern has been selected.

3-1 Pattern Length [01...36]

Specify the length of the pattern. After the note value specified by the [RESOLUTION] knob has been played for the number of times specified by this parameter, the pattern will return to the beginning.

3-3 Arpeggio Type [As_Played...UP&DOWN]

Specify the correspondence between the arpeggio notes that were specified by the keyboard and the "Tone" for each step (the "●" displayed in the PAT Step Param page).

As_Played:

If the "Tone" settings for a step exceed the number of arpeggio notes that are specified (i.e., played on the keyboard), that step will not sound.

As_Played (FILL):

If the "Tone" settings for a step exceed the number of arpeggio notes that are specified (i.e., played on the

keyboard), the last arpeggio note (the last pressed note if "Sort" is OFF, or the highest note if "Sort" is ON) will be sounded.

Running_UP:

If the "Tone" settings for a step exceed the number of arpeggio notes that are specified (i.e., played on the keyboard), the arpeggio will return to the first note (the first-pressed note if "Sort" is OFF, or the lowest-note if "Sort" is ON) and sound it.

UP&DOWN:

If the "Tone" settings for a step exceed the number of arpeggio notes that are specified (i.e., played on the keyboard), the arpeggio will reverse direction from the last arpeggio note and continue sounding.

Example: When "Tone" 0 to 3 are played repeatedly with a "Length" of 4

Three keys pressed with a setting of **As Played**:

0 → 1 → 2 → rest → 0 → 1 → 2 → rest → 0 ...

Three keys pressed with a setting of **As Played (FILL)**:

0 → 1 → 2 → 2 → 0 → 1 → 2 → 2 → 0 ...

Three keys pressed with a setting of **Running_UP**:

0 → 1 → 2 → 0 → 0 → 1 → 2 → 0 → 0 ...

Three keys pressed with a setting of **UP&DOWN**:

0 → 1 → 2 → 1 → 0 → 1 → 2 → 1 → 0 ...

3-5 Octave Motion [UP, DOWN, BOTH, PARA]

Specify the operation when the [OCTAVES] key is set to 2 to 4 octaves.

UP: Ascend repeatedly for the specified number of octaves.

DOWN: Descend repeatedly for the specified number of octaves.

BOTH: Ascend and descend repeatedly for the specified number of octaves.

PARA: Sound notes in parallel for the specified number of octaves.

PAT Step Param page

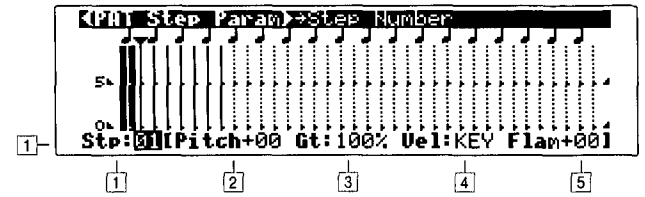

Specify the Step Tone

For each of a maximum of 36 steps, you can specify Tones 0 to 9 to distinguish the pitches of up to 10 keys that are pressed simultaneously. If the PAT Basic page "Sort" setting is ON, Tones 0 to 9 will correspond respectively to the lowest through the highest keys that were pressed. If the PAT Basic page "Sort" setting is OFF, Tones 0 to 9 will correspond respectively to the first through the last keys that were pressed.

To input "Tone" settings, move the cursor to "StepNumber" and use the numeric keys.

1-1 StepNumber [1...36]

- ① Either rotate knob [1] or press the [+] or [-] key or the [▼] or [▲] key to select the step that you wish to edit. Even if the cursor is located at another parameter, you can use the [▼] or [▲] key to move it.
- ② Press numeric keys [0] to [9] to input the "Tone." Tone 0 to 9 correspond to numeric keys [0] to [9] respectively. Pressing a key will set/reset the corresponding Tone.
- ③ To erase all "Tone" settings in a step, you can use UTILITY:[Delete] (knob [4]). To insert a blank step, you can use UTILITY:[Insert] (knob [5]) (see p.106).

Specify parameters for each Step

1-2 Pitch Offset [-48...+48]

Raise or lower the pitch of the tone for each step, in semitone units. You can specify the same tone for each step and play a melody, or specify multiple tones for each step and play parallel chords.

1-3 Velocity [1...127, KEY]

With a setting of KEY, the velocity with which the note was played will be used. This setting of this parameter is used only if "Velocity" (PAT Basic page) is set to STEP.

1-4 Gate [OFF, 1...100%, LGAT]

With a setting of OFF, that step will not sound even if a "Tone" is specified.

With a setting of LGAT (Legato), the note will continue to sound until either the same "Tone" is played again or the pattern returns to the beginning.

The setting of this parameter is used only if "Gate" (PAT Basic page) is set to STEP.

1-5 Flam [-99...+99]

Specify how note timing will be skewed when multiple tones are specified for the same step.

With a setting of 00, all "Tones" will sound simultaneously.

With a setting of +01 to +99, "Tones" will sound separately in numerical order (from the lowest note if "Sort" is ON, or in the order played if "Sort" is OFF).

With a setting of -01 to -99, "Tones" will sound separately in the opposite order from "+".

When simulating chords strummed on a guitar, it is effective to set odd numbered steps to a positive (+) value and even-numbered steps to a negative (-) value.

.....
PAT Pattern Name page

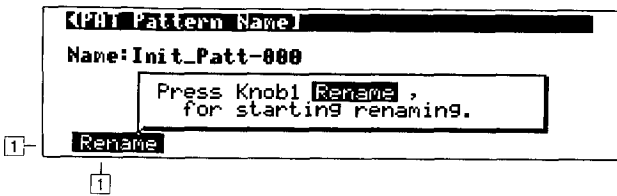

□ Modifying the name of an arpeggio pattern

1-1 Name Edit

The name of arpeggio pattern can be assigned.

For details and the procedure, refer to "Modifying a name (Rename)" (p.25).

MIDI-related settings (MIDI mode)

In MIDI mode you can make various settings that affect how the Z1 will transmit and receive MIDI messages.

Settings which you make in this mode are remembered without your having to execute the Write operation.

MIDI Basic page

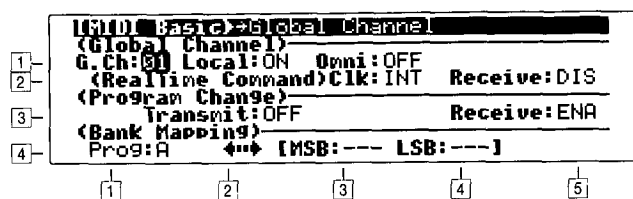

Specify the Global MIDI channel

1-1 Global channel [1...16]

Specify the Global MIDI channel.

The following data can be exchanged with an external MIDI device on the Global MIDI channel.

All musical data in Program Play mode, MultiSet number selections and keyboard and controller operations in MultiSet Play mode, and transmission and reception of system exclusive messages.

In order to exchange these types of MIDI messages, the MIDI channel of the other MIDI device must match the Global MIDI channel of the Z1.

Local on/off setting

1-2 Local Control [OFF, ON]

With a setting of OFF, the keyboard and controllers will be disconnected from the tone generator. However performance data will still be transmitted from MIDI OUT.

Normally you will leave this parameter ON, but when a sequencer etc. is connected to the Z1, turn this setting OFF to prevent each note from being triggered twice (once when played from the Z1's own keyboard and again when the note-on message is passed on by the sequencer).

Omni on/off setting

1-3 Omni [OFF, ON]

With a setting of OFF, MIDI messages will be transmitted and received on the specified "Global MIDI channel."

With a setting of ON, MIDI messages will be transmitted on the "Global MIDI channel," and received on all channels (1 to 16).

Synchronizing the Z1 and an external MIDI device

2-3 Clock Source [INT, EXT]

Select the INT (Internal) setting if you are using the Z1 by itself, or if you wish to use the Z1 as the master device (the device that will specify the timing for all other devices). This will allow an external MIDI device (sequencer, drum machine etc.) to be synchronized to the arpeggiator of the Z1, and for the frequency of the LFO to be synchronized to the internal MIDI clock. In this case, MIDI Clock messages will be transmitted from the Z1 at the tempo specified by the arpeggiator [SPEED] knob.

Select the EXT (External) setting when you wish to use the Z1 as a slave device (a device that will be controlled by another device). This will allow the MIDI Clock messages from an external MIDI device to control the Z1's arpeggiator and LFO frequency.

When synchronizing the Z1 and an external MIDI device, please refer to the owner's manual for the other device as well.

Synchronizing an external MIDI device to the Z1's arpeggiator

- 1 If you wish to synchronize an external MIDI device (sequencer or rhythm machine etc.) to the Z1's arpeggiator, use a MIDI cable to connect the Z1's MIDI OUT to the external MIDI device's MIDI IN (see p.97).
- 2 Set the Z1's "Clock Source" to INT.
- 3 Make settings on the external MIDI device so that it will receive MIDI clock messages (i.e., set it to be the slave device).
- 4 When you start the external MIDI device, it will operate in synchronization to the tempo that is set by the Z1's [SPEED] knob.
- 5 Turn on the ARPEGGIATOR [ON/OFF] key to start the arpeggiator.

Synchronizing the Z1's arpeggiator to an external MIDI device

- 1 Use a MIDI cable to connect the Z1's MIDI IN to the external MIDI device's MIDI OUT.
- 2 Set "Clock Source" to EXT.
- 3 Make settings on the external MIDI device so that it will transmit MIDI clock messages (i.e., set it to be the master device).
- 4 Turn on the ARPEGGIATOR [ON/OFF] key, and play a note. If "RealTimeCommand Receive" is DIS, the arpeggio will play in synchronization with the tempo of the external MIDI device. If it is ENA, the arpeggiator will play when the external MIDI device is started.

2-5 RealTimeCommand Receive [DIS, ENA]

If "Clock Source" is set to EXT, a setting of ENA (for this parameter) will cause the MIDI messages Start/Stop/Continue and Song Position Pointer to be received. In this case, the arpeggio will not begin playing until Start or Continue are received. With a setting of DIS, Start/Stop/Continue and Song Position Pointer messages from the external MIDI device will be ignored.

If "Clock Source" is INT, this setting will be ignored.

□ Using MIDI Program Change messages to select sounds

3-2 Program Change Transmit [OFF, ON]

With a setting of ON, MIDI program change messages will be transmitted. With a setting of OFF they will not be transmitted.

When this is ON, selecting a program on the Z1 will cause a program change to be transmitted on the Global MIDI channel.

3-5 Program Change Receive [DIS, ENA, PRG]

With a setting of DIS (Disable), program changes will not be received.

With a setting of ENA (Enable), program changes will be received to select programs, MultiSets, or timbre programs.

With a setting of PRG (Program), program changes will be received to select programs or timbre programs.

ENA and PRG settings differ only in MultiSet Play mode. If the MIDI channel of a timbre matches the Global MIDI channel, a setting of ENA will cause an incoming program change on that channel to select a MultiSet (rather than selecting a timbre program). With a setting of PRG, the MultiSet will not change, and a timbre program will be selected instead. In either case, program changes received on another channel will select a program for the timbre that is receiving that channel. However in order to select timbre programs, "Prog. Change" must be set to ENA. In Program Play mode, ENA and PRG will function in the same way.

□ Specifying the bank on which sound selections (program or MultiSet) will be transmitted/received

4-1 Specified Bank [Prog:A...Multi:CARD B]

Select the sound (program or MultiSet) bank for which you wish to make settings.

4-3 MSB of MIDI Bank Select [---, 0...127]

Specify the MSB of the bank select message that will correspond to the sound (program or MultiSet) bank specified above. With a setting of ---, the bank select message will be ignored.

4-4 LSB of MIDI Bank Select [---, 0...127]

Specify the LSB of the bank select message that will correspond to the sound (program or MultiSet) bank specified above.

MIDI Prog Map page

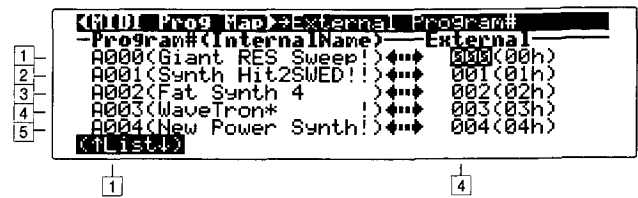

□ Specify the program change numbers that will be transmitted/received in Program Play mode

*-1 Internal Program Select [A0...A127, B0...B127]

*-4 External Program # [0...127]

Use knob [1] (↑ List ↓) to select the Z1 program number, and use knob [4] to select the program change number which will be received/transmitted for that program.

MIDI Multi Map page

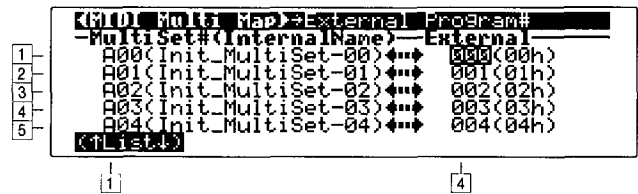

□ Specify the program change numbers that will be transmitted/received in MultiSet Play mode

*-1 Internal Program Select [A00...A15, B00...B15]

*-4 External Program # [0...127]

Use knob [1] (↑ List ↓) to select the Z1 MultiSet number, and use knob [4] to select the program change number which will be received/transmitted for that MultiSet.

MIDI CChg Filter page

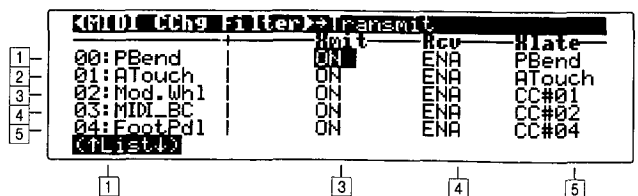

□ Controlling MIDI messages

*-1 MIDI Control Change Source [0...49]

Select the MIDI message that you wish to control.

*-3 MIDI Control Change Transmit [OFF, ON]

With a setting of ON, the MIDI message selected for "MIDI Control Change Source" can be transmitted from MIDI OUT. With a setting of OFF it will not be transmitted.

***-4 MIDI Control Change Receive [DIS, ENA]**

With a setting of ENA (enable), the MIDI message selected for "MIDI Control Change Source" can be received from an external MIDI device (computer, etc.). With a setting of DIS (disable) it will be ignored.

***-5 Translation [PBend, ATouch, CC#00...95]**

The MIDI message selected for "MIDI Control Change Source" will be converted into the MIDI message you specify here (PBend is pitch bend, ATouch is aftertouch, CC#00...95 is control change #0 to 95).

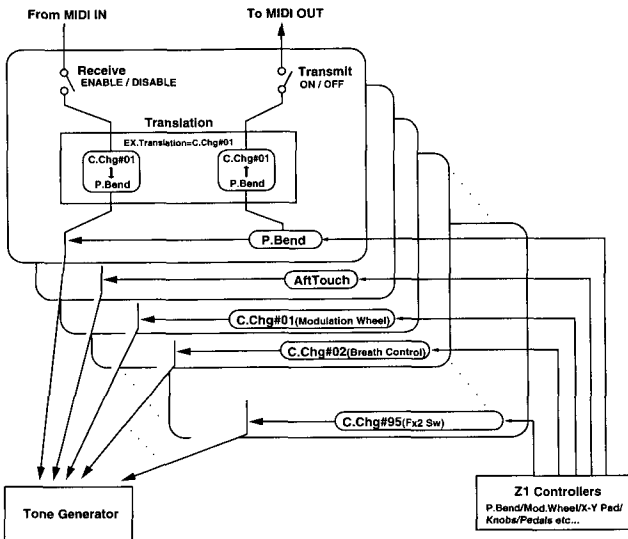

List

00 : PitchBend		25 : Filter1 Cutoff	(CC85)
01 : AfterTouch		26 : Filter1 Resonance	(CC86)
02 : Mod.Wheel	(CC01)	27 : Filter1 EGInt.	(CC87)
03 : MIDI_BreathCtrl	(CC02)	28 : Filter1 Attack	(CC24)
04 : FootPedal	(CC04)	29 : Filter1 Decay	(CC25)
05 : PortamentoTime	(CC05)	30 : Filter1 Sustain	(CC26)
06 : MIDI_Volume	(CC07)	31 : Filter1 Release	(CC27)
07 : MIDI_Pan	(CC10)	32 : Filter2 Cutoff	(CC88)
08 : MIDI_Expression	(CC11)	33 : Filter2 Resonance	(CC89)
09 : Pad_X	(CC16)	34 : Filter2 EGInt.	(CC90)
10 : Pad_Y	(CC17)	35 : Filter2 Attack	(CC28)
11 : Knob1	(CC19)	36 : Filter2 Decay	(CC29)
12 : Knob2	(CC20)	37 : Filter2 Sustain	(CC30)
13 : Knob3	(CC21)	38 : Filter2 Release	(CC31)
14 : Knob4	(CC22)	39 : Amp.Attack	(CC76)
15 : Knob5	(CC23)	40 : Amp.Decay	(CC77)
16 : Damper	(CC64)	41 : Amp.Sustain	(CC78)
17 : PortamentoSW	(CC65)	42 : Amp.Release	(CC79)
18 : Sostenuto	(CC66)	43 : MixOutSW	(CC83)
19 : Mod.SW1	(CC80)	44 : M.Fx_SW	(CC92)
20 : Mod.SW2	(CC81)	45 : Fx1_SW	(CC94)
21 : FootSW	(CC82)	46 : Fx2_SW	(CC95)
22 : Arp.Resolution	(CC09)	47 : Fx Send	(CC91)
23 : Arp.Gate	(CC14)	48 : MONO_SW	(CC18)
24 : Arp.Velocity	(CC15)	49 : Unison	(CC75)

MIDI SystemEX page

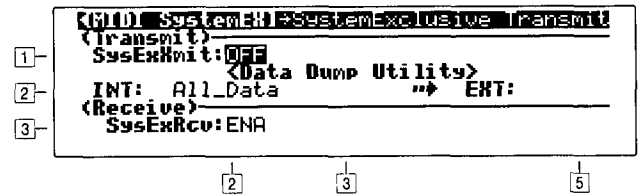

□ Transmitting MIDI system exclusive messages

1-2 SystemExclusive Transmit [OFF, ON]

This setting controls transmission of parameter editing data etc. Normally you will leave this turned OFF. If you are using an external device such as a computer to edit parameters, and messages or data must be transmitted from the Z1, turn this ON.

□ Using data dump to save data on an external MIDI device <Data Dump Utility>

The Z1's programs, MultiSets, arpeggio patterns etc. can be transmitted from MIDI OUT and saved on an external MIDI data filer or computer. This data can also be transmitted to another Z1.

1-2 Data Dump Source [All_Data...GLOBAL&MIDI]

The following data will be transmitted.

- 0: All_Data: All data (the following items 1 to 12)
- 1: All_Program: All internal programs
- 2: ProgBank_A: All programs of internal program bank A
- 3: ProgBank_B: All programs of internal program bank B
- 4: SingleProg: A specified program from internal memory
- 5: All_Multi: All internal MultiSets
- 6: MultiBank_A: All MultiSets of internal MultiSet bank A
- 7: MultiBank_B: All MultiSets of internal MultiSet bank B
- 8: SingleMulti: A specified MultiSet from internal memory
- 9: All_Pattern: All arpeggio patterns from internal memory
- 10: GLOBAL: Global mode data
- 11: MIDI: MIDI mode data
- 12: GLOBAL&MIDI: Global mode and MIDI mode data

2-3 Dump Source Number [A000...B127, A00...B15]

This parameter will appear if "Data Dump Source" number 4 or 8 is selected.

Select the number of the source data that will be transmitted.

2-5 Dump Destination [A000...B127, A00...B15, BANK_A, BANK_B]

This parameter will appear if "Dump Source" number 2, 3, 2, 6, 7 or 8 is selected.

Select the destination bank or number into which the data will be transmitted.

Data transmission procedure

- ① Connect the Z1's MIDI OUT to the MIDI IN of an external MIDI device that can accept a MIDI data dump. In the case of a data filing device, it is normally not necessary to match the MIDI channel. If you are transmitted data to another Z1 so as to rewrite its programs or patterns, set the Global MIDI channels of both devices to the same number.
- ② Use "Data Dump Source" to select the data which will be transmitted. If necessary, select the desired source in "Dump Source Number."

 Depending on the capacity of your data filer, it may not be possible to transmit **All_Program** or **All_Data**. Check the capacity of your data filer before performing a data dump. If your data filer has insufficient capacity, you will have to transmit individual banks or individual programs.

Type of dumped data	Data size
All_Data	183K (182939) bytes
All_Program	169K (168531) bytes
ProgBank_A/B	84K (84270) bytes
SingleProg	668 bytes
All_Multi	8K (7617) bytes
MultiBank_A/B	4K (3814) bytes
SingleMulti	248 bytes
All_Pattern	6K (5860) bytes
GLOBAL	483 bytes
MIDI	483 bytes
GLOBAL&MIDI	966 bytes

- ③ If required for the selected "Data Dump Source," specify the "Dump Destination."
- ④ Press the [ENTER] key, and a message of "Are you sure?" will appear. If you have changed your mind, press the [EXIT] key.
- ⑤ Press the [ENTER] key once again, and the data dump will be executed. When transmission is completed, the display will indicate "Completed." Press the [EXIT] key to return to the normal display.

 While a data dump is in progress, do not touch the Z1's switches.

 The edited data of the currently selected program or MultiSet will not be transmitted by this operation. Save this data as necessary.

□ Receiving MIDI system exclusive messages

1-5 SystemExclusive Receive [DIS, ENA]

This setting controls reception of system exclusive messages that are transmitted from an external MIDI device. If you wish to use an external device such as a computer to edit the Z1, set this to ENA (enable). With a setting of DIS (disable), incoming system exclusive messages will be ignored.

Data reception procedure

 When this operation is performed, internal data will be lost. Use a memory card or a data filter to backup important internal data before you perform this operation.

- ① Connect the external MIDI device's MIDI OUT to the Z1's MIDI IN.
- ② Turn OFF the memory protect setting for programs or arpeggio patterns (Global mode "Memory Protect").
- ③ Turn ENA system exclusive reception ("SystemExclusive Receive").
- ④ Set the transmission channel and the Z1's Global MIDI channel to matching settings. (When transmitting data that was saved on a data filter, select the Global MIDI channel that was used when saving the data.) Then transmit the data from the external MIDI device.

Settings that affect the entire Z1 (Global mode)

In this mode you can make various settings which affect the entire Z1.

 Settings made in this mode will be remembered without your having to execute the Write operation.

GLB Basic page

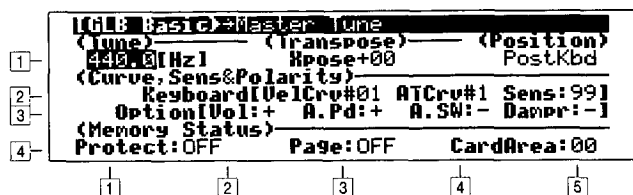

Adjust the tuning and transposition

1-1 Master Tune [430.0 Hz...450.0 Hz]

Adjust this parameter when you need to tune the Z1 to another instrument.

The overall pitch can be adjusted in 0.1 Hz steps.

This can be adjusted in the range of 430.0 Hz to 450.0 Hz around the standard pitch of A4 (=440 Hz).

When using the numeric keys to input this value, specify a value of -10.0 (Hz) to +10 (Hz) relative to 440 Hz.

1-3 Transpose [-12...+12]

Adjust this parameter when you wish to transpose the pitch of a song.

The pitch of the entire Z1 can be adjusted in steps of one semitone (100 cents). The range is one octave upward or downward.

Specify how transpose, velocity curve and aftertouch curve will be applied

1-5 Transpose Position [PostKbd, PreTG]

Specify the point at which transpose, velocity curve and aftertouch curve settings will be applied. This setting will affect the way in which MIDI data is handled. If you are using the Z1's own keyboard to play the internal tone generator, this setting will make no difference.

With a setting of **PostKbd**, the transpose, velocity curve and aftertouch curve settings will be applied immediately after the Z1's keyboard, so that the note numbers, velocity data and aftertouch data transmitted from the keyboard will be converted by the specified value or curve, and this converted data will play the Z1's tone generator and be transmitted from MIDI OUT. The transpose, velocity curve and aftertouch curve settings will not affect MIDI data that is received from MIDI IN.

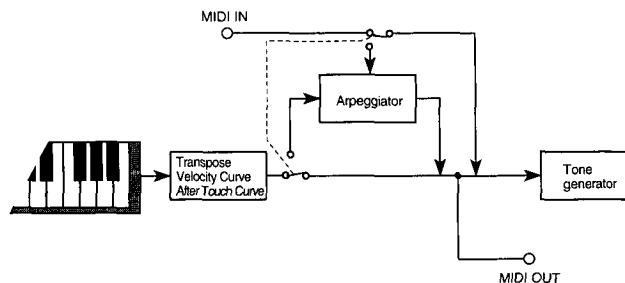

With a setting of **PreTG**, transpose, velocity curve and aftertouch curve settings will be applied immediately before the tone generator, so that the note numbers, velocity and aftertouch data being input to the tone generator will be converted by the specified value or curve before they are sounded. MIDI data transmitted from MIDI OUT will not be affected by transpose, velocity curve and aftertouch curve settings.

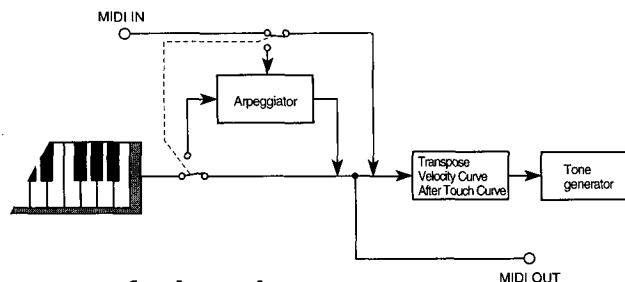

Specify the velocity curve

2-3 Velocity Curve [1...13]

Select one of eight curves to specify how changes in velocity (playing dynamics) will affect the volume or tone. This functioning of this parameter will be affected by the "Transpose Position."

1: Notes must be played strongly to create a significant change in velocity

2: :

3: :

4: Standard curve

5: :

6: Significant change in velocity will result even if you do not play strongly

7: Notes played with medium force will produce fairly consistent velocity with little change

8: Notes played with medium force will produce fairly consistent velocity with little change (flatter than 7)

9: Velocity value 64

10: Velocity value 80

11: Velocity value 100

12: Velocity value 115

13: Velocity value 127

Since curves 7 and 8 produce little change for notes played with medium force, they are suitable for situations in which you do not require velocity sensitivity or when you want the notes to sound evenly. However, control of softly-played notes will be more difficult, so use the curve that is appropriate for your needs.

With settings of 9 to 13, the same velocity value will be produced regardless of how strongly you play.

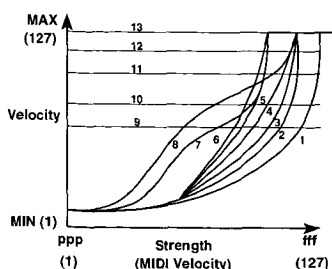

Specify the aftertouch curve and sensitivity

2-4 After Touch Curve [1...8]

Select one of eight curves to specify how aftertouch (pressure applied to the keyboard after playing a note) will affect the volume or tone. This functioning of this parameter will be affected by the "Transpose Position."

- 1: Significant effect will not occur unless you press strongly
- 2: :
- 3: Standard curve
- 4: :
- 5: An effect will be produced even with moderate pressure
- 6: Rough curve (24 steps)
- 7: Rougher curve (12 steps)
- 8: Random

Curves 6 and 7 produce change over 24 and 12 steps respectively. Since curve 7 produces a change over 12 steps, you can specify a pitch change width of 1 octave to be controlled by aftertouch, and use aftertouch to vary the pitch in semitone steps. Curve 8 is random. Use it for special effects, or to use aftertouch to create irregular modulation.

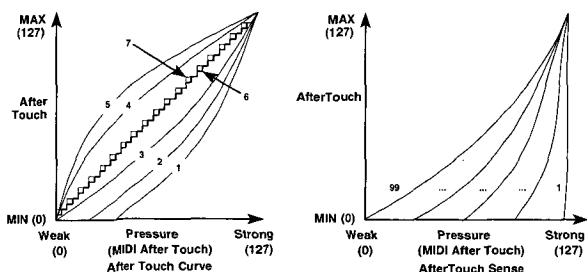

2-5 After Touch Sensitivity [0...99]

Specify the sensitivity of aftertouch. Raising the value will increase the sensitivity.

With a setting of 0, there will be no effect. This parameter will affect the selected aftertouch curve as shown in the above right diagram. The diagram shows the example of "After Touch Curve" 3.

Specify the polarity of the pedals connected to the rear panel

3-2 Volume Pedal Polarity [+,-]

Specify the polarity of the pedal connected to the VOLUME PEDAL jack.

3-3 Assignable Pedal Polarity [+,-]

Specify the polarity of the pedal connected to the ASSIGNABLE PEDAL jack.

3-4 Assignable SW Pedal Polarity [+,-]

Specify the polarity of the foot switch connected to the ASSIGNABLE SW PEDAL jack.

3-5 Damper Polarity [+,-]

Specify the polarity of the pedal connected to the DAMPER PEDAL jack.

Prohibit writing of internal programs and arpeggio patterns

4-1 Memory Protect [OFF, ON]

With a setting of ON, writing of internal programs and arpeggio patterns will be prohibited.

When you wish to write edited data or load factory preset data, or to receive a data dump, turn this OFF.

Using the page memory function

4-3 Page Memory [OFF, ON]

With a setting of ON, turning on the power will cause the Z1 to start up in basically the same state in which it was when the power was turned off. The corresponding Play mode will be selected, but the edited data or edit recall data, and the pages which were last-selected in each mode when the power was turned off will be remembered.

With a setting of OFF, turning on the power will cause program A000 and MultiSet A00 to be selected, and the Z1 will start up in Program Play mode.

To turn page memory ON:

- ① Press the [GLOBAL] key to enter Global mode.
- ② Press the [JUMP] key, and then press knob [1] (Basic) to select the GLB Basic page.
- ③ Press knob [3] several times to select "PageMemory."
- ④ Press the [+] key or rotate knob [3] toward the right to turn the setting ON.

Selecting the area of a memory card

4-5 Card Area Select [0...15]

Select the card area that you wish to use. Programs, MultiSets and arpeggio settings will be selected from and written to the area that you specify here.

The number of available areas (maximum 16) will depend on the capacity of the card (see p.110). If the selected area exceeds the capacity of the card, the display will indicate "No Card." Select a different card area.

Before a new memory card can be used, it must be formatted.

GLB User Group Name view page

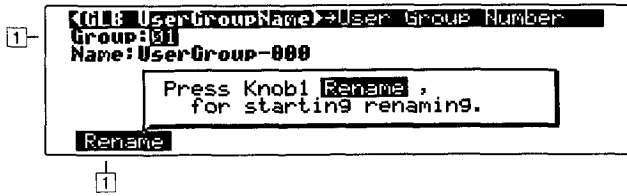

□ Modifying the name of each user group

1-1 User Group Number [1...16]

Select the user group whose name you wish to modify. User groups can be used as a method of classifying programs that is separate from program Categories.

Name Edit

Assign a name to the user group.

For details and the procedure, refer to "Modifying a name (Rename)" (p.25).

GLB User Scale page

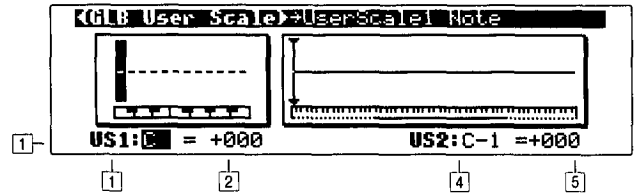

□ Creating an original scale

Here you can create two different original scales.

UserScale1 lets you create a scale by specifying the pitch of each note in an octave. Adjust the pitch of each note (C to B) in the octave in 1-cent steps, and these settings will be applied to all octaves.

UserScale2 lets you specify the pitch of each note (C-1 to G9) separately, in 1-cent steps.

For each note, the setting represents an adjustment of -100 to +100 cents (one semitone up or down) relative to the standard equal temperament (considered as 0). A setting of -100 lowers the pitch by one semitone, and a setting of +100 raises the pitch by one semitone.

The UserScale1 and UserScale2 that you create here will take effect for a program when they are selected for the Prg Common section "Scale Type" parameter, and for a MultiSet when they are selected for the Multi Common section "Scale Type" and Multi Pitch section "Scale" parameters.

1-1 UserScale1 Note [C...B]

Select the note of **UserScale1** that you wish to detune. The note can be selected either by rotating knob [1] or by using the [▼] or [▲] keys.

1-2 UserScale1 Detune [-100...+100]

Specify a detuning of -100 cents to +100 cents for the note selected in "UserScale1 Note."

1-4 UserScale2 Note [C-1...G9]

Select the note of **UserScale2** that you wish to detune. The note can be selected either by rotating knob [4] or by using the [▼] or [▲] keys.

1-5 UserScale2 Detune [-100...+100]

Specify a detuning of -100 cents to +100 cents for the note selected in "UserScale2 Note."

GLB Ctrl Setup page



❑ Changing the volume pedal function to an expression pedal

1-1 Volume Pedal Function [Volume, Express]

This parameter specifies the function of the pedal connected to the rear panel VOLUME PEDAL jack (see p.xiii).

With a setting of **Volume**, pedal movements will control the volume of the Z1. Simultaneously, MIDI Volume messages (CC#7) will be transmitted to regulate the volume of timbres on a matching MIDI channel.

With a setting of **Express**, pedal movements will control the volume of the Z1. Simultaneously, MIDI Expression messages (CC#11) will be transmitted to regulate the volume of timbres on a matching MIDI channel.

❑ Synchronizing with digital audio devices

1-5 Word Clock Source [INT, EXT]

This parameter will be displayed if an optional <DI-TRI digital I/F board (sold separately)> is installed (see p.109).

Specify the master clock which will determine the sampling frequency.

With a setting of **INT**, the Z1 will use its own internal clock. You will normally select this setting.

With a setting of **EXT**, the Z1 will use the external digital I/F clock that it receives from the WORD CLOCK IN jack.

❑ Calibrating the various controllers

2-1 Calibration Item [P.Bender ... AssignPdl]

Here you can adjust (calibrate) the effective range of each controller. If the effect specified by the parameter settings is not fully produced when you move a controller to its maximum or minimum position, or if the maximum or minimum effect is reached while you are still moving the controller, you will need to perform the calibration for that controller.

P.Bender Adjust the effective range of movement and the width of the center for the [PITCH BENDER].

Mod.Wheel Adjust the effective range of [MOD WHEEL] movement away from yourself and toward yourself.

Pad_X Adjust the effective range of movement and the width of the center for the X-axis of the [X-Y PAD].

Pad_Y Adjust the effective range of movement and the width of the center for the Y-axis of the [X-Y PAD].

AftTouch Adjust the effective range of the aftertouch that is applied by pressing on the keyboard.

VolumePdl Adjust the effective range of the foot pedal connected to the VOLUME PEDAL jack.

AssignPdl Adjust the effective range of the foot pedal connected to the ASSIGNABLE PEDAL jack.

 While this parameter is selected (i.e., while calibration is being performed), all controllers will temporarily revert to an uncalibrated state. In order to check the results of this operation, you must either continue to the end of the operation, or halt the operation by moving the cursor (up or down) or moving to a different page.

Calibration procedure

① For the "Calibration" setting, specify the controller whose effective range you wish to adjust.

② Move the specified controller until it stops (or to the edge of the [X-Y PAD]), to store the maximum valid range of the controller. The black area of the meter in the right of the LCD will indicate the area of movement. In this case, more space has been allowed for the length of the meter than will normally be used, so it is not a problem if the black area does not extend all the way to both edges.

③ Release your hand from the controller, and press the [ENTER] key. A message of "Are you sure?" will ask for confirmation.

 Be aware that if the [Pitch Bender] has not returned to the middle, or if some point on the [X-Y PAD] is being pressed, that point will be detected as the center.

④ If this setting is satisfactory, press the [ENTER] key once again. To re-do the setting, press the [EXIT] key.

When the setting is completed, the display will indicate "Completed!" if **Mod.Wheel**, **AftTouch**, **Volume Pdl** or **AssignPdl** was selected in ①, and the effect of the controller will reach the maximum and minimum positions at the specified locations.

If **P.Bender**, **Pad_X** or **Pad_Y** was selected, the display will indicate "Set CENTER." The black area which indicated the valid range will shrink, and you can now adjust the center setting. Continue the procedure from step ⑤.

 If the setting was inappropriate, such as an abnormally narrow valid range of movement, the display will indicate "!Value Mismatch!," and the procedure will be aborted. Press the [EXIT] key and try the procedure again from step ②.

Adjusting the center of the P.Bender, Pad_X or Pad_Y

⑤ Next, the width of the "null" in the middle of the [PITCH BENDER] or the [X-Y PAD] will be stored. In the case of the [PITCH BENDER], move the wheel lightly. In the case of the [X-Y PAD], press the center of the pad. The width of the detected null will be displayed below the black area that shrunk in the previous step.

- ⑥ Press the [ENTER] key. A message of <Are you sure?> will appear. If you decide to re-do the settings, press the [EXIT] key to return to step ⑤.
- ⑦ Press the [ENTER] key once again. The display will indicate <Completed!>, and the displayed settings will be finalized.

 If the central "null" area is inappropriate, the display will indicate <!Value Mismatch!>, and the procedure will be aborted. Press the [EXIT] key and try the procedure again from step ⑤.

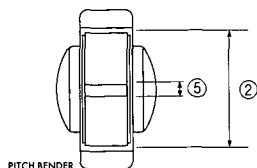

Linking the arpeggiator to programs or MultiSets

3-1 AutoArpeggiator Program [OFF, ON]

This setting links the arpeggiator function to program (number) selection.

When a program is saved, it also saves the state of the arpeggiator at that time. If the arpeggiator was turned on when a program was saved, the previous state of the arpeggiator will be recalled automatically when that program is recalled if AutoArpeggiator Program is ON. If this parameter is OFF, the state of the arpeggiator at the time which the program was saved will be ignored.

3-2 AutoArpeggiator MultiSet [OFF, ON]

This setting links the arpeggiator function to MultiSet (number) selection. Refer to "AutoArpeggiator Program."

Bypassing the master effect

3-4 Master Effect [AVAIL, BYPASS]

With a setting of AVAIL, the master effect will function according to the program or MultiSet settings. With a setting of BYPASS, the master effect will be bypassed. Use this setting when you wish to use external processing units to apply effects.

The output configuration from stereo to mono

3-5 Output Mode [STEREO, MONO]

If you have connected both the L/MONO and R OUTPUT jacks, set this to STEREO.

If you have connected only the L/MONO jack, set this to MONO. With a setting of MONO, the "Panpot" settings of a program and of each timbre in a MultiSet will be ignored. If you set this to STEREO when only the L/MONO jack is connected, problems such as "no effect sound" or "lowered volume" may occur for some programs.

GLB Data Utility page

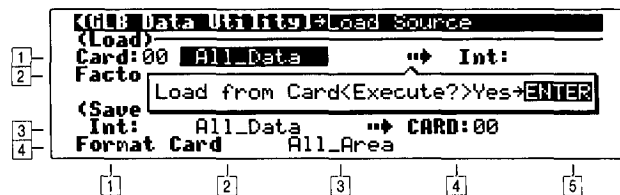

Loading data from a memory card

Z1 data such as programs, MultiSets, arpeggio patterns etc. stored on a memory card (sold separately) can be loaded into internal memory.

1-1 Target Card Area [0...15]

Select the card area from which the data will be loaded. At the time that this page is opened, the area currently selected by "Card Area Select" (see p.91) will be selected.

 The number of available areas (maximum 16) will depend on the capacity of the card (see p.110). If the selected area exceeds the capacity of the card, the display will indicate "No Card." Make sure of the desired card area, and select a different "Target Card Area."

Also, a new memory card must be formatted before it can be used.

1-2 Load Source [All_Data...GLOBAL&MIDI]

Select one of the following types of data to be loaded from the memory card.

- 0: All_Data: All data (the following items 1 to 10)
- 1: All_Program: All programs
- 2: ProgBank_A: All programs of program bank A
- 3: ProgBank_B: All programs of program bank B
- 4: All_Multi: All MultiSets
- 5: MultiBank_A: All MultiSets of MultiSet bank A
- 6: MultiBank_B: All MultiSets of MultiSet bank B
- 7: All_Pattern: All arpeggio patterns
- 8: GLOBAL: Global mode data
- 9: MIDI: MIDI mode data
- 10: GLOBAL&MIDI: Global mode and MIDI mode data

1-5 Load Destination [BANK_A, BANK_B]

This parameter will appear if either 2, 3, 5, or 6 was selected as "Load Source."

Specify the loading destination in internal memory.

Loading procedure

 When this procedure is performed, data will be lost from internal memory. The current memory data will not be affected. If internal memory contains data that you wish to keep, you will need to save it to a memory card or a data filer etc. before you execute this procedure.

- ① Insert a memory card which has been formatted for the Z1 and which contains the desired data into the rear panel CARD connector.
- ② Turn OFF memory protection for programs and arpeggio patterns (Global mode "Memory Protect").
- ③ Specify the "Target CardArea", "Load Source" and "Load Destination."
- ④ Press the [ENTER] key, and the display will ask you <Are you sure?> If you decide to change the specified settings, press the [EXIT] key.
- ⑤ Press the [ENTER] key once again, and the operation will be executed.

❑ Loading the factory preset data into internal memory

2-2 Load Source [All_Data...Init_All]

The following factory preset data can be loaded.

0: All_Data:	All factory data (the following items 1 to 12)
1: All_Program:	All programs
2: ProgBank_A:	All programs of program bank A
3: ProgBank_B:	All programs of program bank B
4: SingleProg:	A specified program
5: All_Multi:	All MultiSets
6: MultiBank_A:	All MultiSets of MultiSet bank A
7: MultiBank_B:	All MultiSets of MultiSet bank B
8: SingleMulti:	A specified MultiSet
9: All_Pattern:	All arpeggio patterns
10: GLOBAL:	Global mode data
11: MIDI:	MIDI mode data
12: GLOBAL&MIDI:	Global mode and MIDI mode data
13: Init_All:	All data will be initialized to the factory settings

2-3 Load Source Number [A0...B127/A0...B15]

This parameter will appear if 4 or 8 was selected for "Load Source."

Specify the number of the factory preset data which will be loaded.

2-5 Load Destination ... [A0...B127/A0...B15/BANK_A,BANK_B]

This parameter will appear if 2, 3, 4, 6, 7 or 8 was selected for "Load Source."

Specify the bank or number of the loading destination. For details on the loading procedure, refer to p.94.

❑ Saving internal memory data to a memory card

3-2 Save Source [All_Data...GLOBAL&MIDI]

Specify the internal data that will be saved to memory card.

For details on this parameter, refer to "1-2 Load Source."

 If the memory card which you are using is a Flash EPROM type device, only All_Data can be selected.

3-4 Target Card Area [0...15]

Select the card area to which the data will be saved.

3-5 Save Destination [BANK_A, BANK_B]

This parameter will appear if 2, 3, 5 or 6 was selected for "Save Source."

Specify the save destination bank of the memory card.

Saving procedure

- ① Make sure that the memory card has been formatted for the Z1 and contains the area into which you wish to save the data, and insert the card into the rear panel CARD connector.
- ② Specify the "Target CardArea", "Save Source" and "Save Destination."
- ③ Press the [ENTER] key and a message will ask you <Are you sure?> If you decide to change your settings, press the [EXIT] key.
- ④ Press the [ENTER] key once again to execute the operation.

4-3 Target Card Area [Area_00...15, All_Area]

This operation formats a memory card.

Before a new memory card can be used with the Z1, the card must be formatted (initialized). This operation can also be used to re-format a previously-used card, to erase unwanted data.

You may format an individual area, or all areas at once.

Procedure for formatting a memory card

- ① Insert the memory card to be formatted into the rear panel CARD connector.
- ② Specify the "Target Card Area."
Immediately after this page is selected, All_Area will be selected automatically. If you wish to format only a specific area, select the desired area.
- ③ Press the [ENTER] key, and you will be asked for confirmation with a message of <Are you sure?> If you have changed your mind, press the [EXIT] key.
- ④ If you press the [ENTER] key once again, the format operation will be executed.
When the format operation is executed, initialized program, MultiSet and pattern data will be created in the formatted area. (This data will be the same as that created by the initialize operation in the corresponding Play mode.) If you re-format an area which has already been formatted, be aware that all previous data in that area will be lost.

 While a memory card operation is being performed, do not allow physical shock to be applied to the Z1, or insert or remove the card. Also, you must not perform an operation such as receiving a MIDI data dump, etc. Doing any of these things may cause data to be lost.

Appendices

1. About MIDI

MIDI stands for Musical Instrument Digital Interface, and is a world-wide standard that allows electronic musical instruments and computers etc. to exchange a variety of musical data.

When two or more MIDI devices are connected via a MIDI cable, they can exchange musical performance data even if the devices are different models or were even made by different manufacturers. For example you can use the Z1 as a master keyboard to control an external MIDI device, or use an external MIDI device to control the tone generator of the Z1.

□ Connections between MIDI devices

Playing an external MIDI device

- ✦ If you wish to use the keyboard and controllers of the Z1 to play an external MIDI tone generator, use a MIDI cable to connect the Z1's MIDI OUT to the external MIDI device's MIDI IN.

Playing the Z1's tone generator from an external MIDI device

- ✦ If you wish to control the Z1 from an external MIDI device such as another MIDI keyboard, use a MIDI cable to connect the MIDI OUT of the external MIDI device to the MIDI IN of the Z1.

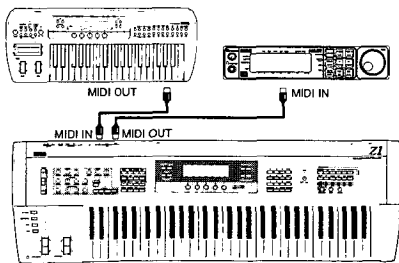

Connections with a computer/sequencer

- ✦ If you wish to play the Z1's keyboard and record your performance on a computer or sequencer, and then playback the sound on the Z1 (i.e., to use the Z1 as a MIDI keyboard for inputting as well as the MIDI tone generator for playback), connect the MIDI OUT and MIDI IN connectors of each device to those of the other.

✦ In order to connect a computer, you will need a MIDI interface.

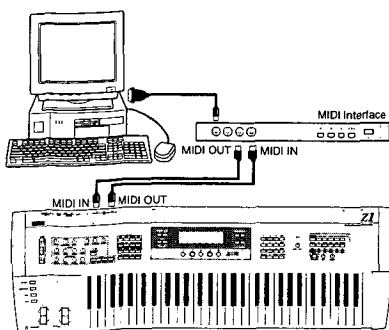

□ MIDI channel settings

In order for MIDI messages to be received, the MIDI channel of the receiving device must match the MIDI channel of the transmitting device. There are sixteen MIDI channels: 1 to 16.

When you operate the keyboard (or arpeggiator) and controllers of the Z1, MIDI messages are transmitted from MIDI OUT on the Global MIDI channel (the "G.Ch" setting made in the MIDI Mode MIDI Basic page). In Program Play mode, musical data is received on the Global MIDI channel. In MultiSet Play mode, data is received by each timbre on the channel specified by the MultiSet Edit mode MLT MIDI page "MIDI Channel" parameter.

Using the Z1 as a multi-timbral tone generator

By making the above MIDI channel settings for a MultiSet, you can specify a separate MIDI receive channel for each timbre so that the Z1 will function as a multi-timbral tone generator with up to six parts.

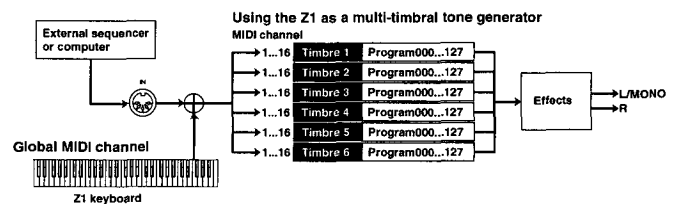

□ Using the Z1 as a MIDI keyboard for input

If you wish to use the Z1 as a MIDI keyboard for inputting musical data, you will in most cases wish to turn on the Echo Back setting of your sequencer, so that you can listen to the performance that you are inputting. In this case the notes sent from the keyboard → tone generator will sound in duplicate with the notes that are sent from the keyboard → sequencer → tone generator, so you will need to turn the MIDI mode "Local (Local Control)" setting OFF to internally disconnect the Z1's keyboard from its tone generator. You can also transmit a Local Off message (control #122) from your sequencer to turn Local OFF.

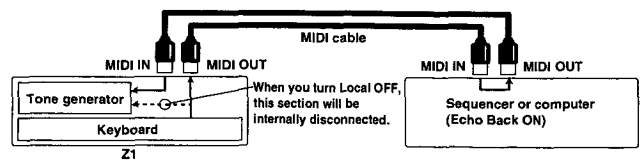

✦ If the Local parameter is turned OFF, the Z1's keyboard will not produce sound. (Data from the keyboard will be sent to MIDI OUT, and the tone generator will sound only in response to data received at MIDI IN.) If you are playing the Z1 by itself, be sure that Local is ON.

□ About the Transpose and Velocity Curve settings

You can specify the point at which the transposition ("Transpose") and velocity curve ("Velocity Curve") settings for the entire Z1 will be applied. The note numbers and velocity values will differ depending on the point at which they are converted. This setting is made by the Global mode "Transposition" parameter (see p.90). For a MultiSet, you can transpose each individual timbre ("Xpose") in addition to the Global mode setting.

□ MIDI filtering and message conversion

You can specify whether or not various types of MIDI messages will be received and transmitted. In the MIDI mode MIDI CChg Filter page, you can make settings for pitch bender, after touch, and control change messages. For a MultiSet, you can in addition make settings to specify whether each timbre will receive and transmit each of the above messages. In addition, the MIDI mode MIDI CChg Filter page "Translation" parameter lets you convert a specific MIDI message into a different message for reception or transmission.

The MIDI mode System EX page lets you enable or disable transmission/reception of the data dumps which occur when parameters are edited or programs are changed, and of other system exclusive data and messages. (A data dump can always be transmitted using <Data Dump Utility>, regardless of this setting.)

For MIDI filtering of program changes, refer to the explanation below.

□ Selecting sounds (programs or MultiSets)

Program Change messages [Cn, pp] (where "pp" is a program number which specifies one of 128 sounds) allow you to switch sounds from an external MIDI device. The Z1 transmits and receives these messages only when it is in Program Play mode or MultiSet Play mode. When a program change is received, a sound (program or MultiSet) of the current bank will be selected.

If you wish to switch the bank (program / MultiSet), you can use Bank Select messages [Bn, 00, mm] (control change #00) and [Bn, 20, bb] (control change #32) to specify the desired bank. ("mm" specifies the upper byte of the bank number and "bb" specifies the lower byte, allowing you to select from 16,384 banks.) However a bank select message alone will not cause the bank to be switched; a program will be selected from the new bank only when a program change is received after the bank select message.

Normally, you will set the Z1 to **Omni OFF** (see p.86) so that only those program changes which match the Global MIDI channel will be received to select programs.

The MIDI mode MIDI Basic page "Program Change" parameter lets you can specify whether or not program changes will be transmitted and received. Programs can be selected in Program Play mode if "Program Change Receive" is set either to **ENA** or **PRG**. In MultiSet Play mode, the MultiSet Edit mode Multi MIDI section "Prog.Change" settings are also used. However when the MIDI mode "Program Change Receive" setting is **ENA**, and a program change which matches the "Global Channel" is received, the MultiSet number will change (regardless of the "Prog.Change" setting). With a setting of **PRG**, the MultiSet number will not change, but a program will be selected for the timbre that is receiving that channel.

The Z1 allows you to freely specify the correspondence between sounds (programs / MultiSets) and the program numbers and program banks of an external MIDI device. The MIDI mode MIDI Basic page "Bank Mapping" setting allows you to specify the bank select setting, and the MIDI Prog Map page and MIDI Multi Map page allow you to specify the program change setting.

The factory settings are as follows.

[Prog]	MSB	LSB
Int_A	00 (00H)	00 (00H)
Int_B	00 (00H)	01 (01H)
CardA	00 (00H)	02 (02H)
CardB	00 (00H)	03 (03H)
[MultiSet]	MSB	LSB
Int_A	00 (00H)	64(40H)
Int_B	00 (00H)	65 (41H)
CardA	00 (00H)	66 (42H)
CardB	00 (00H)	67(43H)

Example: With the factory settings, selecting Program Play mode internal bank B21

```
MSB CC#: 0)    00
LSB (CC#: 32) 01
Program Change: 21
```



Depending on the oscillator type that is used by a program or MultiSet, an interval of time may be required for the Z1's program to change after receiving the program change message. When changing programs, allow a sufficient interval between the program change message and the note-on message which follows.

□ MIDI messages which the Z1 transmits

Unless otherwise specified, this section will explain only transmission. ("CC#" is the control change number, "vv" is the value.)

Note-on/off

When a key is pressed, a note-on message [9n, kk, vv] (n: channel, kk: note number, vv: velocity) is transmitted to indicate the key which was pressed (note number) and the force with which it was pressed (velocity). When a key is released, a note-off message [8n, kk, vv] is transmitted.

Each time a note is played on the Z1's keyboard, note-on/off messages are transmitted on the Global MIDI channel. However note-on/off messages are received on all MIDI channels if **Omni** is **ON**. Normally you will turn **Omni OFF** (MIDI mode MIDI Basic page "Omni") so that only those note-on/off messages which match the Global MIDI channel will be received.

Aftertouch *1

Aftertouch is the function which allows the sound to be modified by applying pressure to the keyboard after playing a note. This is transmitted by a Channel Pressure message [Dn, vv]. When this message is received, the aftertouch effect will be applied.

There is also another type of aftertouch message called Polyphonic Key Pressure which allows an effect to be applied separately to each key. The Z1 does not use this message, so all references to "aftertouch" in this manual refer to Channel Pressure (which affects all notes regardless of the area of the keyboard to which pressure was applied).

Pitch bender *1

By operating the [PITCH BENDER] of the Z1 you can produce pitch bending effects. At the same time, pitch bend messages [En, bb, mm] are transmitted. (bb: lower byte of the value, mm: upper value of the byte, in combination allowing 16384 steps to be expressed, with 8192 [bb, mm = 00, 40] being the central value.)

Bank select (CC#0 / CC#32)

Refer to "Selecting sounds (programs or MultiSets)."

Pitch modulation (CC#01) *1

Operating the Z1's [MOD WHEEL] will normally produce a vibrato effect. At the same time, pitch modulation depth messages [Bn, 01, vv] (CC #01) will be transmitted.

MIDI Breath Control (CC#02) *1

When the function of a pedal connected to the Z1's ASSIGNABLE PEDAL jack is set to **MIDI_BC** by either the program (Prg Common section) or MultiSet (Multi CMN SW & Pdl section) parameter "Assignable Pedal Function," operating the pedal will produce the tonal change that is controlled by the breath controller, and a message of [Bn, 02, vv] (CC #02) will be transmitted.

Foot Pedal (CC#04) *1

The function of a pedal connected to the Z1's ASSIGNABLE PEDAL jack can be specified by the program (Prg Common section) or MultiSet (Multi CMN SW & Pdl section) parameter "Assignable Pedal Function" as **FootPdl**, so that when the pedal is operated, a parameter whose modulation source has been set to **FootPdl** will be modified to affect the sound, etc. At the same time, a message of [Bn, 04, vv] (CC #04) will be transmitted.

Portamento time (CC#05) *1

When MIDI Portamento Time messages [Bn, 05, vv] (CC #05) are received, the speed at which portamento occurs will change. This has an effect only if the portamento switch is on.

Data entry (MSB) (CC#06/CC#38)

This message is used to set RPN or NRPN values.

MIDI Volume (CC#07) *1

When the function of a pedal connected to the Z1's VOLUME PEDAL jack is set to **Volume** (Global mode "Volume Pedal Function"), operating the pedal will adjust the overall volume of the program or MultiSet (or an individual timbre, except for the Global MIDI channel). At the same time, Volume messages [Bn, 07, vv] (CC # 07) will be transmitted.

The function of a pedal connected to the Z1's ASSIGNABLE PEDAL jack can be set to **MIDI_Vol** by the "Assignable Pedal Function" parameter of a program (Prg Common section) or MultiSet (Multi CMN SW & Pdl section), so that operating the pedal will have the same result as operating the VOLUME PEDAL with a setting of **Volume**.

MIDI Panpot (CC#10) *1

When listening in stereo, this specifies the location (stereo position) from which the sound of that channel will be heard. This can be controlled by MIDI Panpot messages [Bn, 0A, vv] (CC #10).

MIDI Expression (CC#11) *1

When the function of a pedal connected to the Z1's VOLUME PEDAL jack is set to **Express** by the Global mode "Volume Pedal Function" parameter, operating the pedal will adjust the volume of the entire program or the volume of an individual timbre in the MultiSet. At the same time, Expression messages [Bn, 0B, vv] (CC #11) will be transmitted.

The function of a pedal connected to the Z1's ASSIGNABLE PEDAL jack can be set to **MIDI_Exp** by the "Assignable Pedal Function" parameter of a program (Prg Common section) or MultiSet (Multi CMN SW & Pdl section), so that operating the pedal will have the same result as operating the VOLUME PEDAL with a setting of **Express**.

PAD X (CC#16) *1

When you operate the Z1's [X-Y PAD] in the X-axis, the parameter whose modulation source is set to **X[+/-]**, **X[+]** or **X[-]** will modify the sound. At the same time, a message of [Bn, 10, vv] (CC #16) will be transmitted.

PAD Y (CC#17) *1

When you operate the Z1's [X-Y PAD] in the Y-axis, the parameter whose modulation source is set to **Y[+/-]**, **Y[+]** or **Y[-]** will modify the sound. At the same time, a message of [Bn, 11, vv] (CC #17) will be transmitted.

Knob 1, 2, 3, 4, 5 (CC#19, 20, 21, 22, 23) *1

When you operate one of the Z1's knobs [1] to [5], the sound will change as specified by the parameters whose modulation sources have been assigned to **knob1** to **knob5**. At the same time, the following control changes will be transmitted.

knob1: [Bn, 13, vv] (CC #19)
knob2: [Bn, 14, vv] (CC #20)
knob3: [Bn, 15, vv] (CC #21)
knob4: [Bn, 16, vv] (CC #22)
knob5: [Bn, 17, vv] (CC #23)

Damper (CC#64) *1

When a pedal connected to the Z1's DAMPER jack is operated, the damper effect will be controlled. At the same time, a Hold message [Bn, 40, vv] (CC #64: "vv"= 127 [7F] when on, or 00 when off) will be transmitted. The function will be OFF if the value "vv" is 63 [3F] or less, and ON if it is 64 [40] or more.

When a pedal connected to the Z1's DAMPER jack is pressed, the damper effect will be applied. At the same time, a Hold message [Bn, 40, vv] (CC # 64, vv=127 [7F] when ON, or 00 when OFF) will be transmitted.

The function of a pedal connected to the Z1's ASSIGNABLE SW jack can be set to **Damper** by the "Assignable Pedal Function" parameter of a program (Prg Common section) or MultiSet (Multi CMN SW & Pdl section), so that operating that pedal will have the same result as operating the pedal that is connected to the DAMPER jack.

Portamento SW (CC#65) *1

When the Z1's [PORTAMENTO] key is turned on, the portamento effect will be applied. At the same time, a Portamento Switch message [Bn, 41, vv] (CC #65: "vv"= 127 [7F] when ON, or 00 when OFF) will be transmitted. The function will be OFF if the value "vv" is 63 [3F] or less, and ON if it is 64 [40] or more.

Sostenuto (CC#66) *1

When the function of a pedal connected to the Z1's ASSIGNABLE SW jack is set to Sostenuto by either the program (Prg Common section) or MultiSet (Multi CMN SW & Pdl section) parameter "Assignable Pedal Function," operating the pedal will apply the sostenuto effect (where only those notes which were already pressed when the pedal was pressed will be held). Simultaneously, a message of [Bn, 42, vv] (CC #66) (vv: 00→OFF, 7F→ON) will be transmitted.

Mod.SW1 (CC#80) *1

Mod.SW2 (CC#81) *1

If you set the "SW1 Function" "SW2 Function" parameters of a program (Prg Common section) or MultiSet (Multi CMN SW & Pdl section) to **Mod.SW1** and **Mod.SW2**, you can operate the [SW1] and [SW2] keys to modify the sound by controlling the parameters whose modulation sources are set to **Mod.SW1** and **Mod.SW2**. At the same time, messages of [Bn, 50, vv] (CC #80) and [Bn, 51, vv] (CC #81) will be transmitted.

Foot SW (CC#82) *1

If you set the "Assignable Pedal Function" parameter of a program (Prg Common section) or MultiSet (Multi CMN SW & Pdl section) to **FootSW**, a pedal connected to the Z1's ASSIGNABLE SW jack can operated to modify the sound by controlling the parameter whose modulation source is set to **FootSW**. At the same time, a message of [Bn, 52, vv] (CC #82) will be transmitted.

Arpeggio Resolution Knob (CC#09) *1

When you operate the Z1's [RESOLUTION] knob, the resolution of the arpeggio notes will change. At the same time, a message of [Bn, 09, vv] (CC #9) will be transmitted. The setting will be ♩₃ for a "vv" value of 0 [0] to 21 [15], ♪ for a value of 22 [16] to 42 [2A], ♩₃ for a value of 43 [2B] to 63 [3F], ♪ for a value of 64 [40] to 84 [54], ♩₃ for a value of 85 [55] to 105 [69], and ♩ for a value of 106 [6A] to 127 [7F].

Arpeggio Gate Knob (CC#14) *1

When you operate the Z1's [GATE] knob, the duration (Gate time) of the arpeggio notes will change. At the same time, a message of [Bn, 0E, vv] (CC #14) will be transmitted.

Arpeggio Velocity Knob (CC#15) *1

When you operate the Z1's [VELOCITY] knob, the velocity of the arpeggio notes will change. At the same time, a message of [Bn, 0F, vv] (CC #15) will be transmitted.

Filter1 Cutoff Knob (CC#85) *1

When you operate FILTER1 [CUTOFF], the cutoff frequency will change to modify the brightness of the sound. At the same time, a message of [Bn, 55, vv] (CC #85) will be transmitted.

Filter1 Resonance Knob (CC#86) *1

When you operate FILTER1 [RESONANCE], the amount of resonance will change. At the same time, a message of [Bn, 56, vv] (CC #86) will be transmitted.

Filter1 EG Intensity Knob (CC#87) *1

When you operate FILTER1 [EG INT.], the "Cutoff Frequency Mod. EG Intensity" of filter 1 will change. At the same time, a message of [Bn, 57, vv] (CC #87) will be transmitted.

Filter1 Attack Knob (CC#24) *1

If [FILTER SELECT] key 1 or 1&2 is selected, operating FILTER EG [ATTACK] will modify the way in which the tone changes when filter 1 rises. At the same time, a message of [Bn, 18, vv] (CC #24) will be transmitted.

Filter1 Decay Knob (CC#25) *1

If [FILTER SELECT] key 1 or 1&2 is selected, operating FILTER EG [DECAY] will modify the way in which the tone changes when filter 1 falls. At the same time, a message of [Bn, 19, vv] (CC #25) will be transmitted.

Filter1 Sustain Knob (CC#26) *1

If [FILTER SELECT] key 1 or 1&2 is selected, operating FILTER EG [SUSTAIN] will modify the way in which the tone changes when filter 1 reaches the sustain level. At the same time, a message of [Bn, 1A, vv] (CC #26) will be transmitted.

Filter1 Release Knob (CC#27) *1

If [FILTER SELECT] key 1 or 1&2 is selected, operating FILTER EG [RELEASE] will modify the way in which the tone changes when filter 1 falls from the sustain level. At the same time, a message of [Bn, 1B, vv] (CC #27) will be transmitted.

Filter2 Cutoff Knob (CC#88) *1

Refer to Filter1 Fc. A message of [Bn, 58, vv] (CC #88) will be transmitted.

Filter2 Resonance Knob (CC#89) *1

Refer to Filter1 Reso. A message of [Bn, 59, vv] (CC #89) will be transmitted.

Filter2 EG Intensity Knob (CC#90) *1

Refer to Filter1 EG Int. A message of [Bn, 5A, vv] (CC #90) will be transmitted.

Filter2 Attack Knob (CC#28) *1

If [FILTER SELECT] key 2 or 1&2 is selected, operating FILTER EG [ATTACK] will modify the way in which the tone changes when filter 2 rises. At the same time, a message of [Bn, 1C, vv] (CC #28) will be transmitted.

Filter2 Decay Knob (CC#29) *1

If [FILTER SELECT] key 2 or 1&2 is selected, operating FILTER EG [DECAY] will modify the way in which the tone changes when filter 2 falls. At the same time, a message of [Bn, 1D, vv] (CC #29) will be transmitted.

Filter2 Sustain Knob (CC#30) *1

If [FILTER SELECT] key 2 or 1&2 is selected, operating FILTER EG [SUSTAIN] will modify the way in which the tone changes when filter 2 reaches the sustain level. At the same time, a message of [Bn, 1E, vv] (CC #30) will be transmitted.

Filter2 Release Knob (CC#31) ¹

If [FILTER SELECT] key 2 or 1&2 is selected, operating FILTER EG [RELEASE] will modify the way in which the tone changes when filter 2 falls from the sustain level. At the same time, a message of [Bn, 1F, vv] (CC #31) will be transmitted.

Amp Attack Knob (CC#76) ¹

When you operate [ATTACK], the attack volume will change. At the same time, a message of [Bn, 4C, vv] (CC #76) will be transmitted.

Amp Decay Knob (CC#77) ¹

When you operate [DECAY], the decay volume will change. At the same time, a message of [Bn, 4D, vv] (CC #77) will be transmitted.

Amp Sustain Knob (CC#78) ¹

When you operate [SUSTAIN], the sustain level will change. At the same time, a message of [Bn, 4E, vv] (CC #78) will be transmitted.

Amp Release Knob (CC#79) ¹

When you operate [RELEASE], the note-off volume will change. At the same time, a message of [Bn, 4F, vv] (CC #79) will be transmitted.

Mixer Output SW (CC#83) ¹

MIXER SW operations will transmit a message of [Bn, 53, vv] (CC#83). Starting from the lowest bit of the 7-bit value "vv," each bit indicates the status of the OSC1/OSC2/SubOSC/NOISE switches respectively, where a bit of 1 is ON and 0 is OFF.

Mst. Fx ON/OFF (CC#92) ¹**Fx1 ON/OFF (CC#94) ¹****Fx2 ON/OFF (CC#95) ¹**

If you set the "Assignable Pedal Function" parameters of a program (Prg Common section) or MultiSet (Multi CMN SW & Pdl section) to M.Fx_SW, Fx1_SW or Fx2_SW, you can operate the [SW1] and [SW2] keys to switch the master effect, Fx1 or Fx2 on/off. At the same time, messages of [Bn, 5C, vv] (CC #92), [Bn, 5E, vv] (CC #94), or [Bn, 5F, vv] (CC #95) will be transmitted.

Fx Send (CC#91)

This specifies the output level to Fx1 and Fx2. This is controlled with a message of [Bn, 5B, vv] (CC#91).

MONO ON/OFF [CC#18] ¹

When the function of the [SW1] key, [SW2] key, or the ASSIGNABLE SW is set to MONO_SW by either the program (Prg Common section) or MultiSet (Multi CMN SW & Pdl section) parameter "Assignable SW Function," if the "Voice Assign Mode" is POLY, a message of [Bn, 12, vv] (CC#18) will be transmitted whenever you switch to monophonic note assignment (MONO 1).

UNISON ON/OFF (CC#75) ¹

When the function of the [SW1] key, [SW2] key, or the ASSIGNABLE SW is set to UNISON by either the program (Prg Common section) or MultiSet (Multi CMN SW & Pdl section) parameter "Assignable SW Function," a message of [Bn, 4B, vv] (CC#75) will be transmitted whenever you switch the "Unison SW" in any mode.

Data increment / decrement (CC#96/CC#97) ¹

The Data Increment message is used in the same way as control changes #6/#38 (Data Entry), but only to increase the data value by one unit. Data Decrement is the opposite of Data Increment, and decreases the data value by one unit.

NRPN (CC#98/CC#99)

NRPN (non-registered parameter number) messages are used to set sound parameters.

All Sound Off (CC#120)

This message allows all sounds to be halted from an external device. When an All Sound Off message [Bn, 78, 00] (CC #120) is received, all sound will stop. While the All Note Off message allows the decay of the currently-sounding notes to continue, All Sound Off will silence the notes immediately.

This message is provided for emergency use, and is not something that should be used during a performance.

Reset All Controllers (CC#121)

This message resets all controllers of the specified channel. When a Reset All Controllers message [Bn, 79, 00] (CC #121) is received, all controllers will be reset.

This message is provided for emergency use, and is not something that should be used during a performance.

All Note Off (CC#123)

This message allows all sounds to be halted from an external device. When an All Note Off message [Bn, 7B, 00] (CC #123) message is received, all notes will be set to a key-off status.

This message is provided for emergency use, and is not something that should be used during a performance.

Active Sensing

If for some reason the sound does not stop, you can reselect the program to turn off the "stuck" notes.

If the Z1 is receiving MIDI messages from an external MIDI device which transmits active sensing [FE] messages, the sound will automatically be turned off if for some reason messages stop coming for longer than a certain interval of time.

MIDI system exclusive

System exclusive messages are a special category of MIDI messages that are used to convey information that is unique to a manufacturer or model. The Z1's system exclusive messages follow a format of [F0, 42, 3n, 41, ff, ..., F7] (n: Global MIDI Channel, ff: function code). These messages make possible the functionality that is described in "Transmitting settings such as sound data (About data dump)" and "Editing sounds etc."

Some system exclusive messages have been assigned common functions which are not dependent on manufacturer or model. These messages are called Universal System Exclusive messages.

The Z1 uses the following universal system exclusive messages.

When it receives an Inquiry Message Request [F0, 7E, nn, 06, 01, F7] (nn: MIDI channel), it will respond with an inquiry message of [F0, 7E, nn, 06, 02, (9 bytes), 7F] which means "Korg, Z1, system version xxxx."

*1 This message is affected by the settings of the MIDI mode MIDI CChg Filter page, and for MultiSets is also affected by the settings of MultiSet Edit mode Mlt Ctl section. Refer to "MIDI filtering and message conversion."

□ Transmitting settings such as sound data (About data dump)

Data such as programs, MultiSets, arpeggio patterns, and MIDI and Global mode settings can be transmitted as MIDI exclusive data to an external device.

Transmission is performed in the MIDI mode MIDI SystemEX page. You can specify the type of data which will be transmitted.

If the System Exclusive Transmit, "SystemExclusive Transmit" setting located in the same page is **ON**, data for an individual sound (program or MultiSet) will be transmitted when a program change occurs.

This data is also transmitted when a corresponding dump request is received.

This data is transmitted and received on the Global MIDI channel.

□ Editing sounds etc.

By using MIDI system exclusive messages, individual parameters can be edited from an external device. In order for this to be possible, the MIDI mode MIDI SystemEX page setting System Exclusive Transmit, "System-Exclusive Transmit" must be **ON**, and System Exclusive Receive, "SystemExclusive Receive" set to **ENA**.

* In the MIDI SystemEX page, if programs or MultiSets are dumped by bank or individually to a specified dump destination, the received data will be written directly into backed-up memory, so it will not be necessary to execute the Write operation. However a data dump that occurs when a program or MultiSet is selected or editing that occurs as a result of a parameter change will affect the data in editing memory, so the Write operation will be necessary if the modified data is to be saved. (The Write operation is not necessary for MIDI parameters or Global parameters.) The Write operation can be performed by a MIDI exclusive message Program Write Request, MultiSetup Write Request, or Arpeggio Pattern Write Request.

□ Using MIDI to control an LFO

The cycle of an LFO can be synchronized to MIDI Clock messages. In the LFO section parameter "MIDI Sync," specify how the LFO will be synchronized. Set the "MIDI Sync Base" and "MIDI Sync Time" parameters to specify how the LFO cycle will relate to the MIDI Clock messages. Whether the Z1 will function as master (controlling device) or slave (controlled device) can be specified in the MIDI mode MIDI Basic page "Clock Source" parameter.

□ About the Performance Editor

The performance editor allows you to edit assigned parameters while in Program Play mode and MultiSet Play mode. When you use the performance editor to modify the sound, the corresponding changes are also transmitted as system exclusive parameter change messages (if the MIDI SystemEX page setting "SystemExclusive Transmit" is **ON**).

When these messages are received, the receiving device will execute the same performance editing operations. After editing, you can write the modified data into internal or card memory.

These messages are transmitted and received on the Global MIDI channel. Changes made using performance editor knobs [1] to [5] are transmitted and received as control change messages #19 to #23.

□ Controlling the arpeggiator

Arpeggiator synchronization

In Program Play mode or MultiSet Play mode, the arpeggiator can be operated in synchronization with an external device. Whether the Z1 will function as master (controlling device) or slave (controlled device) can be specified in the MIDI mode MIDI Basic page "Realtime Control" parameters.

When the Clock Source, "Clock Source" is set to **INT** (Internal), the Z1 will be the master, and the arpeggiator speed can be controlled from the front panel. The notes played by the arpeggiator will also be transmitted via MIDI, so they can be used to play an external MIDI tone generator or to control the tempo of a sequencer.

When the Clock Source, "Clock Source" is set to **EXT** (External), the Z1 will be the slave, and the arpeggiator speed will follow the incoming MIDI Clock messages. If "Realtime Control Receive" is set to **ENA**, MIDI realtime messages (Start, Stop, Continue) and Song Position Pointer messages will be received. In this case, be aware that the arpeggio will not play until a start or a continue message is received.

Arpeggiator operations can be transmitted and received via MIDI messages.

Pattern select (can be transmitted and received)

[Bn 63 00 Bn 62 01 Bn 06 nn]

nn: 00 to 13 (internal), 40 to 53 (card)

Arpeggio on/off [Bn 63 00 Bn 62 02 Bn 06 nn]

nn: 00 to 3F (off), 40 to 7F (on)

Arpeggio octave [Bn 63 00 Bn 62 03 Bn 06 nn]

nn: 00 to 03 (1 to 4 octaves)

Arpeggio latch [Bn 63 00 Bn 62 04 Bn 06 nn]

nn: 00 to 3F (off), 40 to 7F (on)

Arpeggio key sync [Bn 63 00 Bn 62 05 Bn 06 nn]

nn: 00 to 3F (off), 40 to 7F (on)

Arpeggio keyboard on/off

[Bn 63 00 Bn 62 06 Bn 06 nn]

nn: 00 to 3F (off), 40 to 7F (on)

Arpeggiator resolution, gate and velocity

The arpeggio resolution, gate and velocity values can be controlled from a sequencer etc. by control changes #09, #14 and #15 respectively.

2. Z1

MIDI Implementation chart

Date : 1997. 07. 07

Function...		Transmitted	Recognized	Remarks
Basic channel	Default	1 to 16	1 to 16	Memorized
	Changed	1 to 16	1 to 16	
Mode	Default	× *****	3 to 4	Memorized
	Messages Altered		Omni ON/OFF	
Note Number:	True voice	0 to 127 *****	0 to 127 0 to 127	
	Velocity	○9n, V=1 to 127 ×	○9n, V=1 to 127 ×	*B
After Touch	Key's	×	×	*A
	Ch's	○	○	
Pitch Bender		○	○	*C
Control Change	0, 32	○	○	Bank Select (MSB, LSB) *P, *C
	1	○	○	Modulation *C
	5	×	○	Portamento Time *C
	6	○	○	Data Entry (MSB) *C
	7, 11, 10	○	○	Volume, Expression, Pan Pot *C
	64, 66	○	○	Sustain, Sostenuto *C
	65	○	○	Portamento Switch *C
	91, 92, 94, 95	×	○	Effect Depth, Effect Switch *C
	96, 97	×	○	Data Increment/Decrement
	98, 99	○	○	NRPN (LSB, MSB)
	120, 121	×	○	All Sound Off, Reset All Controls
	122, 124 0 to 95	×	○	Local Control, Omni mode On/Off Wheel, X-Y Pad, Foot Pedal, Knob *C
Program Change:	True#	○ 0 to 127 0 to 127	○ 0 to 127 0 to 127	*P
	System Exclusive	○	○	*2, *E
System Common	: Song Pos	×	○	
	: Song Sel	×	×	
	: Tune	×	×	
System Real Time	: Clock	○	○	*1
	: Commands	×	○	
Aux Messages	: Local ON/OFF	×	○	
	: All Notes OFF	×	○ 123 to 127	
	: Active Sense	○	○	
	: Reset	×	×	

Notes *A, *B, *C, *E, *P: Valid only when Global parameter settings permit transmission and reception.

*1: Only transmitted when Clock is Internal. Only received when Clock is External.

*2: In addition to Korg exclusive messages, also compatible with Enquiry messages.

Mode 1: OMNI ON, POLY
Mode 3: OMNI OFF, POLY

Mode 2: OMNI ON, MONO
Mode 4: OMNI OFF, MONO

○: Yes
×: No

* Consult your local Korg distributor for more information on MIDI IMPLEMENTATION.

3. Mod. Source List

Mod. Source List 1	
ID	Modulation Sources
0	Off
1	EG1
2	EG2
3	EG3
4	EG4
5	Amp EG
6	LFO1
7	LFO2
8	LFO3
9	LFO4
10	Portamento
11	Note[Linear]
12	Note[Exp]
13	Note Split[High]
14	Note Split[Low]
15	Velocity[Soft]
16	Velocity[Medium]
17	Velocity[Hard]
18	Pitch Bend
19	After Touch
20	Modulation Wheel(CC#1)
21	ATouch+Mod.Wheel
22	Mod.Wheel+ATouch/2
23	X[+/-](CC#16)
24	X[+](CC#16)
25	X[-](CC#16)
26	Y[+/-](CC#17)
27	Y[+](CC#17)
28	Y[-](CC#17)
29	Knob1(CC#19)
30	Knob2(CC#20)
31	Knob3(CC#21)
32	Knob4(CC#22)
33	Knob5(CC#23)
34	Mod.SW1(CC#80)
35	Mod.SW2(CC#81)
36	Foot SW(CC#82)
37	Foot Pedal(CC#4)
38	Damper(CC#64)
39	Sostenuto(CC#66)
40	MIDI Breath Control(CC#2)
41	MIDI Volume(CC#7)
42	MIDI Panpot(CC#10)
43	MIDI Expression(CC#11)
44	MIDI Portamento Time(CC#5)
45	MIDI Portamento SW(CC#65)
46	Master FX OFF/ON(CC#92)
47	FX1 OFF/ON(CC#94)
48	FX2 OFF/ON(CC#95)

Mod. Source List 2	
ID	Modulation Sources
0	Off
11	Note[Linear]
12	Note[Exp]
13	Note Split[High]
14	Note Split[Low]
15	Velocity[Soft]
16	Velocity[Medium]
17	Velocity[Hard]
18	Pitch Bend
19	After Touch
20	Modulation Wheel(CC#1)
21	ATouch+Mod.Wheel
22	Mod.Wheel+ATouch/2
23	X[+/-](CC#16)
24	X[+](CC#16)
25	X[-](CC#16)
26	Y[+/-](CC#17)
27	Y[+](CC#17)
28	Y[-](CC#17)
29	Knob1(CC#19)
30	Knob2(CC#20)
31	Knob3(CC#21)
32	Knob4(CC#22)
33	Knob5(CC#23)
34	Mod.SW1(CC#80)
35	Mod.SW2(CC#81)
36	Foot SW(CC#82)
37	Foot Pedal(CC#4)
38	Damper(CC#64)
39	Sostenuto(CC#66)
40	MIDI Breath Control(CC#2)
41	MIDI Volume(CC#7)
42	MIDI Panpot(CC#10)
43	MIDI Expression(CC#11)
44	MIDI Portamento Time(CC#5)
45	MIDI Portamento SW(CC#65)

Mod. Wheel Modulation wheel or aftertouch will apply & ATouch /2 the effect. At this time, the intensity of aftertouch will be half that of the modulation wheel, and only half of the depth can be obtained.

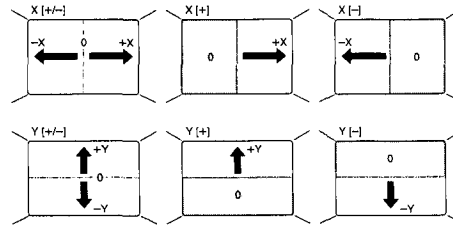

Mod.SW1, Mod.SW2 If you wish to use the panel switches as a modulation source, make settings of SW1=Modulation (CC#80) and SW2=(CC#81) for the Prog CMN SW & Pdl page or MLT CMN SW & Pdl page parameters "SW1/2 Function."

Foot SW If you wish to use the assignable foot switch as a modulation source, set Foot Switch=Modulation (CC#82) in the Prog CMN SW&Pdl page or the MLT CMN SW&Pdl page. You can use a foot switch etc. connected to the ASSIGNABLE SW jack to control the effect.

Foot Pedal If you wish to use the assignable foot pedal as a modulation source, set Foot Pedal=Foot Controller (CC#04) in the Prog CMN SW&Pdl page or the MLT CMN SW&Pdl page. You can use a foot controller etc. connected to the ASSIGNABLE PEDAL jack to control the effect.

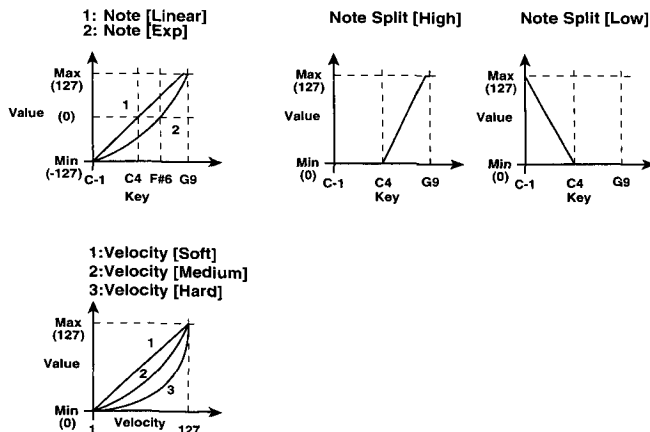

* The above curves will be applied after the curve specified by GLB Basic page "After Touch Curve" has taken effect.

4. Utility list

Utility functions are provided to assist you with changes that would be tedious to make by performing individual edits. Appropriate utility menus are provided in several pages, allowing you to modify data in units of an entire block (mode, section, page).

[Init], [Copy] and [Swap] are typical utility operations which allow you to initialize, copy or exchange data in block units. Initialize [Init] lets you set the specified unit of data to standard settings. In some cases you can choose the desired type of settings.

Copy [Copy] allows data to be copied from another block, program, or MultiSet.

Exchange [Swap] lets you exchange settings of the currently-edited block.

In Program Edit mode, the display will indicate [PE Def] when the cursor is located at a parameter which can be assigned to the Performance Editor, allowing you to assign that parameter to a knob (see p.20).

For the procedure, refer to p.27.

□ Program Play mode

UTILITY: **UsrGrp, Categr, Init, Factory**

[2] UsrGrp: Search for a program by user group.

[3] Categr: Search for a program by category.

[4] Init: Initialize the currently-edited program.

[5] Factory: Load factory setting data into the currently-edited program.

□ Program Edit mode

OSC section

< OSC Set Up page >

UTILITY: **CpySet**

[4] CpySet: Copy all OSC section settings from another program.

<OSC1 page> <OSC2 page> Pitch tab

UTILITY: **Init, Copy**

[3] Init: Initialize the selected OSC type.

[4] Copy: Copy OSC1 or OSC2 settings from another program.

< SubOSC page >

UTILITY: **Copy**

[3] Init: Initialize Sub OSC settings.

[4] Copy: Copy Sub OSC settings from another program.

< Noise Generator page >

UTILITY: **Copy**

[4] Copy: Copy Noise Generator settings from another program.

Prog Mixer section

< Mix Level page > < Mix Mod. page >

UTILITY: **Copy, Reset**

[4] Copy: Copy all Prog Mixer settings from another program.

[5] Reset: Set all values of the Prog Mixer section to 0.

Filter section

< Filter Routing page >

UTILITY: **Copy, (Swp1-2)**

[4] Copy: Copy all settings of the Filter section from another program.

[5] Swp1-2: Exchange the contents of Filter 1 and Filter 2. Not available if "Link SW" is ON.

< Filter 1 page > < Filter 1 Kbd Track page > < Filter 2 page >

< Filter 2 Kbd Track page >

UTILITY: **Copy**

[4] Copy: Copy the Filter 1 or Filter 2 settings from another program.

Amp section

< Amplitude page >

UTILITY: **Copy, Duplic, Swp1-2**

[3] Copy: Copy all Amp section settings from another program.

[4] Duplic: Copy the currently-edited Amp1 or Amp2 settings to the other Amp.

[5] Swp1-2: Exchange the Amp1 and Amp2 settings.

< AmpEG page >

UTILITY: **Init, Copy**

[3] Init: Initialize the AmpEG using eleven templates (Default, Piano, Bell, Guitar, Percussion, Organ, SoftAttack, SlowAttack, SoloStrings, Sweep, Pressure).

[4] Copy: Copy EG 1 to 4 or AmpEG settings from another program.

[5] Swap: Exchange AmpEG settings with the settings of another EG.

EG section

< EG1 page > < EG2 page > < EG3 page > < EG4 page >

UTILITY: **Init, Copy, Swap**

[3] Init: Initialize the selected EG using eleven templates (Default, Piano, Bell, Guitar, Percussion, Organ, SoftAttack, SlowAttack, SoloStrings, Sweep, Pressure).

[4] Copy: Copy the EG1 to 4 or AmpEG settings from another program.

[5] Swap: Exchange EG settings with the contents of another EG.

LFO section

< LFO1 page > < LFO2 page > < LFO3 page > < LFO4 page >

UTILITY: **Copy, Swap**

[4] Copy: Copy the LFO1 to 4 settings from another program.

[5] Swap: Exchange LFO settings with the contents of another LFO.

Prog Fx section

< Effect Set Up page >

UTILITY: (Swp1-2), CpyPrg, CpyMlt

[3] Swp1-2: Exchange Fx1 and Fx2. However this is not available if Fx1 is TalkingMod. to RotarySP(L).

[4] CpyPrg: Copy all settings from the Prog Fx section of another program.

[5] CpyMlt: Copy MultiSet effect data of a specified section.

< Fx1 page > < Fx2 page >

UTILITY: Init, CpyPrg, CpyMlt

[3] Init: Initialize the settings for the specified effect.

[4] CpyPrg: Copy Fx1 or Fx2 settings from another program.

[5] CpyMlt: Copy Fx1 or Fx2 settings from a MultiSet.

< MasterFx page >

UTILITY: Init, CpyPrg, CpyMlt

[3] Init: Initialize settings for the selected effect.

[4] CpyPrg: Copy MasterFx settings from another program.

[5] CpyMlt: Copy MasterFx settings from a MultiSet.

< MasterEQ page >

UTILITY: CpyPrg, CpyMlt

[4] CpyPrg: Copy MasterEQ settings from another program.

[5] CpyMlt: Copy MasterEQ settings from a MultiSet.

Prog Common section

< CMN Mod.Src List page >

UTILITY: Refrsh, Change, Exchnng

[3] Refrsh: After editing, sort the list by Mod.Source.

[4] Change: Replace a Mod.Source with another Mod.Source. However, this will be invalid for parameters whose value would exceed their range as a result of the change. After execution, the list order will automatically be sorted by Mod.Source.

[5] Exchnng: Exchange two types of Mod.Source.

< CMN PE Define page >

UTILITY: (Return), Init, Copy, Swap

[2] Return: This will appear if you use UTILITY:[PE Def] to enter this page. This utility function will return you to the previous page.

[3] Init: Initialize PE settings.

[4] Copy: Copy PE settings from another program.

[5] Swap: Exchange the PE settings of a knob with the PE settings of another knob.

MultiSet Play mode

UTILITY: [Init] [Factory]

[4] Init: Initialize the currently-edited MultiSet.

[5] Factory: Load factory setting data into the currently-edited MultiSet.

MultiSet Edit mode

Multi Fx section

< Effect Set Up page >

UTILITY: (Swp1-2), CpyPrg, CpyMlt

< Fx1 page > < Fx2 page >

UTILITY: Init, CpyPrg, CpyMlt

< MasterFx page >

UTILITY: Init, CpyPrg, CpyMlt

< MasterEQ page >

UTILITY: CpyPrg, CpyMlt

Refer to the Prog Fx section of Program Edit mode.

Arpeggio mode

< PAT Step Param page >

UTILITY: Init, Stp Cpy, Delete, Insert

[2] Init: Initialize the arpeggio pattern step parameters (Step Tone, Step Offset, Step Gate, Step Velocity, Step Split).

[3] Stp Cpy: Copy the step parameters of the currently selected Step Number to another step.

[4] Delete: Delete the step parameters of the currently selected Step Number. Subsequent steps will be shifted one step toward the left.

[5] Insert: Insert a blank step at the currently selected Step Number. Subsequent steps will be shifted one step toward the right.

MIDI mode

< MIDI Prog Map page >

UTILITY: Equal

< MIDI Multi Map page >

UTILITY: Equal

[4] Equal: Set the "External Program #" to the internal Program / MultiSet numbers.

< MIDI CChg Filter page >

UTILITY: SetAll, SetAll, Regula

[3] SetAll: Set all "Transmit" settings of the list to either OFF or ON.

[4] SetAll: Set all "Receive" settings of the list to either DIS or ENA.

[5] Regula: Regularize the "Translation." The Z1's MIDI messages and the messages transmitted/received will be the same.

Global mode

< GLB User Scale page >

UTILITY: Reset, Reset

[2] Reset: Set all values of "UserScale1 Detune" to 0 (same as EQUAL_TEMP).

[5] Reset: Set all values of "UserScale2 Detune" to 0 (same as EQUAL_TEMP).

OSC1 OSC2 Parameter Name	OSC1 OSC2 Parameter Name	OSC1 OSC2 Parameter Name	OSC1 OSC2 Parameter Name
[Sync Mod.OSC]	160 String Position	205 217 Pre High EQ Gain	207 Rotor Acceleration
158 179 Slave Wave	161 String Position Mod. Intensity		208 Rotor Rate
159 180 Wave Edge	162 Dispersion	[Decimator]	209 Mode
[Organ Model]	163 Dispersion Mod.Intensity	200 212 Effect Balance	Master Fx Type
158 179 (Drawbar1) Wave	164 Damping	201 213 Sampling Frequency	[Stereo Delay]
159 180 Harmonics	165 Decay	202 214 Output Level	224 Effect Balance
160 181 Fine	166 Release	203 215 Resolution	225 Input Level Mod. Intensity
161 182 Level	167 Harmonics Position	[Chorus]	226 Left Delay Time
162 183 Level Mod. Intensity	168 Harmonics Mod.Intensity	200 212 Effect Balance	227 Right Delay Time
163 184 Percussion Level	169 Pickup Position	201 213 LFO Frequency	228 Feedback(L)
164 185 (Drawbar2) Wave	170 Pickup Position Mod. Intensity	202 214 Depth	229 Feedback(R)
165 186 Harmonics	171 Low EQ Freq	203 215 Depth Mod. Intensity	230 High Damp
166 187 Fine	172 Low EQ Gain	204 216 Pre Low EQ Gain	[Reverb-Hall]
167 188 Level	173 Low Boost	205 217 Pre High EQ Gain	224 Effect Balance
168 189 Level Mod. Intensity	[Bowed String Model]	[Flanger]	225 Reverb Time
169 190 Percussion Level	158 Bow Speed EG Intensity	200 212 Effect Balance	226 Pre Delay
170 191 (Drawbar3) Wave	159 Bow Speed Mod.1 Intensity	201 213 LFO Frequency	227 High Damp
171 192 Harmonics	160 Bow Speed Mod.2 Intensity	202 214 Depth	228 Pre Low EQ Gain
172 193 Fine	161 Bow Differential	203 215 Delay Time	229 Pre High EQ Gain
173 194 Level	162 Pressure EG Intensity	204 216 Feedback	[Reverb-Room]
174 195 Level Mod. Intensity	163 Pressure Mod. Intensity	[Phaser]	224 Effect Balance
175 196 Percussion Level	164 Rosin Amount	200 212 Effect Balance	225 Reverb Time
176 197 (Percussion) Trigger Mode	165 String Position	201 213 LFO Frequency	226 Pre Delay
177 198 Decay	166 String Position Mod. Intensity	202 214 Depth	227 High Damp
178 199 Percussion Level Mod.Intensity	167 Damping	203 215 Manual	228 Pre Low EQ Gain
[Electric Piano Model]	168 Dispersion	204 216 Resonance	229 Pre High EQ Gain
158 179 (Hammer) Force	169 Reflection	[Rotary Speaker(S)]	
159 180 Force Velocity Curve	170 Reflection Mod. Intensity	200 212 Effect Balance	
160 181 Width	171 PEQ Freq	201 213 Speed	
161 182 Click Level	172 PEQ Q	202 214 Horn Acceleration	
162 183 (Tone Gen.) Decay	173 PEQ Gain	203 215 Horn Rate	
163 184 Release	Fx1 Fx2 Effect1/2 Type	204 216 Horn/Rotor Balance	
164 185 Overtone Level	[Overdrive]	205 217 Mic Distance	
165 186 Overtone Freq	200 212 Effect Balance	[Delay(Mono)]	
166 187 Overtone Decay	201 213 Drive	200 212 Effect Balance	
167 188 (Pickup) Pickup Position	202 214 Output Level	201 213 Input Level Mod. Intensity	
168 189 Pickup Position Mod. Intensity	203 215 Low EQ Freq	202 214 Delay Time	
169 190 (Low EQ) Low EQ Freq	204 216 Low EQ Gain	203 215 Feedback	
170 191 Low EQ Gain	205 217 Mid Low EQ Freq	204 216 Low Damp	
[Brass Model]	206 218 Mid Low EQ Gain	205 217 High Damp	
158 Pitch Bend+	207 219 Mid High EQ Freq	[Talking Modulator]	
159 Pitch Bend-	208 220 Mid High EQ Gain	200 Effect Balance	
160 Pressure EG Intensity	209 221 High EQ Freq	201 Manual Control	
161 Pressure Mod.1 Intensity	210 222 High EQ Gain	202 Voice Top	
162 Pressure Mod.2 Intensity	[Compressor]	203 Voice Center	
163 Lip Character	200 212 Effect Balance	204 Voice Bottom	
164 Lip Character Mod. Intensity	201 213 Sensitivity	205 Formant Shift	
165 Bell Tone	202 214 Attack	206 Resonance	
166 Bell Resonance	203 215 Pre Low EQ Gain	[Multitap Delay]	
167 Noise Level	204 216 Pre High EQ Gain	200 Effect Balance	
168 PEQ Freq	205 217 Output Level	201 Type	
169 PEQ Q	[Parametric EQ]	202 Input Level Mod.Intensity	
170 PEQ Gain	200 212 Effect Balance	203 Tap1 Time	
171 Strength	201 213 Low EQ Freq	204 Tap1 Level	
[Reed Model]	202 214 Low EQ Gain	205 Tap2 Time	
158 Pitch Bend+	203 215 Mid Low EQ Freq	206 Feedback	
159 Pitch Bend-	204 216 Mid Low EQ Gain	207 High Damp	
160 Pressure EG Intensity	205 217 Mid High EQ Freq	208 Spread	
161 Pressure Mod.1 Intensity	206 218 Mid High EQ Gain	[Ensemble]	
162 Pressure Mod.2 Intensity	207 219 High EQ Freq	200 Effect Balance	
163 Noise Level	208 220 High EQ Gain	201 Speed	
164 Reed Mod.Intensity	[Wah]	202 Shimmer	
165 HPF Fc	200 212 Effect Balance	203 Depth	
166 HPF Resonance	201 213 Frequency Bottom	[Rotary Speaker(L)]	
167 Offset	202 214 Frequency Top	200 Effect Balance	
168 Shape	203 215 Sweep Response	201 Speed	
169 Shape Mod.Intensity	204 215 Resonance	202 Horn Acceleration	
170 PEQ Freq	205 216 Envelope Sens	203 Horn Rate	
171 PEQ Q	205 217 Envelope Shape	204 Horn/Rotor Balance	
172 PEQ Gain	[Exciter]	205 Mic Distance	
[Plucked String Model]	200 212 Effect Balance	206 Mic Spread	
158 Attack Curve Up	201 213 Blend		
159 Attack Curve Down	202 214 Blend Mod. Intensity		
	203 215 Emphatic Point		
	204 216 Pre Low EQ Gain		

6. About the optional <DI-TRI digital I/F board>

The separately sold <DI-TRI digital I/F board> option provides an ADAT™ compatible optical output which digitally outputs the audio signal from the Z1, and also allows the digital signal to be synchronized with another digital audio device.

 If you have questions regarding installation, contact a nearby Korg dealer.

□ DIGITAL OUT connector

This is a digital output connector in ADAT Optical format. Connect it to the DIGITAL IN connector of an ADAT optical format-compatible mixer or recorder. The output of the Z1's R and L/MONO output jacks and of the audio signals that have bypassed the master effects will be output from the DIGITAL OUT connector, occupying channels 1, 2, 3 and 4 respectively of the eight channels of the ADAT Optical format. At this time, audio signals will also be output from the analog jacks.

□ WORD CLOCK IN connector

This is an input jack for the system clock. When the Z1's WORD CLOCK IN connector is connected to an ADAT Optical format mixer or remote controller which has a WORD CLOCK OUT connector, the Z1 will synchronize to the sampling frequency of the connected device.

□ Example connections

Digitally recording the sound of the Z1 to an ADAT

- ① Use an ADAT-OPTICAL cable (sold separately) to connect the Z1's DIGITAL OUT connector to the ADAT's Digital INPUT. For connections, use an ADAT-OPTICAL cable manufactured by Alesis Corporation or an optical cable for CD/DAT (both sold separately).
- ② Press the DIGITAL INPUT switch of the ADAT. If you are using an ADAT XT, set the CLOCK SOURCE of the ADAT XT to "DIG 48K."
- ③ Set the Z1's Global mode GLB Ctrl SetUp page setting "Word Clock Source" to INT.

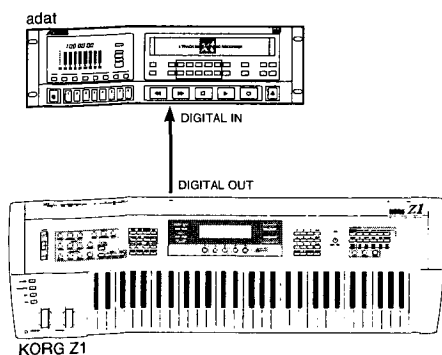

Digitally recording the sound of the Z1 that has been mixed on a digital mixer to the ADAT

- ① Use an ADAT-OPTICAL cable to connect the Z1's DIGITAL OUT connector to the ADAT OPTICAL IN connector of the ADAT Optical format-compatible mixer.
- ② Use ADAT-OPTICAL cables to connect the respective IN and OUT connectors of the ADAT Optical format-compatible mixer and the ADAT.
- ③ In order to use an ADAT Optical format-compatible mixer or remote controller as the master for synchronization of the digital signals, make connections as shown in the diagram below, and connect the mixer's WORD CLOCK OUT connector to the Z1's WORD CLOCK IN connector. For connections, use a BNC Coax cable made by Alesis Corporation or a BNC cable made for video (both sold separately).
- ④ Press the DIGITAL INPUT switch of the ADAT. If you are using an ADAT XT, set the CLOCK SOURCE of the ADAT XT to "DIG 48K."
- ⑤ Set the Z1's Global mode GLB Ctrl SetUp page setting "Word Clock Source" to EXT.

The digital audio signal that is output from the DIGITAL OUT connector is output in synchronization with the clock signal received at the WORD CLOCK IN jack, allowing the digital signals of the two devices to be synchronized.

 If the clock cannot be detected correctly due to a disconnected BNC cable or for some other reason, an error message will appear in the LCD. If this occurs, check whether a problem has occurred with the BNC cable.

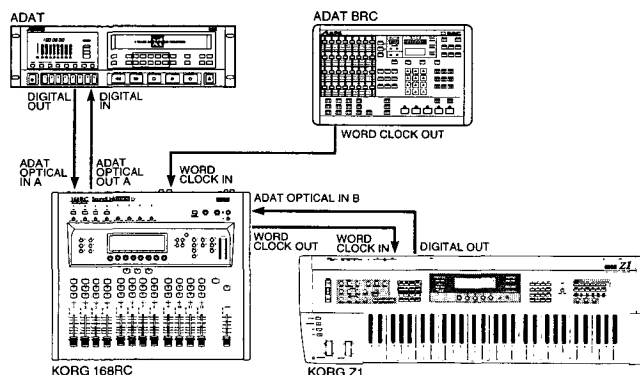

7. About the optional <DSPB-Z1 option board>

By installing a separately sold <DSPB-Z1 option board> you can add six voices to the Z1's polyphony, providing a maximum of 18 voices of polyphony.

 If you have questions regarding installation, contact a nearby Korg dealer.

8. About the Memory Card

A memory card inserted into the CARD slot located on the rear panel of the Z1 can store programs, MultiSets, Global settings and arpeggio patterns.

❑ Memory cards that can be used with the Z1

- PC CARD ATA specification Flash ROM
- PC CARD Device Type: Flash EPROM

Either of these two types of card can be used as long as their capacity is between 256 Kbytes and 4M bytes.

❑ Memory card handling

While a memory card procedure is taking place, do not remove the card or transmit MIDI data dumps, etc. If any of these events occur, data may be lost.

For details on memory card handling, refer to the owner's manual that was included with your memory card.

❑ Formatting a memory card

Before a new memory card can be used by the Z1, the card must be formatted. The format operation is performed by the GLB Data Utility "(Format Card) Target Card Area" (refer to p.95).

When you format a memory card, all data which was previously on the card will be lost forever.

❑ Saving data to a memory card

To save data to a card, use the GLB Data Utility (Save) (refer to p.95). The data will be written to the area that has been specified by GLB Basic "Card Area Select" (refer to p.91). If you are using an ATA specification Flash ROM card, you will also be able to use the program, MultiSet, or arpeggio pattern Write operations to write data to the card.

When using a Device Type: Flash EPROM memory cards, it is not possible to use the Write operation (refer to p.26) to write edit buffer data directly into the memory card. You must first save the data to internal memory, and then in the GLB Data Utility "Save Source" select **All_Data** to save it (refer to p.95).

❑ Reading data from a memory card

Programs, MultiSets and arpeggio patterns from a card can be selected for playing in Program Play mode or MultiSet Play mode by pressing the [INT/CARD] key (refer to p.4, 5, 10). The data will be read from the area that has been specified by GLB Basic "Card Area Select" (refer to p.91).

If you wish to load data from a memory card into internal memory, use the GLB Data Utility (Load) Card (refer to p.94).

9. Troubleshooting

LCD display does not appear when you press the POWER switch.

- Is the power cable connected to an electrical outlet? p.xiii

No sound!

- Is the amp or headphones connected correctly? ... p.xiii
- Is the Z1's master volume raised? p.2
- Is the MIDI Basic page "Local Control" turned ON? p.86
- Are the GLB Basic page "Polarity" settings correct? p.91
- Make sure that none of the level-related parameters in each section have been set to 0.
- If you have connected only the L/MONO OUTPUT jack, make sure that the GLB Ctrl & Fx page parameter "Output Mode" is set to **MONO**. p.94

Sound does not stop!

- Is the Prog CMN Voice page "HOLD" setting OFF? p.60
- Are the GLB Basic page "Polarity" settings correct? p.91

The sound does not match the settings!

- Did you execute the Write operation after editing? p.26
- Was the program sound changed when a MultiSet was saved? p.9

Can't write programs, MultiSets or patterns!

- Make sure that the GLB Basic page parameter "Memory Protect" is OFF. p.25, 91

Transpose and velocity curve settings are not transmitted/received correctly!

- Is the GLB Basic page parameter "Transpose Position" set correctly? p.90

Arpeggiator does not start!

- Is the ARPEGGIATOR [ON/OFF] turned on (LED lit)? p.10
- Is the MIDI Basic page parameter "Clock Source" set correctly? p.86
- Are the Arpeggio mode "Kbd Scan Zone Bottom/Top" parameters set correctly? p.83

Arpeggiator does not link to programs or MultiSets!

- Make sure that the GLB Ctrl SetUp page "Auto Arpeggiator Program/MultiSet" setting is ON. p.94

The specified effect does not apply!

- Make sure that the GLB Ctrl SetUp page parameter "Master Effect" is set to **AVAIL**. p.94

Cannot control via MIDI!

- Are MIDI cable connections correct? p.97
- Make sure that the MIDI channel of the data being transmitted from the external MIDI device matches the Global MIDI channel of the Z1. p.97

Cannot format a memory card!

- Is the memory card a type which the Z1 can use? ..p.95
- Is the memory card inserted correctly? p.xii

Cannot save data to a memory card!

- Is the memory card inserted correctly? p.xii
- Is the memory card formatted? p.95
- If you are using a Flash EPROM device type memory card, several restrictions will apply to saving. p.110

Cannot load data from a memory card!

- Is the memory card inserted correctly? p.xii
- Does the memory card contain data? p.110
- Is the correct area of the memory card selected? p.91

When using the DI-TRI option, undesired noise occurs or sound is distorted!

- If the Z1 is the master, make sure that the ADAT clock setting is correct. p.93, 109
- If the Z1 is the slave, make sure that the word clock signal is being input correctly. p.93, 109

When using the DI-TRI option, cannot send/receive digital audio!

- Is the cable connected correctly? p.109
- Is the GLB Ctrl SetUp page parameter "Word Clock Source" set correctly? p.93, 109

10. Error messages

WARNING! Internal battery is LOW

The backup battery has run down. Contact a nearby Korg service center or your dealer.

!Data Dump Error! <Found Illegal Data>

Reception could not be performed correctly, since inappropriate MIDI dump data was received. All of the received contents have been discarded.

!Dump Data Error! <Memory is Protected>

Since the Z1's "Memory Protect" is ON, MIDI dump data could not be received correctly. All of the received contents have been discarded.

!! No Area !!

!! No Card !!

No card was inserted when you attempted to write data etc. to a card.

! Protected Card !

The memory card is write protected.

Not a valid Card!

When you attempted to read data from a memory card, the card format was inappropriate.

!! Card Error !!

A malfunction has been detected in the memory card.

Card Type ERR!

Since the memory card is a Flash EPROM type device, it was not possible to write data from the edit buffer directly into the card. You must first save the data to internal memory, and then use the GLB page Data Utility to save all data to the memory card.

11. Other messages

<Execute?>

This message asks you to confirm that you wish to execute an operation. Press the [ENTER] key to execute, or press the [EXIT] key to cancel the operation.

<Are you sure?>

<Sure?>

This message asks you to confirm that you wish to execute an operation. Press the [ENTER] key to execute, or press the [EXIT] key to cancel the operation.

<Format?>

The memory card is not formatted. This message will appear when you attempt to write to a new card (or a new card area), or to a card which has been formatted differently.

<<<<Completed!>>>>

The process has been completed successfully.

<!Memory Protected!>

"Memory Protect" was ON when you attempted to write to internal memory, etc.

Can't access CARD Change to INT Program?

Can't access CARD Change to INT Multi?

Can't access CARD Change to INT Pattern?

The card has been removed after you selected a memory card program, etc. It is not possible to select programs etc. from the card. Either re-insert the memory card, or press the [ENTER] key or the [INT/CARD] key to select internal data. Pressing any other key will cause the previous display to reappear.

Di-tri clock error

When using the optional <DI-TRI>, this message will appear if the required external clock input cannot be detected. Either check the clock generating source, or set "Word Clock Source" EXT (external clock) to INT.

Recall previous edit?

After editing, this message will appear to ask whether you wish to recall unsaved data. To recall the data, press the [ENTER] key.

Now Receiving Data!

MIDI dump data is being received. This message will appear if a significant time interval elapses before reception is completed, such as when the volume of data is large etc. While this message is displayed, some operations such as program changes or editing will be restricted.

"***DATA"Received <<<<Completed!>>>>

Reception of a MIDI data dump has been completed, and *** data (for example, ALL DATA, Program A000 etc.) has been received. Verify that the correct data is shown, and press any key to return to the previous display.

DUMP RECEIVED

This message will appear after MIDI dump data has been received for the program or MultiSet which is currently being played or edited. This data is treated as an edit, so you will need to write it into memory if you wish to keep it.

Executing Dump Required

Data is being transmitted in response to a MIDI data dump request that was received from an external device. This message will appear if a significant time interval elapses before transmission is completed.

MIDI Write Request Received Program Write <<<Completed!>>

Data has been written in response to a MIDI write request that was received from an external device, subject to the same conditions that apply for conventional Write operations (such as "Memory Protect" being OFF, etc.). This message will appear if the operation ended normally.

12. Specifications

System	MOSS (Multi-Oscillator Synthesis System)
Tone generator section	12 voice (6 voices can be added with an optional board, expanding the total to 18 voices), 2 oscillators (max.) + suboscillator + noise generator
Keyboard	61 note (with initial and aftertouch)
Effects	Digital multi-effects Fx1 / Fx2 = 15 types, Mst.Fx= 3 types
Programs	128 programs x 2 banks
MultiSets	16 setups x 2 banks
Arpeggiator	5 preset patterns, 15 user patterns
Controllers	Pitch bender, Modulation wheel, X-Y pad, Modulation SW1 & 2, X-Y Hold SW, Portamento SW, Knobs 1 to 5, Filter knobs (Cutoff, Resonance, EG intensity), Filter EG knobs (ADSR), Amp EG knobs (ADSR), Arpeggiator control knobs (Resolution, Gate, Velocity, Speed)
Control inputs	Damper pedal, Assignable switch, Volume pedal, Assignable pedal
Outputs	L/Mono, R, Headphones
MIDI	IN, OUT, THRU
Card slot	Program data, MultiSets, Arpeggio patterns
Display	64 x 240 dots LCD
Power supply	AC, Local Voltage
Power consumption	23 W
Dimensions	1,090.1 (W) x 348.3 (D) x 118.7 (H) mm
Weight	13.9 kg
Included items	AC cable

Options

DSPB-Z1	option board (6 additional voices)
DI-TRI	digital I/F board (ADAT compatible optical)
XVP-10	EXP/VOL pedal
KVP-002	Volume pedal
EXP-2	foot controller
PS-1 / PS-2	pedal switch
DS-1H	damper pedal

13. Index

Symbol

2BPF (Dual Band Pass Filter) 53, 54

A

Acoustic instruments 61
Aftertouch curve 90, 91
AMP 8, 13, 15, 17, 55, 105
AMP ENVELOPE 8, 17
Analog synthesizers 32, 61
Arpeggiator viii, 10, 23, 62, 79, 83, 86, 91, 102
 Gate 11, 83
 Link 11, 94
 MIDI 79, 86, 100, 102
 Pattern 10
 Speed 10, 59, 86
 User pattern 23, 83
 Velocity 11, 83
Arpeggio ix, 10, 13, 23, 26, 79, 83, 91, 106
Assignable pedal xii, xiii, 7, 62, 82, 91, 93, 99, 104
Assignable SW xii, xiii, 6, 17, 62, 82, 91, 100, 104
AUTO 11

B

Backup battery iii, 111
Bank viii, 3, 5, 9, 10, 77, 87, 98
Bank select 87, 98
Bore shape 42, 44
Bow pressure 48
Bowed string model 19, 30, 48
BPF (Band Pass Filter) 53
Brass model 19, 30, 42
BRF (Band Reject Filter) 53
Bypass 17, 94, 109

C

Calibration 93
Category 3, 26, 61
Chords strummed on a guitar 85
Clock 59, 86, 93, 109
Comb filter OSC 18, 30, 34
Compare 27
Copy 28, 105
Cross modulation OSC 18, 30, 39
Cursor 12, 14
Cutoff frequency 7, 16, 53

D

Damper xiii, 6, 22, 62, 99
Decimator 67
Demo songs 2
DI-TRI digital I/F board 93, 109
Drawbar 18, 40
 Percussion 41
DSPB-Z1 option board 77, 109
Dump 88, 91, 95, 98, 102

E

Edit 13
Edit buffer 25
Effect 17, 22, 59, 64, 81
 Copy 28, 106
 On/Off 18, 62, 82
 Send 18, 59, 77
 Type 59, 64, 81
EG 15, 19, 55, 57
Electric piano 18, 41
Electric piano model 18, 30, 41
Entry parameter name 12
Exchange (Swap) 28, 105
Expression 93, 99

F

Factory preset data 12, 28, 95
Factory settings 12, 28, 95
Filter 7, 15, 16, 37, 43, 44, 45, 50, 52, 105
FILTER EG 7, 16
Filter routing 16, 52
Fingerboard pressure 46, 48
Format 95
Fret 46
Fx 17, 22, 59, 62, 64, 81

G

Gate 11, 23, 24, 83, 100
Global channel 79, 80, 86, 97, 98
Guitar 45

H

Hammer 41
Harmonics 47
HPF (High Pass Filter) 53

I

Initialize 28, 95
Intensity 19

J

Jump bending 42, 44

K

Key sync 11, 58
KEYBD 10
Keyboard tracking 19, 32, 54, 55

L

LATCH 10
Layer ix, 22, 78
Legato 30
LFO 15, 19, 58
Link 11, 94, 52
Load 94, 95
Local on/off 86, 97
Lowering of the sampling frequency 67
LPF (Low Pass Filter) 53

M

Master effect	17, 60, 74, 81, 94, 101
Master EQ	60, 76, 81
Memory card	94, 110
Area	91
Memory protect	25, 91
MIDI	ix, 79, 86, 97
Channel	79, 86, 97
Clock	59, 86
Filter	80, 87, 98
Program change	4, 5, 79, 87, 98
Sync	59, 68, 69
System exclusive messages	88, 98, 101, 102
Mixer output	51
MOD WHEEL	6, 20, 80
Mode jump	6, 42
Moduration Source	19, 62, 104
Monaural output	94
Monophonic	60
MOSS (Multi-Oscillator Synthesis System)	viii
Mouthpiece	42
Multi-mode filter	52
Multi-tap delay	72
Multi-timbral tone generator	ix, 79, 97
MultiSet	viii, 5, 21, 77, 98
Arpeggiator	11, 79
Bank	5
Controller	80
Edit	ix, 21, 77
Effect	22, 28, 81
Maximum polyphony	77
MIDI	79, 80
Note range	78
Output level to the effects	77
Panpot	77
Pitch	82
Pitch bender	82
Play	viii, 5
Program	77
Scale	78, 82
Source	5
Transpose	78
Velocity	78
Volume	77
Mute	8

N

Noise generator	15, 50, 51
-----------------------	------------

O

Octave	11, 31, 62, 78, 84, 90
Omni on/off	86, 98
Organ model	18, 30, 40
Oscillator (OSC)	6, 15, 18, 30, 32
Output	55, 59, 77
Output mode	68, 69, 70, 94

P

Page	13
Page memory	2, 91
Page title	12

Pan	7, 22, 55, 77, 94, 99
Parameter	12
Pedal polarity	xiii, 91
Performance editor	9, 20, 63, 80, 98, 102, 107
Pickup	41, 42, 47
Pitch	31, 47, 50, 78, 90
Pitch bender	6, 31, 82, 99
Pitch offset	24, 84
Plucked string model	19, 30, 45
Polyphonic	60
Portamento	6, 30, 80, 99, 100
Position	90
Pressure	43, 44
Priority order for notes	60
Program	viii, 3, 15, 30, 77, 98
Bank	3
Change	79, 87, 98
Controller	87
Edit	ix
Effect	17, 59
MIDI	86
Panpot	55
Pitch bender	31
Play	viii, 3
Scale	61
Source	4
Transpose	90
Velocity	90

R

Realtime editor	7, 80, 98
Reed breath pressure	43, 44
Reed model	19, 30, 44
Rename	25
Resolution	10
Resonance	7, 16, 53
Resonance OSC	18, 30, 37
Retrigger	60
Ring modulation OSC	18, 30, 39
Rosin	48
Routing	16, 52

S

Save	25, 94, 95
Scale	61, 78, 82
Original	92
Sequencer	97
Smooth bending	42, 44
Sort	23, 83
SPEED	10
Split	ix, 22, 78
Standard OSC	18, 30, 32
Step	23, 84
Strength of playing	45
String position	47
String quality	46, 48
Sub oscillator	15, 50
SW	6, 62, 82
Swap	28, 105
Swing	83
Sync modulation OSC	18, 30, 40

T

Talking modulator 71

Timbre viii, 21, 77

Tone 24, 84

Tone generator 41

Transpose 78, 90, 98

Trigger 35, 41, 60

Trumpet 19, 42

Tune 90

U

Undo 27

Unison 61, 82

User group 4, 26, 61, 92

User pattern 23, 83

Utility 4, 27, 105

V

Velocity 11, 23, 24, 84, 90

Velocity curve 90, 98

Velocity switch ix, 22, 78

Vibrato 6, 31, 99

Violin 48

Volume 19, 22, 51, 55, 77, 93, 99

Volume pedal xiii, 7, 93

VPM OSC 18, 30, 36

W

Wave reflection ratio 49

Wave shape 33, 45

Word clock 93, 109

Write operation 6, 8, 9, 11, 12, 26, 62

X

X-Y HOLD 6

X-Y PAD 6, 20, 80

NOTICE

KORG products are manufactured under strict specifications and voltages required by each country. These products are warranted by the KORG distributor only in each country. Any KORG product not sold with a warranty card or carrying a serial number disqualifies the product sold from the manufacturer's/distributor's warranty and liability. This requirement is for your own protection and safety.

KORG KORG INC.

15 - 12, Shimotakaido 1 - chome, Suginami-ku, Tokyo, Japan.