

dynamic bitimbric synthesizer



owner's manual Page 4

manuale istruzione Pagina 15

mode d'emploi Page 27

12 VOICES, DOUBLE SOUND GENERATION, STEREO, DYNAMIC KEYBOARD, ADVANCED
ON LINE, 2-TRACK REAL TIME POLYPHONIC MIDI SEQUENCER.

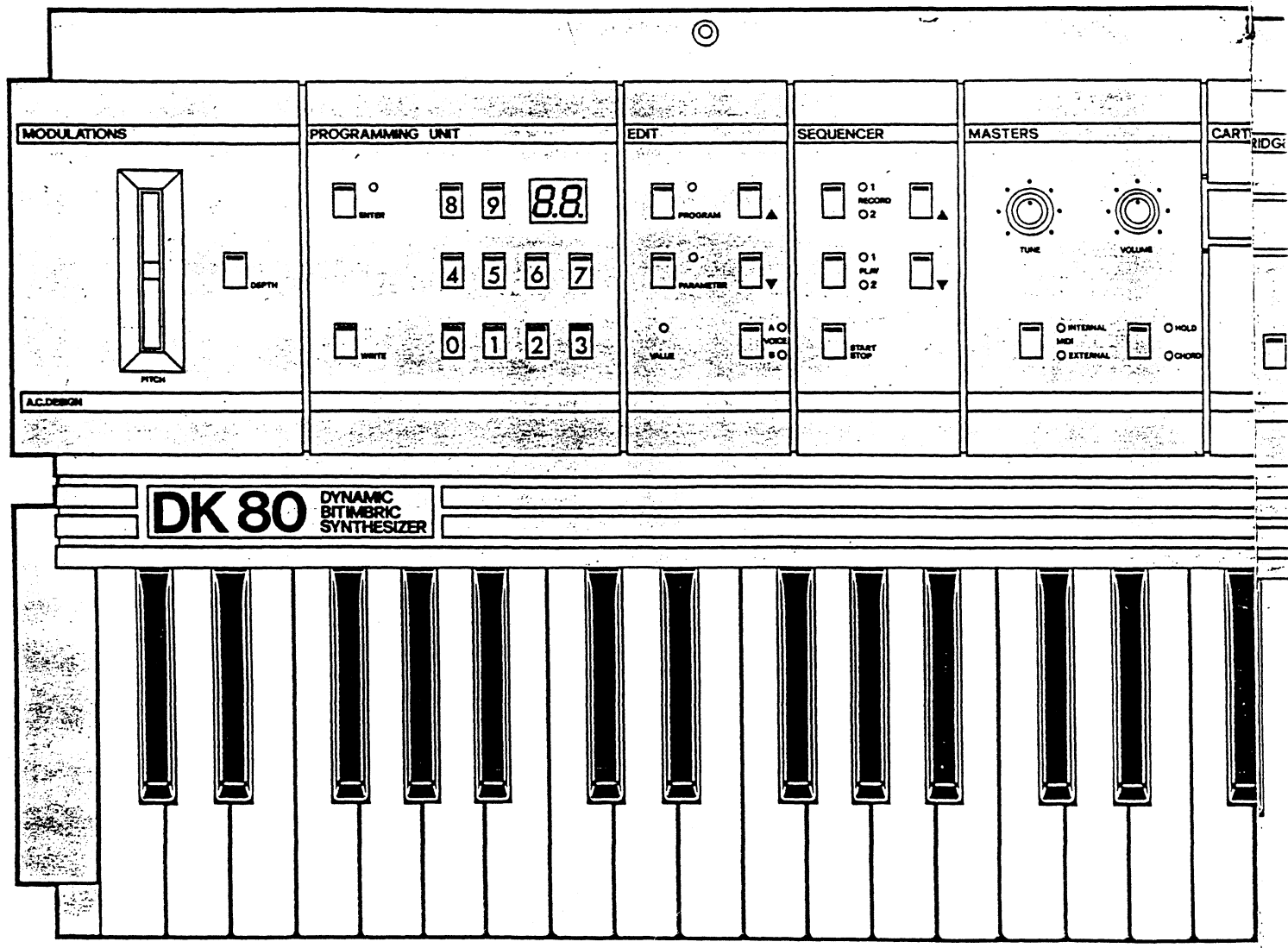

DK 80 DYNAMIC BITUMERIC SYNTHESIZER

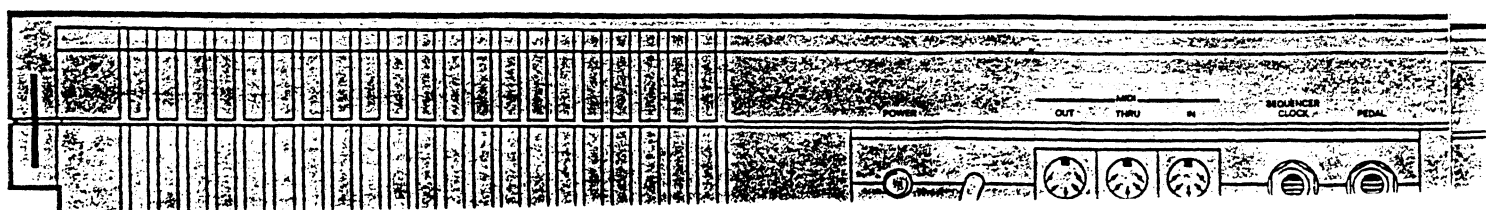

▷ MIDI FUNCTIONS, 87 PROGRAMMABLE PARAMETERS, UP TO 150 PROGRAMS

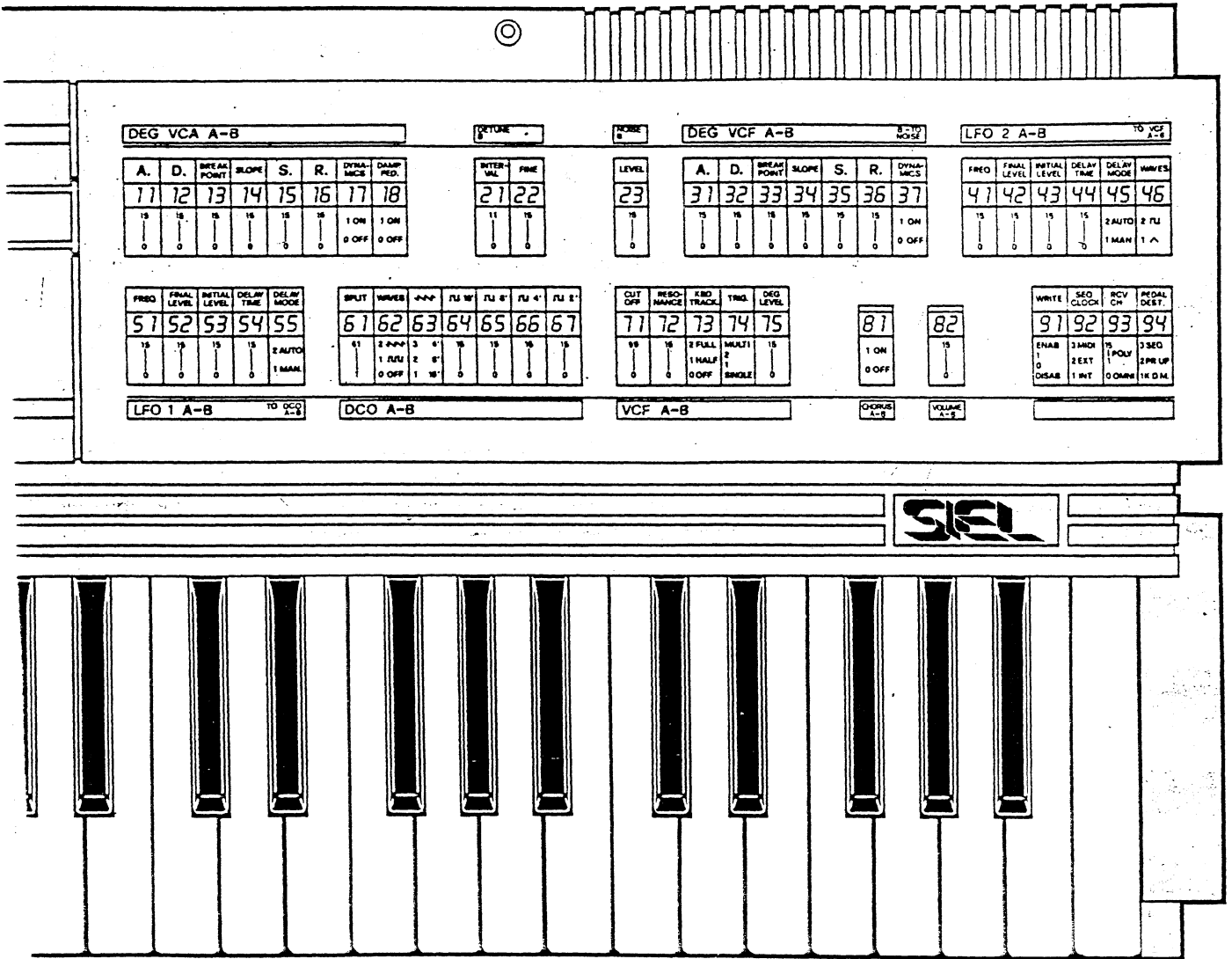

4 INTRODUCTION

The DK-80 is a bi-timbric, polyphonic synthesizer with voice assignment containing 12 complete and individual synth modules (termed voices or channels).

It is fully programmable and able to store up to 50 programs in its computer memory and groups of 50/100 programs in the RAM/ROM packs (additional memories) which can be inserted into the special CARTRIDGE location. The instrument is provided with 12 oscillators (D.C.O.), 1 pink noise generator, 2 24db/octave low pass Voltage Controlled filters (V.C.F.), 14 digital envelope generators (D.E.G.) and 4 low frequency oscillators (L.F.O.) providing parallel modulation of parameters such as pitches and filters.

All this is controlled by specific controls on the EDIT section and memorized in the heart of the DK-80: the PROGRAMMING UNIT. The Programming Unit also controls the 50 factors programs (40 not programmable and 10 programmable) and the 50 or 100 external programs: 50 (programmable) on RAM pack, or 100 (not programmable) on ROM pack. Thus the DK-80 can control up to 150 musical programs simultaneously: 50 internal ones plus 50 (on RAM) or (ROM) external ones which are recalled directly by the PROGRAMMING UNIT.

2. POWER CONNECTION

First check that the line voltage is in accordance with local voltage.

To switch on the DK-80 connect the power cable to the external amplifier. Connect the 1/4" jack MONO OUTPUT to the input of an amplifier for a monophonic connection; for a stereophonic connection connect the 1/4" phone jack A/B OUTPUTS with the inputs of two amplifiers or of a mixer. The instrument may also be connected to stereo headphones through the STEREO PHONES output.

If needed, connect the special optional pedal to the PEDAL input.

Reduce DK-80's and amplifier's master volume knobs to zero. Switch power on to both devices and set their volumes to an acceptable level (usually the instrument's volume should be 3/4 of maximum level).

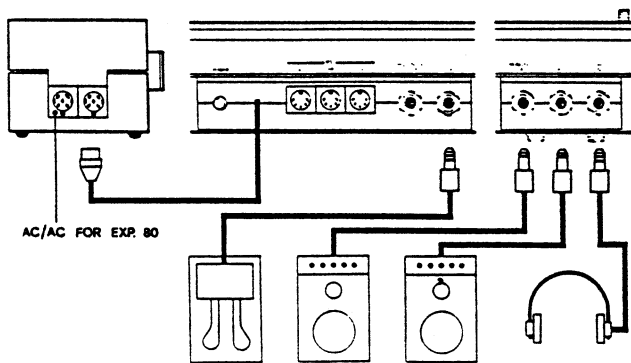

3. PROGRAMMING

3.1 PROGRAM SELECT

On power-up the DK-80 selects the program number corresponding to the last program used (see display). The programs are numbered from 00 through 99; to change over to second program simply digit the number desired on the switch panel and then press ENTER on the PROGRAMMING UNIT. Check that the «PROGRAM» led on the EDIT section is on.

The ENTER function must always follow the new program's data otherwise the display will show the newly recalled program while the instrument is still playing the former one

PROGRAMMING UNIT

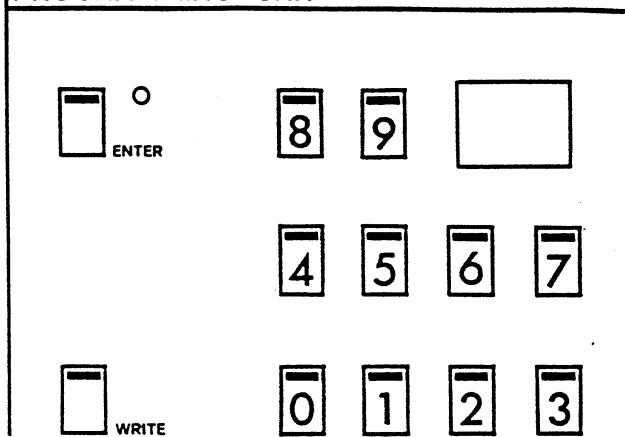

timbre in one of the memories).

The internal programs are numbered from 00 through 49, the external ones from 50 through 99. To recall an external program (either on RAM pack or on ROM pack) you must enable the CARTRIDGE section with the ON switch (LED lights up) and digit the program number (in this case any from 50 to 99). In case an external program is recalled with the CARTRIDGE function disabled (LED off), or without having inserted the CARTRIDGE, the display shows the number of the recalled program, while the instrument starts playing one of the internal programs and precisely the program whose number is obtained subtracting 50 from the number of external program recalled. For example: if you select No. 63, corresponding to an external program, without having inserted a CARTRIDGE or without activating the ON switch, the display will show No. 63 but the instrument will play program No. 13 (63 minus 50). If you use an external additional memory on ROM pack (not programmable) it is possible to recall 100 external programs which will always be identified with numbers from 50 to 99; but you may also form 2 banks of 50 programs each (bank L and bank R).
 - L (both switches to the left position)
 - R (both switches to the right position)

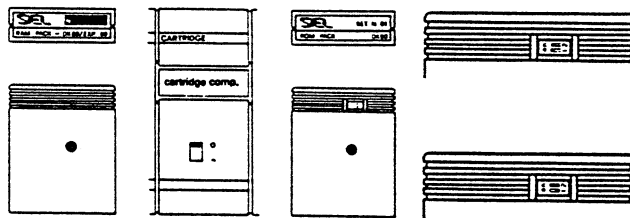

3.2 PROGRAM EDIT

It is possible to edit any program in use (internal from 00 to 49 and external from 50 to 99).

To modify or re-memorize a program is very easy. On the right of the instrument is a table of the controllable parameters.

The parameters are divided into functional groups and for each parameter the following data are specified:

NAME	CUT OFF	RESO-NANCE	KBD TRACK.	TRIG.	DEG LEVEL
NUMBER	71	72	73	74	75
RANGE OF VALUES	99 0	15 0	2 FULL 1 HALF 0 OFF	MULTI 2 1 SINGLE	15 0
SECTION	VCF A-B				

If you wish to change any parameter...

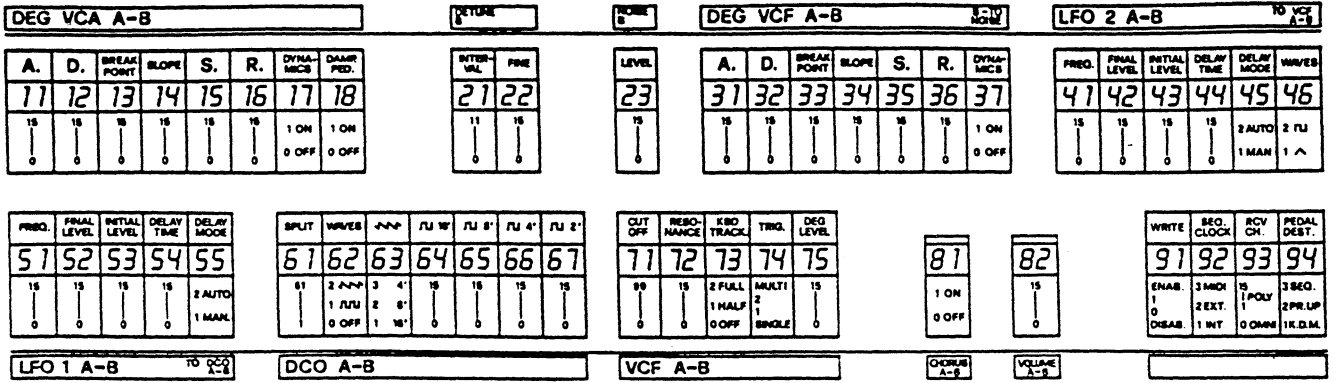

- The parameters relative to the DEG (Digital Envelope Generators) envelopes of the VCA (Voltage Controlled Amplifiers) A and B are numbered from 11 to 18.
- The parameters of the VCF (Voltage Controlled Filters) A and B envelopes range from 31 to 37.
- The parameters of LFO 2 (Low Frequency Oscillators) A and B range from 41 to 46.
- The parameters of LFO 1 A and B range from 51 to 55.
- The parameters of the DCO (Digitally Controlled Oscillators) A and B range from 61 to 67.
- The parameters of VCF A and B range from 71 to 75.
- The CHORUS A and B parameter number is 81.
- The VOLUMES A and B parameter number is 82.

Thus, even if the two digit numbers serve for identification of the parameters of sections A and B, it is possible to programme them independently using the VOICE A-B selector on the EDIT section. In this way you can obtain two completely different sounds to be played either on SPLIT keyboard or one on top of the other from the same key. The oscillator B parameters of DETUNE (No. 21 and No. 22), NOISE (No. 23) and of the non programmable functions (No. 91-92-93-94-95-96) do not depend on the VOICE A-B selector as they cannot be used differently for the two sections.

EXAMPLE:
Select the PARAMETER function; the ENTER LED starts blinking and the display shows the number of the last program selected.

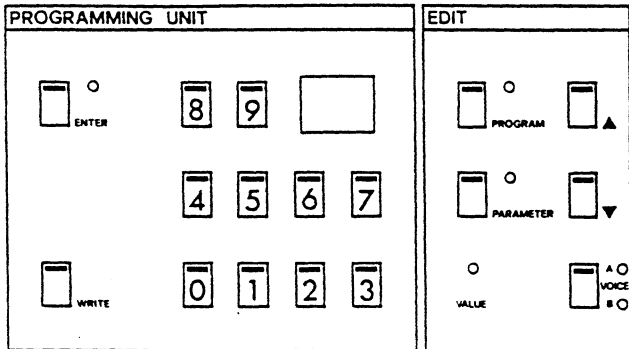

Digit No. 12 corresponding to the VCA A or B decay time parameter;

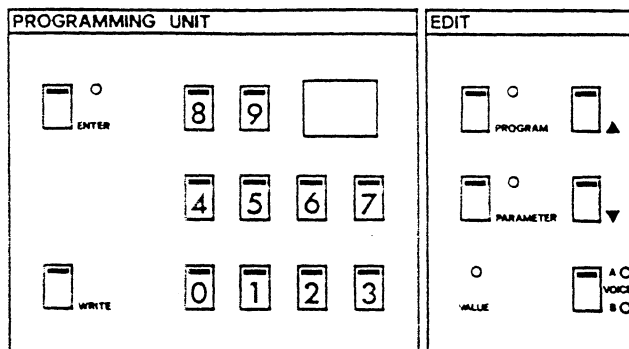

The VOICE A-B selector enables you to set the display to the parameter value referred either to section A or to section B.

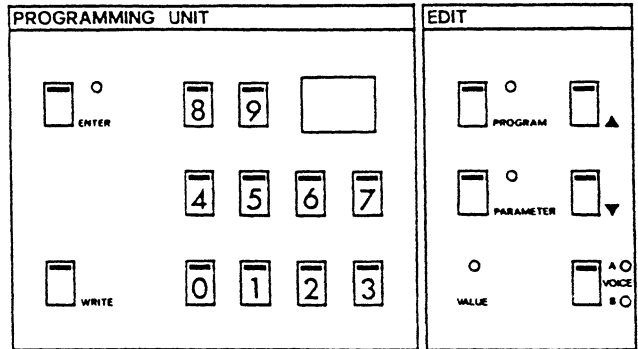

At this point, after selecting section A or B, you may edit the parameter using the tabs. A decimal point on the right of the number appears on display when in EDIT function.

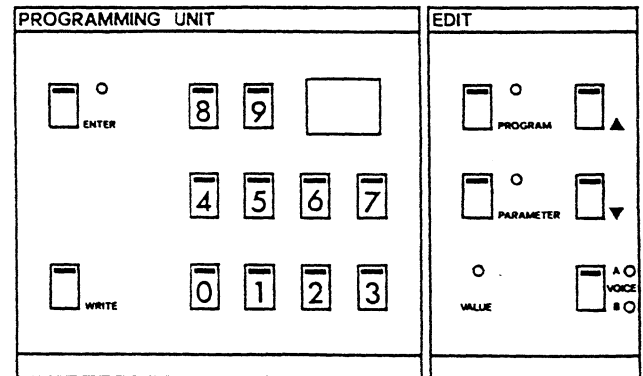

Going back to PROGRAM (press PROGRAM switch - LED lights-up) with EDIT function completed, the ENTER LED starts blinking while the display shows the number of timbre in use.

To cancel changes press ENTER; the original sounds will be recalled from memory and all the values will be re-assigned to the parameters you had altered.

In conclusion, the display can show:

- 1) when in PROGRAM position: the number of program in use;
- 2) when in PARAMETER position: the number of the parameter you wish to edit;
- 3) when in VALUE position: the number of parameter (section A or B) enabled by the ENTER command.

The LED of each option lights-up when the corresponding function is selected (EDIT section).

3.3 PROGRAM RECORD

IMPORTANT: on power-up the DK-80 is not enabled to record new programs.

— SELECT the MIDI INTERNAL function:

- 6 - PRESS the PARAMETER switch (EDIT section);
 - DIGIT No. 91 corresponding to parameter WRITE (see par. 11) and



WRITE PARAMETER

- PRESS ENTER; No. 00 (DISABLE) appears on display;
 - SELECT function 01 (ENABLE) with the tab.
 Now the DK-80 is ready to record new programs. To exit the RECORD phase, switch off the instrument or re-select value 00 following the same operations as described above.

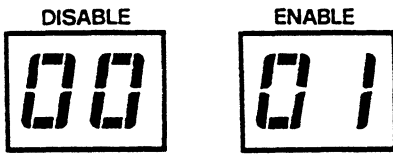

VALUES

- PRESS PROGRAM for visualization of the timbric presets' numbers;
 - RECALL a preset:
 from 00 to 49 or
 from 00 to 99 - only if an additional memory has been inserted into the special CARTRIDGE compartment and the ON switch has been activated (LED lit);
 - PRESS ENTER;
 - SELECT the PARAMETER function; the display shows the parameter numbers;
 - SELECT the number of parameter to be edited, for example No. 71 relative to the filter cutoff;
 - PRESS ENTER; the VALUE LED lights-up and the display shows the parameter's memorized value which, in this case, ranges from 00 to 99 (see parameter table).
 - EDIT the value of section A or B, selected with VOICE A-B, using the tabs.

Now you may also edit other parameters, re-setting to PARAMETER. For example:

- DIGIT No. 23 relative to the parameter which controls the pink-noise;
 - PRESS ENTER;
 - CHANGE, with the tabs, the value shown (in this case from 00 to 15).
 In this way it will be possible for you to modify all the parameters you like until you obtain a completely different timbre.

If you wish to record the new sound, remember that YOU CAN RECORD SOUNDS ONLY:

- TO THE SPACE OF INTERNAL MEMORY FROM 40 TO 49 and
 - TO THE SPACE OF EXTERNAL MEMORY FROM 50 TO 99 only in case a RAM pack (programmable additional memory) has been inserted into the CARTRIDGE compartment and the CARTRIDGE ON switch has been activated (LED lit).
 Should you attempt to record to an internal memory location from 00 to 39 (not programmable memory space), IE (Internal Eprom) will appear on display to stress that the operation is not possible.
 Should you attempt to record to an external memory location from 50 to 99 and a ROM pack (not programmable additional memory) has been inserted, CE (Cartridge Eprom) will



IE= INTERNAL EPROM



CE= CARTRIDGE EPROM

- To record all program changes simply:
 - Press WRITE: DK-80 resets to PROGRAM and the number of the edited program starts flashing on display;

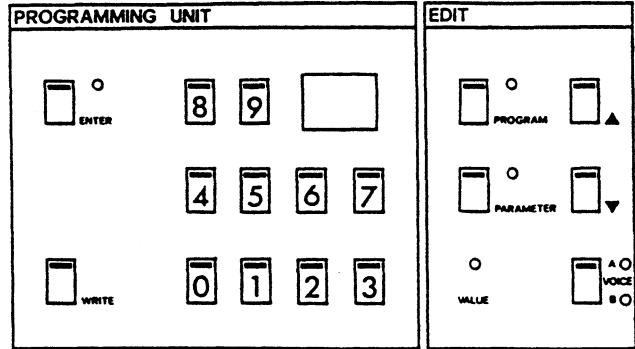

- Select the number of program location to which you wish the new timbre to be transferred;
 - Press ENTER.

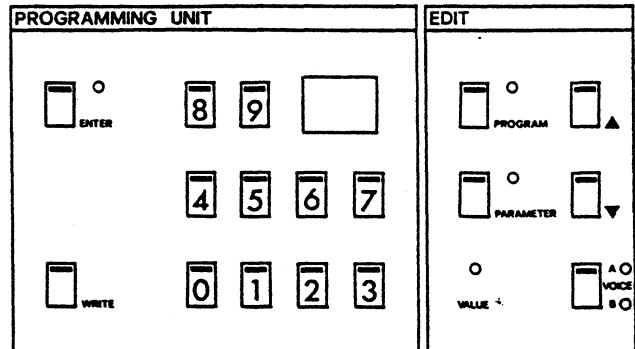

If, for any reason, you wish to exit the record phase before completing it with the ENTER command, simply switch WRITE again; in this way the record function is disabled and the instrument plays the edited program. Switching ENTER the DK-80 resets to its initial position without affecting the program memory.

WARNING

Before recording a program to any memory location, verify that the location is not occupied by a program you wish to keep memorized.

4. SOUND GENERATORS

This section will enable you to generate audio frequencies and/or noises. It contains two digital oscillators (DCO A-DCO B) which generate a saw-tooth wave at 16' - 8' - 4' and a square wave at 16' - 8' - 4' - 2'. The parameters corresponding to DCO A-B are No. 61-62-63-64-66-67. There is also a pink-noise generator (NOISE) whose parameter is No. 23.

NOISE B

LEVEL

23

15
|
0

If the square wave is selected, parameters 64-65-66-67 adjust the volume of each octave so as to create the desired harmonic composition:

SPLIT	WAVES	锯齿	方 16'	方 8'	方 4'	方 2'
61	62	63	64	65	66	67
61 1	2 锯齿 1 方 0 OFF	3 4' 2 8' 1 16'	15 0	15 0	15 0	15 0

4.2 D.C.O. (A-B)

SPLIT	WAVES	锯齿	方 16'	方 8'	方 4'	方 2'
61	62	63	64	65	66	67
61 1	2 锯齿 1 方 0 OFF	3 4' 2 8' 1 16'	15 0	15 0	15 0	15 0

DCO A-B

parameter No. 64 adjusts the volume of 16' from 0 to 15
parameter No. 65 adjusts the volume of 8' from 0 to 15
parameter No. 66 adjusts the volume of 4' from 0 to 15
parameter No. 67 adjusts the volume of 2' from 0 to 15.
The octave selectors transpose oscillators A-B from a minimum of 32.7 Hz (first C - 16') to a maximum of 7902 Hz (last B but one - 2'). The correct pitch for A = 440 Hz will be achieved with the master TUNE knob (MASTERS section).

4.2.3 SPLIT

Parameter 61 determines the part of keyboard from which generators A and B should play. Its values, ranging from 00 to 61 like to keyboard extension, control:
- section A: the right part, thus determining the point up to which generator A will play;
- section B: the left part, thus determining the point from which generator B will start playing.
With parameter set to value 00, generator A is disabled.
With parameter set to value 61, generator B plays on the whole keyboard extension.

4.2.1 WAVES

Parameter No. 62 enables selection of the type of wave-form you wish to use (SQUARE or SAW-TOOTH) for section A and/or B. Remember that in case you select a square wave, corresponding to value 01, parameter No. 63 which controls the saw-tooth wave (not selected) will not be enabled and if recalled its number will not appear on display.

If you select a saw-tooth wave, corresponding to value 02, parameters 64-65-66-67 which control the square wave (not selected) will not be enabled and if recalled their numbers will not appear on display.

In case you select value 00 (wave-forms OFF no wave-form selected) parameters 63-64-65-66-67 will not be enabled, thus the relative numbers will not appear on display.

The WAVES selector enables:

- the saw-tooth wave to enter the VCF/VCA section and the audio output. The saw-tooth wave contains all harmonics with an amplitude which is directly proportional to the number of the harmonic itself;

- the square wave to enter the VCF-VCA section and the audio output. The harmonic content of each footage value (16' - 8' - 4' - 2') is composed of odd harmonics only.

When neither waveform is selected, no signal is addressed to the VCF/VCA section and audio output.

4.2.2 FOOTAGE SELECTION

If the saw-tooth wave is selected, parameter No. 63 adjusts its footage with the following values:

- 1 = 16'
- 2 = 8'
- 3 = 4'

SPLIT	WAVES	锯齿	方 16'	方 8'	方 4'	方 2'
61	62	63	64	65	66	67
61 	2 锯齿 1 方	3 4' 2 8'	15 	15 	15 	15

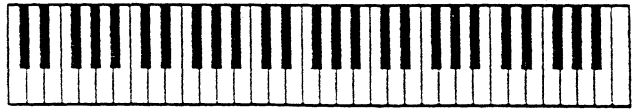

With parameter set to value 61, generator A plays on the whole keyboard extension.
With parameter set to value 61, generator B is disabled.

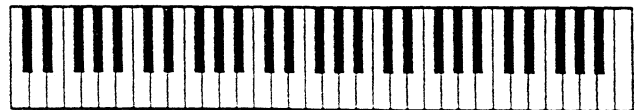

To achieve an "all keyboard" situation with both generators enabled simply set parameter No. 61 to the following values:
A = 61
B = 00



To obtain any split point, select the desired key number (from 00 to 61) and assign it to the two sections. For example, with values A = 30 and B = 30 you will have a split point corresponding approximately to the centre of the keyboard.

8 It is also possible to play one timbre on one part of the keyboard and a different timbre on the other and obtain the total of the two in the middle section. To achieve this type of «OVERLAY» split assign to voice A, for example, the SPLIT value 40 (so that it will play up to key 40) and to voice B the SPLIT value 20 (so that it will play from key 21). In this way voice A will play on the left part of the keyboard up to key No. 40, while voice B will play on the right part to start from key No. 21. The total of A + B will play on the part of keyboard from Key No. 21 to key No. 40.



4.3. DETUNE B

DETUNE B	
INTERVAL	FINE
21	22
11	15
0	0

Controls the pitch of the second oscillator with respect to the first. This function is adjusted by parameters 21 (INTERVAL) and 22 (FINE).

4.3.1 INTERVAL

Controls the pitch of the second oscillator with respect to the first for a frequency interval of 11 semitones up. This function is regulated by parameter No. 21 with values ranging from 00 to 11.

4.3.2 FINE

Controls the fine pitch of the second oscillator with respect to the first for a frequency interval of 1/4 tone down. This function is regulated by parameter No. 22 whose values range from 00 to 15.

RELATION BETWEEN WAVEFORMS AND SOUNDS

The selection of sound waves provides set-up of the synth basic timbre for the creation of different groups of instruments. For example, the saw-tooth wave () which contains odd and even harmonics will be useful to generate strings and brass instrument sonorities. The square wave () will be useful to create timbres such as the clarinet. The audible differences between waves depend on their different harmonic content. A complex sound (square wave, saw-tooth wave, etc.) is the total of pure sounds (sine waves) in which the basic note (note which determines the pitch) has a single amplitude, and all the others (called harmonic notes) have a different amplitude depending on the harmonic spectrum of the complex wave analyzed.

5. V.C.F. A-B (Voltage

This section is controlled by parameters 71-72-73-74-75

CUT OFF	RESONANCE	KBD TRACK.	TRIG.	DEG LEVEL
71	72	73	74	75
99	15	2 FULL 1 HALF 0 OFF	MULTI 2 1 SINGLE	15
0	0			0

VCF A-B

5.1 CUTOFF

The parameter which controls the CUTOFF is No. 71 (00-99). It adjusts cutoff frequency of the 24dB/octave (4 pole) Low-Pass filter. It is rather a tone control. «Cutoff» is the frequency below which all elements of the mixer's output signal are let through. The higher frequency components of the input signal (i.e. all those above the cutoff frequency) are suppressed. The higher the control setting, the higher the frequencies are which pass through the filter. Thus, the higher the sound. With cutoff tuned on the same frequency as the basic note, you obtain the formation of an almost sine wave (pure wave with no harmonic content). Frequency cutoff set to 0 means no sound output at all.

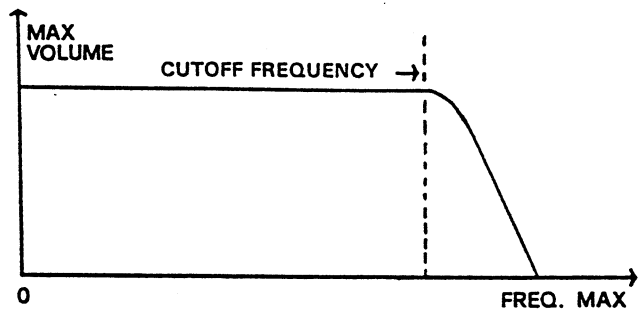

5.2. RESONANCE

The RESONANCE («EMPHASIS», «REGENERATION», or «Q») adjusts the amount of filter resonance and raises the frequency region round the cutoff, thus increasing the harmonic content of that region. The higher the resonance, the more «nasal» the sound.

This function is controlled by parameter No. 72 with values from 00 to 15.

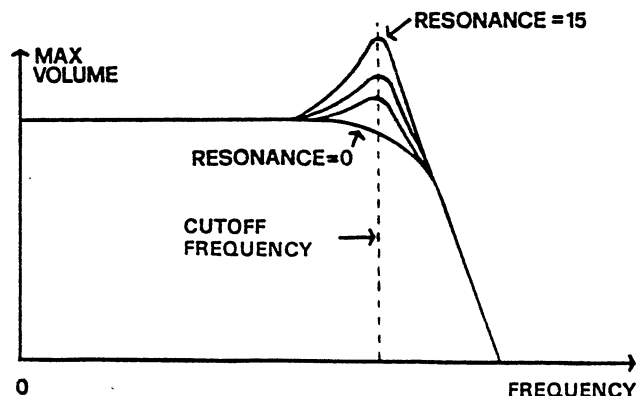

5.3 KEYBOARD TRACKING

When on, the keyboard voltage control applies to the filter frequency cutoff. This «interaction» of the Well-Tempered scale on the filter makes it possible to obtain a changeable consistency of timbre over the whole keyboard range. This function is controlled by parameter No. 73 whose values 0-2 refer respectively to:

5.4. TRIGGER

The DK-80 contains 2 filters, one for section A the other for section B. When you play in polyphonic mode, the A.D.B.S.S.R. of the filter follows only the first note played in modo mode. The TRIGGER function, controlled by parameter No. 74 with values 1 (SINGLE) and 2 (MULTIPLE), enables you to choose whether to keep the A.D.B.S.S.R. of the filter on the first note only or repeat it on all notes played.

5.5. DEG LEVEL

It determines the DEG (Digital Envelope Generator) level on the filter. With AMOUNT set to 00, the envelope has no effect on the filter. This function is controlled by parameter No. 75 whose values range from 00 to 15.

6. DYNAMICS A.D.B.S.S.R. (Envelope Generators)

The envelope generators A.D.B.S.S.R. apply to the A-B sections of VCF and VCA through the ATTACK, DECAY, BREAK POINT, SLOPE, SUSTAIN and RELEASE controls. The envelope voltage generated by the 6 stages (A-D-B-S-S-R) may be used to change a timbre over time (operating VCF) or to modify an amplitude over time (operating VCA). The envelope function is initiated when a key is struck (each note has its individual envelope in VCA, while the envelope is the same for all notes in VCF) and proceeds through its attacks, decay and slope periods at a rate determined by the setting of the relative parameters. The sustain level of each note will remain at the level set by SUSTAIN until the key is released. When the key is released, the RELEASE function is activated and proceeds at a rate determined by its own parameter value setting.

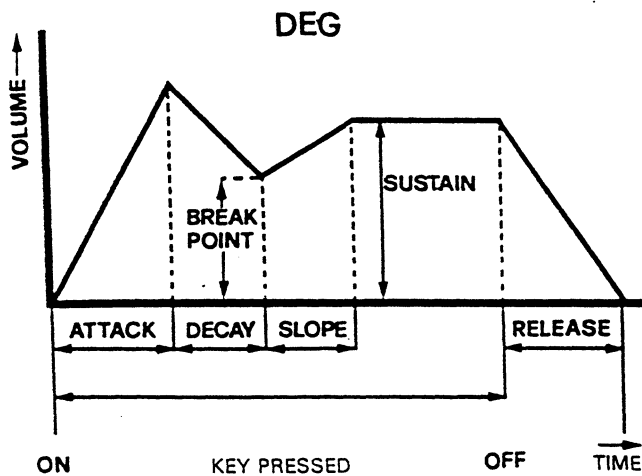

The DEG (Digital Envelope Generators) parameters of VCA sections A-B are numbered from 11 to 18.

The DEG parameters of VCF sections A-B are numbered from 31 to 37.

6.1 DEG VCA A-B

DEG VCA A-B							
A.	D.	BREAK POINT	SLOPE	S.	R.	DYNA-MICS	DAMP. PED.
11	12	13	14	15	16	17	18
15 ↑ 0	15 ↑ 0	15 ↑ 0	15 ↑ 0	15 ↑ 0	15 ↑ 0	1 ON 0 OFF	1 ON 0 OFF

function is adjusted by parameter No. 11 with values ranging from 00 to 15.

6.1.2 DECAY

Adjusts the length of time for the amplifier of each A-B voice to go back from maximum level (achieved after the attack stage) to BREAK POINT LEVEL. If BREAK POINT value is set to 00, the DECAY will fall from maximum level to zero level. If the Break Point is set to the maximum, DECAY will have no effect. This function is controlled by parameter No. 12 with values from 00 to 15.

6.1.3 BREAK POINT

Determines the level at which the amplifier's DECAY of each A-B voice must stop. This is a level control, not a time control like ATTACK, DECAY, and RELEASE. It is adjusted by parameter No. 13 whose values range from 00 to 15.

6.1.4 SLOPE

Determines the rate at which the envelope contour moves from the BREAK POINT level to the SUSTAIN level of the amplifier or each A-B voice. It can be either descending, thus functioning as a second decay, or ascending, to function as a second attack.

The SUSTAIN level determines the SLOPE. If the SUSTAIN level is higher than the BREAK POINT level, the SLOPE will rise and function as a second attack, while if it is lower the SLOPE will decrease acting as a second decay. The slope function is controlled by parameter No. 14 with values ranging from 00 to 15.

6.1.5 SUSTAIN

Determines the level which the SLOPE function should reach. In case the SUSTAIN value corresponds to the BREAK POINT value, the SLOPE has no effect. The SUSTAIN, like the BREAK POINT, is a level control and has no connection whatsoever with time. (ATTACK, DECAY and RELEASE are time controls).

This function is adjusted by parameter No. 16 with values from 00 to 15.

6.1.6 RELEASE

Adjusts the length of time for the amplifier of each A-B voice to go back from Sustain level to zero after the key has been released. If the key (or keys) is released before the Attack, Decay or Slope periods have elapsed, the RELEASE control determines the time taken for the amplifier of each A-B voice to drop to zero from their level when the key was released. If the Sustain level is set to 00 and the Attack, Decay, Slope periods have elapsed, the RELEASE setting is irrelevant, because there is no level for the amplifier to release from. This function is regulated by parameter No. 16 with values from 00 to 15.

6.1.7 DYNAMICS

The keyboard is controlled by a microprocessor which constantly reveals the speed at which the keys are struck, which is directly proportional to touch. This data is used to adjust the «feeling» of a performance, the amplitude of the filters and/or amplifiers of the notes.

This function is adjusted by parameter No. 17 and activates the keyboard dynamic control on the maximum amplitude of the DEG V.C.A. A-B. The volume will vary depending on the touch.

6.1.8 DAMPER PEDAL (optional)

Enables the envelope automatic function. With parameter No. 18, using the special pedal, it is possible to run across the Attack, Decay, Break Point, Slope, Sustain phases even if the keys are released before their periods have actually elapsed.

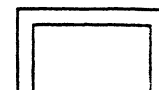

6.2. DEG VCF A-B

DEG VCF A-B						B-TO NOISE
A.	D.	BREAK POINT	SLOPE	S.	R.	DYNA-MICS
31	32	33	34	35	36	37
15 0	15 0	15 0	15 0	15 0	15 0	1 ON 0 OFF

6.2.1 ATTACK

Adjusts the length of time for the filters of the first voice played on the A-B section to go from 0 level (when one or more keys are initially pressed) to maximum level.

This function is adjusted by parameter No. 31 with values ranging from 00 to 15.

6.2.2. DECAY

Adjusts the length of time for the filter of the first voice played on the A-B section to go back from maximum level (achieved after the attack stage) to BREAK POINT level. If the BREAK POINT is set to 00, the DECAY will go from maximum level to zero level.

If BREAK POINT is set to the maximum, DECAY will have no effect. This function is adjusted by parameter No. 32 with values from 00 to 15.

6.2.3 BREAK POINT

Determines the level at which the filter's DECAY must stop. This is a level control, not a time control like ATTACK, DECAY and RELEASE. This function is controlled by parameter No. 33 whose values range from 00 to 15.

6.2.4 SLOPE

Determines the rate at which the envelope contour moves from the BREAK POINT level to the SUSTAIN level of the filters of sections A and B. It can be either descending, thus functioning as a second decay, or ascending, to function as a second attack. The SUSTAIN level determines the SLOPE. If the SUSTAIN is higher than the BREAK POINT level, the SLOPE will rise and function as a second attack, while if it is lower the SLOPE will decrease and function as a second decay. The SLOPE function is controlled by parameter No. 34 whose values range from 00 to 15.

6.2.5 SUSTAIN

Determines the level which the SLOPE function should reach. In case SUSTAIN and BREAK POINT are set to the same value, SLOPE has no effect. The SUSTAIN, like the BREAK POINT, is a level control and has no connection with time (ATTACK, DECAY, RELEASE are time controls). This function is controlled by parameter No. 35 (00-15).

6.2.6 RELEASE

Determines the length of time for the filters of section A-B to fall from SUSTAIN level to zero after the key is released. If the key (or keys) is released before the Attack, Decay or Slope periods have elapsed, the RELEASE control determines the time taken for the filter of each A-B voice to drop to zero from their level when the key was released. If the SUSTAIN level is set to 00 and the Attack, Decay, Slope periods have elapsed, the RELEASE setting is irrelevant, because the is no level for the filter to release from. This function is regulated by parameter No. 36 with values ranging from 00 to 15.

6.2.7 DYNAMICS

The keyboard is controlled by a microprocessor which constantly reveals the speed at which the keys are struck,

the keyboard dynamic control on the maximum amplitude of the DEG (Digital Envelope Generator) V.C.F. A-B. The volume will vary depending on the touch.

7. L.F.O. (Low Frequency Oscillators)

This section comprises 4 low frequency oscillators which make it possible to obtain modulations of parameters such as the independent pitches of oscillators A and B and the independent VCF of sections A-B.

7.1 L.F.O. 1 A-B

FREQ.	FINAL LEVEL	INITIAL LEVEL	DELAY TIME	DELAY MODE
51	52	53	54	55
15 0	15 0	15 0	15 0	2 AUTO 1 MAN.

LFO 1 A-B	TO DCO A-B
-----------	------------

This section contains two sub-audio oscillators which can be controlled separately with parameters of depth (INITIAL LEVEL - FINAL LEVEL), rate (FREQUENCY), delay time (DELAY TIME) and manual/automatic control (DELAY MODE). The destinations of these triangle oscillators are respectively: the first for oscillator A, the second for oscillator B. If you address LFO 1 A-B modulation source to one of the two audio-oscillators or to both, you will obtain a periodic pitch variation known as VIBRATO.

7.1.1 FREQUENCY

Adjusts the modulation rate of oscillators LFO 1 A and LFO 1 B. This function is controlled by parameter No. 51 with values from 00 to 15.

7.1.2 FINAL LEVEL

Adjusts the amplitudes that LFO 1 A-B will take on as final value-either after the attack delay (DELAY TIME) if DELAY MODE is in AUTO position, or after pressing the DEPTH tab if DELAY MODE is in MAN. Position.

This function is controlled by parameter No. 52 with values from 00 to 15.

7.1.3 INITIAL LEVEL

Adjusts the amplitude that LFO 1 A-B will take on as initial value either after the attack delay (DELAY TIME) when DELAY MODE is in AUTO, or after pressing the DEPTH tab when DELAY MODE is in MAN. This function is controlled by parameter No. 53 with values from 00 to 15.

These controls enable you to obtain effects whose modulations: a) start as soon as the key is struck and stop with a pre-arranged delay, or b) start only with a certain delay, or c) even change their intensity after a pre-arranged delay determined by the DELAY TIME command.

7.1.4 DELAY TIME

When DELAY MODE is in AUTO position, it adjusts the length of delay with which the LFO 1 A-B should take on the final level. This function is controlled by parameter No. 54 whose values range from 00 to 15.

7.1.5 DELAY MODE

Selects the type of delay, which may be manual or automatic, of the final level. When in MANUAL position the

LFO 2 A-B					TO VCF A-B
FREQ.	FINAL LEVEL	INITIAL LEVEL	DELAY TIME	DELAY MODE	WAVES
41	42	43	44	45	46
15 0	15 0	15 0	15 0	2 AUTO 1 MAN	2 Π 1 ^

This section contains two sub-audio oscillators which can be controlled separately with parameters of depth (INITIAL LEVEL - FINAL LEVEL), rate (FREQUENCY), delay time (DELAY TIME), manual/automatic control and type of wave-form (WAVES). The addresses of these oscillators are respectively: the first for the filter of section A, the second for the filter of section B. Addressing the L.F.O. 2 A-B modulation source to one of the two audio-oscillators or to both, you will obtain a periodic pitch variation, known as VIBRATO.

7.2.1 FREQUENCY

Adjusts the modulation rate of oscillators LFO 2 A and LFO 2 B. This function is controlled by parameter No. 41 with values from 00 to 15.

7.2.2 FINAL LEVEL

Adjusts the amplitudes that LFO 2 A-B will take on as final value - either after the attack delay (DELAY TIME) when DELAY MODE is in AUTO position, or after pressing the DEPTH tab, if DELAY MODE is in MAN. position. This function is controlled by parameter No. 42 with values ranging from 00 to 15.

7.2.3 INITIAL LEVEL

Adjusts the amplitudes that LFO 2 A-B will take on as initial value - either after the attack delay (DELAY TIME) when DELAY MODE is in AUTO position, or after pressing the DEPTH tab, if DELAY MODE is in MANUAL position. This function is controlled by parameter No. 43 with values from 00 to 15.

7.2.4 DELAY TIME

When DELAY MODE is in AUTO position, it adjusts the length of DELAY with which the LFO 2 A-B should take on the final level. This function is controlled by parameter No. 44 whose values range from 00 to 15.

7.2.5 DELAY MODE

Selects the type of delay, which may be manual or automatic, of the final level. When in MANUAL position, the modulation final level is enabled manually pressing the DEPTH tab. This function is controlled by parameter No. 45 with values 1-MAN; 2-AUTO.

7.2.6 WAVES

Control enabling you to select a triangle wave or a square wave. If you select a triangle wave, you will obtain a periodic linear modulation (first increasing then decreasing) with no discontinuity points. If you select the square wave, you will obtain a periodic square wave modulation.

8. CHORUS A-B

81

1 ON

0 OFF

CHORUS
A-B

The DK-80 is provided with 2 DELAY LINES for CHORUS modulation effects. Enabling this parameter for one of the two sections or for both, you will obtain a timbric effect similar to two instruments playing at the same time, slightly out of tune with each other. This function is regulated by parameter No. 81 whose values are 00 and 01.

9. VOLUME A-B

82

15
|
0

VOLUME
A-B

Programmable volume control for sections A and B. It is determined by parameter No. 82 with values ranging from 00 to 15 and controls the level between the two sections. It can also program the total level of acoustic output so as to obtain the same volume for all presets.

10. MASTERS

MASTERS controls are not programmable.

10.1 VOLUME

Adjusts general volume.

10.2 TUNE

General pitch control (shifts keyboard up or down by about 1 semitone) to tune DK-80 to other instruments.

MASTERS



11. WRITE

WRITE
91
ENAB.
1
0
DISAB.

This parameter is not programmable. It enables or disables the 'save' function (which protects programs from possible operation errors). This function is controlled by parameter No. 91 with values 00 (DISABLE) and 01 (ENABLE).

12. SEQUENCER CLOCK

SEQ. CLOCK
92
3 MIDI
2 EXT.
1 INT.

The DK-80 comprises a 2 track polyphonic Sequencer (see par. 18). The SEQUENCER CLOCK makes it possible for you to select the type of clock you wish to use to record your notes sequences:

- 1) INTERNAL: the DK-80 records and/or reads your sequences by its built-in clock (96 beats per bar - 24 for each quarter). In this case the recording and/or reading speed is adjusted with the tabs (SEQUENCER section);
- 2) EXTERNAL: the DK-80 reads your notes sequences by an external clock originating from an analogue source (Trigger of another sequencer or Trigger of electronic drums);
- 3) MIDI: the instrument reads your notes sequences by an external clock originating from a MIDI source (electronic drums MIDI output).

These functions are controlled by parameter No. 92 whose values are 1 (INTERNAL) - 2 (EXTERNAL) - 3 (MIDI).

13. RCV CH (Receive Channels)

RCV CH.
93
15
1 POLY
1
0 OMNI

You have the possibility of selecting the MIDI reception channels of your instrument. In case the DK-80 is connected for MIDI transmission (see par. 17) and receives external notes, you may select up to 16 different receive channels. In this way, in case of transmission with several channels, DK-80 receives only the notes and the data in which you are

MIDI channels, one to section A the other to section B. For example:

- A) selecting 01 section A will have MIDI channel 0 and section B MIDI channel 1;
- B) selecting 02 section A will have MIDI channel 1 and section B MIDI channel 2 and so on up to value 10, where section A will have MIDI channel 9 and section B MIDI channel 10.

From position 11 to 15 the assigned MIDI channels will be the same for both sections, thus enabling you to receive the composed timbres to the same channel. For example:

- A) selecting 11 both sections A and B will have channel 11, and so on up to channel 15.

14. PEDAL DEST. (left pedal destination)

PEDAL DEST.
94
3 SEQ.
2 PR.UP
1K.D.M.

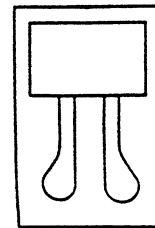

The pedal located on the left of the optional pedal set may be used to accomplish several functions. You may use it to function as:

- A) Sequencer START/STOP both in the record and in the playback phases;
- B) PROGRAM UP to advance the timbric programs;
- C) KEY DATA TO MIDI to set-off or stop the data transmission (only notes) to an expander or keyboard.

This function is visualized by the MIDI INTERNAL/EXTERNAL LEDs (MASTERS section). When DK-80 is in the transmission phase, the LEDs (the first, the second or both) should light-up. When the KEY DATA TO MIDI pedal is pressed and the data transmission (only notes) stops, the LEDs (the first, the second or both) start blinking. All the functions of the left programmable pedal are controlled by parameter No. 94 which has the following values:

- 1 KEY DATA TO MIDI
- 2 PROGRAM UP
- 3 SEQUENCER START/STOP

There are also another two parameters, which do not appear on the parameter table: No. 95 and No. 96.

15. SEQUENCER INTERNAL/EXTERNAL

You may use your musical performance sequences playing them from the DK-80 or sending them to an expander or keyboard, thus leaving your synthesizer free for other executions.

This function is controlled by parameter No. 95 whose values are 00 (INTERNAL) and 01 (EXTERNAL).

16. METRONOME ON/OFF

With Sequencer clock in INTERNAL (parameter No. 92 set to 01) you will be able to follow a metronome in order to compose your performances with a precise rhythmic division. This function is activated by parameter No. 96 with values 00

17. HOLD - CHORD

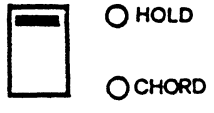

The HOLD - CHORD switch (MASTERS section) serves for instant memorization of notes or for the composition of one finger chords.

HOLD: selecting HOLD, notes played will continue sounding also after the keys are released.

CHORD: if after memorizing the notes in HOLD you switch over to CHORD, a chord will be composed on each new note played in accordance with the previously memorized interval. **EXAMPLE:** play a triad (common chord - C-E-G) and at the same time select HOLD. The instrument will continue playing the common chord with the envelope assigned to the specific sound you have selected.

Select CHORD; the instrument will stop playing the common chord which will now be composed on the notes you play every time you press a key. Selecting CHORD after storing into HOLD memory a single note, the DK-80 plays in MONO mode. To exit HOLD or CHORD simply switch the selector to its off position.

18. SEQUENCER

The DK-80 includes a 2-track real-time polyphonic sequencer which can store up to 300 notes. The real-time memorization gives you the possibility of playing normally, as if you were recording to any audio-recorder.

The sequencer quantization results in 96 clock beats for each 4/4 bar, i.e. each quarter note is quantized in 24 clock beats.

To record a musical quarter proceed as follows:

- Verify the sequencer clock is in INTERNAL position (see par. 12)
- Verify the sequencer output is in INTERNAL position (see par. 15)
- Choose whether you want the metronome to be introduced or not (see par. 16).

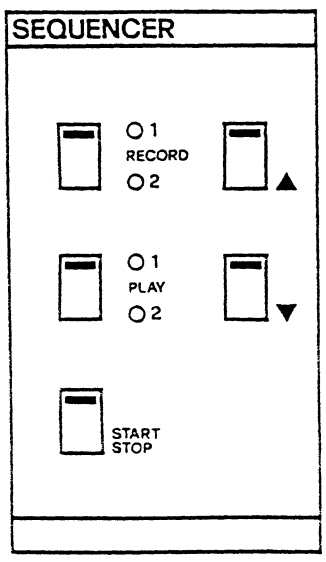

Now select tracks 1 and 2 (RECORD tab) simultaneously to ensure complete memory erase. The LEDs start blinking and the metronome, if activated, stresses the musical quarters. In case you have selected the metronome function, you may adjust the record speed using the tabs (SEQUENCER section), otherwise the record rate will be adjusted automatically. At this point you can enable the record phase pressing either the START/STOP switch or the left optional pedal (SEQUENCER START/STOP position - see par. 14). The LED of the SEQUENCER

or the left pedal (SEQUENCER START/STOP pos.); the recorded sequence will be automatically played back. **PLAY** is automatically selected for track 1. Now you may record also on the second track available. Stop the **PLAY** function with the START/STOP tab then select **RECORD** on track 2. Selecting **PLAY** for track 1 makes it possible to play-back at the same time the first track you had recorded. Remember that as soon as you start recording (after pressing the START/STOP switch or the left pedal when in SEQUENCER START/STOP pos.), DK-80 memorizes all events, including pauses.

To record one or more notes on the first bar beat, simply keep them pressed before entering the record phase (i.e. before pressing the START/STOP switch/pedal). Keep in mind that the sequencer memory can be used totally either for track 1 or for track 2, thus limiting the next over-recording. This is why we recommend that every time you start a new sequence you select both tracks.

Once the record phase is over, DK-80 automatically selects the **PLAY** function (play back) and keeps playing back the recorded musical phrases (LOOP). In case you have used the whole memory space the instrument exits the record phase and the LEDs go off automatically, but the playback function is not automatically enabled.

Pressing **PLAY** the recorded pieces will be played back, but they will not be looped.

19. M.I.D.I. (Musical Instrument Digital Interface)

The DK-80 features a universal interface system used in several applications. The instrument actually communicates with - and is prepared to receive data from - other M.I.D.I. equipped devices. It is possible to make different instruments all play from one keyboard, or to connect your synth to a personal computer, to a poly sequencer, etc. With the **MODE** switch you can select the **INTERNAL**, **EXTERNAL**, **INTERNAL/EXTERNAL** functions in order to communicate and or receive possible program changes. If you want to play two synths through M.I.D.I., connect the MIDI input (IN) of one synth to the MIDI output (OUT) of the other one, and vice-versa.

Now the two instruments are interconnected, ready to communicate with each other and transmit the notes you will play on one of the two keyboards. If you set the DK-80 **MODE** switch to **EXTERNAL** it will be possible for you to change the other synth's program and receive program changes through the commands of the other instrument; setting it to **INT/EXT** you can change both instrument's programs simultaneously.



20. M.I.D.I. CONNECTIONS

The following diagrams show the most common basic connections:

MIDI SYNTH + EXPANDER

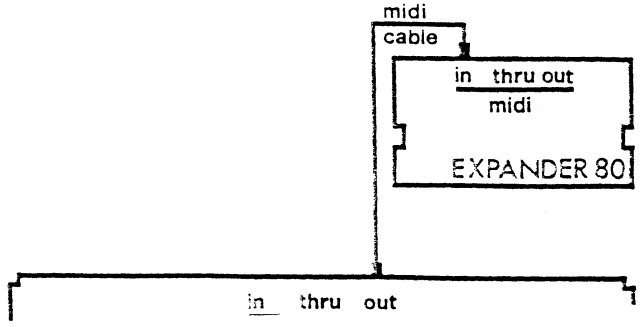

17. HOLD - CHORD

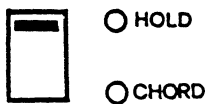

The HOLD - CHORD switch (MASTERS section) serves for instant memorization of notes or for the composition of one finger chords.

HOLD: selecting HOLD, notes played will continue sounding also after the keys are released.

CHORD: if after memorizing the notes in HOLD you switch over to CHORD, a chord will be composed on each new note played in accordance with the previously memorized interval. **EXAMPLE:**

play a triad (common chord - C-E-G) and at the same time select HOLD. The instrument will continue playing the common chord with the envelope assigned to the specific sound you have selected.

Select CHORD; the instrument will stop playing the common chord which will now be composed on the notes you play every time you press a key. Selecting CHORD after storing into HOLD memory a single note, the DK-80 plays in MONO mode. To exit HOLD or CHORD simply switch the selector to its off position.

18. SEQUENCER

The DK-80 includes a 2-track real-time polyphonic sequencer which can store up to 300 notes. The real-time memorization gives you the possibility of playing normally, as if you were recording to any audio-recorder.

The sequencer quantization results in 96 clock beats for each 4/4 bar, i.e. each quarter note is quantized in 24 clock beats.

To record a musical quarter proceed as follows:

- Verify the sequencer clock is in INTERNAL position (see par. 12)
- Verify the sequencer output is in INTERNAL position (see par. 15)
- Choose whether you want the metronome to be introduced or not (see par. 16).

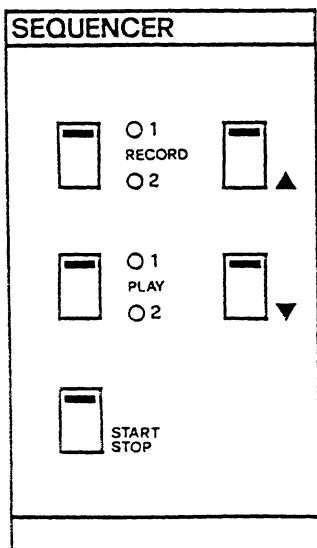

Now select tracks 1 and 2 (RECORD tab) simultaneously to ensure complete memory erase. The LEDs start blinking and the metronome, if activated, stresses the musical quarters. In case you have selected the metronome function, you may adjust the record speed using the tabs (SEQUENCER section), otherwise the record rate will be adjusted automatically. At this point you can enable the record phase pressing either the START/STOP switch or the left optional pedal (SEQUENCER START/STOP position - see par. 14). The LED of the SEQUENCER

or the left pedal (SEQUENCER START/STOP pos.); the recorded sequence will be automatically played back. PLAY is automatically selected for track 1. Now you may record also on the second track available. Stop the PLAY function with the START/STOP tab then select RECORD on track 2. Selecting PLAY for track 1 makes it possible to play-back at the same time the first track you had recorded. Remember that as soon as you start recording (after pressing the START/STOP switch or the left pedal when in SEQUENCER START/STOP pos.), DK-80 memorizes all events, including pauses.

To record one or more notes on the first bar beat, simply keep them pressed before entering the record phase (i.e. before pressing the START/STOP switch/pedal). Keep in mind that the sequencer memory can be used totally either for track 1 or for track 2, thus limiting the next over-recording. This is why we recommend that every time you start a new sequence you select both tracks.

Once the record phase is over, DK-80 automatically selects the PLAY function (play back) and keeps playing back the recorded musical phrases (LOOP). In case you have used the whole memory space the instrument exits the record phase and the LEDs go off automatically, but the playback function is not automatically enabled.

Pressing PLAY the recorded pieces will be played back, but they will not be looped.

19. M.I.D.I. (Musical Instrument Digital Interface)

The DK-80 features a universal interface system used in several applications. The instrument actually communicates with - and is prepared to receive data from - other M.I.D.I. equipped devices. It is possible to make different instruments all play from one keyboard, or to connect your synth to a personal computer, to a poly sequencer, etc. With the MODE switch you can select the INTERNAL, EXTERNAL, INTERNAL/EXTERNAL functions in order to communicate and or receive possible program changes. If you want to play two synths through M.I.D.I., connect the MIDI input (IN) of one synth to the MIDI output (OUT) of the other one, and vice-versa.

Now the two instruments are interconnected, ready to communicate with each other and transmit the notes you will play on one of the two keyboards. If you set the DK-80 MODE switch to EXTERNAL it will be possible for you to change the other synth's program and receive program changes through the commands of the other instrument; setting it to INT/EXT you can change both instrument's programs simultaneously.



20. M.I.D.I. CONNECTIONS

The following diagrams show the most common basic connections:

MIDI SYNTH + EXPANDER

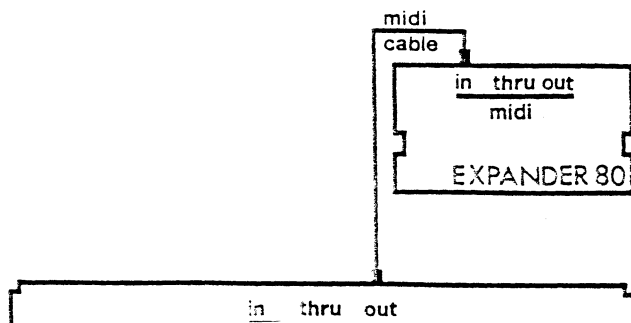

MIDI SYNTH. + 2 × EXPANDERS

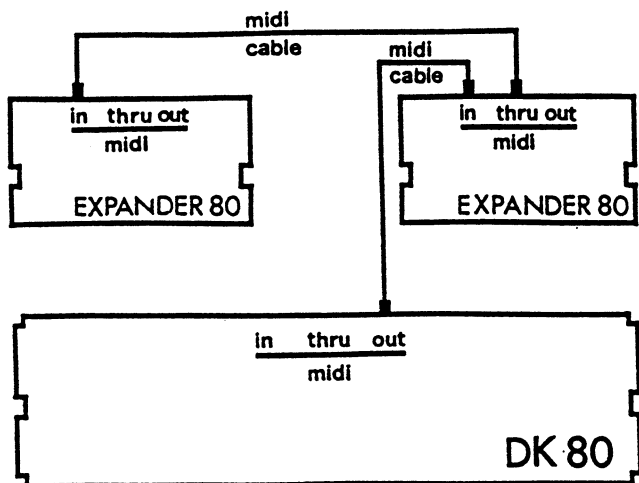

23. ACCESSORIES

The following accessories will be supplied on request:

- RAM PACK: programmable additional memories. With this type of «CARTRIDGE» it is possible to memorize 50 additional timbric presets and use them directly on line.
- ROM PACK: non programmable additional memories. With this type of «CARTRIDGE» it is possible to have 100 additional presets, already memorized by the factory, directly on line.

- Programmable multifunction pedal (5)
- Folding support stand (4)
- Hard case
- Expander 80 with fixing support (3)
- Midi Computer Interface
- Midi Connection cables
- Jack/Jack Cables
- DK 80 graphic sound editor software
- Midi Software

The instrument is complete with an AC/AC power supply (1).

21. CONNECTION TO COMPUTERS

It is possible to connect the DK-80 to computers based on CPU Z80, 6502, 6510 (SINCLAIR ZX SPECTRUM, SINCLAIR ZX 81, VIC 20, CBM 64, APPLE II...) through SIEL MIDI COMPUTER INTERFACE (optional).

This makes it possible, using specific software, to obtain several musical applications by means of the Computer.

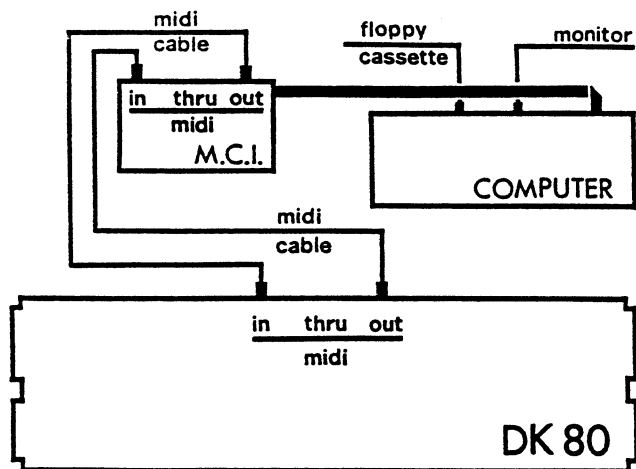

22. FACTORY PROGRAMS

The SIEL DK-80 contains many different types of sounds in its original set of factory patches. While these by no means represent the total of the DK-80's capabilities, they can be used as an excellent starting point. Each factory sound has a name which bears some descriptive relationship to the sound itself, wherever possible.

The programs are listed on a separate sheet.

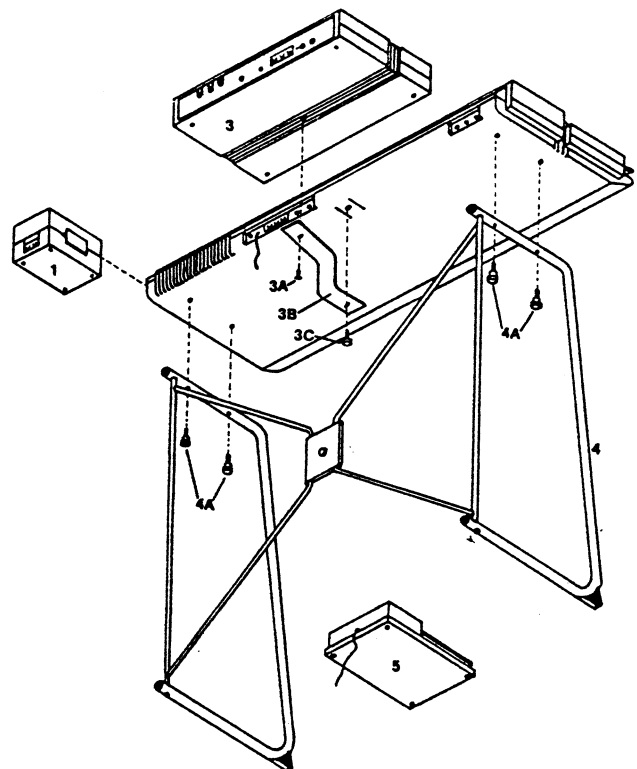

Patch

41 start

71. 0-0
 72. 15-8
 75-10-13
 32.-11-8
 33-0-15
 34-00-00
 35-00-20
 36-4-4

61-

62 2 saw ←
 1 pulse

63-16
 67-1-5

CC For Unit

Por-CC

11-21	51-45
12-22	52-46
13-23	53-47
14-24	54-48
15-25	55-49
16-26	61-50
17-27	62-51
18-28	63-52
	64-53
	65-54
21-29	66-55
22-30	67-56
23-31	71-57
	72-58
31-32	73-59
32-33	74-60
33-34	75-61
34-35	81-62
35-36	
36-37	82-63
37-38	
	91
	92
41-39	93
42-40	94
43-41	
44-42	
45-43	
46-44	

(68) A or B Select

Hold-66
 Clifford 67