

# YAMAHA



**DIGITAL SEQUENCE RECORDER**

**OWNER'S MANUAL**

---

---

# ABOUT THIS MANUAL

---

---

Thank you for purchasing the QX5 Digital Sequence Recorder. The QX5 is an 8 track MIDI sequencer with extensive editing functions and superb flexibility, yet easy to learn and simple to use. In order to understand the QX5 and take full advantage of its capabilities, please read through this manual and try out the examples.

---

---

## CONTENTS

---

---

<b>ABOUT THIS MANUAL</b> .....	1	<b>LOAD/SAVE (TAPE/MIDI/SET UP)</b> .....	34
<b>HOW DOES THE QX5 WORK?</b> .....	2	<b>SETUP</b> .....	38
<b>FEATURES</b> .....	4	<b>MIDI 1</b> .....	41
<b>PRECAUTIONS</b> .....	5	<b>MIDI 2</b> .....	44
<b>OPERATION GUIDE</b> .....	6	<b>OTHER FUNCTIONS</b> .....	46
<b>FRONT/REAR PANEL</b> .....	7	<b>TAPE SYNC</b> .....	47
<b>SIMPLE RECORDING EXAMPLE</b> .....	9	<b>IDEAS AND SUGGESTIONS</b> .....	48
<b>MAIN FUNCTIONS</b> .....	12	<b>MESSAGES</b> .....	49
<b>DISPLAY</b> .....	12	<b>SYSTEM EXCLUSIVE DATA FORMAT</b> .....	50
<b>TEMPO</b> .....	12	<b>SPECIFICATIONS</b> .....	51
<b>MEASURE</b> .....	13	<b>MIDI IMPLEMENTATION CHART</b> .....	52
<b>TRACK</b> .....	13	<b>WHAT'S HEXADECIMAL?</b> .....	53
<b>CLOCK</b> .....	14	<b>WHAT'S MIDI?</b> .....	55
<b>RECORDING</b> .....	15		
<b>REALTIME RECORDING</b> .....	15		
<b>PUNCH IN RECORDING</b> .....	16		
<b>STEP RECORDING</b> .....	17		
<b>EVENT EDIT</b> .....	20		
<b>MEASURE EDIT</b> .....	25		
<b>TRACK EDIT</b> .....	30		

---

---

## HOW DOES THE QX5 WORK?

---

---

This section will give you a quick overview of the QX5. When you play a MIDI keyboard, it sends messages indicating which note was played and how strongly, sustain pedal on/off, etc. The QX5 digitally records these messages and can "play" them back, causing a MIDI tone generator to produce sound. To use the QX5, you need a MIDI keyboard and at least one MIDI tone generator or synthesizer.

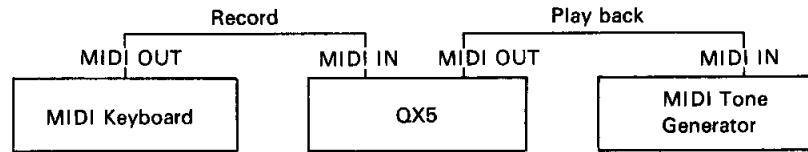

For example you can use a Yamaha DX7 as MIDI keyboard, a Yamaha TX816 as tone generator and add a Yamaha RX11 for drum tracks.

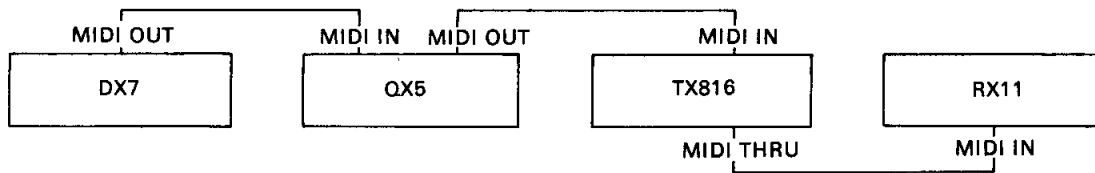

---

### RECORDING

#### *Realtime*

Notes are recorded in the timing that you play them.

#### *Punch In*

The same as realtime recording, but you can set the point at which recording will begin and end.

#### *Step*

You can use a MIDI keyboard to enter notes and specify their timing and gate time using the QX5 panel switches.

---

### EIGHT TRACKS

8 tracks of MIDI data can be stored, edited, saved and loaded independently. Recording is always done on track 1. When you have finished recording a track, you can exchange track 1 with an empty track (2-8) and record again. Channel information is recorded, and each track can contain independent MIDI data of up to 16 channels. Tracks can be joined, mixed, cut, deleted, exchanged, etc. Each track can be turned on or off for playback.

---

## THIRTY-TWO MACROS

Think of a macro as a "floating track." A macro contains the same data as a track, and tracks and macros can be freely exchanged. A macro number can be inserted at any point in a track. When playback comes to that point in the track, the data in the macro will begin playing along with the data in the tracks. Up to 4 macros can be playing at once.

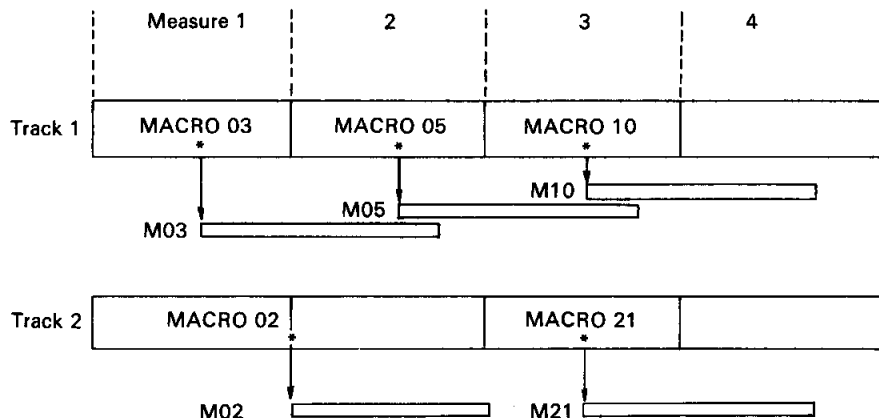

Macros are handy for repeated phrases, or as temporary storage. There is no limit to the capacity of a track or macro, but the total number of recorded notes (tracks + macros) must be less than 20,000. (If Note On Velocity data is recorded, capacity is about 15,000 notes.)

---

## EDITING

### *Event Edit*

Edit individual MIDI "events". You can go in and change, insert, delete, or change the timing of individual notes or data such as Program Change messages.

### *Measure Edit*

Edit individual measures. You can delete, insert and copy measures, and selectively remove or change certain data from specified measures.

### *Track Edit*

Edit whole tracks. You can exchange, copy, mix, erase, and connect tracks, and transfer specified data to another track or macro.

---

---

# FEATURES

---

---

The QX5 offers an unprecedented array of features in a compact unit, just the right size for placing on top of a keyboard, and is the same width as the TX7 Tone Generator and RX21 Rhythm Programmer for easy stacking.

- Tracks & Macros** 8 tracks (p. 2) and 32 macros (p. 3) give you great versatility in your composing and arranging.
- Memory Capacity** You can record approximately 20,000 notes (15,000 when recording velocity data). Recording controller data (Aftertouch, etc.) will also use memory.
- Relative Tempo** Tempo changes can be inserted at any point.
- 3 Position Memories** Three measure positions can be stored and jumped to at the touch of a switch.
- Auto Locate** Recording can be set to automatically begin from a certain measure.
- Punch In/Out Recording** You can set recording to begin and end at specified measures.
- Step Recording** A MIDI keyboard and the QX5 panel switches can be used to enter complex phrases note by note.
- Unlimited Editing** Recorded data can be edited by track, measure or event (p. 3).
- 4 Setup Memories** MIDI reception and transmission conditions and QX5 settings can be set and stored in 4 memories for instant recall.
- MIDI re-channelizing** Each incoming and outgoing channel of MIDI messages can be independently re-assigned to a different channel.
- Tape Sync** An FSK tape sync signal can be recorded on tape to synchronize the QX5 with a multitrack recording.
- Backlit LCD** The two-line 16-character LCD is backlit for easy visibility even in dim lighting.
- Tape or MIDI Save/-Load** Sequence data can be saved to and loaded from a data cassette tape or a MIDI data managing device.
- STOP!** If you are a little unsure about your understanding of MIDI, go and read p. 53 "What's Hexadecimal" and p. 55 "What's MIDI?"

---

---

# **PRECAUTIONS**

---

---

## **LOCATION**

Avoid placing the QX5 in direct sunlight or close to a source of heat. Also, avoid locations in which the device is likely to be subjected to vibration, excessive dust, cold or moisture.

## **HANDLING**

Avoid applying excessive force to the switches, dropping or rough handling. While the circuitry is of reliable integrated circuit design, the QX5 should be treated with care.

## **POWER CABLE**

Always grip the plug directly when removing it from an AC receptacle. Removing the plug from the AC receptacle by pulling the cable can result in damage to the cable, and possibly a short circuit. It is also a good idea to disconnect the QX5 from the AC receptacle if you don't plan to use it for an extended period of time.

## **CLEANING**

Use only a mild detergent on a cloth, and dry with a soft cloth. Never use solvents (such as benzene or thinner) since they can melt or discolor the finish.

## **ELECTRICAL STORMS (LIGHTNING)**

Computer circuitry, including that in the QX5, is sensitive to voltage spikes. For this reason, the QX5 should be turned off and unplugged from the AC receptacle in the event of an electrical storm. This precaution will avoid the chance that a high voltage spike caused by lightning will damage the device.

## **ELECTROMAGNETIC FIELDS**

Computer circuitry is also sensitive to electromagnetic radiation. Television sets, radio receivers, transmitters and transceivers, and wireless microphone or intercom systems are all potential sources of such radiation. The QX5 should not be placed too close to such devices.

# OPERATION GUIDE

The QX5 Top Panel contains a JOB TABLE to show how to enter job groups and quick guides of EVENT EDIT and STEP RECORD. It is for your reference when you operate the QX5.

---

### STEP RECORD

FREE MEMORY

STEP	250
1/04	080% 064
STEP TIME	GATE TIME VELOCITY

↑↓ DISPLAY

M=0001-01-00/96
1/04 080% 064

STEP TIME	CLOCK	STEP TIME	CLOCK
1/02	192	1/16	24
1/03	128	1/24	16
1/04	96	1/32	12
1/06	64	1/48	8
1/08	48	1/64	6
1/12	32	1/96	4

### EVENT EDIT

MEASURE	BEAT	CLOCK
M=0001-01-00/96		
NOTE (1)	C . . 3	064
EVENT		DATA

NOTE	PROGRAM
AFTER TOUCH	EXCLUSIVE
PITCH BEND	MACRO
CONTROL	TEMPO
MODE	MEASURE

SEARCH ← F1 → CHANGE
F3 BACK      F2 CURSOR
F4 FWD        F3 -1
F4 +1
SHIFT + RECORD    DELETE
SHIFT + STOP      INSERT
SHIFT + START     REPLACE

### JOB TABLE

TEMPO	MEASURE	TRACK	CLOCK
▼	▼	▼	▼

Press with SHIFT ▶

EVENT EDIT	MEAS EDIT	TRACK EDIT	LOAD/SAVE
SEARCH CHANGE	COPY DELETE REMOVE SHIFT QUANTIZE TRANPOSE VELOCITY GATE TIME CRESCENDO CREATE	EXCHANGE COPY TR.DOWN CLEAR CUT INSERT EXTRACT CLOCK MOV THIN OUT SHIFT	TAPE SAVE TAPE LOAD TAPE VERIFY MIDI TRANSMIT MIDI RECEIVE SETUP STORE SETUP RECALL

Press Twice ▶

SETUP	MONITOR	MIDI 1	MIDI 2
BEAT/MEASURE CLICK REPEAT MEM.PROTECT FOOT SWITCH LOCATE DELAY	INPUT MONITOR OUTPUT MONITOR	INPUT ASSIGN OUTPUT ASSIGN VELOCITY AFTER TOUCH PITCH BEND CONTROL CHNG SYS.EXCLUSIVE	REMOTE IN REMOTE OUT ECHO DEVICE NUMBER

## JOB TABLE

The four main function switches (Tempo, Measure, Track and Clock) each access two job groups, one group when double-clicked, and one group when pressed while holding **[SHIFT]**. To exit from the Job mode, press one of these function switches or **[SHIFT] + [RESET]**.

## EVENT EDIT

This guide contains an illustration of the LCD, a list of events and a diagram of EDIT operations. For details see EVENT EDIT (p. 20).

### Search

When the cursor is hidden, use **[F3]** (◀), **[F4]** (▶) to move through track 1 searching for events you want to change. Press **[F1]** (JOB) to switch from Search to Change. The cursor will start blinking.

### Change

Use **[F2]** (CURSOR) to select what you will change (Position, Event, Data), and use **[F3]** (◀), **[F4]** (▶) to change the value.

Then, you need to Delete, Insert or Replace the event using **[SHIFT]** and **[RECORD]**/**[STOP]**/**[START]**.

## STEP RECORD

This guide contains illustrations of the LCD and a table showing the number of clocks per step. For details see STEP RECORDING (p. 17).

### Step Time

Time value of the note (1/2 - 1/96).

### Gate Time

Length the note is held, displayed as a percentage of the Step Time.

### Velocity

Force with which the note is played (1 - 127).

### Free Memory

Unused memory in blocks of 80 notes.

By pressing **[DISPLAY]**, you can display the current position; measure, beat, clock.

# FRONT/REAR PANEL

## FRONT PANEL

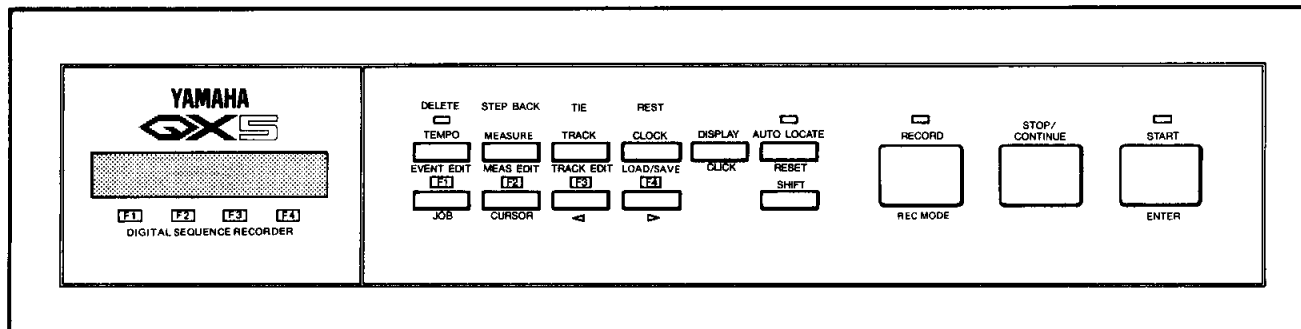

### LCD

A two-row 16-character Liquid Crystal Display, backlit for high visibility.

★ The Job Guide on p. 6 describes the functions of the following 4 switches when pressed with **[SHIFT]** and when double-clicked.

### TEMPO

Display and change the current tempo. The LED blinks to indicate the current tempo. While **[SHIFT]** is pressed, you can recall and set the Tempo Memories.

### MEASURE

Move through the measures of a song (fast forward and rewind). While **[SHIFT]** is pressed, you can recall and set the Measure Memories.

### TRACK

Each track can be switched on or off. **[F1]** - **[F4]** switch tracks 1-4. While **[SHIFT]** is pressed, **[F1]** - **[F4]** switch tracks 5-8.

### CLOCK

The QX5 can be controlled by its own internal clock, MIDI clock, or tape (FSK) clock. While **[SHIFT]** is pressed, the Clock Output can be turned on or off.

### DISPLAY (CLICK)

Select display mode. Tempo, Measure, Track and Clock can each have their own display (with help message) or all be shown in one display (no help messages). When pressed with **[SHIFT]**, the click is turned on or off.

**AUTO LOCATE (RESET)** When this is on, pressing **[START]** will begin recording or playback from the measure in the first (left) Measure Memory. The LED indicates Autolocator On. You can loop between the current measure and the first Measure Memory by pressing **[SHIFT]** + **[START]**. By pressing **[SHIFT]** with this switch, you can abort the current operation.

**RECORD (REC MODE)** Enter record mode. When **[RECORD]** is pressed with **[SHIFT]**, the Record Mode will change.

**STOP/CONTINUE** Stop recording or play. If pressed again, play will continue from that point. If pressed after **[RECORD]**, recording will begin from that point.



**START (ENTER)**

Start recording or play from the beginning of the song. When editing, executes the selected function.

★ Switches **F1** – **F4** perform the function indicated in the LCD above the corresponding numbers **F1** – **F4**.

**F1 (JOB)**

When performing a Setup, Edit or Load/Save function, **F1** steps through the jobs.

**F2 (CURSOR)**

When performing a Setup, Edit or Load/Save function, **F2** moves the cursor.

**F3 (◀)**

When performing a Setup, Edit or Load/Save function, **F3** decrements the data indicated by the cursor.

**F4 (▶)**

When performing a Setup, Edit or Load/Save function, **F4** increments the data indicated by the cursor.

**SHIFT**

Used to access the functions printed in purple below the keys. Holding down **SHIFT** reverses the movement of the **JOB** and **CURSOR** keys.

---

---

**REAR PANEL**

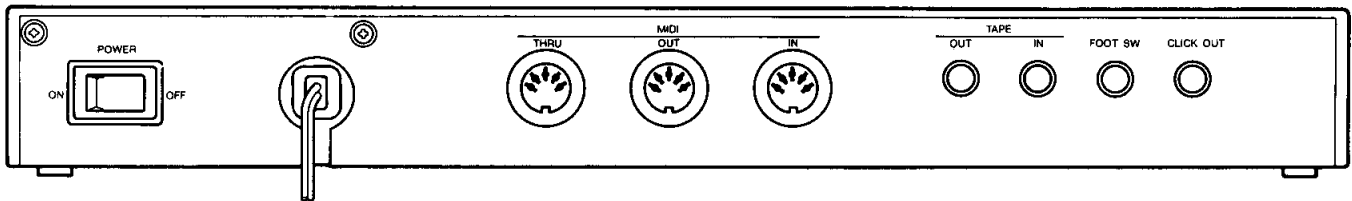

**MIDI THRU**

All messages received at MIDI IN are sent unchanged from this terminal.

**MIDI OUT**

Sequence playback and other MIDI messages are sent from here. You may set the MIDI OUT to echo back messages received at MIDI IN.

**MIDI IN**

MIDI messages coming in to this terminal can be recorded by the QX5.

**TAPE OUT**

In play and record mode, this sends an FSK tape sync signal. In load/save mode, it sends sequence data to tape.

**TAPE IN**

In play and record mode, this receives an FSK tape sync signal. In load/save mode, it receives sequence data from tape.

**FOOT SW**

An optional footswitch such as the FC4 or FC5 can be used to start, stop or continue playback or recording.

**CLICK OUT**

The metronome signal is output from this jack to an external mixer or amp. The internal click tone will go off if this is connected.

---

---

# SIMPLE RECORDING EXAMPLE

---

---

To give you a general idea of how to use the QX5, we will show you how to record in real time.

---

## CONNECTIONS

---

Connect the QX5 to your keyboard and tone generator as shown on p. 2. If you are using the QX5 with a single MIDI synthesizer, connect the synthesizer MIDI OUT to QX5 MIDI IN, and QX5 MIDI OUT to the synthesizer MIDI IN.

---

## SETTINGS

---

Recording on the QX5 is usually very simple; just press **RECORD** and then **START**. But in order to make this example absolutely foolproof, we will make sure all settings are correct. We will give detailed explanations of each function later.

### Memory Protect

For us to record, memory protect must be off. Double-click the **TEMPO** switch (quickly press it twice). Press **JOB** three times to get the Memory Protect display, and press **◀** to make it read "MEM.PROTECT OFF."

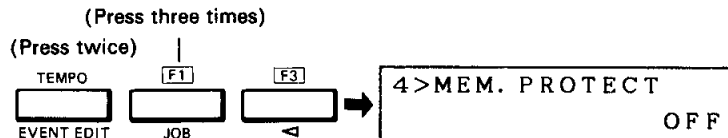

### Echo

We need to hear ourselves play, so we will set the QX5 to transmit all messages received at MIDI IN directly from MIDI OUT. (This is called Echo Back.) Double-click the **CLOCK** switch. Press **JOB** twice to get the Echo display, and press **◀** or **▶** to make it read "DIRECT".

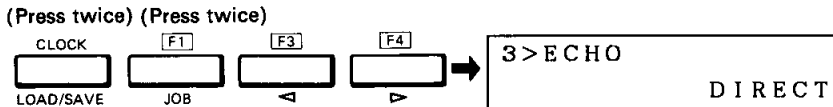

### Channel Assign

We want to record MIDI messages coming in on channel 1, and play them back on the same channel. Check to make sure that your keyboard is transmitting on channel 1 and that your tone generator is receiving channel 1 (see the owner's manual for each device).

Double-click the **TRACK** switch. The display will show "INPUT ASSIGN", with a blinking cursor at the lower far left. The number at the cursor should be "1". If not, use **◀** or **▶** to change it to "1".

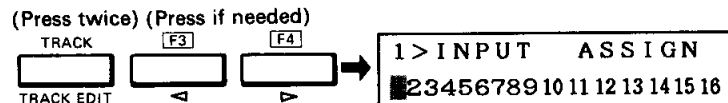

Press **[JOB]** and the display will show "OUTPUT ASSIGN." In the same way you did with Input Assign, make sure the far left number is "1".

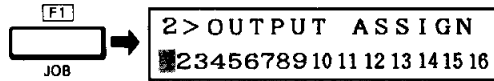

**Clock**

We will set the QX5 clock to **[INTERNAL]**. Press **[CLOCK]** and then **[F4]**. The display will show "CLOCK IN=INT" or "C=INT."

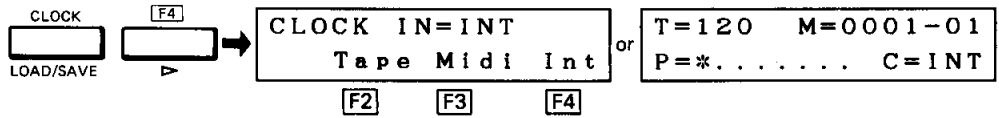

**Track 1 On**

For us to record on track 1, it must be turned on. Press **[TRACK]** and then **[F1]** to make "1" or "\*" appear. (Each time you press **[F1]**, "1" or "\*" will alternate with ".")

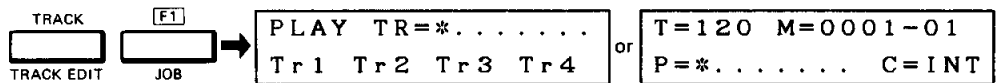

**Realtime Record**

While holding down **[SHIFT]**, press **[REC MODE]**. Each time you press **[REC MODE]**, the display will move between "REALTIME", "PUNCH IN", and "STEP." Make it read "REALTIME."



**Metronome**

While holding down **[SHIFT]**, press **[CLICK]** to turn the metronome on or off. (If it's too fast, or sounding in a strange time signature, just leave it off. We will explain how to set this later.)

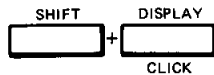

**START RECORDING**

When you selected the recording mode, the Record LED came on. Pressing **[START]** will begin recording. After a two-measure countdown, anything you play will be recorded. Play 20 or 30 measures so that we have something to work with.

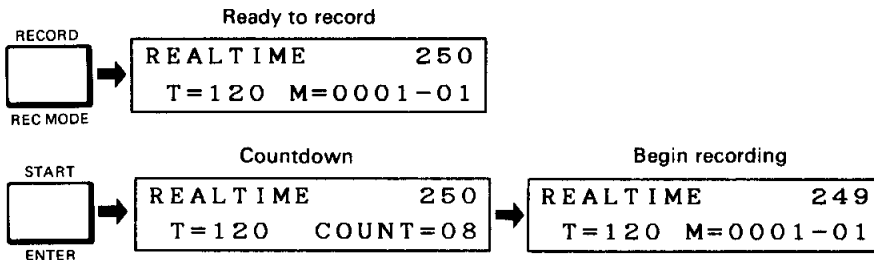

When you have played enough, press **[STOP/CONTINUE]**. Both LEDs will go off.

---

---

## **PLAYBACK**

Pressing **START** will playback what you have just recorded. Press **MEASURE** and use **<▶** to "rewind" or "fast-forward."

### ***Start/Stop/Continue***

The **STOP/CONTINUE** key is dual-function. Pressing **STOP/CONTINUE** during playback or recording will stop. Press it again to continue playback or recording from that point. For example, you can stop playback (press **STOP**), use **<▶** to find the measure you want, and continue from that point.

When stopped, pressing **START** will playback or record from the beginning.

Working through the above should give you an idea of what MIDI recording is like. To fully understand the possibilities and freedom the QX5 gives you, go on and read the rest of this manual, taking time to try out each function.

# MAIN FUNCTIONS

The four main functions (Tempo, Measure, Track and Clock) can be accessed by pressing one of the four switches and using [F1] - [F4] to change the setting. You have a choice of displays for these 4 functions.

## DISPLAY

You may choose to display all four function settings together, or separately. To switch display modes, press [DISPLAY]. When displayed separately, the lower line of the LCD will remind you what [F1] - [F4] do (ie. a "help" message) for each function. Whichever display is selected, [TEMPO], [MEASURE], [TRACK] and [CLOCK] will select the function, and [F1] - [F4] will change the settings. In the "together" display, the blinking cursor indicates which function is selected. Once you are familiar with the QX5, the "together" display may be more convenient, but in this manual the illustrations will always be the "separate" display.

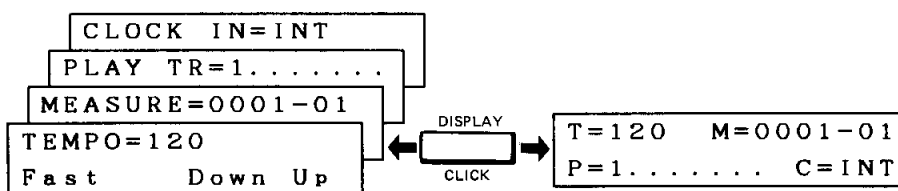

## TEMPO

Press [TEMPO] and use [F3] and [F4] to change the tempo between 40 and 300, indicating the number of quarter notes per minute. While you hold down [F1], the tempo will be multiplied by 4. This is useful when you want to quickly find a certain section while playing back. [F2] has no effect in Tempo mode.

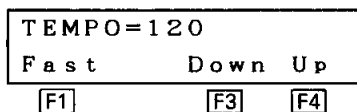

### Tempo Memory

You can preset 3 different tempo for instant recall. Press [SHIFT] and the display will show the three preset tempo. Pressing [F2] - [F4] while holding [SHIFT] will set the tempo to the selected value. To change a tempo preset, continue holding [SHIFT] and press [F1]. The cursor will start blinking on the "S" of "Save." Now press [F2] - [F4] to save the current tempo in a preset.

#### Recall Tempo Memory

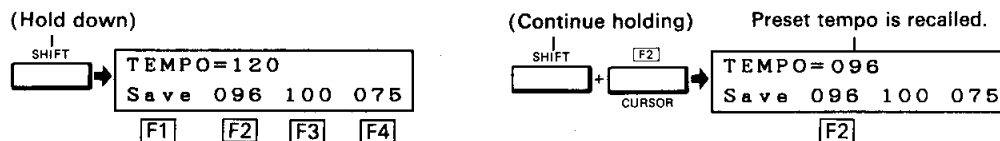

#### Save Tempo Memory

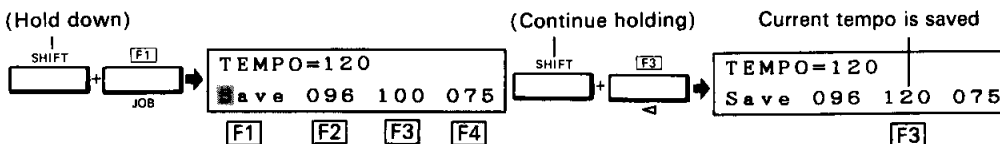



### Track On/Off

While stopped, you can switch tracks 1-8 On or Off. (This will automatically return you to measure 1.) When a track that contains data is turned on, its number will be displayed. When a track that has no data (or has come to the end of it) is switched on, a "\*" is displayed. As you near the end of a multi-track composition, the track numbers will change to "\*" as they run out of data. In the example below, tracks 1-5 are on, but tracks 3 and 5 have no more data.

```
PLAY TR=12*4*...
Tr1 Tr2 Tr3 Tr4
```

### Track Mute

During playback, you can switch tracks between On and Mute (indicated by "-"). A Muted track will not send data. When **STOP** is pressed or the data in the track ends, Muted tracks are reset to On. In the example below (during playback), tracks 1,2,3 and 8 still have data, but only 3 and 8 are playing.

```
PLAY TR=-_3*... 8
Tr1 Tr2 Tr3 Tr4
```

---

## CLOCK

Press **CLOCK** and use **F2** - **F4** to select the master timing clock for the QX5.

```
CLOCK IN=INT
      T a p e M i d i I n t
      [F2] [F3] [F4]
```

### Internal Clock

The QX5 internal clock determines the tempo. When **INT** is selected, you can change the tempo from the QX5 panel keys (p. 7).

### MIDI Clock

A MIDI clock-producing device (rhythm programmer, sequencer, etc.) connected to the QX5 MIDI IN will determine the tempo.

### Tape Clock

An FSK tape sync signal received at the Tape In jack will determine the tempo. (See Tape Sync, p. 47.)

### Clock Out

You can choose whether or not to transmit clock (timing) data from MIDI OUT and Tape Out. Hold down **SHIFT** and use **F3** and **F4** to turn Clock Out off and on.

```
SHIFT [ ]+
      CLOCK OUT=OFF
      O f f O n
      [F3] [F4]
```

If you switch this during playback, the display will change immediately, but the clock signals will begin on the next beat. Tape Out will not send clock data while the QX5 is stopped.

# RECORDING

All recording is done on track 1. In order to record, track 1 must be on (p. 13) and Memory Protect must be off (p. 39). When you press **[RECORD]**, the Record LED will light, the display will show the currently selected Record Mode (Realtime, Punch In, Step), and the measure counter will move to the beginning of the current measure. When the Record LED is lit, you will not be able to enter other modes. Press **[RECORD]** again to exit record mode.

## Recording Mode

You can change the Record Mode by pressing **[REC MODE]** while holding **[SHIFT]**. (When power is first turned on, Realtime Record is selected.)

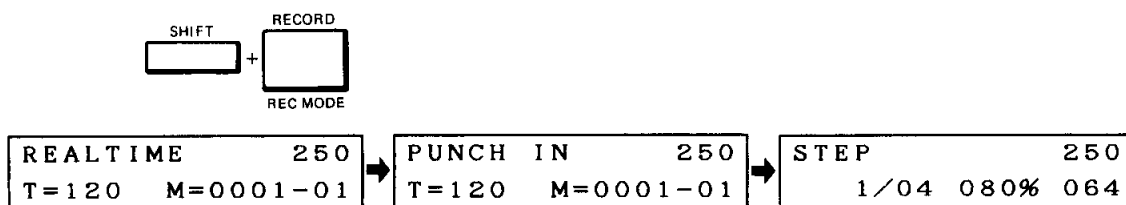

## REALTIME RECORDING

Realtime recording is where the QX5 records your performance just as you play it. The number in the upper right indicates the size of free memory in blocks of about 80 notes (without velocity). In Record mode, holding down **[F1]** will speed the tempo up x4, and **[F3]** **[F4]** will decrease and increase tempo just as in Tempo mode. Tempo memories (p. 12) can be recalled, but not saved.

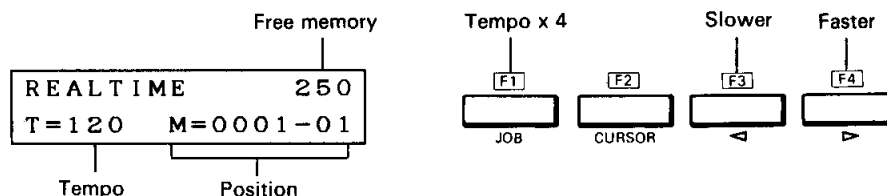

## Countdown

To record from the beginning, press **[START]**. To record from the current measure, press **[CONTINUE]**. If Clock=Internal, you will get a 2-measure countdown (metronome and display) before recording begins. You can send a Program Change message during the countdown, and it will automatically be recorded at the top of the measure you begin recording on. If Clock=MIDI or Tape, there is no countdown. Also, if you have set Click to Manual (see p. 38) and turned it off, there will be no countdown.

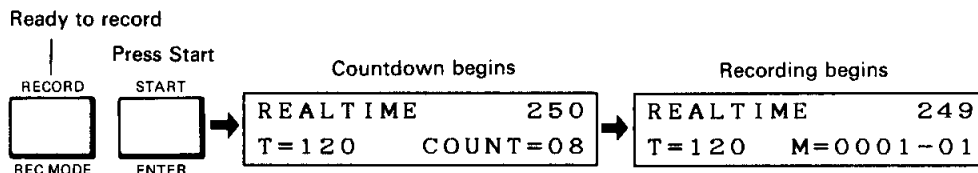



## Measure Marks

Whether or not the metronome automatically comes on during recording will depend on the Click setting (p. 38), but you can always turn it on/off by pressing **CLICK** while holding **SHIFT**. The metronome is accented on the first beat of each measure. If tracks 2-8 are playing, the measure marks (p. 24) in those tracks will determine how the measure marks are recorded. If no other tracks are playing, the Beat/Measure setting (p. 38) will determine the measures. (You can take advantage of this to produce some interesting polyrhythms!) If track 1 is shorter than other tracks and the current measure is past the end of track 1 when you continue recording, empty measures will be filled in appropriately.

To stop recording, press **STOP**. The Record and Start LEDs will go off, and the display will show "Executing", then return to the previous mode.

## Auto Locate

In Realtime Record, you can use the Auto Locate function to start recording from a specified measure. If you press **START** when Auto Locate is off, you will begin recording (or playback) from measure 1. But if you press **START** when the Auto Locate is on, recording (or playback) will begin from the measure memory **F2** (see p. 13). If you press **START** during recording, you will begin recording from the measure memory, and data already recorded will be lost.

A Start message received via MIDI will make the QX5 start play or record from measure 1, regardless of Auto Locate. See also Loop Playback, (p. 46).

---

## PUNCH IN RECORDING

Punch In recording is much like Realtime recording. However, even though both the Record and Start LEDs will be on, actual recording will be done only between specified measures.

Set the Punch In/Out points using the Measure Memory function (p.13). **F3** is the Punch In point, **F4** is the Punch Out point.

### Enter Punch In Record mode

Press **DISPLAY** to show either the current position or the beginning (punch in) and end (punch out) of recording.

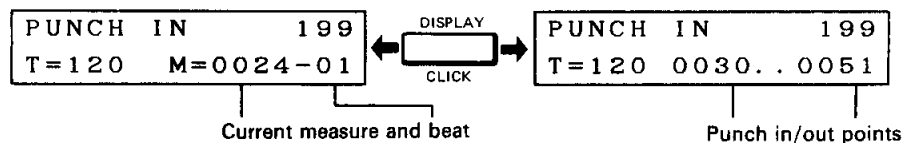

When you press **CONTINUE** or **START**, the QX5 will playback normally until it reaches the Punch In point, when recording will begin. When it reaches the Punch Out point, playback will resume. There is no countdown for Punch In recording.

### Punch In/Out Points

Suppose you wanted to rerecord a few measures in the middle of a song. Set the Punch In/Out points, move to a spot a few measures before the section, and Continue recording. Play along with the already recorded performance. When you reach the Punch In point, the recorded part will drop out, and your new performance will be recorded. When you come to the Punch Out point, the old performance will reappear.

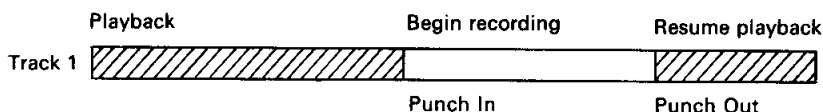

When you press **[STOP]**, the measure counter will return to the point where you started or continued playback before punch in. This is very handy when making repeated tries over the same section. You can set a footswitch (p. 39) to CONTINUE/STOP, and if you make a mistake, press the footswitch and have another try!

**NOTE**

In Punch In Record, you can use the Auto Locate function to start playback from a specified measure. See p. 16.

---

## STEP RECORDING

This is where you use the QX5 keys and a MIDI keyboard to enter data step by step, making it possible to create phrases that would be difficult to play in real time. Measure marks are created according to the Beat/Measure setting, and are not affected by measure marks of other tracks.

To speed up data entry, Gate Time, Velocity, Ties, and Rests can be entered using MIDI controllers such as Modulation Wheel, Data Entry Slider etc. (Quick Input Via MIDI, p. 19.)

### Step Recording Display

By pressing **[DISPLAY]**, you can choose between displaying the amount of free memory, or displaying your current position (measure, beat, clock). You will probably want to display the position most of the time.

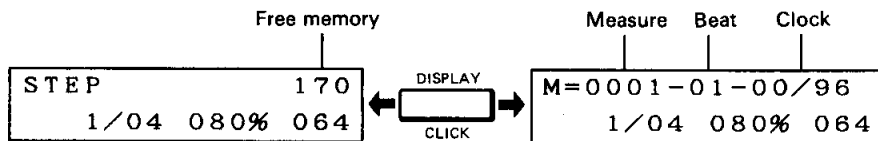

### Clock

For the QX5, the smallest subdivision of time is the "clock". One QX5 internal clock is 1/384th of a whole note. Thus, a whole note is 384 clocks, and a quarter note is 96 clocks. In the case of 4/4 time, each beat will have 96 clocks. You can see that the number of clocks per beat will differ according to the Beat/Measure setting (p. 38). For x/4 time, 96 clocks per beat; for x/8 time, 48 clocks per beat; and for x/16 time, 24 clocks per beat.

### Begin Recording

When you press **[START]** or **[CONTINUE]**, Step Recording will begin. Notes you play on the MIDI keyboard will be recorded at intervals of the step time. The actual timing with which you press the keys does not matter. For example if the Step Time is 1/16, each note will be a sixteenth note. To enter chords, press several notes together. To record single notes, each note must be released before the next is pressed. You can send Program Changes from the keyboard as usual, and they will be recorded along with the notes, but without a time interval.

---

## STEP RECORDING PARAMETERS

### Step Time

As usual, **[CURSOR]** moves the blinking cursor, and **◀▶** change the data at the cursor.

Step Time is the time value of the note. Each time you enter a note or chord, the position will advance by one of these steps, Step Time is variable from 1/2 to 1/96.

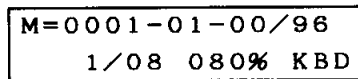

Step Time 1/2 - 1/96

## Gate Time

Gate Time is the percentage of the Step Time the note will sound. If gate time is 100%, a quarter note will last exactly 96 clocks. A gate time of 10% would be the same as playing staccato. Use **CURSOR** to move the blinking cursor to Gate Time, and use **◀▶** to set it between 10% and 300% in steps of 5%. (Also see Quick Input Via MIDI, p.19).

```
M=0001-01-00/96
  1/08 080% KBD
```

Gate time 10% - 300%

## Velocity

Velocity can be set to a fixed value (1-127) or set to KBD, when the velocity produced by the keyboard will be used. (Also see Quick Input p.19).

```
M=0001-01-00/96
  1/08 080% KBD
```

Velocity, KBD 1-127

---

## STEP RECORDING EXAMPLE

As an example, enter Step Recording mode and press **START**. Press **DISPLAY** to select the position display. Press **CURSOR** to move the blinking cursor to Step Time and use **◀▶** to make it read 1/8. Notes we enter now will be eighth notes. Press and release a note on the MIDI keyboard. Notice that our position is now M=0001-01- 48/96. Each beat is 96 clocks (assuming Beat/Measure is 4/4), and an eighth note is half a beat. Press and release another note. The position is now M=0001-02- 00/96, indicating the second beat of the first measure.

No notes yet

```
M=0001-01-00/96
  1/08 080% 064
```

After the first note

```
M=0001-01-48/96
  1/08 080% 064
```

After the second note

```
M=0001-02-00/96
  1/08 080% 064
```

---

## STEP RECORDING SWITCHES

### Tempo (Delete)

Erase the previous event (Note or Program Change). If more than one event had the same timing, all will be erased.

### Measure (Step Back)

Move back one step time interval without deleting anything.

### Track (Tie)

This is valid only immediately after inputting a note. It extends the timing of that note by one Step Time. (Also see Quick Input p. 19.)

### Clock (Rest)

This inputs a rest corresponding to the Step Time. (Also see Quick Input p. 19.)

### Auto Locate (Protect)

This will protect data that has already been Step Recorded. After pressing this, you will not be able to Delete data.

**Shift + Tempo**  
**(Delete Measure)**

Delete one measure.

**Shift + Track**  
**(Insert Measure Mark)**

Insert a Measure mark (p. 24) at the current position. This function can be used to input complex time signatures.

**Shift + Clock**  
**(Fill Rests)**

Fill the remaining part of the measure with rests.

---

## QUICK INPUT VIA MIDI

For quick input of Gate Time, Velocity, Tie and Rest, you can specify a MIDI controller to input the data from a DX or KX keyboard. Press **JOB** to get the display you want, and use **◀▶** to select the MIDI control number that you will use to input the data. When "Off" is selected, the data can be set only from the QX5.

For example, if you select control number 6 for Gate Time, moving a DX7 Data Entry Slider will adjust Gate Time. You might set Modulation Wheel (control number 1) to adjust Velocity, Data Entry -1/No (control number 97) to input a Tie, and Data Entry +1/Yes (control number 96) to input a Rest. You will see the QX5 Gate Time and Velocity display change as you move the controller.

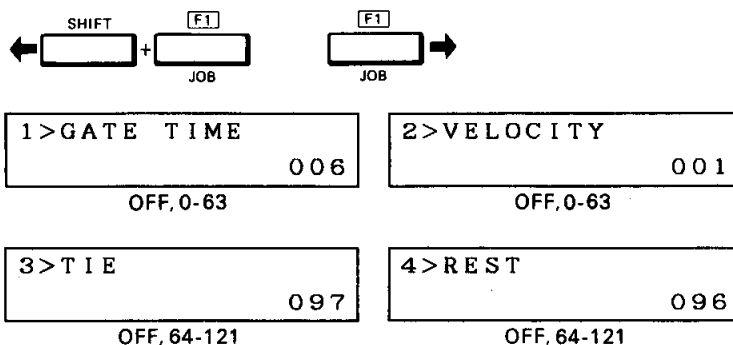

There is a table of MIDI control numbers on p. 22.

### NOTE

Gate Time can be adjusted via MIDI over a range of 10% to 95%. To set Gate Times of 100%-300%, use the QX5 front panel switches.

# EVENT EDIT

This is where you perform operations in track 1 on individual notes or other messages such as Sustain On/Off, etc. (These are called "events".) The upper line of the display will show the position of the event, and the lower line will show the event. To enter this mode, make sure that track 1 is on, and press **[SHIFT]** + **[EVENT EDIT]**.

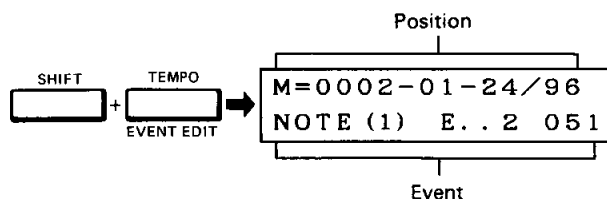

You can step through track 1 searching for events, and then change them or move them back and forward in time. Select between Search and Change by pressing **[JOB]**.

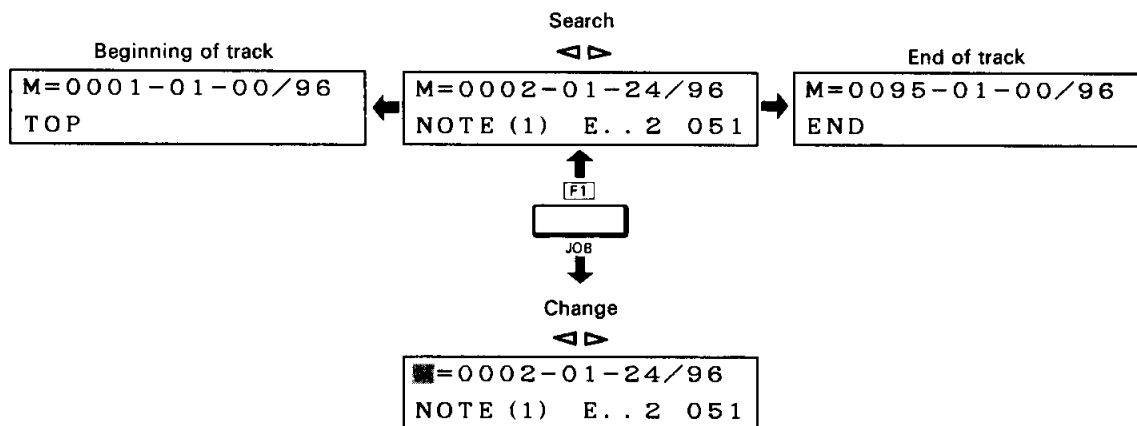

## 1. SEARCH

The cursor is hidden. Pressing **<>** will move to the next event. By pressing **[START]**, you can advance to the next event hearing each note. Pressing **[SHIFT]** + **<>** will jump one measure. The upper line of the display indicates the current position (Measure, Beat, Clock) as explained on p. 17. When you find the event, press **[JOB]**, and the cursor will start blinking.

## 2. CHANGE

The cursor is blinking. Press **[CURSOR]** to move the blinking cursor, selecting what you will change (**[SHIFT]** + **[CURSOR]** to move back), and **<>** to change it. (Each type of event will have different categories of data.) By pressing **[START]**, you can transmit the currently displayed note.

Move the event back and forth in time

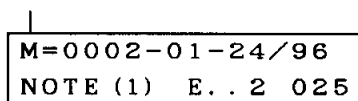

Change the event, channel and data

When you want to change the position (timing) of an event, put the cursor on "M" and use **<>** to move back and forth by individual clocks. **[SHIFT]** + **<>** moves the event by beat.

## Execute

Changes you make are not permanent until you Delete, Insert or Replace. To Delete the selected event, press **SHIFT** + **RECORD**. To Insert the modified event at the current timing, press **SHIFT** + **STOP**. To Replace the selected event with the modified event, press **SHIFT** + **START**. (None of these operations will affect the timing of other events.)

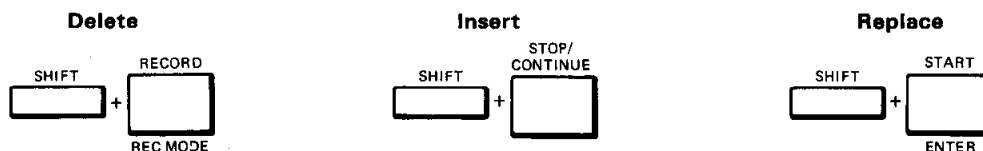

---

## EVENTS

You will encounter 10 types of events in Event Edit.

### Note

Note events are displayed as follows. Notice that the cursor has an "extra space to move" to change Gate time.

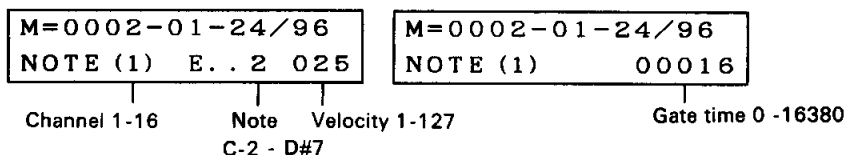

Gate time is the length of the note in "clocks" or 1/384 notes. It can be modified in steps of 4. Pressing **◀▶** while holding **SHIFT** will move in steps of 100.

### Aftertouch

Aftertouch (Common and Individual) events are displayed as follows.

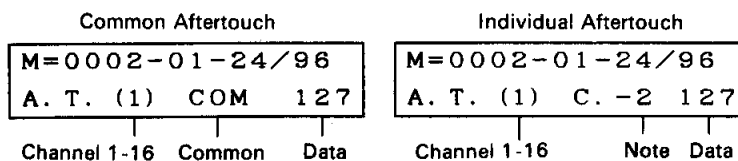

The Aftertouch on the DX7, KX88, etc. is Common Aftertouch, where a single Aftertouch valve is sent for the whole keyboard.

### Pitch Bend

Pitch Bend events are displayed as follows.

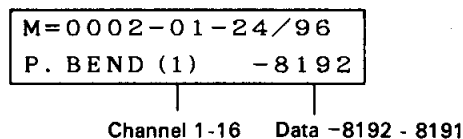

The above display indicates that the Pitch Bender has reached the lowest position. By pressing **◀▶** + **SHIFT**, you can change the Pitch Bend data in steps of 100.

### Control Change

Control Change events are displayed as follows.

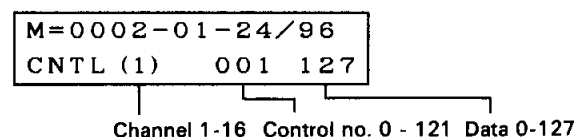

The example above would indicate that Modulation Wheel (Control #1) had reached its maximum position (127).

A list (in hexadecimal) of MIDI Control Changes is on p. 56, but here it is in decimal numbers.

Continuous Controllers (data is 0-127)	Switch Controllers (0 is Off, 127 is On)
1 Modulation Wheel	64 Sustain
2 Breath Controller	65 Portamento
4 Foot Controller	66 Sostenuto
5 Portamento Time	67 Soft
6 Data Entry Slider	96 Data Increment
7 Main Volume	97 Data Decrement

### Mode Change

Mode Change events are displayed as follows.

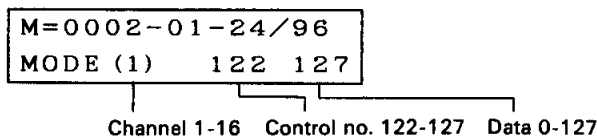

Mode Changes are a special group within Control Changes. Notice that most of them must have a certain data value. When editing, be careful not to set an unexpected data value.

#	Function	Data
122	Local	00: Off, 127: On
123	All Note Off	00
124	Omni Off	00
125	Omni On	00
126	Mono On	00-16
127	Poly On	00

#### NOTE

The QX5 will not record All Note Off, but when it is received, will check the Key Assign Table (p. 45 NOTE) and generate Note Off messages for whatever notes are currently on. Also, Mono On will be accepted only if the data is 1.

### Program Change

Program Change events are displayed as follows.

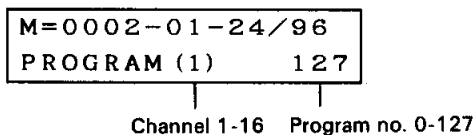

The response to a Program Change message will differ for each device. Yamaha products start with program #1, so when a DX7 receives Program Change #31, it will switch to Internal Voice 32. (DX7 Internal voices are 1-32, Cartridge voices are 33-64.) When a DX7 receives Program Change 64, it will "wrap around" and switch to Internal Voice 1. Consult the owner's manual for your device.

## Exclusive Dump

Exclusive is used to send a System Exclusive message from the QX5 during playback. Data is displayed simultaneously in Decimal and Hexadecimal form (see "What's Hexadecimal, p. 53).

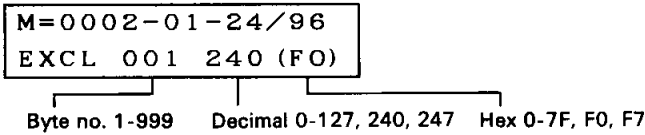

The first byte of the message will always be 240(F0), indicating the beginning of a System Exclusive, and the last byte will always be 247(F7), indicating the end of a System Exclusive. (These two bytes cannot be changed.) Step through the message by moving the cursor to Byte no. and using  $\leftarrow \rightarrow$ . If the Byte number is 1000 or above, 999 will be displayed. When the cursor is at the byte number, delete the data by pressing **[SHIFT]** + **[F3]**. Insert one byte of 0 by pressing **[F4]** + **[SHIFT]**.

For example if you wanted to send a Bulk Dump Request during playback, you could enter the appropriate MIDI bytes here. A Bulk Voice Dump Request on channel 1 for the TX7 would be

240(F0), 067(43), 032(20), 009(09), 247(F7)

See the System Exclusive Data Format for your device.

## Macro

A Macro is a sort of "floating track" (p. 3) that can be called at any point in a track. When called, the Macro will play along with the other tracks until it ends. You may have up to 4 Macros playing at once.

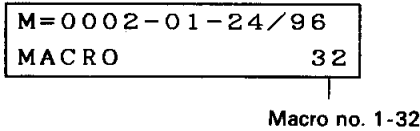

## Relative Tempo

When Clock=INT, Relative Tempo will change the actual tempo in relation to the Tempo. For instance, if the Tempo is 120 and we come to a Relative Tempo mark of 50%, the playback tempo will slow down to 60. However, the Tempo display will not change.

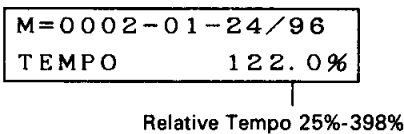

Relative Tempo can be set from 25% to 398% in 127 exponential steps. When Clock=Tape or MIDI, Relative Tempo marks will be ignored.



## ***Measure***

This mark is at the end of each measure. It can be moved back and forward in time. For 4/4 time, the first Measure mark would be as follows (the end of each measure is the hypothetical "5th" beat).

M=0001-05-00/96
MEASURE

Moving a Measure mark a little toward the beginning (ie. slightly shortening the length of one measure) is great for simulating a skipping record.(1)

# MEASURE EDIT

This is where you perform operations on specified measures of track 1. In each job, the upper right corner will display the amount of free memory (in 80 note blocks), max 250 blocks. The lower line of the display will show which measures will be affected by the operation. To enter this mode, press **[SHIFT]** + **[MEAS EDIT]**.

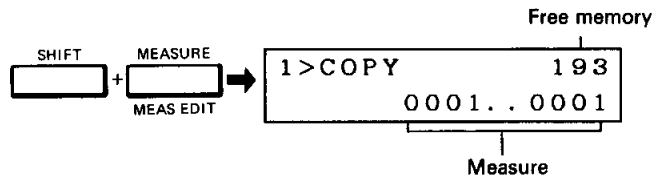

Measure Edit has 10 jobs.

Select the job you want by pressing **[JOB]**. **[SHIFT]** + **[JOB]** will step backwards.

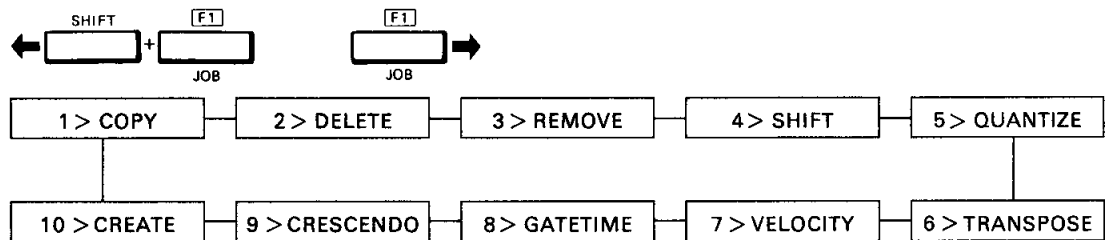

## Set Parameters

Press **[CURSOR]** to move the blinking cursor to the data you want to change, and use **◀▶** to change the data. Pressing **[CURSOR]** + **[SHIFT]** will move backwards.

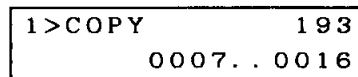

## Execute

Once you have specified the operation, you need to Execute by pressing **[ENTER]**. The display will show "Executing" for a few seconds.

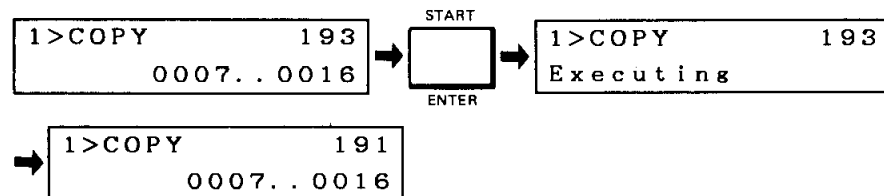

As the above example shows, some operations will affect the amount of Free Memory.

## 1. COPY

Copy the specified measures to the end of the track. You cannot set the second measure before the first.

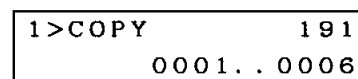

If you executed the above example, the track would change as follows.



---

## 2. DELETE

Delete the specified measures. Later measures are moved forward.

```
2>DELETE      1 9 1
              0 0 0 7 . . 0 0 1 6
```

If you executed the above example, the track would change as follows.



---

## 3. REMOVE

Remove a selected type of data from the specified measures.

```
3>REMOVE      1 9 1
P. BEND 0 0 0 6 . . 0 0 1 5
```

You can Remove the following data. Use ◀▶ to select the type of data you want to Remove.

CH	Messages of a certain MIDI channel (See below)
NOTE	Notes in a certain range (See next page)
VEL	Velocity data (all notes will be given a velocity of 64).
A.T.	Aftertouch data (Individual and Common).
P.BEND	Pitch Bend data.
CNTL	Control Changes in a certain range (see next page).
MODE	Mode messages.
PROG	Program Changes
EXCL	System Exclusive messages
MACRO	Macro numbers
TEMPO	Relative Tempo changes
ALL	Everything (blank measures will remain)

### *Remove Channel*

When you select Channel data to be Removed, the cursor will move two "additional" spaces, allowing you to select the range of channel data to be deleted.

```
3>REMOVE      1 9 2
CH           0 0 0 1 . . 0 0 1 5
```

```
3>REMOVE      1 9 2
CH           0 2   0 4
```

Channel 1-16

If you executed the example above, all data on MIDI channels 2-4 would be deleted from measures 1-15 of track 1.

### Remove Note

When you select Note data to be Removed, the cursor will move two "additional" spaces, allowing you to select the range of notes to be deleted.

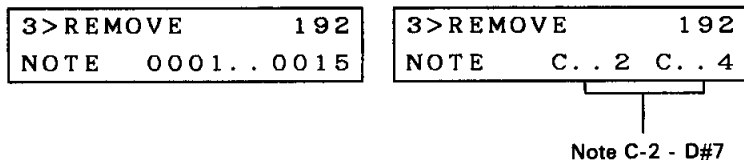

If you executed the example above, all notes between C2 and C4 would be deleted from measures 1 through 15 of track 1.

### Remove Control

When you select Control data to be Removed, the cursor will move two "additional" spaces, allowing you to select the range of Control data to be deleted.

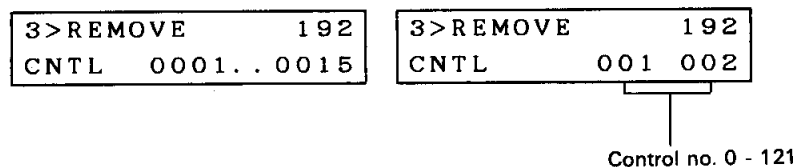

If you executed the example above, all Modulation Wheel and Breath Controller data (control changes 1 and 2) would be deleted from measures 1 through 15 of track 1. See the table of Control Change numbers on p. 22.

---

## 4. SHIFT

You can change all data of a certain type in specified measures. (For shifting all specified data in an entire track, see Track Edit, Shift p. 33.) You can shift Channel, Note, Control or Macro data.

### Shift Channel

Shift all data of a specified MIDI channel to another channel.

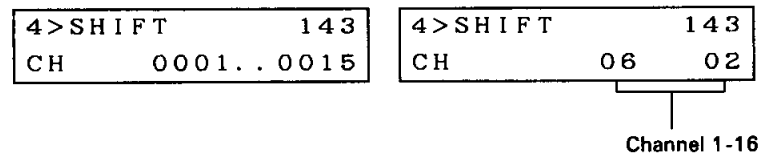

If you executed the above example, all data on MIDI channel 6 would be shifted to MIDI channel 2 for measures 1-15.

### Shift Note

Shift a specified note to another note.

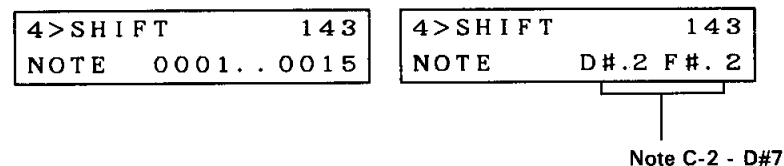

If you executed the above example, all D#2 notes would be shifted to F#2 for measures 1-15. This function is especially useful when using Note On messages to trigger an RX rhythm programmer. The example above would shift all Rim Shots (D#2) to Claps (F#2). See your RX manual for the Instrument Note Numbers.

### Shift Control

Shift a specified control change to another control change.

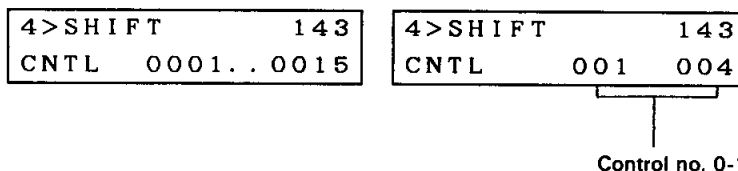

If you executed the example above, all Modulation Wheel messages (control #1) would be Shifted to Foot Controller messages (control #4) for measures 1-15. See the table of Control Changes on p. 22.

### Shift Macro

Shift a specified Macro number to another Macro number.

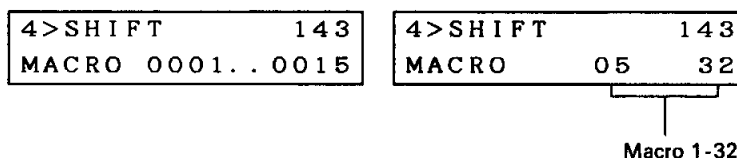

If you executed the above example, Macro 5 would be shifted to Macro 32 for measures 1-15. For example, suppose Macro 5 was a drum roll and Macro 32 was a harp glissando. A certain track calls Macro 5 in several places, but you want to change each drum roll to a harp glissando. Simply specify "MACRO 05 32."

---

## 5. QUANTIZE

Use this to adjust the timing of each event to the nearest specified step. This lets you "tighten up" performances you recorded in Realtime.

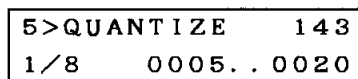

Timing precision 1/2 - 1/96

If you executed the above example, all events in measures 5-20 would be moved to the nearest eighth note. If you want to Quantize only notes, Extract the notes (p. 32), Quantize them, and re-combine the two tracks (Track Down, p. 31).

---

## 6. TRANSPOSE

Use this to move all note numbers up or down by a specified interval of up to 2 octaves. Notes are limited C-2-D#7.

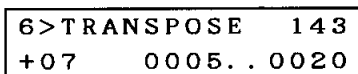

Interval -24 - +24

If you executed the above example, all notes in measures 5-20 would be transposed up a fifth.

---

---

## 7. VELOCITY

Use this to add or subtract a specified value to the velocity of all notes.

```
7>VELOCITY 143
+20 0005. . 0020
```

Velocity offset -99 - +99

If you executed the above example, all notes in measures 5-20 would be played somewhat more strongly. However, velocity is limited to 1-127.

---

---

## 8. GATE TIME

Use this to adjust the gate time (how long the note is held) for all notes. The original gate time is multiplied by the number you enter (10%-300% in steps of 5%).

```
8>GATE TIME 143
120% 0005. . 0020
```

Gate Time 10%-300%.

If you executed the above example, all notes in measures 5-20 would be held somewhat longer. Gate Time is limited to 16380 clocks.

---

---

## 9. CRESCENDO

Use this to gradually change the velocity. Over the measures that you specify, an increasing number is added to (or subtracted from) the velocity until the velocity bias you specify is reached on the last measure.

```
9>CRESCENDO 143
+50 0005. . 0020
```

Final velocity bias -99 - +99

If you executed the above example, the notes would be played with increasing force from measure 5, and when the end of measure 20 is reached, the velocity would be 50 higher than originally recorded. (However, the velocity is limited to 1-127.)

---

---

## 10. CREATE

Use this to insert empty measures of a specified time signature. Following measures are pushed back.

```
10>CREATE 143
4/4 0003. . 0005
```

Time signature 1/4 - 32/16

If you executed the example above, the track would change as follows.



# TRACK EDIT

This is where you perform operations on whole tracks and macros. To enter this mode, press **SHIFT** + **TRACK EDIT**. In each job, the upper right corner will display the amount of free memory (in 80 note blocks), and the amount of memory occupied by each track or macro is displayed in parentheses "( )". If the memory size is greater than 99, 99 is displayed.

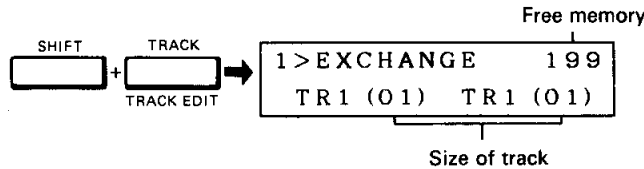

Track Edit has 10 jobs.

Select the job you want by pressing **JOB**. Pressing **SHIFT** + **JOB** will step backwards.

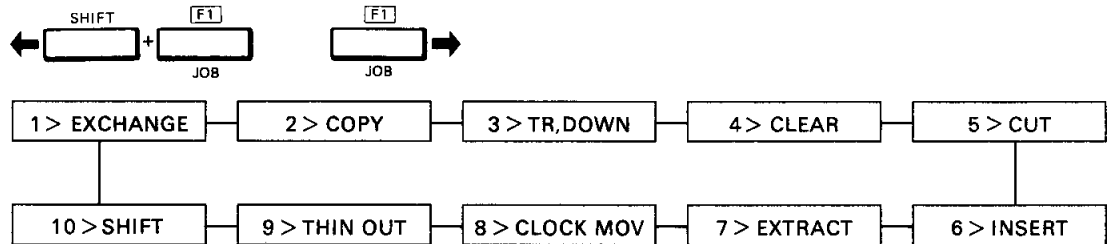

## Set Parameters and Execute

As explained in Measure Edit (p. 25), press **CURSOR** to move the blinking cursor to the data you want to change, use **◀▶** to change the data, and press **ENTER** to execute the operation.

## 1. EXCHANGE

You can freely swap the contents of tracks 1-8 and macros 1-32. Use the **CURSOR** and **◀▶** keys to select what you will exchange.

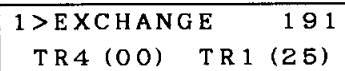

When you have finished recording, you will usually want to Exchange track 1 (the newly recorded track) with an empty track.

## 2. COPY

Copy the contents of a track or macro to another track or macro. The old data in the copy destination will be lost.

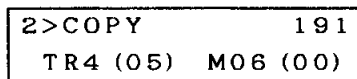

Original Track    Destination  
or Macro

---

---

### 3. TR. DOWN

Track Down (mix) the contents of two tracks. The contents of both tracks will be put into the second track. If the measure markings of the two tracks are different (eg. one is in 3/4 time and the other is in 4/4 time), the measure markings of the lower numbered track will be used.

```
3>TR. DOWN      1 9 1
  TR1 (05)  TR2 (08)
```

---

---

### 4. CLEAR

Erase the contents of a track or macro.

```
4>CLEAR          1 9 1
                TR4 (25)
```

---

---

### 5. CUT

This cuts track 1 at the beginning of the specified measure, and puts the deleted part in another track (2-8). If DELETE is selected instead of track 2-8, the deleted part will be discarded. The old data in the specified track (2-8) is lost.

```
5>CUT           1 9 1
0007           TR2 (03)
```

Measure

Executing the above example would Cut track 1 at measure 7 and put the "tail" in track 2.

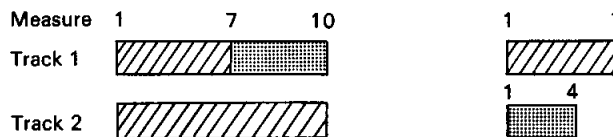

---

---

### 6. INSERT

Insert track 1 into another track (2-8) in front of the specified measure. Track 1 remains the same.

```
6>INSERT        1 9 1
0007           TR2 (03)
```

Measure

Executing the above example would change the tracks as follows.

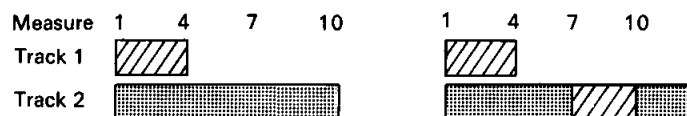



---

---

## 7. EXTRACT

Extract specified data from track 1 and put it in another track (2-8). If DELETE is selected instead of track 2-8, the extracted data will be discarded. The extracted data is removed from track 1. Use the ◀▶ key to specify Channel, Note, Pressure, Pitch Bend, Control Change, Mode Message, Program Change, Data, Macro, Tempo or Measure.

```
7>EXTRACT      1 9 1
P. BEND      TR 8 (02)
```

Executing the example above would remove Pitch Bend data from track 1 and put it in track 8. (Track 8 now contains only Pitch Bend data.)

You can Extract the following data. Use ◀▶ to select the type of data you want to Extract.

CH	Messages of a certain MIDI channel (see Note 1).
NOTE	Notes in a certain range (see Note 1).
A.T.	Aftertouch data (Individual and Common).
P.BEND	Pitch Bend data.
CNTL	Control Changes in a certain range (see Note 1).
MODE	Mode messages.
PROG	Program Changes
EXCL	System Exclusive messages
MACRO	Macro numbers
TEMPO	Relative Tempo changes
MEASURE	Copy measure marks to other track (see Note 2).

### NOTE 1

When Extracting Channel, Note or Control, the cursor has two "additional" spaces to move as explained in Measure Edit (p. 26).

```
CH   01 - 16   Channels to be extracted
NOTE C.-2- D#.7 Note range to be extracted
CNTL 000 - 121 Controls to be extracted
                (see control number table on p. 22)
```

### NOTE 2

When Extracting Measure, track 1 Measure Marks are not erased. The selected track will contain an empty framework of Measure Marks from track 1. This is useful when you have built up a complex rhythmic part in track 1 with changing time signatures, and wish to copy only the measure framework. (For more about changing time signatures, see Measure (p. 24) and Beat/Measure (p.38).

---

---

## 8. CLOCK MOVE

Move the timing of one track (1-8) forward or backward by up to 999 clocks.

```
8>CLOCK MOV  1 9 1
+048      TR 3 (07)
```

If you executed the above example, the entire track 3 would move forward an eighth note (48 clocks).

If you moved the track backwards (-048), the data within the first 48 clocks would be deleted.

---

---

## 9. THIN OUT

Delete about half of the selected Continuous Control message from a selected track (1-8). You can select Aftertouch (Individual and Common), Pitch Bend or Control Change (continuous controls).

9>THIN OUT	191
A. T.	TR2 (17)

If the above example were executed, about half the Aftertouch messages in track 2 would be deleted.

Especially when you move a controller slowly, many messages with very similar data will be sent. You can usually delete half of them without any audible difference. If you are running low on available space, this can help. Repeating this operation several times will eventually produce "rough" change (which can be an interesting effect).

---

---

## 10. SHIFT

Shift all specified data in a track (1-8). You can specify Channel, Note, Control Change or Macro. Set parameters and Execute in the same way as explained in Measure Edit Shift, p. 27.

### *Shift Channel*

10> SHIFT	191
CH	TR5 (09)

10>SHIFT	191
CH	01 14

If you executed the above example, all MIDI channel 1 messages in track 5 would be shifted to channel 14.

### *Shift Note*

10>SHIFT	191
NOTE	TR5 (09)

10>SHIFT	191
NOTE	D#. 2 F#. 2

### *Shift Control*

10>SHIFT	143
CNT	TR5 (09)

10>SHIFT	143
CNTL	001 004

### *Shift Macro*

10>SHIFT	143
MACRO	TR5 (09)

10>SHIFT	143
MACRO	05 32

# LOAD / SAVE

This is where you load and save sequence data, and store and recall QX5 setups. To enter this mode, press **SHIFT** + **LOAD/SAVE**.

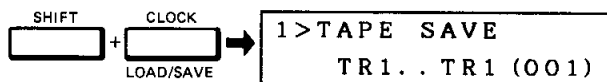

Load/Save has 7 jobs.

Press **JOB** to select the function you want. **SHIFT** + **JOB** will step backwards.

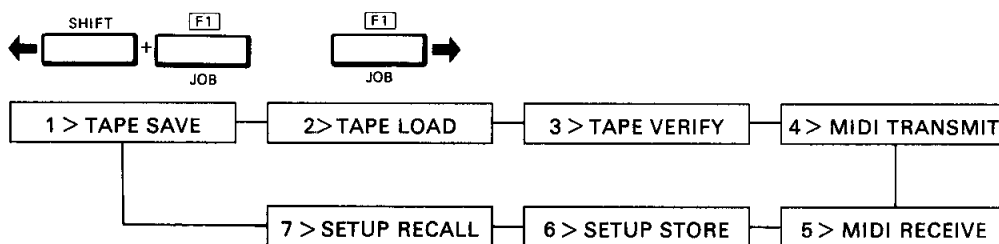

## 1. TAPE SAVE

As shown below, using the included cable, connect the QX5 Tape In to the earphone jack of a cassette recorder. Connect Tape Out to the microphone jack. It is best to use a cassette recorder and tape especially designed for personal computer data storage.

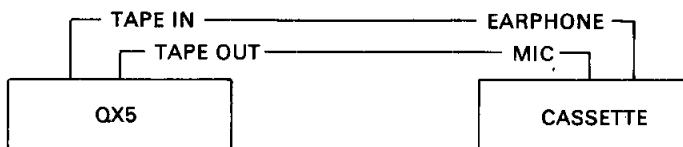

### Save Which Tracks and Macros?

Press **LOAD/SAVE** while pressing **SHIFT**. Use **CURSOR** and **◀▶** to select which tracks and macros you are going to save. To save all tracks and macros you would select "TR1..M32". The number at the right indicates the size (in blocks of 80 notes) of the data you are saving. If empty tracks or macros are specified, they are simply skipped.

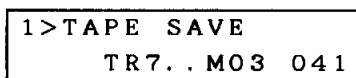

Save from .. to      Total size of memory to be saved

## Execute Save

The above display would save tracks 7 and 8, and macros 1-3. Start the cassette record and press **START**. The display will show "Executing" for a few seconds while it sends a header. Then the display will show the track or macro currently being saved. When saving is complete, the display will show "Completed" for a second. (While saving, you can abort by pressing **SHIFT** + **RESET**.)

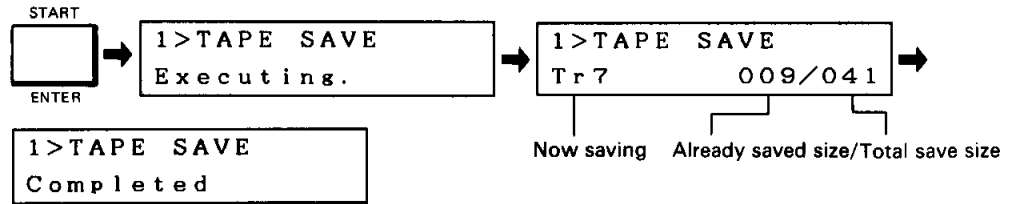

---

## 2. TAPE LOAD

To load data that has been saved to tape, connect the cassette recorder and QX5 as described above. Use **<>** to specify how the data will be loaded.

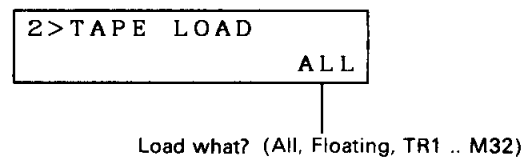

### Load All

All data in QX5 memory will be erased, and whatever is on tape will be loaded into the track or macro it came from. (Saved data includes this information.) Tracks and macros that did not receive data from tape are cleared.

### Load Floating

If possible, received data is loaded into the track or macro it came from. However, if the original track or macro already contains data, the tape data will be loaded into whatever empty track or macro is available. Tracks and macros that did not receive data from tape retain their old data. If there are no more empty tracks or macros, the data will be ignored.

### Load TR1..M32

Here you can specify what part of the incoming data you will receive. (Track 1 to Macro 32.) All other data will be ignored. Use **CURSOR** and **<>** to select start and end. If data is not received for a track or macro, the original data is preserved.

### Execute Load

When you have specified how you will load the data, press **START**. The display will show "Executing". Start the tape playback. When the QX5 finds the beginning of the data, it will display the current track or macro being loaded, and the total size of data loaded so far. When loading is complete, the display will show "Completed" for a second

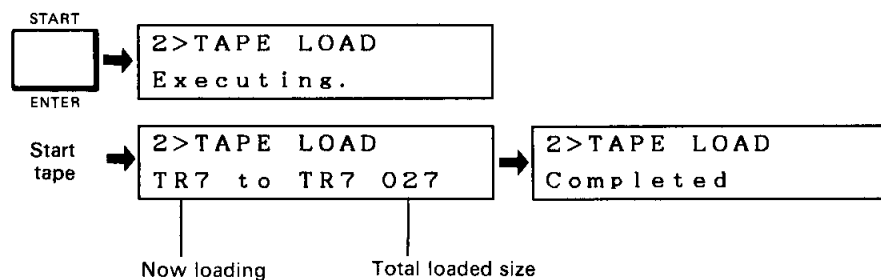

If you have specified certain tracks and macros to be loaded, the display will show "Ignored" while skipping over the unwanted data.

### 3. TAPE VERIFY

This is where you can check that data was correctly saved to tape. Press **[START]**. The display will show "Executing." Rewind the tape to the beginning of the saved data, and play it back. When data is found, the display will show the found track or macro, and the total data size so far. When finished, the display will show "Completed" for a second.

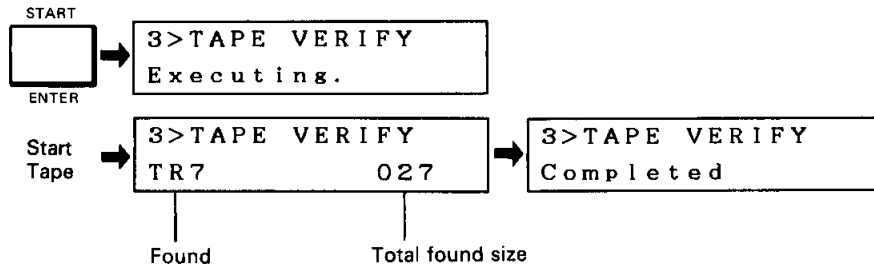

#### NOTE

Tape Verify does not compare the internal memory with the data from tape. It only checks to see that the tape contains readable data, and that the checksum is correct.

### 4. MIDI TRANSMIT

This is where you can transmit QX5 sequence data in the form of a System Exclusive message to an external data managing device or another QX5. (See p. 50 for the data format.) MIDI transmit is much faster than saving to tape, and it takes about 50 seconds to transmit the entire contents of a QX5 when it is full (0 free memory). You can specify the MIDI channel on which the data will be sent. (Strictly speaking, a System Exclusive message has no channel, but this is a channel or Device Number within Yamaha System Exclusive format.) The Device Number of the QX5 (see p. 45) will initially be set as the Transmit Channel, but you are free to change this. Select the tracks and macros to be sent in the same way as with Tape Save (p. 34). The total size of the data to be sent is displayed in the lower right. You can transfer sequence data from a QX7/21 to a QX5, but not vice versa.

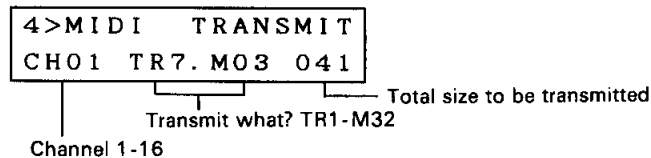

When you press **[START]**, the display will show "Executing", and then show the track or macro currently being sent, just as in Tape Save. When finished, the display will show "Completed" for a second. (While Transmitting, you can abort by pressing **[SHIFT]** + **[RESET]**.)

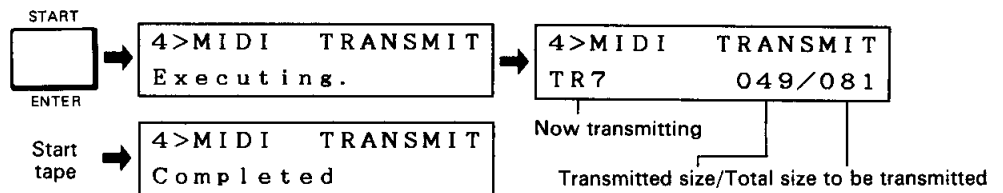

---

## 5. MIDI RECEIVE

This is where you can receive QX5 sequence data in the form of a MIDI System Exclusive message from an external data managing device or another QX5/7/21. As with MIDI Save, you can specify the channel. (The transmission and reception channels must match, or the data will not be received.) As with Tape Load, you can specify how the data is to be loaded (see p. 35).

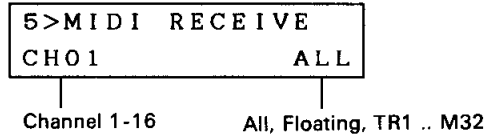

When you press **[START]**, the QX5 will send a Dump Request message and wait for Sequence Bulk data to come. When the data begins arriving, the display will show the track or macro being received, just as in Tape Load (p. 35).

---

## 6. SETUP STORE

You can store most of the QX5 settings in one of 4 memories for quick recall. A Setup Memory contains all settings in Setup (p. 38), MIDI 1 (p. 41) and MIDI 2 (p. 44). In addition, it contains the Clock In and Out settings (Int, MIDI or Tape). It does not contain Tempo and Measure Memories or Track On/Off settings. To store the current settings in a Setup Memory, use **<▶** to select the memory number (1-4) and press **[START]**. After briefly displaying "Executing", the current setup will be saved in the specified memory. There is a Setup Memory chart on p. 40.

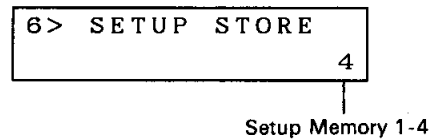

---

## 7. SETUP RECALL

Use this to recall a setup you have saved in Setup Store. Use **<▶** to select the setup you want (1-4) and press **[START]**. The setup will be recalled into memory.

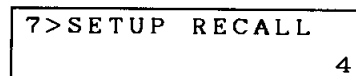

---

---

# SETUP

---

---

This is where you change various settings of the QX5. Settings you make are remembered even when the power is turned off, and four different setups can be stored and recalled (see p. 37). To enter this mode, double-click **TEMPO**.



There are 6 jobs in Setup. Move through them by pressing **JOB**, or **SHIFT** + **JOB** to move back.

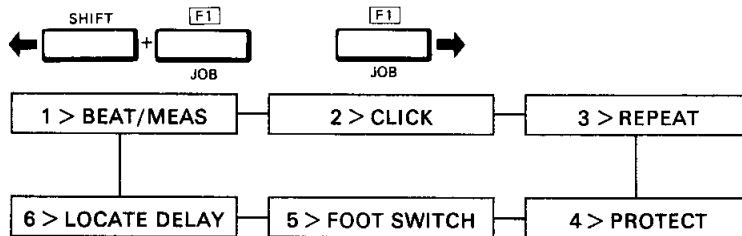

---

## 1. BEAT/MEASURE

This is where you set the time signature. If you are recording with no other tracks playing back, this time signature is what determines how Measure Marks are recorded. Beat/Measure also will determine how the metronome sounds (see Click, below).

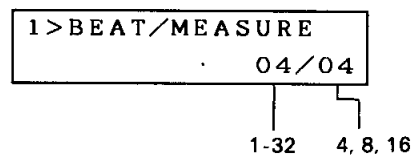

---

## 2. CLICK

You can set the metronome to sound during recording and playback, only during recording, or to be turned on and off manually (by pressing **SHIFT** + **CLICK**). In any setting, you can always turn it on/off by pressing **SHIFT** + **CLICK**. There will be an accent on the first beat of the measure.

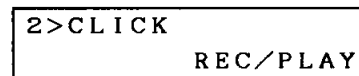

Manual, Record, Rec/Play

---

## 3. REPEAT

When Repeat is on and the song reaches the end during playback, it will start again from the beginning.



Off/On

---

---

## 4. MEM.PROTECT

When Memory Protect is on, you will not be able to edit or record. Turning the power on will not set Memory Protect on.

```
4>MEM. PROTECT
      OFF
```

Off/On

---

---

## 5. FOOT SWITCH

You can select the function that a foot switch connected to the rear panel jack will have. It will function exactly like the front panel **STOP/CONTINUE** and **START** switches

```
5>FOOT SWITCH
      CONTINUE/STOP
```

Start, Start/Stop, Continue/Stop

---

---

## 6. LOCATE DELAY

When Auto Locate (p. 16) is on and you Start, or if you move during playback using Measure (p. 13), the QX5 will send a MIDI Song Position message from MIDI OUT. This tells other devices (sequencers, rhythm machines etc.) where we are in the song. (ie. how many beats from the beginning.) Then the QX5 sends a MIDI Continue message. However, the other device will require a bit of time (a fraction of a second) to move to the specified point in the song before it can Continue. Locate Delay is the time between the Song Position message and the Continue message. Some devices will require a longer Locate Delay than others.

```
6>LOCATE DELAY
      100ms
```

100ms-990ms



## QX5 SETUP MEMORY CHART

All settings in Setup (p. 38), MIDI 1 (p. 41) and MIDI 2 (p. 44) can be stored in one of the 4 setup memories. For instance you could have different setups for recording and performing.

Copy this chart and use it as a note of each setup memory. Page 37 tells how to Store and Recall setup memories.

Setup No.

Notes	SETUP			
Beat/Measure	/			
Click	Manual	Record	Rec/Play	
Repeat	Off	On		
Mem. Protect	Off	On		
Foot Switch	Start	Start/Stop	Continue/Stop	
Locate Delay				
MIDI 1				
Input Assign	1 2 3 4 5 6 7 8 9 10 11 12 13 14 15 16			
Output Assign	1 2 3 4 5 6 7 8 9 10 11 12 13 14 15 16			
Velocity	Off	On		
Aftertouch	Off	On		
Pitch Bend	Off	On		
Control Change	Off	On		
System Exclusive	Off	On		
MIDI 2				
Remote In	Off	On		
Remote Out	Off	On		
Echo	Off	Direct	Rec.Monitor	
Device Number				
CLOCK				
Clock In	Int	MIDI	Tape	
Clock Out	Off	On		

Setup No.

Notes	SETUP			
Beat/Measure	/			
Click	Manual	Record	Rec/Play	
Repeat	Off	On		
Mem. Protect	Off	On		
Foot Switch	Start	Start/Stop	Continue/Stop	
Locate Delay				
MIDI 1				
Input Assign	1 2 3 4 5 6 7 8 9 10 11 12 13 14 15 16			
Output Assign	1 2 3 4 5 6 7 8 9 10 11 12 13 14 15 16			
Velocity	Off	On		
Aftertouch	Off	On		
Pitch Bend	Off	On		
Control Change	Off	On		
System Exclusive	Off	On		
MIDI 2				
Remote In	Off	On		
Remote Out	Off	On		
Echo	Off	Direct	Rec.Monitor	
Device Number				
CLOCK				
Clock In	Int	MIDI	Tape	
Clock Out	Off	On		

# MIDI 1

These settings determine what the QX5 will record, and how it will be played back. To enter this mode, double-click the **TRACK** switch.

(Press twice)



There are 7 jobs in this mode.

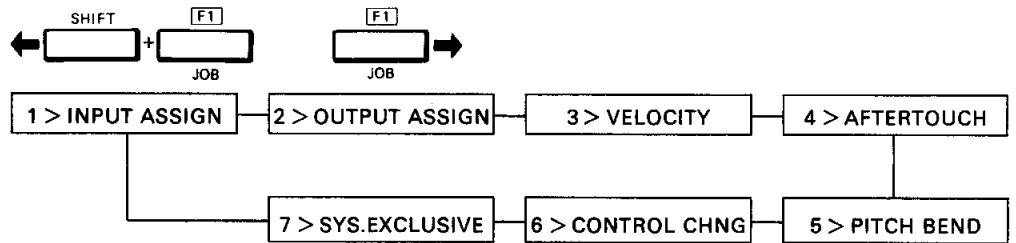

## 1. INPUT ASSIGN

This determines which channels the QX5 will accept, and on which channels they will be recorded on. Each place from left to right represents incoming MIDI channels 1-16. Each incoming MIDI channel can be turned off (indicated by a period), or "re-channelized" and recorded on another channel. Use **CURSOR** to move to the channel you want, and **◀▶** to change the assignment. By pressing **SHIFT** + **◀▶**, all channels to the right of the cursor will change together.

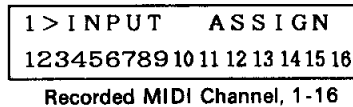

When set as shown above, each incoming MIDI channel will be recorded on its original channel. If you can change the output channel of your MIDI keyboard, it is easiest to leave Input Assign set as above, and switch output channels before recording each part.

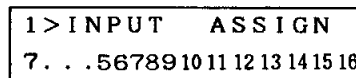

When set as shown above, incoming messages on channel 1 will be re-channelized to channel 7. Messages on channels 2-4 will be ignored, and messages on channels 5-16 will be accepted on their original channel.

### Multi-channel recording

When using the QX5 with more than one tone generator, the usual method is to set each tone generator to a different reception channel, so it can play a different part. Obviously, each part must be on a different MIDI channel. There are three ways to do this.

1. Send the messages from the keyboard on a different channel for each part using a keyboard with selectable output channel (such as the KX88). This is easiest and best.
2. After recording each part, use Shift Channel (Track Edit, p. 33) to change the channel. However, this will mean that you record listening to one tone generator, and playback listening to another tone generator, which can get confusing if each tone generator contains different voices.
3. Before recording each part, set Input Assign to re-channelize the incoming channel. If you have selected Echo Rec Monitor (p. 43), you will hear the same tone generator during recording and playback. When using a keyboard with fixed output channel, this is best.

---

## 2. OUTPUT ASSIGN

This determines the channels that the QX5 will transmit during playback. Make settings in the same way as for Input Assign.

2>OUTPUT ASSIGN
123456789 10 11 12 13 14 15 16

As set above, recorded data will be played back on the original channel. As an example of how you might use this function, suppose you had a bass part recorded on channel 3, and wanted to hear how it would sound played back on different tone generators. Changing the Output Assign would let you do this without affecting the recorded data. (You could do the same thing by changing the reception channel of the tone generators, but this might be easier.) When a channel is turned off (indicated by a period "."), data on that channel will not be played back.

---

## 3. VELOCITY

This determines whether the QX5 will record velocity data. If turned off, all velocity will be recorded with a fixed value of 64. If you really don't need velocity, turning it off will increase the memory capacity. (About 15,000 notes with velocity, 20,000 without velocity.)

3>VELOCITY	ON
------------	----

---

## 4. AFTERTOUCH

This determines whether the QX5 will record Aftertouch messages (Common and Individual Aftertouch). On an instrument where Aftertouch cannot be switched off, it is a good idea to turn this off if you don't need to record Aftertouch. Otherwise, the QX5 memory will quickly be filled up with Aftertouch messages. (The least bit of pressure on the keyboard will send an Aftertouch message.)

4>AFTERTOUCH	ON
--------------	----

---

## 5. PITCH BEND

This determines whether the QX5 will record Pitch Bend messages. As with Aftertouch, Pitch Bend messages can take up a lot of memory. One way to use this might be to record without Pitch Bend, and add the Pitch Bend later, perhaps to another track (but same MIDI channel).

5>PITCH BEND	ON
--------------	----

---

## **6. CONTROL CHANGE**

This determines whether the QX5 will record Continuous Control Changes (control numbers 0-63) such as Modulation Wheel, Foot Controller, Breath Controller, Volume, Portamento Time and Data Entry Slider. (See the list of Control changes on p. 22.)

6>CONTROL CHNG ON
----------------------

---

## **7. SYSTEM EXCLUSIVE**

This determines whether the QX5 will receive and record System Exclusive messages.

7>SYS. EXCLUSIVE ON
------------------------

System Exclusive messages will be recorded in the same way as Note and Controller messages. This means that if Sys.Exclusive is on, you can record Voice Parameter changes (such as EG Rate or Algorithm) sent from a KX88.

### **NOTE**

System Exclusive messages beginning with "F0, 43, 0n ..." or "F0, 43, 1n ..." or "F0, 43, 2n ..." are for the QX5 itself (bulk sequence memory). They will be loaded into QX5 sequence memory if the Device Number "n" matches the QX5 device number (p. 44). If the QX5 device number is OFF, all System Exclusive messages will be recorded in the usual way.
---

---

---

# MIDI 2

---

---

These settings determine how the QX5 will react to and re-transmit (Echo) MIDI messages, and set the QX5's Device Number. To enter this mode, double-click the **CLOCK** switch.



There are 4 jobs in this mode.

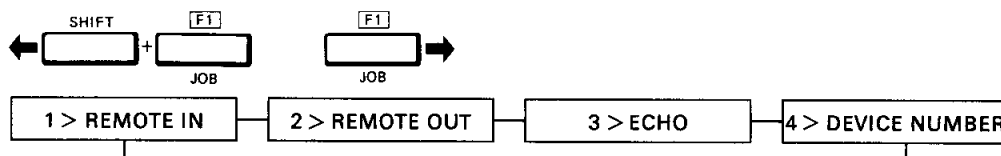

---

---

## 1. REMOTE IN

This determines whether the QX5 will receive Song Position, Song Select, Start, Continue and Stop. (MIDI Clock reception depends on the Clock setting, p. 14.)

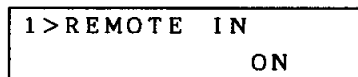

You will usually want to leave this ON. (Some reasons for turning it off might be to let the QX5 keep on playing even after another sequencer had stopped, etc., but this will not occur in most uses.)

---

---

## 2. REMOTE OUT

This determines whether the QX5 will transmit Song Position, Song Select, Start, Continue and Stop.

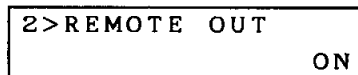

As with Remote In, you will usually want to leave this ON, so that other sequencers or rhythm machines can be synchronized with the QX5.

---

---

## 3. ECHO

This determines whether Channel messages and System Exclusive messages received at MIDI IN are sent from MIDI OUT. System Exclusive messages for the QX5 itself (System Exclusive Bulk Sequence Data with sub-status 0,1 or 2) are not Echoed back. Also, System Common messages and System Realtime messages are not Echoed back.

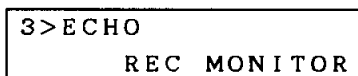

Off, Direct, Rec Monitor

- \*Echo Off: Messages received at MIDI IN are not sent from MIDI OUT.
- \*Echo Direct: Messages received at MIDI IN are sent unchanged from MIDI OUT. (MIDI OUT acts as MIDI THRU.) However, received messages are passed through the Key Assign Table (see note). When an All Note Off message is received, the Key Assign Table is searched to see if any notes are still on. If there are, Note Off messages are sent for each of them.
- \*Echo Rec Monitor: Messages received at MIDI IN are passed through Input/Output Assign to be re-channelized or ignored (p. 41) and through the Status Filters (p. 41, Velocity, Aftertouch, Pitch Bend, Control Change, System Exclusive). In this way, you can hear exactly what you are recording.

**NOTE**

The QX5 has a 32 note Playback Key Assign Table that keeps track of which notes are currently on. This means that there can be no more than 32 notes simultaneously on during playback. Likewise, there is a 16 note Record Key Assign Table.

---

## **4. DEVICE NUMBER**

This is the "System Exclusive MIDI reception channel" for the QX5 itself. When incoming Sequence Bulk Data has a matching device number and a sub-status of 0, 1 or 2, it will be received into QX5 system memory. All other incoming System Exclusive messages will be recorded as usual. The QX5 itself receives two types of System Exclusive message; Sequence Bulk data, and Dump Request.

4>DEVICE NUMBER  
0 1

OFF 1-16

---

---

## OTHER FUNCTIONS

---

---

---

---

### CLICK

Pressing **[SHIFT]** + **[CLICK]** will turn the metronome on or off at any time. Using the Setup function **[CLICK]** (p. 38), you can have the metronome automatically sound during record and playback. By connecting the back panel Click Out to an amp/speaker or mixer, you can hear the click through your monitor system or headphones. When the back panel Click Out is used, the internal click will not sound.

---

---

### RESET

Pressing **[SHIFT]** + **[RESET]** will do the following.

- \* If pressed during playback, play will stop (just as if you had pressed **[STOP]**).
- \* If pressed while transmitting or receiving data (tape or MIDI), transmission or reception will stop.
- \* If pressed in Setup, Edit or Load/Save modes, it will return to Tempo, Measure, Track or Clock mode.
- \* If pressed while in Tempo, Measure, Track or Clock modes, Song Position will be reset.

---

---

### MIDI MONITOR

This lets you see on what MIDI channel messages are being received and transmitted. Double-click **[MEASURE]**. When a message is received or transmitted, the channel number will be displayed for 0.5 seconds. Press **[JOB]** to select Input or Output monitor.

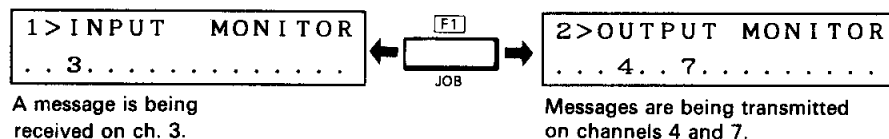

---

---

### LOOP PLAYBACK

When Auto Locate is on, press **[SHIFT]** + **[START]** during playback. Playback will continue in a loop between the Auto Locate measure memory (p. 13) and the point at which you pressed **[SHIFT]** + **[START]**.

---

---

# TAPE SYNC

---

---

The QX5 can be synchronized with a multi-track tape recorder such as the MT1X. One track of tape is used to record and play back an FSK (Frequency Shift Keying) sync signal. When you playback the QX5, an FSK sync signal is sent to the tape recorder. When the QX5 is set to Tape Clock and you playback the tape, the QX5 receives this FSK sync signal, and plays the sequence back in synchronization with the tape.

In the same way, you can record on the QX5 while synchronized to tape. Press **RECORD**, then **START** or **CONTINUE**, before you start the tape. When you start the tape, recording will begin.

## Connections

Connect the tape recorder to the QX5 Tape In/Out jacks as shown.

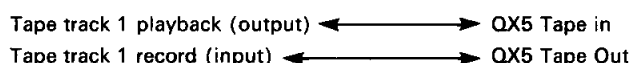

## Recording the Sync Track

Set the QX5 to Internal Clock.  
Begin recording on tape track 1.  
Start QX5 playback.  
When the QX5 playback is over, stop the tape.

## Synchronized Playback

Set the QX5 to Tape Clock.  
Press **START** or **CONTINUE**.  
Rewind the tape to a point before the sync starts, and playback track 1.  
The QX5 will start playing in synchronization with the tape.

## NOTE

- \* Before playback, be sure to rewind the tape to a bit before the point where the sync signal starts.
- \* The FSK signal contains only Timing Clock data. You must press **START** or **CONTINUE** and **STOP** on the QX5.
- \* If you are experiencing difficulty, check the recorded level of the FSK signal

## Example

Yamaha MT1X has SYNC IN/OUT terminals for FSK recording and playback.

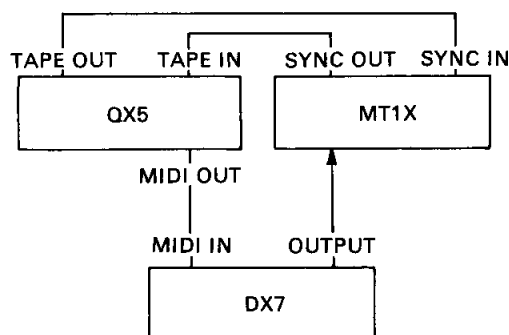

1. Record the FSK signal via the SYNC IN of MT1X. (It will be recorded on track 1.)
2. At the same time, record the DX audio signal played back by the QX5 on MT1X track 2.
3. Change the DX voice. Synchronizing the QX5 to the tape, record another sequence playback on MT1X track 3.
4. In the same way, record MT1X track 4.



---

---

## IDEAS AND SUGGESTIONS

---

---

- \* Since the QX5 requires so little power, you may want to leave it on whenever you practice, to serve as a quick notebook to capture your musical ideas. A riff or motif can be stored in a macro, to leave the tracks free for recording.
- \* You can use the QX5 to save and load voice bulk data to and from tape. Set the QX5 to accept System Exclusive messages. Start realtime recording and dump the data. (See the owner's manual for the other device.) When the data has been completely sent, stop recording and save track 1 to tape.
- \* By setting the DX7 to Sys Info Avail, you can store voice data as part of a sequence. Set the QX5 device number OFF, and Voice Data Bulk Dump will be recorded along with other messages. Set the DX7 to Sys Info Avail. Every time you select a DX voice, instead of a Program Change, the voice data will be sent out. This means you can play back a sequence without using any of the voices originally in a tone generator. (ie. not Program Changes, but the actual voice data is sent into the tone generator edit buffer during playback.)
- \* Recursive macros! You can call a macro from another macro, and even call it from itself (at the end). This could be used for a repeating phrase. (It will continue playing till all playing tracks ends.)
- \* The KX88 or MCS2 have front panel sliders that can be assigned to send MIDI Tempo Clock. This is quicker than using the QX5 ◀▶ switches to change tempo.
- \* Set aside Track 1 for recording and editing. As soon as you have finished working on a track, Exchange it with an empty Track or Macro. This will avoid accidents, and help you keep track of what data is where.
- \* You may have to go through a few steps, but if you stop to figure it out, almost any imaginable editing operation is possible. For instance, Bass, Piano and Strings are all in one track (on different channels, of course), but you decide to re-do the Bass. Extract the channel the Bass is on. Re-record the Bass, and Track Down to combine the three parts back into one track.
- \* A song in each track. If you are performing live and need to have instant access to 8 different songs, put one in each track. Play back each song with the other tracks turned off.
- \* Quantize only notes. The Quantize function affects all events, which sometimes can have unwanted side effects. For instance, if a Program Change comes at the same moment as a Note On, the Note On will not have time to sound correctly. To avoid problems, Extract the Note data, Quantize it, and Track Down to put it back in the original track.
- \* Allow for mistakes. when performing a potentially dangerous function (such as Quantize or Remove), Copy the original data to a Macro. That way if you make a mistake, you still have the original data.

---

---

# MESSAGES

---

---

---

---

## ERROR MESSAGES

When there has been an error or some unexpected condition, the QX5 will display the error numbers and messages as follows.

```
* ERROR-03 *  
MIDI buffer over
```

Error No.	Message	Meaning
01	Clock too-fast	The buffer for realtime messages (Clock, Start, etc.) has overflowed.
02	Out of sync	Unable to STOP normally, (Too much data, or tempo too fast).
03	MIDI buffer over	The input buffer has overflowed.
04	MIDI data error	Input data error.
05	Memory full	During record, edit or data loading, the memory has overflowed.
06	Memory Protected	You tried to record, edit or load when Memory Protect was on.
07	TR1 not ready	You tried to record or enter Event Edit when track 1 was off.
08	Memory error	The battery backed-up data is incorrect.
09	Illegal format	Data loaded from MIDI or tape has incorrect format. (Wrong number of bytes or check sum error).
10	Bad tape level	Unable to load from tape.

---

---

## WARNING MESSAGE

During recording, if free memory goes below 009, this message will be displayed. Press any switch to go back to the previous display.

```
* WARNING *  
Memory near full
```

---

---

## DATA MESSAGES

If Sequence Bulk data is transmitted (in response to a dump request) or received while not in Load/Save mode, the following messages will be displayed. When finished, the display will show "Completed" for 1 second. You can press **[SHIFT]** + **[RESET]** to abort, in which case the display will show "Aborted". The displayed numbers are explained in Tape Save and Tape Load (p.34-p.35).

```
* TRANSMIT *  
TR1      018/134
```

```
* RECEIVE *  
TR5 . TR5      042
```

---

---

# SYSTEM EXCLUSIVE DATA FORMAT

---

---

In addition to System Exclusive messages recorded as sequence data, the QX5 transmits and receives the following data.

---

---

## TRANSMISSION DATA

1. When MIDI Transmit (p. 36) is executed, Sequence Bulk data is sent as

MIDI Status byte	F0	(System Exclusive)
ID	43	(Yamaha)
Sub-status/Device no.	0n	(0=Bulk dump, n=device number 0-F)
Format no.	0A	(Sequence data)
Data blocks (see below)	...	
EOX	F7	(End of Exclusive)

The sequence data has been converted into ASCII format by sending the upper and lower nibbles separately. When a large amount of data is sent, it is divided up so that the byte count is 4096 or less, and sent in blocks as described below. Each block has its own byte count, header and check sum. There must be an interval of 100 msec at the end of each block to allow the QX5 to process the data. After all blocks have been sent, F7 (EOX) is sent. Each data block has the following format.

Byte count	??	(High; 00-7F)	Byte count of header + sequence data
Byte count	??	(Low; 00-7F)	
Header	'L'M' 'N'S'E'Q'1'	(ASCII "LM NSEQ1 ")	
Sequence data	...	Number of bytes indicated in Byte Count	
Check sum	??	(00-7F)	Check sum of Header + Sequence data

100 msec interval (to allow the QX5 to process the data)

2. When MIDI Receive (p. 37) is executed, a dump request is sent as follows.

MIDI Status byte	F0	(System Exclusive)
ID	43	(Yamaha)
Sub-status/Device no.	2n	(2=Bulk data, n=device number 0-F)
Format no.	0A	(Sequence data)
EOX	F7	

---

---

## RECEPTION DATA

When the QX5 receives a dump request as above with the appropriate device number, it will transmit Sequence Bulk data in the same format described in 1.

### NOTE

This is how sequence data is stored in the QX5 internal memory. When sending it as part of a bulk dump, each byte is converted into ASCII format by sending the upper and lower bytes separately.

F0	Top of record
nn	Record number 0: TR1, 1: TR2,... 8: M01, 9: M02... 39: M32
dd	Sequence data
....	
dd	
F2	End of record

The data for one track or macro begins with F0 and ends with F2. The byte after F0 is the track number. If there is more than one track being sent, the above data is sent successively. The track beginning and end has no relation to the beginning and end of data blocks.

---



---

**RECEPTION/  
TRANSMISSION  
CONDITIONS**

The QX5 does not have to be in Save/Load mode to receive or transmit Sequence Bulk data.

- When a Dump Request is received, the QX5 transmits all data TR1 – M32.
- When Sequence Bulk data is received, it is loaded into TR1 – M32. Track and macros not receiving data preserve their original data.
- Data is received only if the device number matches.
- During playback, recording or editing, incoming Dump Requests and Sequence Bulk data are ignored.

---



---

**SPECIFICATIONS**

---



---

CAPACITY .....	Approximately 20,000 notes (15,000 notes with velocity)
SWITCHES.....	TEMPO, MEASURE, TRACK, CLOCK, DISPLAY, AUTO LOCATE, F1, F2, F3, F4, SHIFT, RECORD, STOP/CONTINUE, START
LED .....	TEMPO, AUTO LOCATE, RECORD, START
DISPLAY .....	16 Character 2 Line Backlit LCD
TERMINALS .....	MIDI IN, MIDI OUT, MIDI THRU, TAPE IN, TAPE OUT, CLICK, FOOT SWITCH
POWER CONSUMPTION .....	5 W
DIMENSIONS (W x D x H).....	350 x 240 x 49 mm (13-3/4" x 9-3/8" x 1-7/8")
WEIGHT .....	2.9 kg (6 lbs 6 ozs)
INCLUDED ITEMS .....	MIDI cable (1m) x 2 Cassette cable x 1 (for Data recorder) Pin cable x 1 with Plug adapters (for Tape sync.)

Function ...	Transmitted	Recognized	Remarks
Basic Default Channel Changed			X5
Mode Default Messages Altered	POLY, MONO(M=1) XXXXXXXXXXXXXXXXXXXX	POLY, MONO(M=1)	X1
Note Number : True voice	0-111 XXXXXXXXXXXXXXXXXXXX	0-111 0-111	X1
Velocity Note ON Note OFF	o 9nH, v=1-127 x 9nH, v=0	o X2(VELOCITY) x	X1
After Touch Key's Ch's	o o	o X2(AFTER TOUCH) o X2(AFTER TOUCH)	X1 X1
Pitch Bender	o	o X2(PITCH BEND)	X1
Control Change	0-63 o	o X2(CONTROL CH.)	X1
	64-121 o	o	X1
Prog Change : True #	o 0-127 XXXXXXXXXXXXXXXXXXXX	o 0-127 0-127	X1
System Exclusive	o / o	o / o X2(SYS.EX.)	X3 / X1
System Common : Song Pos Song Sel Tune	o X2(REMOTE OUT) o X2(REMOTE OUT) x	o X2(REMOTE IN) o X2(REMOTE IN) x	X4
System Real Time : Clock Commands	o X2(CLOCK OUT) o X2(REMOTE OUT)	o X2(CLOCK IN) o X2(REMOTE IN)	
Aux Messages : Local ON/OFF All Notes OFF Active Sense Reset	o x o x	o o 123 o x	X1

Notes - X1 Recognized as record data. Transmitted when (1) playback (2) received during echo switch is on. X2 Enabled or disabled by setup. X3 Sequence data. X4 Reset song position. Transmit only when received. X5 Channel of record data is memorized. (INPUT ASSIGN, OUTPUT ASSIGN)

## **WHAT'S HEXADECIMAL?**

---



---

### **THE HEXADECIMAL SYSTEM**

When dealing with computers, it is often convenient to use the Hexadecimal numbering system (often abbreviated "Hex"). The way of counting that we use everyday is called the decimal system, because it has ten numerals, 0 through 9, and is based on the number ten. The Hexadecimal system uses sixteen numerals. This is a number system based on the number sixteen, with sixteen numerals. Since we only have numerals 0 to 9, we will use letters of the alphabet, like this.

0, 1, 2, 3, 4, 5, 6, 7, 8, 9, A, B, C, D, E, F (Hex "F" = Decimal "15")

Then, when we want to go beyond F, we move one place to the left and start with 0 again.

8, 9, A, B, C, E, D, F, 10, 11, ... 19, 1A, 1B, 1C, 1D, 1E, 1F, 20, 21, ...

(So as not to confuse hexadecimal and decimal numbers, a dollar sign "\$" is often put in front of hex numbers. Eg. \$AD)

---



---

### **HEXADECIMAL / DECIMAL CONVERSION**

Here is an example of how to convert a hex number into decimal.

HEX	3      D	
DECIMAL	$16^1 \times 3 + 16^0 \times 13$	= 61

For your convenience, a Decimal / Hexadecimal / Binary conversion table is included on the next page. (Binary numbers represent the actual electronic on/off pulses inside the computer.)

The next sections "What's MIDI" and "MIDI Format Table" will use Hexadecimal numbers.

BINARY, DECIMAL AND HEXADECIMAL CONVERSION

Binary	Decimal	Hex	Binary	Decimal	Hex	Binary	Decimal	Hex	Binary	Decimal	Hex
00000000	0	0	01000000	64	40	10000000	128	80	11000000	192	C0
00000001	1	1	01000001	65	41	10000001	129	81	11000001	193	C1
00000010	2	2	01000010	66	42	10000010	130	82	11000010	194	C2
00000011	3	3	01000011	67	43	10000011	131	83	11000011	195	C3
00000100	4	4	01000100	68	44	10000100	132	84	11000100	196	C4
00000101	5	5	01000101	69	45	10000101	133	85	11000101	197	C5
00000110	6	6	01000110	70	46	10000110	134	86	11000110	198	C6
00000111	7	7	01000111	71	47	10000111	135	87	11000111	199	C7
00001000	8	8	01001000	72	48	10001000	136	88	11001000	200	C8
00001001	9	9	01001001	73	49	10001001	137	89	11001001	201	C9
00001010	10	A	01001010	74	4A	10001010	138	8A	11001010	202	CA
00001011	11	B	01001011	75	4B	10001011	139	8B	11001011	203	CB
00001100	12	C	01001100	76	4C	10001100	140	8C	11001100	204	CC
00001101	13	D	01001101	77	4D	10001101	141	8D	11001101	205	CD
00001110	14	E	01001110	78	4E	10001110	142	8E	11001110	206	CE
00001111	15	F	01001111	79	4F	10001111	143	8F	11001111	207	CF
00010000	16	10	01010000	80	50	10010000	144	90	11010000	208	C0
00010001	17	11	01010001	81	51	10010001	145	91	11010001	209	D1
00010010	18	12	01010010	82	52	10010010	146	92	11010010	210	D2
00010011	19	13	01010011	83	53	10010011	147	93	11010011	211	D3
00010100	20	14	01010100	84	54	10010100	148	94	11010100	212	D4
00010101	21	15	01010101	85	55	10010101	149	95	11010101	213	D5
00010110	22	16	01010110	86	56	10010110	150	96	11010110	214	D6
00010111	23	17	01010111	87	57	10010111	151	97	11010111	215	D7
00011000	24	18	01011000	88	58	10011000	152	98	11011000	216	D8
00011001	25	19	01011001	89	59	10011001	153	99	11011001	217	D9
00011010	26	1A	01011010	90	5A	10011010	154	9A	11011010	218	DA
00011011	27	1B	01011011	91	5B	10011011	155	9B	11011011	219	DB
00011100	28	1C	01011100	92	5C	10011100	156	9C	11011100	220	DC
00011101	29	1D	01011101	93	5D	10011101	157	9D	11011101	221	CD
00011110	30	1E	01011110	94	5E	10011110	158	9E	11011110	222	DE
00011111	31	1F	01011111	95	5F	10011111	159	9F	11011111	223	DF
00100000	32	20	01100000	96	60	10100000	160	A0	11100000	224	E0
00100001	33	21	01100001	97	61	10100001	161	A1	11100001	225	E1
00100010	34	22	01100010	98	62	10100010	162	A2	11100010	226	E2
00100011	35	23	01100011	99	63	10100011	163	A3	11100011	227	E3
00100100	36	24	01100100	100	64	10100100	164	A4	11100100	228	E4
00100101	37	25	01100101	101	65	10100101	165	A5	11100101	229	E5
00100110	38	26	01100110	102	66	10100110	166	A6	11100110	230	E6
00100111	39	27	01100111	103	67	10100111	167	A7	11100111	231	E7
00101000	40	28	01101000	104	68	10101000	168	A8	11101000	232	E8
00101001	41	29	01101001	105	69	10101001	169	A9	11101001	233	E9
00101010	42	2A	01101010	106	6A	10101010	170	AA	11101010	234	EA
00101011	43	2B	01101011	107	6B	10101011	171	AB	11101011	235	EB
00101100	44	2C	01101100	108	6C	10101100	172	AC	11101100	236	EC
00101101	45	2D	01101101	109	6D	10101101	173	AD	11101101	237	ED
00101110	46	2E	01101110	110	6E	10101110	174	AE	11101110	238	EE
00101111	47	2F	01101111	111	6F	10101111	175	AF	11101111	239	EF
00110000	48	30	01110000	112	70	10110000	176	B0	11110000	240	F0
00110001	49	31	01110001	113	71	10110001	177	B1	11110001	241	F1
00110010	50	32	01110010	114	72	10110010	178	B2	11110010	242	F2
00110011	51	33	01110011	115	73	10110011	179	B3	11110011	243	F3
00110100	52	34	01110100	116	74	10110100	180	B4	11110100	244	F4
00110101	53	35	01110101	117	75	10110101	181	B5	11110101	245	F5
00110110	54	36	01110110	118	76	10110110	182	B6	11110110	246	F6
00110111	55	37	01110111	119	77	10110111	183	B7	11110111	247	F7
00111000	56	38	01111000	120	78	10111000	184	B8	11111000	248	F8
00111001	57	39	01111001	121	79	10111001	185	B9	11111001	249	F9
00111010	58	3A	01111010	122	7A	10111010	186	BA	11111010	250	FA
00111011	59	3B	01111011	123	7B	10111011	187	BB	11111011	251	FB
00111100	60	3C	01111100	124	7C	10111100	188	BC	11111100	252	FC
00111101	61	3D	01111101	125	7D	10111101	189	BD	11111101	253	FD
00111110	62	3E	01111110	126	7E	10111110	190	BE	11111110	254	FE
00111111	63	3F	01111111	127	7F	10111111	191	BF	11111111	255	FF

For an explanation of each type of message, see the MIDI Format Table on the

next page.

# WHAT'S MIDI?

Musical Instrument Digital Interface (MIDI) is a way for keyboards, synthesizers, sequencers, rhythm machines, and computers to communicate with each other. Devices that have a MIDI jack can be connected together to send and receive information. Since most musical instrument manufacturers have agreed on MIDI, you can connect devices of various manufacturers.

Each piece of information is called a MIDI MESSAGE. Each MIDI message is made up of 1 to 3 bytes (numbers); a Status Byte and 0,1 or 2 Data Bytes.

The typical MIDI message is in the following form.

**Sn. xx. yy**

- S = Status (8-E)
- n = Channel number (0-F indicates channel 1-16)
- xx = First data byte (00-7F)
- yy = Second data byte (00-7F)

Let's look at a sample 3-byte MIDI message.

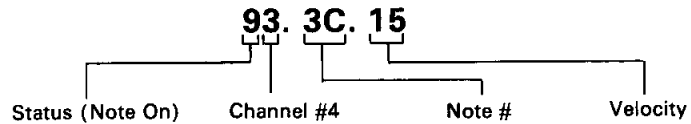

For example, if a DX7 synthesizer receives this message, it does the following.

1. Checks the channel number to see if it is acceptable. If the DX7 has been set to receive that channel, it goes on to the next step. If not, the message is ignored. In the example above, the channel number is 4. (We count 0-F as 1 to 16.)
2. Checks the status. In this case, the status is Note On, so the DX7 knows to expect two more data bytes; note number (what note) and velocity (how hard it was hit).
3. Reads the data bytes and produces the correct note with the correct velocity. (Keep in mind that all this takes a very short time. It takes about 1/1000 of a second to send a MIDI message. To us, it seems as though sound is produced at the same time the key is pressed.)

Some MIDI messages have only two bytes; a status byte and a data byte. For example,

**C3. 05**

is a Program Change message on channel 4, telling the receiving device to switch to program number 6.

MIDI messages with a status byte from F0 to FF have no channel number. They are called System Messages, and are received by all devices regardless of their channel setting.

For an explanation of each type of message, see the MIDI Format Table on the next page.



**MIDI FORMAT TABLE**

	Message	Status Byte	First Data Byte (xx)	Second Data Byte (yy)	
CHANNEL MESSAGE	Note off	8n	Note Number	Velocity	
	Note on	9n	Note Number	Velocity	
	Polyphonic Aftertouch	An	Note Number	Pressure	
	Control Change	Bn	(Control Number) 01 Modulation Wheel 02 Breath Controller 04 Foot Controller 05 Portamento Time 06 Data Entry Slider 07 Main Volume  40 Sustain 41 Portamento 42 Sostenuto 43 Soft  60 Data Increment 61 Data Decrement  7A Local 7B All Note Off 7C Omni Off 7D Omni On 7E Mono On 7F Poly On	Data          7F 7F  00: Off, 7F: On 00 00 00 00-0F (Number of channels) 00	
	Program Change	Cn	Program number		
	Channel Aftertouch	Dn	Pressure		
	Pitch Wheel	En	LSB	MSB	
	SYSTEM MESSAGE	System Exclusive	F0	Mfgr. ID code	(???)
			F1		
		Song Position Pointer	F2	LSB	MSB
Song Select		F3	Song number		
		F4, F5			
Tune Request		F6			
End of Exclusive		F7			
Timing Clock		F8			
		F9			
		Start	FA		
		Continue	FB		
		Stop	FC		
			FD		
	Active Sensing	FE			
System Reset	FF				

**NOTE:**

Explanations of each message are on the following pages. See the MIDI Implementation chart on p.59 for the messages that the QX5 receives and transmits. All numbers are in Hexadecimal. The QX5 displays Decimal numbers, so use the conversion table on p. 53 when making settings.

## MIDI MESSAGES

- 8n Note Off:** The note number indicates which key was released, and velocity indicates how quickly it was released. Very few keyboards have Release Velocity Sensitivity.
- 9n Note On:** The note number indicates which key was pressed, and velocity indicates how hard it was hit. On keyboards which do not have a velocity sensitive keyboard, a medium value of 40 is sent. A Note On message with a velocity of 0 is the same as a Note Off message.
- An Polyphonic Aftertouch:** The note number indicates which key is being pressed, and pressure indicates how hard that key is being pressed. (I.e. each key can send independent aftertouch messages.)
- Bn Control Change:** The control number indicates which controller is being moved, and the data indicates the position of the controller. In this chart, control changes 01-07 are "continuous controllers." (Slider or wheel-type controllers) They carry data in the range of 00-7F. Control changes 40-43 are on/off switch-type controllers. Data 0 is off, data 7F is on.  
Control changes 7A-7F are a special type of control change called Mode Messages, and usually carry a fixed data byte. They tell the receiving tone generator how to behave. The way in which these message are interpreted will depend on the device. (See the MIDI Implementation Chart for your tone generator or synthesizer.)
- Cn Program Change:** This tells the receiving device to switch programs (memories).
- Dn Channel Aftertouch:** Also called "Common Aftertouch", this is found on the DX7. It indicates the strongest pressure on any part of the keyboard, ie, the "common" value.
- En Pitch Wheel :** To provide finer resolution, this data is sent in two bytes, first the Least Significant Byte (LSB) and then the Most Significant Byte (MSB). Yamaha tone generators and synthesizers ignore the LSB.
- F0 System Exclusive:** After F0 must come an identification number which has been assigned to each manufacturer. Yamaha's number is 43. What comes between this message and F7 (End of Exclusive )is completely up to each manufacturer (but each byte must be between 0 and 7F). Yamaha uses System Exclusive messages to transmit voice data, sequence data, rhythm pattern data, bulk memory data of all kinds, and many other useful things. See the System Exclusive format chart for your device.
- F7 End Of Exclusive (EOX):** This marks the end of a System Exclusive message.
- F2,F3,F8,FA,FB,FC,FF:** Song Position Pointer, Song Select, Timing Clock, Start, Stop, Continue, System Reset are all for controlling sequencers and rhythm machines. See the MIDI Implementation Chart for your device.
- FE Active Sensing:** If there are no MIDI messages that have to be sent, one of these is sent just to let the receiving devices know that there is still someone out there. If there have not been any MIDI messages for longer than 300 msec, the receiving device assumes that some error has taken place (eg. a MIDI cable was pulled out by mistake) and will stop all notes.
- F1, F4, F5, F9, FD:** These are unused, and reserved for future expansion.

# QX5 QUICK REFERENCE MANUAL

## RECORD

- \* Recording is always on Track 1.
- \* Track 1 must be on.
- \* Memory Protect must be off.
- \* To record, press

**RECORD** then **START** or **CONTINUE**  
 (From measure 1) (From current measure)

## RECORD MODE

- \* There are three modes.

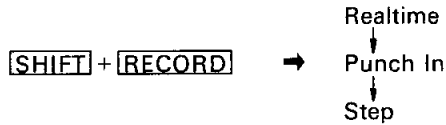

- \* When Auto Locate is on, recording starts from the left Measure Memory.

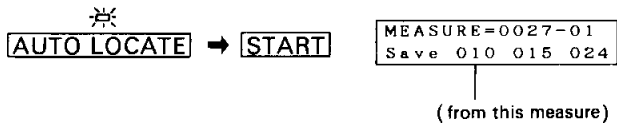

## PUNCH IN RECORD

- \* Set Punch In/Out points to the current measure.

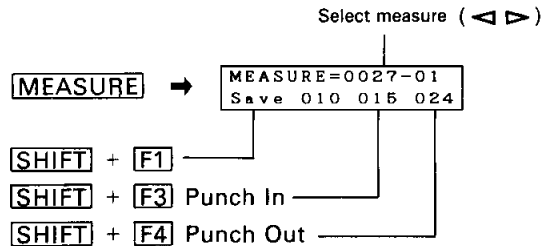

## STEP RECORD

- \* Press **DISPLAY** to show Free Memory or Position.

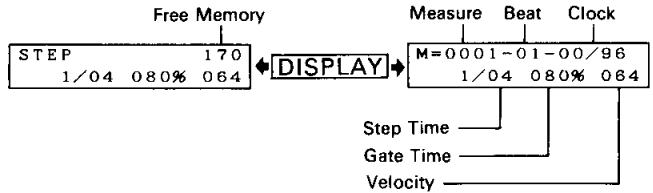

## CURSOR

Select parameter (Position, Step Time, Gate Time, Velocity)



Change parameter

- \* Input notes from a MIDI instrument.

## TEMPO

Erase the previous event.

## MEASURE

Move back one event.

## TRACK

Extend timing of previous note.

## CLOCK

Input rest.

## SHIFT + TEMPO

Delete one measure.

## SHIFT + TRACK

Insert a Measure End mark.

## SHIFT + CLOCK

Rest until end of measure.

## AUTO LOCATE

Protect Step Recorded data.



### **FCC INFORMATION (USA)**

While the following statements are provided to comply with FCC Regulations in the United States, the corrective measures listed below are applicable worldwide.

This series of Yamaha professional music equipment uses frequencies that appear in the radio frequency range and if installed in the immediate proximity of some types of audio or video devices (within three meters), interference may occur. This series of Yamaha combo equipment have been type tested and found to comply with the specifications set for a class 8 computing device in accordance with those specifications listed in subpart J of part 15 of the FCC rules. These rules are designed to provide a reasonable measure of protection against such interference. However, this does not guarantee that interference will not occur. If your professional music equipment should be suspected of causing interference with other electronic devices, verification can be made by turning your combo equipment off and on. If the interference continues when your equipment is off, the equipment is not the source of interference. If your equipment does appear to be the source of the interference, you should try to correct the situation by using one or more of the following measures:

Relocate either the equipment or the electronic device that is being affected by the interference. Utilize power outlets for the professional music equipment and the device being affected that are on different branch (circuit breaker or fuse) circuits, or install AC line filters.

In the case of radio or TV interference, relocate the antenna or, if the antenna lead-in is 300 ohm ribbon lead, change the lead-in to the co-axial type cable.

If these corrective measures do not produce satisfactory results, please contact your authorized Yamaha professional products dealer for suggestions and/or corrective measures.

If you cannot locate a franchised Yamaha professional products dealer in your general area contact the professional products Service Department, Yamaha International, 6600 Orangethorpe Ave., Buena Park, CA 90620, U.S.A.

If for any reason, you should need additional information relating to radio or TV interference, you may find a booklet prepared by the Federal Communications Commission helpful:

"How to Identify and Resolve Radio -- TV Interference Problems". This booklet is available from the U.S. Government Printing Office, Washington D.C. 20402 -- Stock No. 004-000-00345-4.

### **SERVICE**

The QX5 is supported by Yamaha's worldwide network of factory trained and qualified dealer service personnel. In the event of a problem, contact your nearest Yamaha dealer.

