

 **Roland**[®]

D-550

Owner's Manual

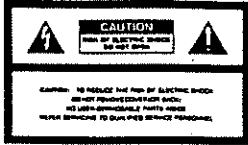

The lightning flash with arrowhead symbol, within an equilateral triangle, is intended to alert the user to the presence of un-insulated "dangerous voltage" within the product's enclosure that may be of sufficient magnitude to constitute a risk of electric shock to persons.

The exclamation point within an equilateral triangle is intended to alert the user to the presence of important operating and maintenance (servicing) instructions in the literature accompanying the product.

INSTRUCTIONS PERTAINING TO A RISK OF FIRE, ELECTRIC SHOCK OR INJURY TO PERSONS.

IMPORTANT SAFETY INSTRUCTIONS

WARNING When using electric products, basic precautions should always be followed, including the following:

1. Read all the instructions before using the product.
2. To reduce the risk of injury, close supervision is necessary when a product is used near children.
3. Do not use this product near water- for example, near a bathtub, washbowl, kitchen sink, in a wet basement, or near a swimming pool, or the like.
4. This product should be used only with a cart or stand that is recommended by the manufacturer.
5. This product, either alone or in combination with an amplifier and headphones or speakers, may be capable of producing sound levels that could cause permanent hearing loss. Do not operate for a long period of time at a high volume level or at level that is uncomfortable. If you experience any hearing loss or ringing in the ears, you should consult an audiologist.
6. The product should be located so that its location or position does not interfere with its proper ventilation.
7. The product should be located away from heat sources such as radiators, heat registers or other products that produce heat.
8. The product should avoid using in where it may be effected by dust.
9. The product should be connected to a power supply only of the type described in the operating instructions or as marked on the product.

10. The power-supply cord of the product should be unplugged from the outlet when left unused for a long period of time.
11. Do not tread on the power-supply cord.
12. Do not pull the cord but hold the plug when unplugging.
13. When setting up with any other instruments, the procedure should be followed in accordance with instruction manual.
14. Care should be taken so that objects do not fall and liquids are not spilled into the enclosure through openings.
15. The product should be serviced by qualified service personnel when:
 - A: The power-supply cord or the plug has been damaged; or
 - B: Objects have fallen, or liquid has been spilled into the product; or
 - C: The product has been exposed to rain; or
 - D: The product does not appear to operate normally or exhibits a marked change in performance; or
 - E: The product has been dropped, or the enclosure damaged.
16. Do not attempt to service the product beyond that described in the user-maintenance instructions. All other servicing should be referred to qualified service personnel.

SAVE THESE INSTRUCTIONS

ADVARSEL !

Lithiumbatteri. Eksplosionsfare.
Udskiftning må kun foretages af en sagkyndig,
og som beskrevet i servicemanual.

WARNING !

Lithiumbatteri. Explosionsrisk.
Får endast bytas av behörig servicetekniker.
Se instruktioner i servicemanualen.

ADVARSEL !

Lithiumbatteri. Fare for eksplosion.
Må bare skiftes av kvalifisert tekniker som
beskrevet i servicemanualen.

VAROITUS !

Lithiumparisto. Räjähdyksvaara.
Pariston saa vaihtaa ainoastaan
aian ammottimies.

WARNING

THIS APPARATUS MUST BE EARTH GROUNDED.

The three conductors of the mains lead attached to this apparatus are identified with color as shown in the table below, together with the matching terminal on the UK type power plug. When connecting the mains lead to a plug, be sure to connect each conductor to the correct terminal, as indicated. "This instruction applies to the product for United Kingdom."

MAINS LEADS		PLUG
Conductor	Color	Mark on the matching terminal
Live	Brown	Red or letter L
Neutral	Blue	Black or letter N
Grounding	Green- Yellow	Green, Green-Yellow, letter E or symbol

Bescheinigung des Herstellers / Importeurs

Hiermit wird bescheinigt, daß der/die/das

ROLAND LINEAR SYNTHESIZER O-550

(Gerät Typ Bescheinigung)

in Übereinstimmung mit den Bestimmungen der

Amtsbl. Vfg. 1046 1984

(Anschlusserklärung)

Funkentstört 1st

Der Deutschen Bundespost wurde das Inverkehrbringen dieses Gerätes angezeigt und die Berechtigung zur Überprüfung der Serie auf Einhaltung der Bestimmungen eingeräumt.

Roland Corporation Osaka, Japan

(Name des Herstellers / Importeurs)

RADIO AND TELEVISION INTERFERENCE

Warning - This equipment has been tested to comply with the limits for a Class B computing device, pursuant to Subpart J, of Part 15, of FCC rules. Operation with non-certified or non-UL-listed sound motors is likely to result in interference to radio and TV reception.

The equipment described in this manual operates and uses radio frequency energy. It is not shielded and uses products that are, in other respects, used per instructions, it may cause interference with other radio and television reception.

This equipment has been tested and found to comply with the limits for a Class B computing device in accordance with the requirements of Subpart J, of Part 15, of FCC Rules. These limits are designed to provide reasonable protection against such a interference in a residential installation.

However, there is no guarantee that the interference will not occur in a particular installation. If you experience such radio interference to radio or television reception, which can be determined by turning the equipment off and on, you are encouraged to try to correct the interference by the following measures:

- Disconnect other devices and their interconnecting cables and so a letter if the interference stops or is reduced by either the above device or the TV set.

- These devices usually require Radio Designated impedance 15 ohms. For Radio devices you can locate the ground shielded cable from your device. For non-Radio devices, return the manufacturer or dealer for assistance.

- In case equipment does radio interference to radio or television reception you can try to correct the interference by using any or more of the following measures:

- Turn the TV or radio antenna until the interference stops.

- Move the equipment to the side of the same of the TV or radio.

- Move the equipment and its cables away from the TV or radio.

- Plug the equipment into a multi-line or a different device than the TV or radio. This is useful if you can find the equipment and the radio or television set and are connected by different device (cables or lines).

- Connect equipment to a different impedance ground with shielded cable lead of television the ground and so.

- If interference still exists, contact your dealer or an independent local television technician for additional suggestions. You may find useful the following booklet prepared by the Federal Communications Commission:

How to Identify and Report Radio Frequency Interference or Disturbance

This booklet is available from the U.S. Government Printing Office, Washington, D.C. 20540. Price: \$0.50 (1984).

Please read the separate volume "MIDI", before reading this owner's manual.

Copyright © 1987 by ROLAND CORPORATION

All rights reserved. No part of this publication may be reproduced in any form without the written permission of ROLAND CORPORATION.

CONTENTS

Panel Description	3
An Outline of the D-550	6
1. The Basic Concept of the D-550	6
2. The Four Modes of the D-550	8
Connection	9
Play Mode	11
1. Power-up	12
2. MIDI Channel Selection	13
3. Patch Selection	15
4. Tuning	19
5. Chase Play	20
6. Changing the Overall Level of the Reverb Effect	21
Edit Mode	23
1 Basic Editing Procedures	24
1. Basic Procedures	24
2. Editing Functions	27
a. Compare	27
b. Undo	27
c. Programming Edit Displays	28
d. Tone & Partial Balance	29
3. Naming	31
2 MIDI Functions	33
1. Editing MIDI Functions	33
2. Description of the MIDI Functions	34
a. MIDI-1	34
b. MIDI-2	35
c. MIDI-3	35
d. MIDI-4	36
3 Patch Factors	37
1. Editing Patch Factors	37
2. Description of the Patch Factors	39
a. Key Mode (Split Point)	39
b. Volume Balance of the Tones	42
c. Patch Control	43
d. Portamento	44
e. Output Mode	45
f. Tone Tuning	46
g. Chase Play	47
h. MIDI	48
4 An Outline of the Tone Parameters	49
1. The Basic Concept of a Tone	49
2. Structure of the Tone Parameters	51
a. WG	53
b. TVF	53
c. TVA	53
d. ENV	54
e. LFO	54
5 Tone Editing	55
1. Changing Parameter Displays	55
2. Editing Functions	57
a. Copy	57
b. Partial Mute	60
c. Partial Balance	61
3. Initializing a Partial	62
6 Tone Parameters	63
1. Common Parameters	63
a. Structures	63
b. P-ENV	64
c. Pitch Modulation	67
d. LFO	68
e. Equalizer	69
f. Chorus	71
2. Partial Parameters	72
a. WG Pitch	72
b. WG Modulation	74
c. WG Waveform	75
d. WG Pulse Width	77
e. TVF	79
f. TVF ENV	82
g. TVF Modulation	85
h. TVA	86
i. TVA ENV	88
j. TVA Modulation	91
7 Writing (Storing Patches in Memory)	92
a. Writing into the Internal Memory	93
b. Writing onto a Memory Card	97
c. Writing Procedure using the PG-1000	99
Data Transfer	101
1. Patch Transfer	103
a. Patch Transfer to a Memory Card	103
b. Patch Transfer to the Internal Memory	105
2. Data Transfer via MIDI	107
3. Copying a Reverb Type	110
a. Copying from a Memory Card to the D-550	110
b. Copying from the D-550 to a Memory Card	111
Appendix Tables	112
1. MIDI Function Table	112
2. Patch Factor Table	113
3. Tone Parameter Table	114
a. Common Parameters	114
b. Partial Parameters	115
4. Error Message Table	116
5. Sample Notes	117
Specifications	121

PANEL DESCRIPTION

Front Panel

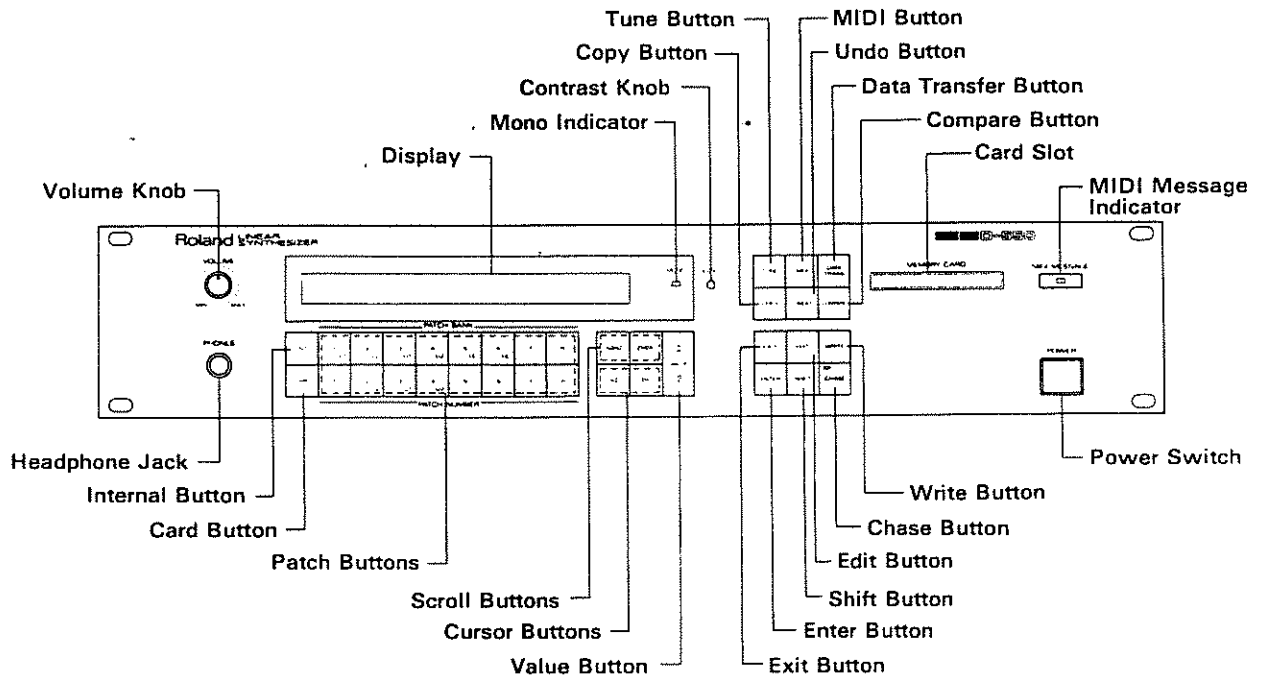

Rear Panel

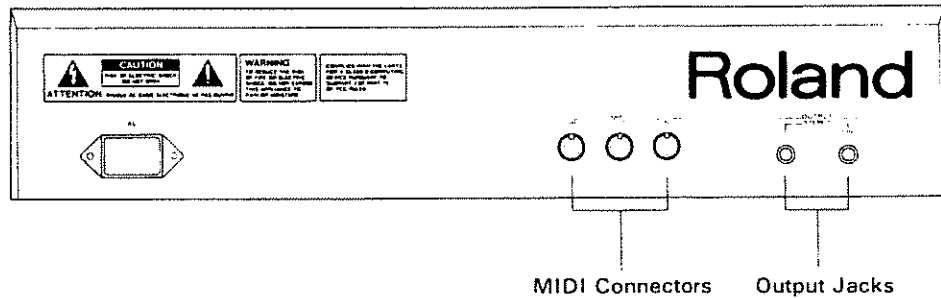

FEATURES

- *The D-550 can store up to 64 different patch programs.
- *The D-550's LA sound source is capable of warm analog-type sounds as well as sharp attack (digital) sounds.
- *Digital equalization, chorus and reverb effects are also built in.
- *The data stored in the D-550's memory can be saved onto a memory card.
- *The optional programmer (PG-1000) can be used for quicker and easier sound synthesis.

IMPORTANT NOTES

- The appropriate power supply for this unit is shown on its name plate. Make sure that the line voltage in your country meets the requirement.
- Do not use the same socket used for any noise generating unit such as a motor or variable lighting system.
- Before connecting the power cable to the socket, turn the unit off.
- Connect the power cable to this unit first, then the power plug to the socket.
- When disconnecting the power cable from the socket, do not pull the cord but hold the plug.
- Handle the cables gently.
- When the unit is not to be used for a long period of time, disconnect the power cable from the socket.
- It is normal for this unit to become hot while being operated.
- When making or breaking connection, turn all the units off.
- When you cannot turn off the unit and the amplifier before setting them up for some reason, plug in the unit first, then the amplifier. And take the reverse procedure for disconnecting them.
- This unit might not work properly if turned on immediately after being turned off. If this happens, simply turn it off and turn it on again after waiting a few seconds.
- Operating this device near a neon, fluorescent lamp, TV or CRT may cause noise interference. If so, change the angle or the position of the device.
- Operating this unit near a TV or radio may cause various troubles on the TV or radio. If so, move the unit away from the TV or radio.
- Avoid using this device in extreme heat, humidity or where it may be affected by dust or vibration.
- Use a mild detergent and soft cloth for cleaning. Do not use solvents such as thinner.
- Do not place or drop a heavy object on the power cable or connection cord.
- This unit features a memory back-up system that retains the data even when switched off. The battery that supports the back-up circuits should be replaced every five years. Call Roland for battery replacement. (The first replacement may be required before five years, depending on how much time has passed before you purchased the device.) When the battery is low, the display responds with "Check Internal Battery" at power-up, and the data in the memory may be lost.
- To avoid accidental erasure or loss of data, make a data memo, or save the data onto a Memory Card. If it happens to be erased while the device is being repaired, there is no way to restore the data.

AN OUTLINE OF THE D-550

1. The Basic Concept of the D-550

The ROLAND D-550 is very different from any other synthesizer, past or present, and as such heralds the dawn of a new era in synthesis. In the past, synthesizers have progressed through several very different stages. Firstly, there were ANALOG synthesizers, which relied on a variety of components, such as, VCO's, VCF's, and VCA's. These analog building blocks were relatively easy to understand and program, and they could produce sounds of remarkable warmth and character. However, when it came to accurately simulating acoustic sounds, the process could easily become too involved.

On the other hand, the next breed of synthesizers, known as DIGITAL synthesizers, could easily simulate acoustic sounds, yet they were far more difficult to program. Furthermore, the digital technology behind these instruments seemed to imply that a different type of sound should occur. In general, just as an analog synthesizer would be described as "warm" in character, the digital counterpart was very often "thin". Essentially, the two types complemented each other, one being easy to program, the other capable of accurate simulation.

The ROLAND D-550 has now changed all that. Thanks to a new custom designed Integrated Circuit known as the 'LA CHIP'. Here, LA stands for Linear Arithmetic synthesis which is the heart of the new technology. LA synthesis involves a great many technological advances resulting not only in a superior sound quality but also an improved ease of programming. In this way, Roland has succeeded in maintaining a high degree of familiarity to the user despite the technical wizardry involved.

To explain the D-550 in a very simple manner, we must begin by saying that it is the next step in DIGITAL synthesizers. This means that the sound is entirely computer generated. In fact, the D-550 has four distinct sections :

1. A Digital Synthesizer
 2. A Digital Equalizer
 3. A Digital Chorus section
- and 4. A Digital Reverberation section.

Moreover, these four sections occur entirely within the DIGITAL DOMAIN, resulting in a sound quality far beyond that of four similar units combined. Consequently, the musician can take advantage of a complete instrument, one that requires no additional effects or processing.

However, the true power of LA Synthesis lies within the Digital Synthesizer section of the D-50. Remember, first of all, that this is a totally digital instrument, even though the sound would seem to suggest far more. Through LA synthesis, the D-550 appears to have four powerful synthesizers built in. Each of these hypothetical synthesizers could behave like a conventional analog synthesizer, or a PCM sampled synthesizer. Consequently, they are referred to as PARTIALS, since they are far more than just a pure synthesizer. These PartialS are combined in pairs to form a TONE. A Tone could either be a mix of the two PartialS, or they could take advantage of the LA version of cross modulation. In this way, some of today's more popular digital sounds are remarkably easy to achieve.

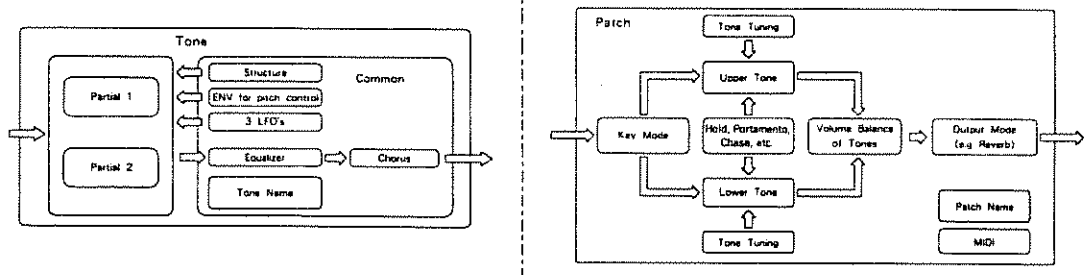

During live performance, you can easily select a PATCH, which is the combination of two Tones, together with programmed E.Q., chorus and reverb. These other parameters are referred to as COMMON parameters since they are common to both Tones. Throughout the process of programming the D-550, the operation remains simple and logical. Even so, to further improve the ease with which sound can be created, an optional programmer, the PG-1000 is available, which graphically displays all the parameters of the D-550, making it exceptionally simple to operate.

However, it is the performance characteristics such as after-touch, and the control of every aspect of the sound that makes the D-550 a totally new instrument. These things and a sound that can only be described as unique, the LA sound.

Partial Block Diagram

Partial (Synthesizer Sound Generator)

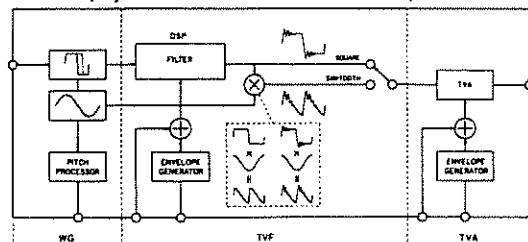

Partial (PCM Sound Generator)

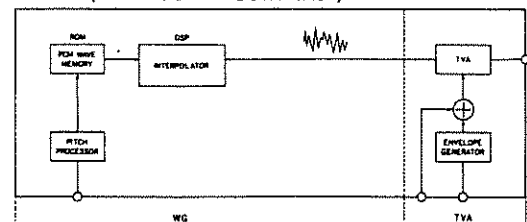

2. The Four Modes of the D-550

There are the following four operation modes in the D-550

[Play Mode]

This mode allows you to call any patch you like and play it.

[Edit Mode]

This mode allows you to edit Patch Factors, Tone Parameters, MIDI Functions, etc.

The edited Patch Factors and Tone parameters are erased when the unit is turned off or a different patch is called. If you wish to retain the edited data, follow the appropriate writing procedure.

[Write Mode]

In the Write mode, the edited data can be written into the internal memory or onto a memory card.

[Data Transfer Mode]

In the Data Transfer mode, the entire data can be transferred between the D-550 and a memory card, or between two D-550s.

CONNECTION

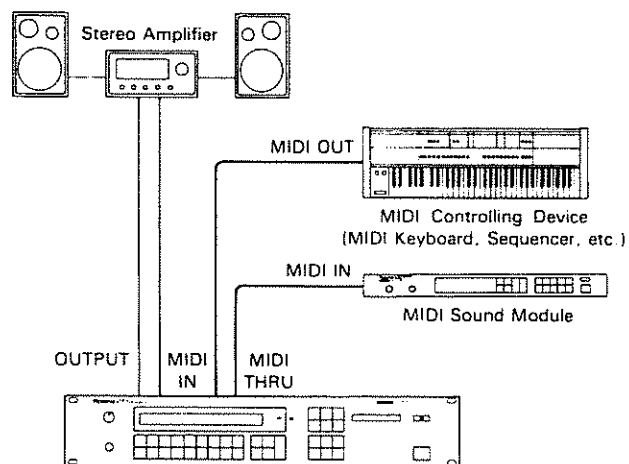

[Advanced Example]

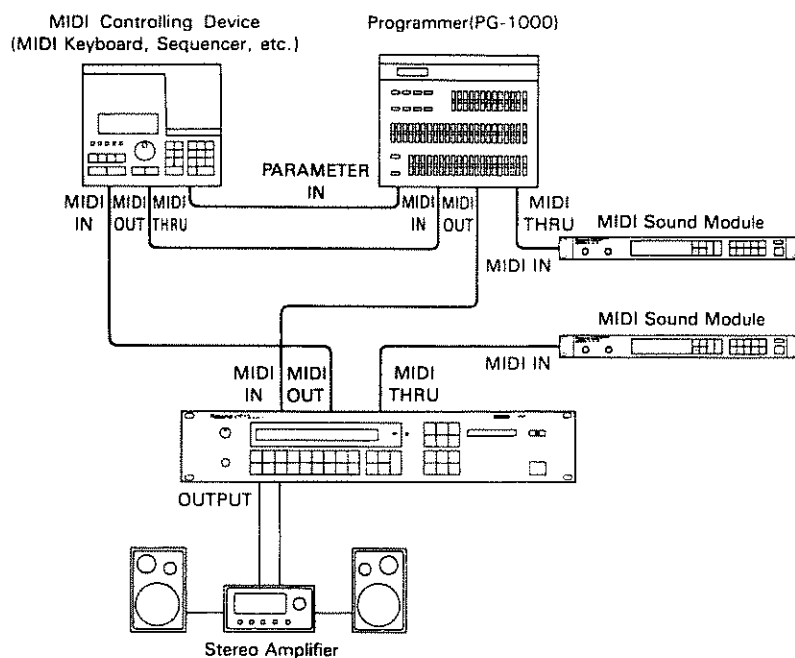

*The MIDI messages fed into the MIDI IN connector are sent through the MIDI THRU. Using MIDI THRU connectors, it is possible to control more than one MIDI sound module from one controlling unit. Theoretically speaking, one unit can control an infinite number of sound modules, but in practice, connecting more than a few sound modules will cause malfunctions. To connect more than three devices, use the optional MIDI Output Selector (MPU-105).

*The MIDI messages fed into the MIDI IN are not sent through the MIDI OUT.

PLAY MODE

1. Power-Up	12
2. MIDI Channel Selection	13
3. Patch Selection	15
4. Tuning	19
5. Chase Play	20
6. Changing the Overall Level of the Reverb Effect	21

PLAY MODE

The Roland D-550 is a MIDI Sound Module that is played by MIDI messages sent from an external control unit.

1. Power-up

First of all, make sure that the D-550 is correctly and securely connected to the other devices.

Step 1 Turn the D-550 on.

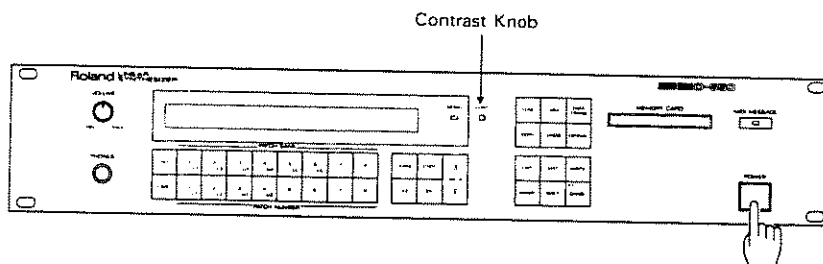

The Display responds as shown below.

```
***** Linear Synthesizer D-550 *****  
                      Roland Corporation
```



```
I-11 ***** U: *****  
WHOLE SP C4 Bal 50 L: *****
```

Play Mode Display

*The contrast of the Display can be adjusted with the Contrast Knob.

Step 2 Switch the control unit connected to the D-550 on.

2. MIDI Channel Selection

The MIDI channels of the connected devices should be set to the same number. If the receive channel of the D-550 is not set correctly, MIDI messages sent from an external controlling unit cannot be received properly, therefore, you cannot obtain proper results.

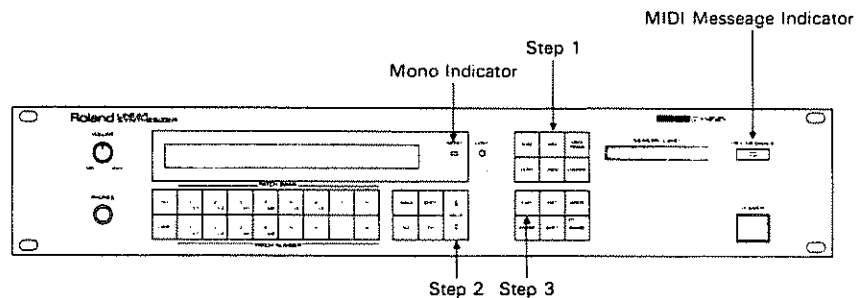

Step 1 Push the MIDI Button.

MIDI-1	MIDICH	Control	Se#CH	Omni
	01	B.CH	01	OFF

Flash

Step 2 Using the Value Button, set the MIDI channel (=the basic channel) of the D-550 to the same number as that of the controlling unit.

Pushing the Δ side increases the number, and the ∇ side decreases it.

*When the D-550 receives MIDI messages from an external controlling unit, the MIDI Message Indicator on the front panel will light up.

Step 3 Push the Exit Button to return to the Play mode.

*The MIDI Channel you have set is retained in memory even after the unit is turned off.

PLAY MODE

[Poly Mode/Mono Mode]

MIDI Poly mode allows the control of more than one Key message on one channel at a time, and **MIDI Mono** mode allows only one MIDI message on one channel. The D-550 can use either mode.

When set to **Poly mode**, the D-550 is 16 or 8 voice polyphonic (depending on the patch used). So, the Poly mode can be used when the D-550 is controlled by a keyboard or sequencer.

When set to **Mono mode**, the D-550 is 8 voice polyphonic using 8 MIDI channels. The Mono mode, therefore, is ideal for a MIDI Guitar System that has Mono mode, and therefore transmits the messages (Note and Bender messages) of each string separately on a different channel. In the other words, Mono mode makes it possible to reproduce guitar sounds without spoiling the natural characteristics of the instrument.

Select Poly or Mono mode depending on the type of Mode messages sent from the external controlling unit. When Mono Mode messages are received by the D-550, the Mono Indicator on the front panel will light up. This indicates that messages can now be received on a Channel Group (=eight consecutive MIDI channels, the basic channel being the lowest number).

[e.g.] When using a MIDI Guitar System that features MIDI Mono mode.

1st string	→ (n) ch	n=Basic Channel
2nd string	→ (n+1) ch	
3rd string	→ (n+2) ch	
4th string	→ (n+3) ch	
5th string	→ (n+4) ch	
6th string	→ (n+5) ch	

*Messages sent on any channel higher than 16 will be ignored.

*When you switch on the Guitar-MIDI Converter (GM-70), or select a different patch on it, Mode messages are transmitted on the set MIDI channel.

*The Mono mode of the D-550 allows it to receive only the Note and Bender messages for each channel, therefore it is not possible to set a different sound for each note separately.

3. Patch Selection

A Patch is represented by a Bank (1 to 8) and a Number (1 to 8). The D-550 can retain up to 64 different Patches, and a Memory Card can also store up to 64 Patches. So, you can use any of the 128 Patches.

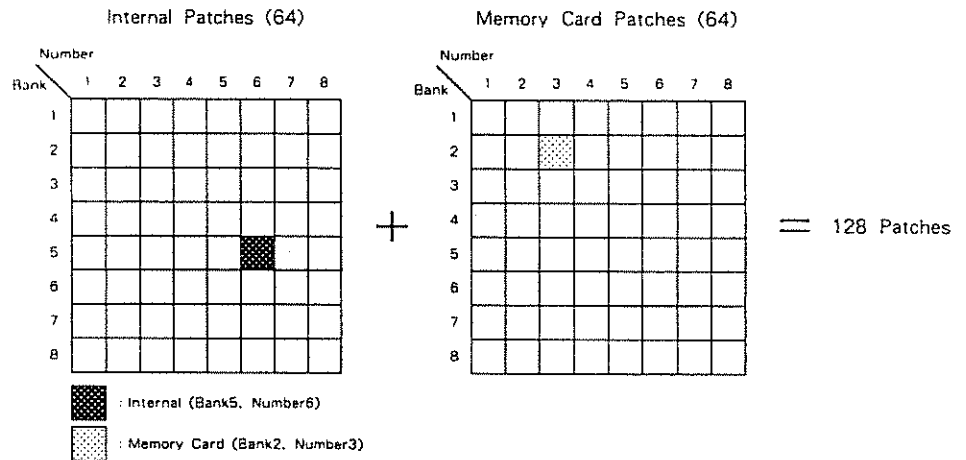

To change Patches on the D-550, push the relevant Bank and Number Buttons.

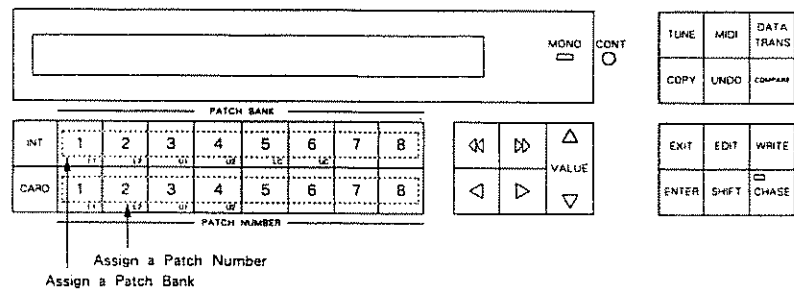

Patch selection is also possible via Program Change messages sent from an external controlling unit.

The following table shows how each Patch number corresponds to a Program Change number.

Group	Bank	Number							
		1	2	3	4	5	6	7	8
Internal	1	1	2	3	4	5	6	7	8
	2	9	10	11	12	13	14	15	16
	3	17	18	19	20	21	22	23	24
	4	25	26	27	28	29	30	31	32
	5	33	34	35	36	37	38	39	40
	6	41	42	43	44	45	46	47	48
	7	49	50	51	52	53	54	55	56
	8	57	58	59	60	61	62	63	64
Card	1	65	66	67	68	69	70	71	72
	2	73	74	75	76	77	78	79	80
	3	81	82	83	84	85	86	87	88
	4	89	90	91	92	93	94	95	96
	5	97	98	99	100	101	102	103	104
	6	105	106	107	108	109	110	111	112
	7	113	114	115	116	117	118	119	120
	8	121	122	123	124	125	126	127	128

*MIDI Program Change Messages 0-127 are transmitted.

The Display shows the setting of the selected Patch.

- When a Patch from the internal memory is selected, "I" is shown.
- When a Patch from the Memory Card is selected, "C" is shown.

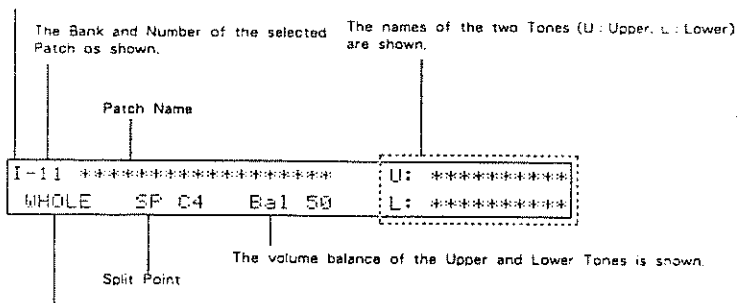

[Key Mode]
Key Mode and MONO/POLY Mode determine how the Upper and Lower Tones are played as shown below.

Key Mode	Poly Mode	Mono Mode
WHOLE	The Upper Tone is played on the entire key range in 16 voice polyphony.	The Upper Tone is played by 8 sets of monophonic modules.
DUAL	Both Upper and Lower Tones are played by each key in 8 voice polyphony.	The mixed sound of the Upper and Lower Tones is played by 8 sets of monophonic modules.
SPLIT	This mode divides the key range into upper and lower sections where two different Tones can be used. Each section is 8 polyphonic. (Middle C=C4) When a Note number higher than Split Point is received, the Upper Tone is played, and any lower Note number plays the Lower Tone.	This mode divides the key range into upper and lower sections where two different Tones can be used. Each section has 8 sets of monophonic modules. When a Note number higher than Split Point is received, the Upper Tone is played, and any lower Note number plays the Lower Tone.

*Some other special Key Modes are also provided.

[Memory Card]

When you wish to use a Memory Card, insert the card into the Card Slot in the correct direction, as shown in the picture below.

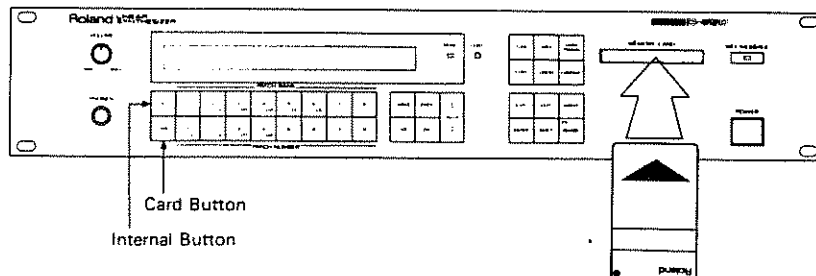

To call a Patch from the Memory Card, push the Card Button, then push the relevant Bank and Number Buttons. To return to the internal memory mode, push the Internal Button.

*If the Memory Card is not connected securely, or not connected at all, the Display shows the following error message for a few seconds.

Card Not Ready

There are two types of Memory Cards :

● ROM

ROM stands for "Read Only Memory". Data stored on this type of Memory Card cannot be rewritten, and is therefore stored securely. The Memory Card supplied with the D-550 and the optional sound library are ROMs.

● RAM (M-256D)

RAM stands for "Random Access Memory", and implies that data can be both read and written to this card. Data stored on this type of Memory Card can be modified as many times as you like. The data on it is supported by a battery (backup). The M-256D, an optional memory card, is a RAM card. Use this type to store your own patches.

*The supplied Memory Card contains exactly the same Patches as those pre-programmed in the internal memory of the D-550. This allows you to restore the preprogrammed Patches even after erasing them.

*Use only specified Memory Cards.

PLAY MODE

If you use a Memory Card that contains data for equipment other than the D-550 or D-50, the following error message will be shown in the Display for a few seconds.

Illegal Card

4. Tuning

The D-550's Master Tuning function allows you to tune the D-550 to another musical instrument.

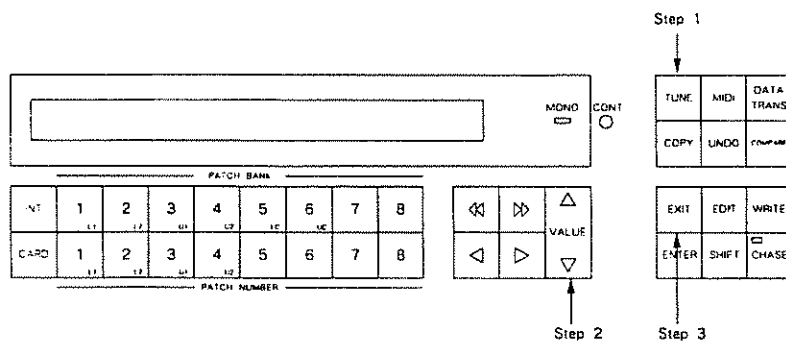

Step 1 Push the Tune Button.

Master Tune	Protect	Reverb
442Hz	ON	3

Flash

Step 2 Adjust the pitch of the D-550 using the Value Button.

Pressing the Δ side of the Value Button raises the pitch, and the ∇ side lowers it. Pressing one side while holding the other side will quicken the change.

The number shown in the Display represents the frequency of standard pitch (A4). The number changes in 1Hz steps, but the pitch actually changes continuously.

Step 3 Push the Exit Button to return to the Play mode.

*This Master Tune value is retained in memory even after the unit is turned off.

5. Chase Play

The Chase Play function makes it possible to output the Lower Tone slightly later than the Upper Tone. This function, however, is only available in the Dual or Whole mode.

Push the Chase Button to turn to the Chase Play mode, and the indicator will light up.

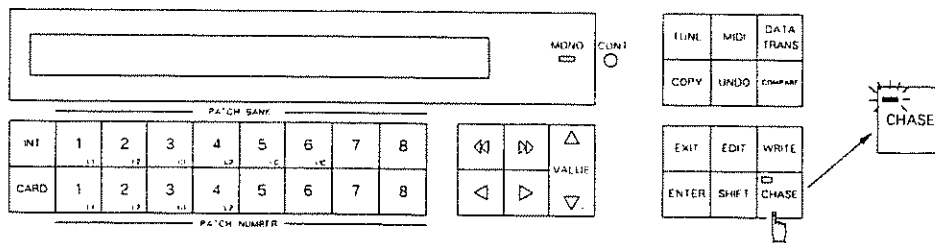

Pushing the Chase Button again will exit the Chase Play mode.

*When the selected Key Mode is other than Whole or Dual, the following error message is shown in the Display and the Chase Play is not turned on.

Set key mode WHOLE or DUAL

*The ON/OFF value of the Chase Play function can be written individually for each Patch. To write Chase Play ON, call a Patch, turn the Chase Play function on, then write the patch into memory. (See page 92.)

*The ON/OFF of the Chase Play function can be controlled by Control Change messages transmitted from an external controlling unit. (See page 36 "MIDI-4")

6. Changing the Overall Level of the Reverb Effect

The D-550 allows you to change the sensitivity of the reverb effect (see page 46) set in each Patch. In this way the reverb set in all the patches can be changed at the same time to suit the playing environment. You can choose one of the four modes depending on the acoustic environment. For instance, when the room is live, you may wish to weaken the reverb effect. You may even wish to cut the reverb entirely when using an external reverb effect.

*What is controlled here is the sensitivity of the reverb effects, therefore, the actual reverb effect set in each Patch is not affected.

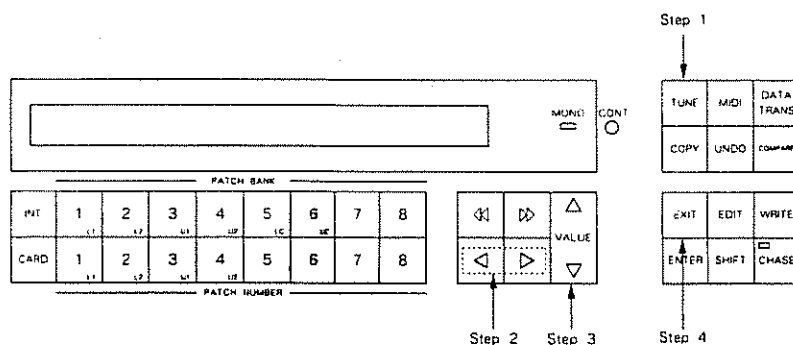

Step 1 Push the Tune Button.



Step 2 Using the Cursor Buttons, move the cursor to the position of the reverb value.

Step 3 Using the Value Button, select one of the four values.

- *OFF (the entire reverb effect is cut)
- *1 (slight reverb effect)
- *2 (reverb effect cut to half)
- *3 (full reverb effect is obtained)

*Normally, when editing, set to "3".

Step 4 Push the Exit Button to return to the Play Mode.

*The value you set here will be retained in memory even after the unit is turned off.

EDIT MODE

<ul style="list-style-type: none"> ① Basic Editing Procedures 24 <ul style="list-style-type: none"> 1. Basic Procedures 24 2. Editing Functions 27 <ul style="list-style-type: none"> a. Compare 27 b. Undo 27 c. Edit Displays 28 d. Tone & Partial Balance 29 3. Naming 31 ② MIDI Functions 33 <ul style="list-style-type: none"> 1. Editing MIDI Functions 33 2. Description of the MIDI Functions 34 <ul style="list-style-type: none"> a. MIDI-1 34 b. MIDI-2 35 c. MIDI-3 35 d. MIDI-4 36 ③ Patch Factors 37 <ul style="list-style-type: none"> 1. Editing Patch Factors 37 2. Description of the Patch Factors 39 <ul style="list-style-type: none"> a. Key Mode (Split Point) 39 b. Volume Balance of the Tones 42 c. Patch Control 43 d. Portamento 44 e. Output Mode 45 f. Tone Tuning 46 g. Chase Play 47 h. MIDI 48 ④ An Outline of the Tone Parameters 49 <ul style="list-style-type: none"> 1. The Basic Concept of a Tone 49 2. Structure of the Tone Parameters 51 <ul style="list-style-type: none"> a. WG 53 b. TVF 53 c. TVA 53 d. ENV 54 e. LFO 54 	<ul style="list-style-type: none"> ⑤ Tone Editing 55 <ul style="list-style-type: none"> 1. Changing Parameter Displays 55 2. Editing Functions 57 <ul style="list-style-type: none"> a. Copy 57 b. Partial Mute 60 c. Partial Balance 61 3. Initializing a Partial 62 ⑥ Tone Parameters 63 <ul style="list-style-type: none"> 1. Common Parameters 63 <ul style="list-style-type: none"> a. Structures 63 b. P-ENV 64 c. Pitch Modulation 67 d. LFO 68 e. Equalizer 69 f. Chorus 71 2. Partial Parameters 72 <ul style="list-style-type: none"> a. WG Pitch 72 b. WG Modulation 74 c. WG Waveform 75 d. WG Pulse Width 77 e. TVF 79 f. TVF ENV 82 g. TVF Modulation 85 h. TVA 86 i. TVA ENV 88 j. TVA Modulation 91 ⑦ Writing (Storing Patches in Memory) 92 <ul style="list-style-type: none"> a. Writing into the Internal Memory 93 b. Writing onto a Memory Card 97 c. Writing Procedure using the PG-1000 99
--	---

1 BASIC EDITING PROCEDURE

Patch Factors, Tone Parameters and MIDI Functions can be edited.

1. Basic Procedure

A number of elements are shown in a Menu Display at the same time. There are several Menu Displays. Each element shown in a Menu Display contains several more elements, and these elements are shown in a further display. In other words, there are different ranks of Displays. To edit an element, call the Display that contains the element, then assign a new value to that element.

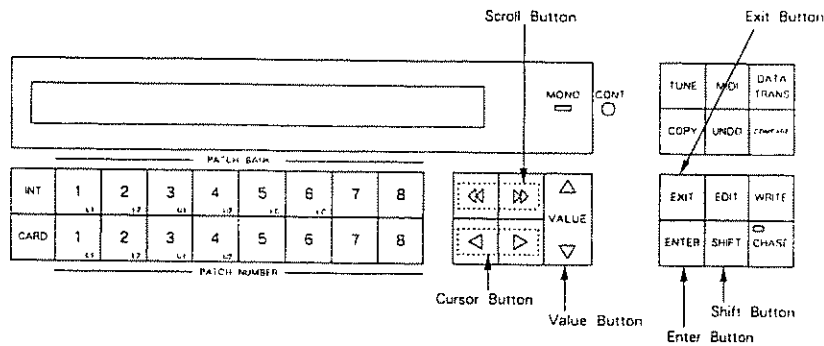

The following explains how each button works for editing.

Example editing for Patch Factors and Tone Parameters is shown on the following page. Study it together with how each button functions.

- select an item to be edited from a Menu Display, move the cursor (flashing) to the relevant position, then push the Enter Button.
- select an element to be edited from a Display, move the cursor to the position, and change the value with the Value Button.
- to scroll a Menu Display, use the Scroll Button. (In the "Editing Example", each block is represented as @ - ①.)
- to go to an upper rank of the Display, use the Exit Button. To go to the Play Mode Display immediately, push the Exit Button while holding the Shift Button down.

[Editing Example]

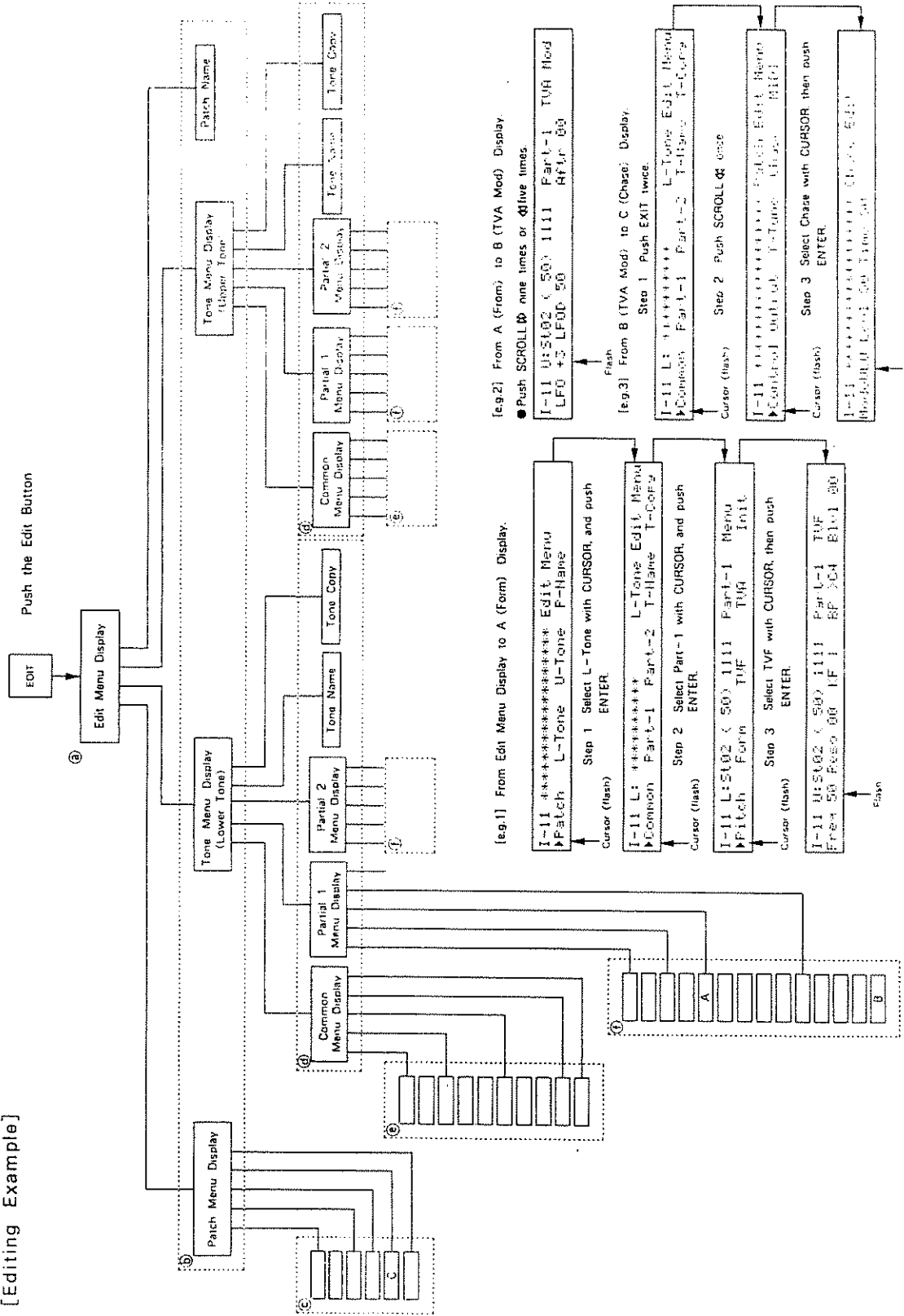

[e.g.1] From Edit Menu Display to A (Form) Display.

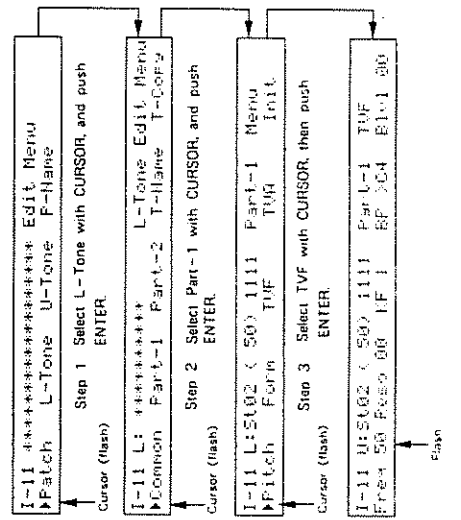

[e.g.2] From A (From) to B (TVA Mod) Display.

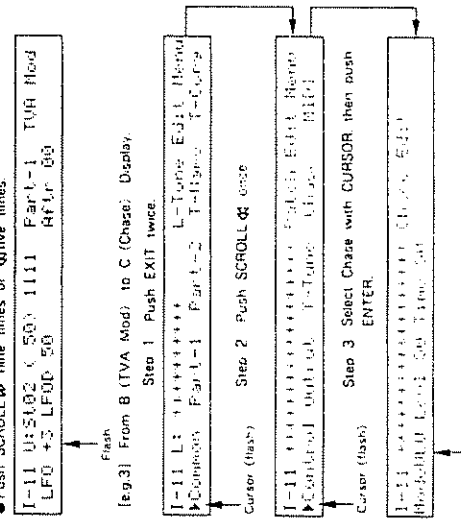

BASIC EDITING PROCEDURE

- *When editing a Tone Parameter, some other buttons can also be used for quickly changing the Displays. (See page 55 "Changing Parameter Displays".)
- *The edited Tone Parameter or Patch Factor data is erased when the unit is turned off or a new Patch is selected. To retain the data, follow the writing procedure explained on page 92.

2. Editing Functions

The D-550 features several useful editing functions. The following explains those which may be most often used, but there are some more functions for editing Tone Parameters. (See page 55 "Editing a Tone".)

a. Compare

While editing a Patch Factor or Tone Parameter, you may wish to hear the original sound before it was edited. The D-550's Compare function allows you to call the original Patch without crasing the edited sound.

Step 1 Push the Compare Button.

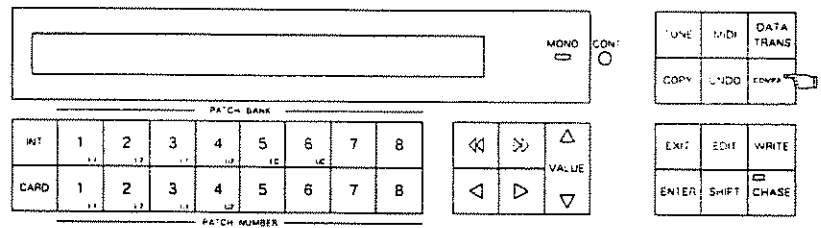

The Display responds as shown below, and the original sound may be heard by playing the controlling unit.

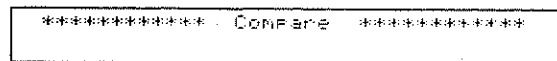

Step 2 Push the Compare Button again, and the previous Display returns and the edited sound will come back.

*When the Display shows the Compare mode indication, editing cannot be achieved.

b. Undo

The Undo function returns the current value of the element to the previous value, that is, the value just before it was changed to the current value.

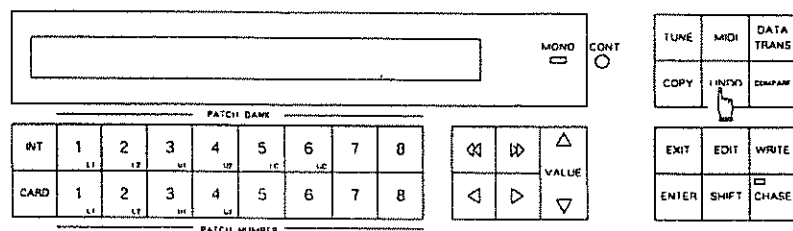

Simply push the Undo button after changing the value.

c. Programming Edit Displays

Up to eight Edit Displays can be programmed and written into memory. By programming Edit Displays which are frequently used, quicker editing can be achieved.

[How to Program Edit Displays]

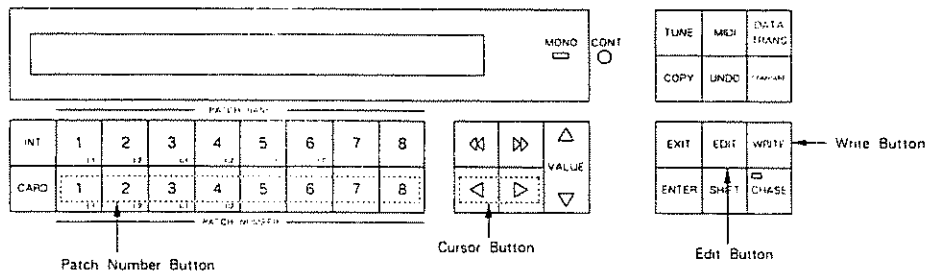

- Step 1 Call the Display you wish to write into memory.
- Step 2 The positions of the cursor in the Display will also be written. Move the cursor if necessary.
- Step 3 The Display you have called can be written into any location of the Number Buttons 1 to 8. While holding the Edit Button down, push the Write Button, then without releasing them, push the relevant Number Button.

When the Display is written, the Display responds as shown below for a few seconds.

*The Display you have written will be retained even after the unit is turned off.

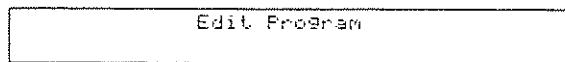

[How to call the Edit Displays, 1 to 8]

While holding the Edit Button down, push the Number Button that corresponds to the location of the Display you want.

d. Tone & Partial Balance

The volume balance of the Upper and Lower Tones in a Patch and /or the balance of the Partials in each Tone can be edited in either the Play or Edit mode. By editing the volume balance, the nuance of the sound will change drastically.

*The volume balance you have set is erased when the unit is turned off, or a different Patch is selected. If you wish to keep it in memory, follow the writing procedure explained on page 92.

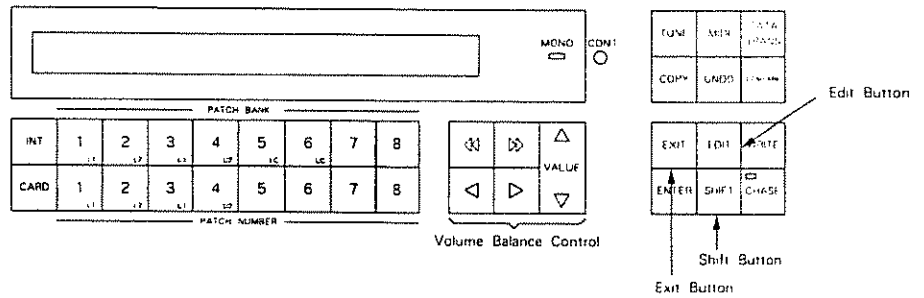

Step 1 While holding the **Shift** Button down, push the **Edit** Button.

The level indicators in the Display show how the volume balances are set.

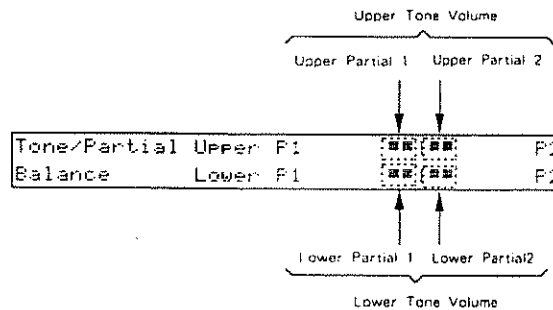

Step 2

By using the button shown below, each of the volume balances can be edited.

{Upper Partial Balance

Pushing \triangleright increases Partial 2 volume, decreasing Partial 1.

Pushing \triangleleft increases Partial 1 Volume, decreasing Partial 2

{Lower Partial Balance.

Pushing \triangleright increases Partial 2 volume, decreasing Partial 1.

Pushing \triangleleft increases Partial 1 Volume, decreasing Partial 2

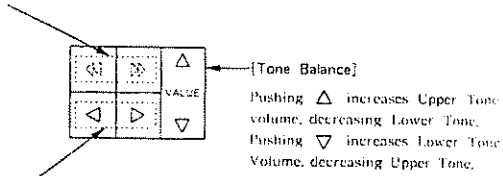

The level indicators in the Display change fairly roughly, but the actual volume changes are almost continuous.

Step 3

Push the Exit Button to return to the previous Display.

3. Naming

Editing Patch or Tone names is called Naming in this manual.

- A Patch name can have up to 18 letters.
- A Tone name can have up to 10 letters.

*The edited name is erased by changing Patches or turning the unit off.
To retain the new name, take an appropriate Writing procedure on page 92.

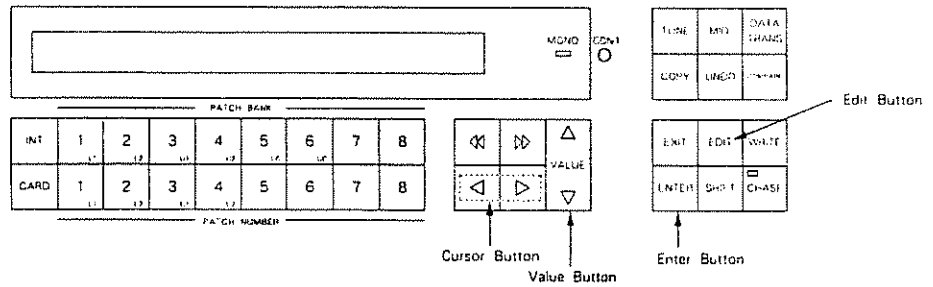

Step 1 Call the Patch to be named or the Patch that includes the Tone to be named.

Step 2 Push the Edit Button.

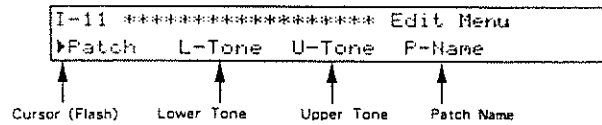

Step 3 Move the cursor to L-Tone, U-Tone or P-Name depending which name you wish to change, then push the Enter Button.

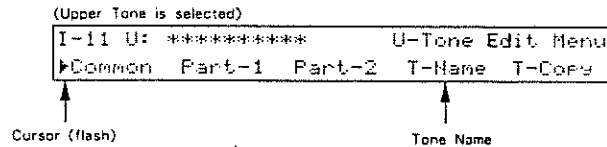

*If you select P-Name (Patch name), the Edit Display for the Patch Name is shown. Skip Step 4 and go to Step 5.

BASIC EDITING PROCEDURE

Step 4 Move the cursor to Tone Name in the Menu Display of the selected Tone, then push the Enter Button.

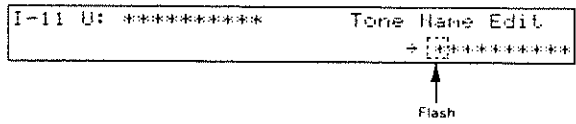

Step 5 Move the cursor to the letter you wish to change.

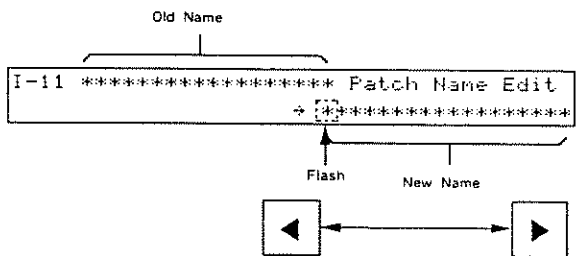

Step 6 Change the letters by using the Value Button.

The available letters are shown below.

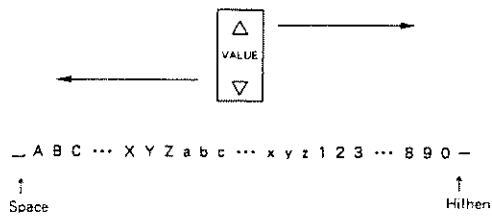

Step 7 Repeat Steps 5 and 6 as many times as necessary.

2 MIDI FUNCTIONS

MIDI Functions determine the way the MIDI messages are communicated.

*The MIDI Functions you have set are automatically written into memory and therefore are retained even after the unit is turned off.

1. Editing MIDI Functions

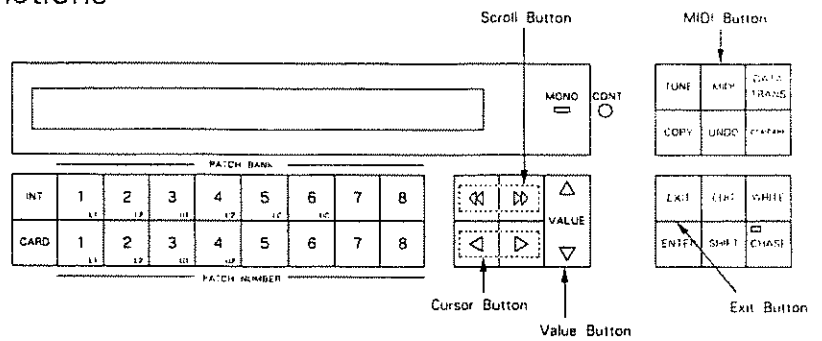

Step 1 Push the MIDI Button.

The MIDI-1 display is shown.

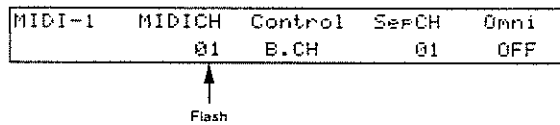

Step 2 There are four MIDI Function Displays, MIDI 1 to MIDI 4, which can be selected with the Scroll Buttons.

Step 3 Using the Cursor Buttons, move the cursor to the value of the Function to be edited.

Step 4 Using the Value Button, change the value.

Step 5 Push the Exit Button to return to the Play mode.

2. Description of the MIDI Functions

a. MIDI-1

MIDI-1:	MIDI CH	Control	Sep CH	Omni
	01	B.CH	01	OFF

● **MIDI CH: MIDI Channel**

This sets the Basic Channel 1 to 16. The transmit channel can be set to a different number from the Basic Channel for each Patch individually. (See page 48 "MIDI".)

● **Control: Control**

This determines how to receive messages from an external MIDI device.

[B.CH] and [G.CH] are effective when the unit is operating in the Mono mode. Normally, select [B.CH] (Basic Channel). If the external controlling unit uses the Global Channel (=one number smaller than the Basic Channel), select [G.CH], so that the D-550 can receive all the Voice Messages (except for Note Event and Pitch Bender messages) on the Global Channel.

With [MdeOFF] (Mode Messages OFF) selected, the D-550 does not receive Mode messages from the external unit, but is assigned to the Key Mode as set on the D-550. Select this when playing in the Solo Key Mode.(See page 39 "Key Mode".)

*Do not use Mode Messages OFF when operating the D-550 in the Mono mode.

● **Sep CH: Separate Channel**

This is the Receive Channel in the Separate Mode. When the Separate (Solo) Key Mode is selected, the Upper and Lower Tones can be controlled on different channels. The Basic channel controls the Lower Tone, and the channel set here controls the Upper Tone. 1 to 16 can be used for receive channels. Also, the receive channel of each Patch can be set to a different number from the channel set here.(See page 48 "MIDI".)

● **Omni: OMNI**

OMNI ON allows you to control the D-550 regardless of the MIDI channel of the external device. The OMNI setting can be retained even after the unit is turned off, but will be changed by the Mode messages sent from the external device.

b. MIDI-2

MIDI-2	After	Bender	Mod	Volume
	ON	ON	ON	ON

- **After: Aftertouch**
To receive Aftertouch messages, set this to ON.
- **Bender: Bender**
To receive Bender messages, set this to ON.
- **Mod: Modulation**
To receive Modulation messages, set this to ON.
- **Volume: Volume**
To receive Volume messages, set this to ON.

c. MIDI-3

MIDI-3	Hold	Porta	Prog.C	Exclu
	ON	ON	ON	ON

- **Hold: Hold**
To receive Hold messages, set this to ON.
- **Porta: Portamento**
To receive Portamento messages, set this to ON.
- **Prog.C: Program Change**
To receive Program Change messages, set this to ON.
- **Exclu: Exclusive**
To receive Exclusive messages (Roland ID Number only), set this to ON or P-Dump (Patch Dump). Normally, this is set to ON. P-Dump should be selected to record patch data into a device that can record Exclusive messages, such as a computer, the MC-500 (microcomposer), etc. When set to P-Dump, the Patch you select is transmitted to an external device. However, it cannot be transmitted by Patch selection via the Program Change messages sent from an external device.

*The transmit channel selected with "TxCH" in Patch Factor section (see page 48) controls Patch Dump.

MIDI FUNCTIONS

d. MIDI-4

Chase and volume balance of Tones can be controlled by Control Change messages sent from an external device.

MIDI-4	Control Change	Chase	ToneBal
		OFF	OFF

● **Chase : Chase**

You can assign any Control Number 66 to 95 for turning on or off the Chase function. If you do not want to turn on or off the Chase at all, assign this to the OFF position.

● **ToneBal : Tone Balance**

You can assign any Control Number from 0, 2, 3, 4 and 8 to 31 for controlling the volume balance of Tones. If you do not want to control the volume balance at all, assign this to the OFF position.

3 PATCH FACTORS

Performance controlling functions are called Patch Factors in this manual. A Patch consists of several Patch Factors as shown below.

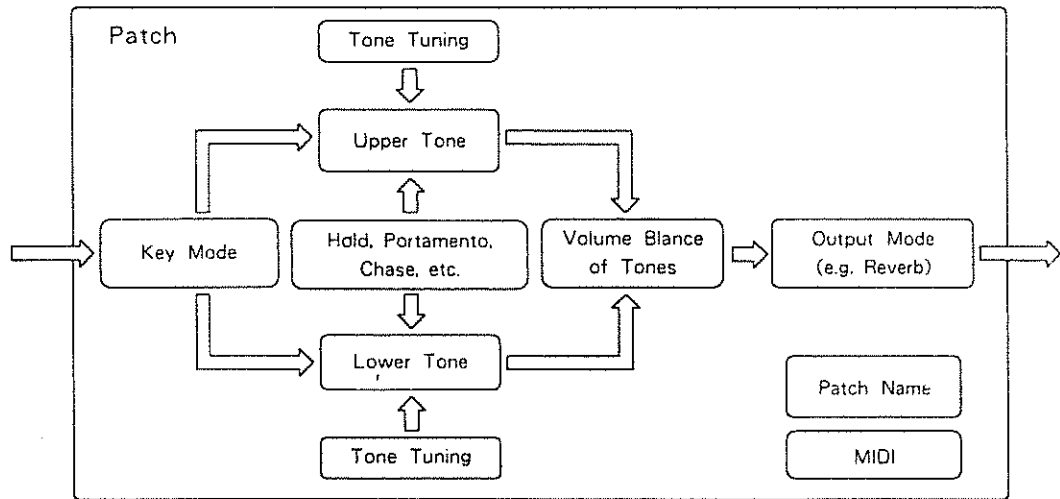

1. Editing Patch Factors

Either of the following two methods should be taken for editing depending on which Patch Factor is to be edited.

[Patch Factors in the Play Mode Display]

Editing Key Mode, Split Point and Volume Balance of Tones which are shown in the Play Mode Display :

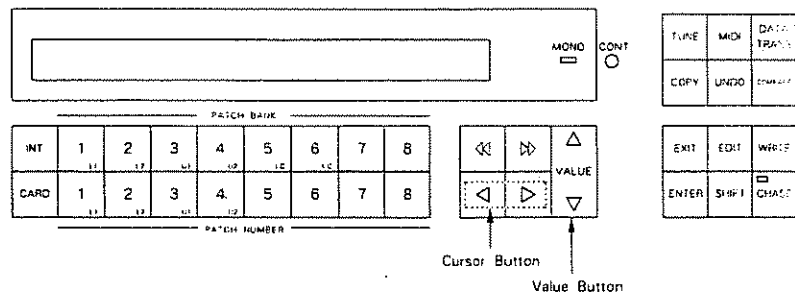

Step 1 Push either of the Cursor Buttons.

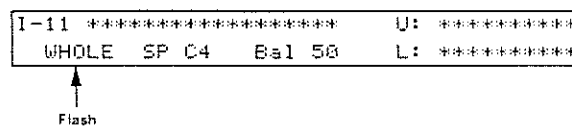

PATCH FACTORS

Step 2 Using the Cursor Buttons, move the cursor to the value to be changed.

Step 3 Using the Value Button, change the value.

[Other Patch Factors]

Editing other Patch Factors :

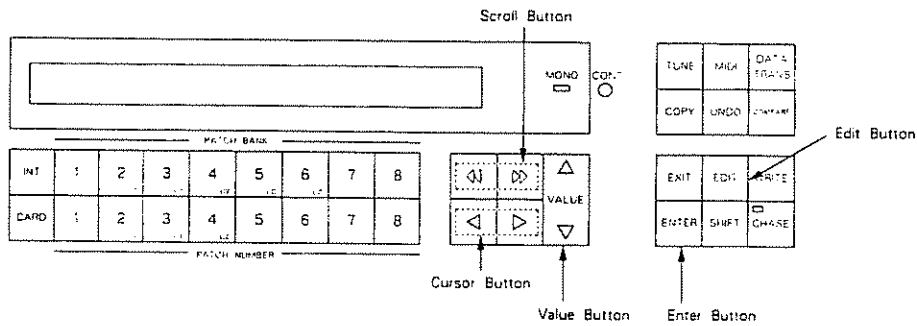

Step 1 Push the Edit Button.

[Display 1]

```
I-11 ***** Edit Menu
->Patch L-Tone U-Tone P-Name
```

↑
Cursor (flash)

Step 2 Push the Enter Button to call the Patch Edit menu.

[Display 2]

```
I-11 ***** Patch Edit Menu
->Control Output T-Tune Chase MIDI
```

↑ ↑ ↑ ↑ ↑
Cursor (flash) Output Mode Tone Tuning Chase MIDI
Patch Control

Step 3 Using the Cursor Buttons, select the item that contains the Factor you wish to edit, then push the Enter Button.

To change items at this stage, use the Scroll Button.

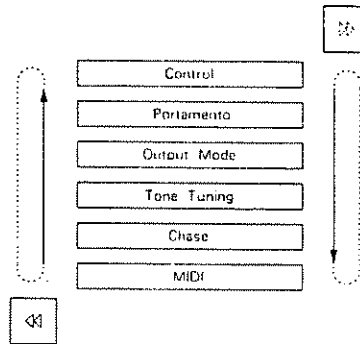

Step 4 Select the Factor to be edited with the Cursor Buttons.

Step 5 Using the Value Button, change the value.

2. Description of Patch Factors

This section describes all the Patch Parameters.

Each Display is numbered so you can refer to the Edit Map.

a. Key Mode (Split Point)

Key Mode determines how to output the Upper and Lower Tones.

```
I-11 ***** U: *****
      WHOLE SF C4 Bal 50 L: *****
```

↑
Flash

Poly/Mono mode is another element that determines how to output the Upper and Lower Tones.

PATCH FACTORS

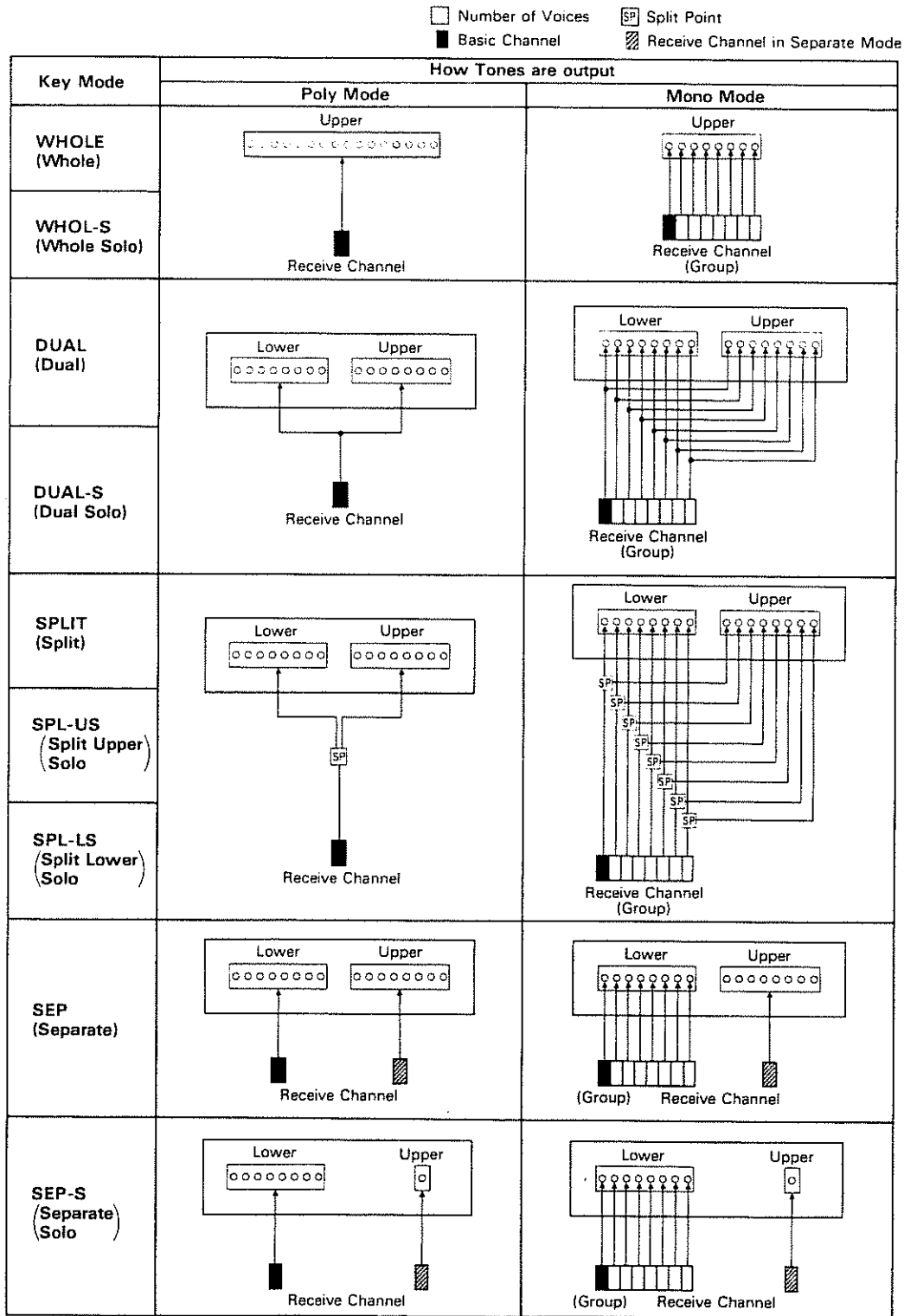

[Mode Messages OFF]

When Mode Message OFF is selected in the MIDI Function Control section (page 34), the way Tones are output varies depending on the Key mode, as shown below. When the Key mode is set to Whole, Dual, Split or Separate (Solo), the way the Tones are output is exactly same as in the Poly mode shown on page 40.

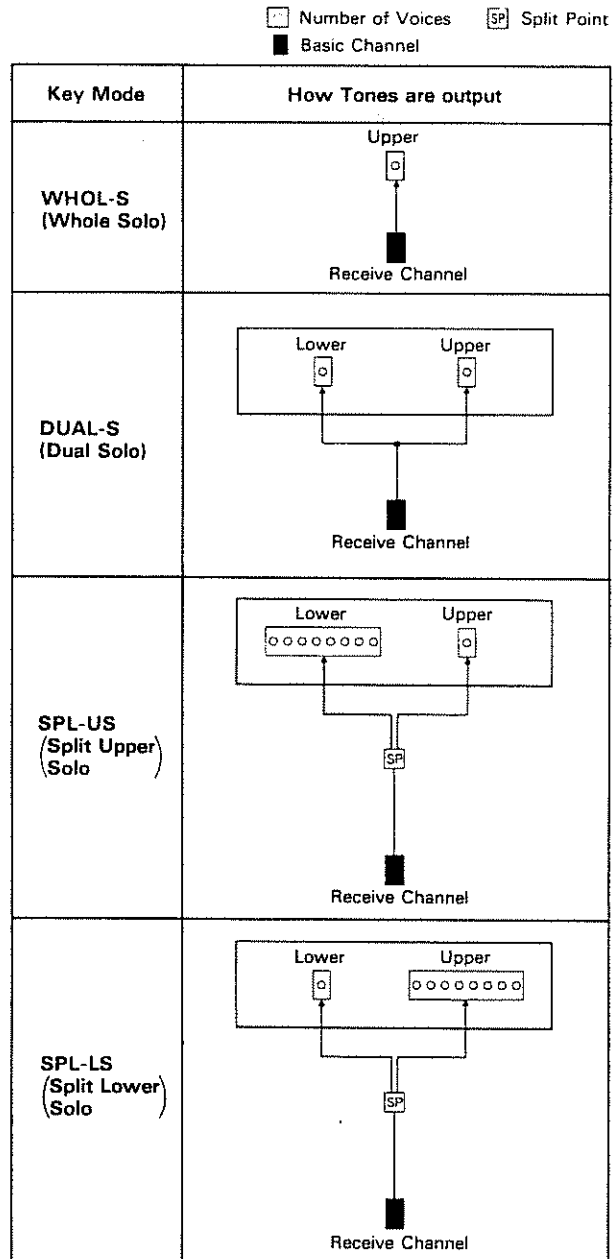

● SP : Split Point

```
I-11 ***** U: *****
  WHOLE SP C4 Ba1 50 L: *****
```



The Split Point can be set from C2 to C7, and is represented by a note name.

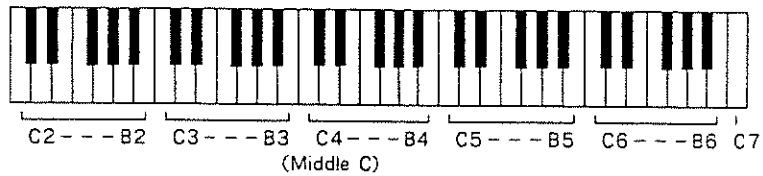

b. Volume Balance of the Tones

The volume balance of the Upper and the Lower Tones can be changed as follows.

```
I-11 ***** U: *****
  WHOLE SP C4 Ba1 50 L: *****
```



The value can be set from 0 to 100. Higher values increase the volume of the Upper Tone and decrease that of the Lower Tone.

c. Patch Control

Patch Controls determine how the Control Functions sent from an external device actually affect the Upper and the Lower Tones.

[Display 6]

```
I-11 ***** Control Edit
Bend 12 AffB+12      Hold UL
```

● **Bend: Bender Range**

This sets the variable range of the pitch alteration caused by moving the Bender lever, from 0 to 12 (1 octave).

● **AffB: Aftertouch (Pitch Bender)**

This sets the sensitivity of the aftertouch affecting the pitch from -12 to + 12. Higher values mean higher sensitivity. A minus setting decreases the pitch, and a plus setting increases it.

● **Hold: Hold Mode**

This selects the Tone that should take on the Hold effect.

U : Hold effect works on the Upper Tone.

L : Hold effect works on the Lower Tone.

UL : Hold effect works on both Tones.

*When the Key mode is set to Whole, the Hold effect always works whichever of the above three may be selected.

d. Portamento Mode

Portamento, a slide from one note to another, may be effectively used for particular sounds, such as a violin.

[Display 7]

```
I-11 ***** Portamento Edit
Time 00 Mode UL      PortOFF SepOFF
```

● **Time: Time**

This sets the Portamento time from one note to another from 1 to 100. Higher values make the time longer.

● **Mode: Mode**

This selects the Tone that should take on the Portamento effect.

U : Portamento works on the Upper Tone.

L : Portamento works on the Lower Tone.

UL : Portamento works on both Upper and Lower Tones.

*When the Key Mode is Whole, Portamento always works whichever of the above three modes may be selected.

[Portamento ON/OFF]

To obtain Portamento effects, you need to turn "Port" ON. If, however, the Separate (Solo) Key Mode is selected, the Upper Tone does not take on the Portamento effect. If you want Portamento on both Upper and Lower Tones, turn "Sep" ON.

*Even when "Port" is set to ON, the Portamento ON/OFF messages sent from an external device can change the settings of Portamento. When the Separate (Solo) mode is selected, the Portamento ON/OFF messages are received separately on each MIDI channel.

e. Output Mode

[Display 8]

```
I-11 ***** Output Mode Edit.
Mode 01 Rev 01 Rbal 50 Uol 50
```

●Mode : Output Mode

This selects one of the following four output modes.

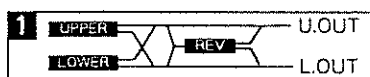

Stereo reverb works on the mixed sound of Upper and Lower Tones, and is sent out in stereo.

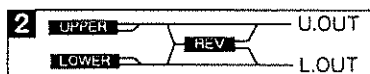

The Mixture of Upper and Lower takes on stereo reverb, and the direct sound is sent out separately for Upper and Lower.



Only the Upper Tone takes on reverb. Upper and Lower Tones are sent out separately.



Only the Lower Tone takes on reverb. Upper and Lower Tones are sent out separately.

●Rev : Reverb Type

This selects one of the following 32 reverb types.

REVERB TYPE

1	Small Hall	17	Bright Hall
2	Medium Hall	18	Large Cave
3	Large Hall	19	Steel Pan
4	Chapel	20	Delay (248ms)
5	Box	21	Delay (338ms)
6	Small Metal Room	22	Cross Delay (157ms)
7	Small Room	23	Cross Delay (252ms)
8	Medium Room	24	Cross Delay (274-137ms)
9	Medium Large Room	25	Gate Reverb
10	Large Room	26	Reverse Gate (360ms)
11	Single Delay (102ms)	27	Reverse Gate (480ms)
12	Cross Delay (180ms)	28	Slap Back
13	Cross Delay (224ms)	29	Slap Back
14	Cross Delay (148-296ms)	30	Slap Back
15	Short Gate (200ms)	31	Twisted Space
16	Long Gate (480ms)	32	Space

● **Rbal** : Reverb Balance

This sets the volume balance of reverb and direct sounds from 0 to 100. Higher values increase the volume of reverb sound, decreasing the direct sound.

● **Vol** : Total Volume

This sets the volume of both Tones from 0 to 100, and therefore adjusts the volume difference between Patches.

f. Tone Tuning

The relative pitch of the Upper and the Lower Tones can be separately set. By setting slightly different pitches, a detune effect can be obtained.

[Display 9]

```
I-11 ***** Tone Tune  
LKey 00 UKey 00 LTun 00 UTun 00
```

Also, by lowering the pitch of the Upper Tone, and raising the pitch of the Lower Tone, the pitches of the two Tones can become exactly the same.

● **LKey** : Lower Tone Key Shift

This allows you to shift the pitch of the Lower Tone in semi-tone steps from -24 to +24 (± 2 octaves).

● **UKey** : Upper Tone Key Shift

This allows you to shift the pitch of the Upper Tone in semi-tone steps from -24 to +24 (± 2 octaves).

● **LTun** : Lower Tone Fine Tune

This allows you to tune the pitch of the Lower Tone from -50 to +50 (approx. ± 50 cents).

● **UTun** : Upper Tone Fine Tune

This allows you to tune the pitch of the Upper Tone from -50 to +50 (approx. ± 50 cents).

g. Chase Play

The Chase Play function makes it possible to output the Lower Tone slightly later than the Upper Tone, or play Upper and Lower Tones alternately, and so on.

[Display 10]

```
I-11 ***** Chase Edit
ModeULU Lev1 50 Time 50
```

●Mode : Mode

This sets how the Tones sound :

1)When the Key Mode is Dual, the following choices are available.

UL : The Upper Tone then the Lower Tone is played.

ULL : The Upper, then the Lower is repeated.

ULU : The Upper, the Lower and the Upper Tone alternate.

2) When the Key Mode is Whole, the following choices are available

UL : The Upper Tone is played twice.

ULL: Upper Tone is repeated.

ULU: Upper Tone is repeated.

●Levl : Level

This sets the volume of the chase sound from 0 to 100. Higher values increase the volume.

●Time : Time

This adjusts the sounding time from 0 to 100. Higher values mean longer times.

*Depending on the Chase Level and Velocity, the number of repeats of the delayed sound differ. If "TVA Velocity Sens" (page 86) is set to 0, the sound does not decay but repeats with the same volume.

PATCH FACTORS

h. MIDI

The following are MIDI Functions which can be individually set for each Patch.

[Display 11]

I-11 ***** MIDI Channel
TxCH B SepCHOFF

● **TxCH: Transmit Channel**

The transmit channel of each Patch can be set to the same number as the basic channel, or a different number from 1 to 16.

● **SepCH: Receive Channel in Separate Mode**

A receive MIDI channel in the Separate mode can be set to from 1 to 16, or OFF. At OFF, the receive channel set in "SepCH (page 34) in MIDI Functions is used.

4 AN OUTLINE OF TONE PARAMETERS

1. THE BASIC CONCEPT OF A TONE

A Tone consists of **two Partials** (Partial 1 and 2) and a **Common** block.

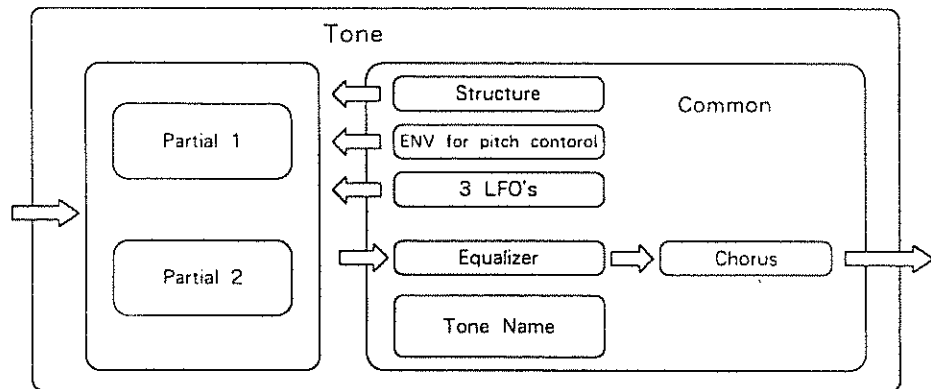

Each Partial (Partial 1 and Partial 2) can have one of two sound generators (a **Synthesizer sound source** or a **PCM sound source**). So you can think of the D-550 having powerful synthesizers built in. Each of these hypothetical synthesizers could behave like a conventional analog synthesizer, or a PCM sampled synthesizer. Any combination of two synthesizers can achieve some remarkable cross-modulation effects, so characteristic of today's purely digital sounds.

Some Common parameters apply to both Partials (Partial 1 and 2). "Structure" is one of the Common parameters. It decides which of the two sound generators is used for each Partial. Other Common parameters are an ENV for pitch, three LFO modules, equalizer, chorus, etc.

{STRUCTURE}

Structure, which is one of the Common parameters, determines which two of the hypothetical synthesizers (a synthesizer sound generator or a PCM sound generator) are to be used as Partial 1 and Partial 2.

A "Synthesizer sound generator" works like a conventional analog type synthesizer with an oscillator, a filter, an amplifier and two ENV's. A PCM sound generator provides 100 different PCM sampled sounds.

These two Partial sounds (Partial 1 and Partial 2) can simply be mixed as shown below.

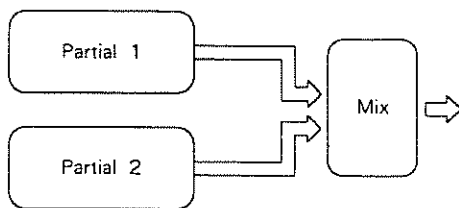

By mixing two Partials, fatter sounds can be obtained. This is effective for making strings or organ type sounds.

Or Partial 1 can be mixed with the ring-modulated sound of Partials 1 and 2.

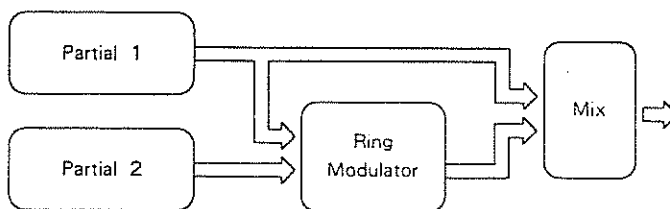

The Ring Modulator multiplies two sounds, creating an unusual and metallic sound that contains complicated harmonics. For instance, two waveforms (① and ②) are multiplied and waveform ③ is created. This is effective for making metallic sounds.

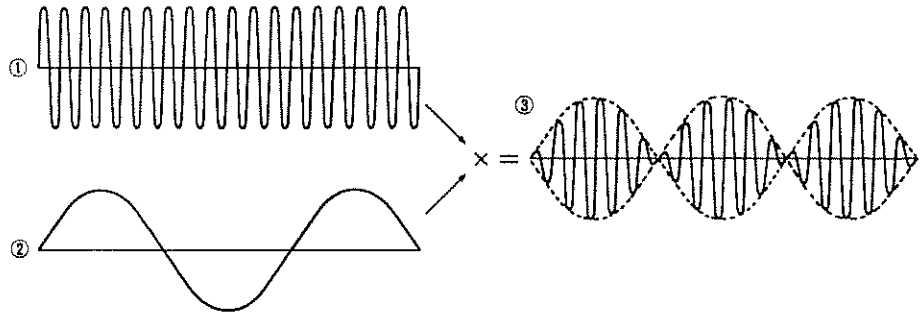

2. STRUCTURE OF TONE PARAMETERS

Depending on which generators are selected in the Partial Block, greatly different Tone Parameters will be used. Some Tone Parameters used for the Synthesizer sound generators are irrelevant to the PCM generator (see the diagram below).

In a Structure with Ring modulation, some parameters of Partial 2 are automatically set to those of Partial 1. See page 63 "Tone Parameters" for a detailed explanation.

AN OUTLINE OF TONE PARAMETERS

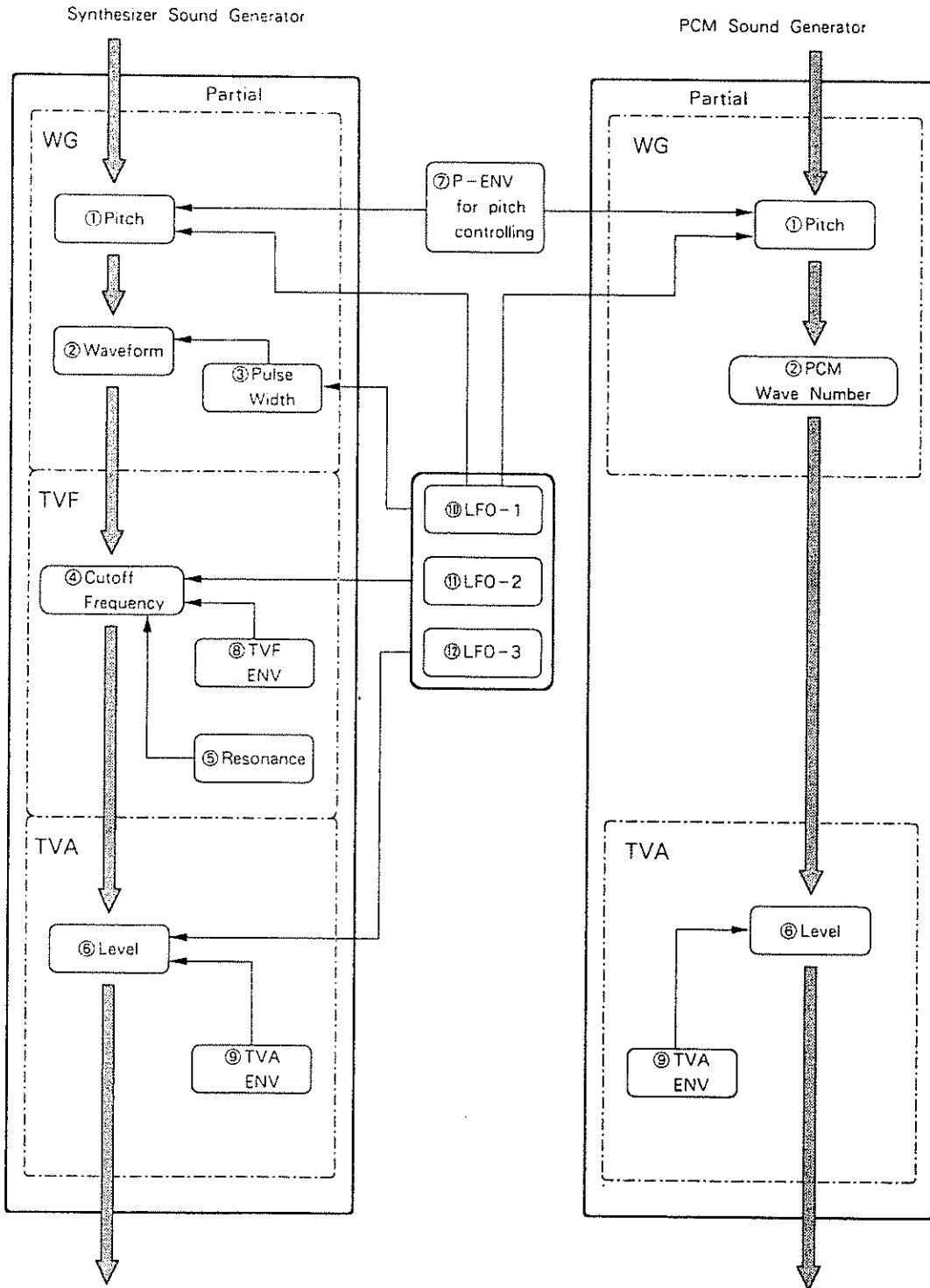

a. WG (Wave Generator)

In the WG (Wave Generator), the pitch and waveform are controlled.

① Pitch

The basic pitch of a Partial (sound generator) can be set here. The pitch is a Common parameter, and is therefore controlled by ⑦ P-ENV and ⑩ LFO-1.

② Waveform (PCM Wave Number)

This selects the waveform of the sound source. When a synthesizer sound generator is selected, the waveform can be controlled by the ③ Pulse Width controls.

③ Pulse Width

This changes the waveform of the sound source. The pulse width is controlled by any LFO (=Common parameter).

b. TVF (Time Variant Filter)

This filter passes lower frequency harmonics and cuts off the higher ones. By changing the cutoff point and the resonance, the waveform changes.

④ Cutoff Frequency

This sets the cutoff point. The cutoff point can be controlled by ⑧ TVF ENV and any LFO (=Common parameter).

⑤ Resonance

This emphasizes the cutoff point, making more unusual or electronic sounds.

c. TVA (Time Variant Amplifier)

This controls the volume of the Partial.

⑥ Level

This determines the volume of the sound. When a synthesizer sound generator is used, the level can be controlled with the ⑨ TVA ENV and any LFO (Common parameter). When a PCM sound generator is used, the ⑨ TVA ENV controls the level.

d. ENV (Envelope Generator)

This generates a control signal (envelope curve) which controls the pitch, timbre and volume of each Partial (sound generator).

⑦ P-ENV

This is the ENV which controls pitch. It can be set for two selected Partial at once.

⑧ TVF ENV

This ENV controls the cutoff point, and can be set for each Partial separately.

⑨ TVA ENV

This ENV controls the volume level. This can be set for each Partial separately.

e. LFO (Low Frequency Oscillator)

This oscillator generates low frequencies only.
Any of the three LFO's can be used for the two Partials. Vibrato, PWM growl or tremolo effects can be obtained using these LFO's.

*A different LFO can be used for each section or a PARTIAL.

⑩ LFO-1

This can control ① Pitch, ③ Pulse Width, ④ Cutoff Frequency or ⑥ Level.

⑪ LFO-2

This can control ③ Pulse Width, ④ Cutoff Frequency or ⑥ Level.

⑫ LFO-3

This can control ③ Pulse Width, ④ Cutoff Frequency or ⑥ Level.

5 TONE EDITING

For Tone editing, some additional editing functions are available as well as those listed at the beginning of the Edit Mode section of this manual.

1. Changing Parameter Displays

While editing a tone parameter of one Partial, you can call the Display of the same parameter for a different Partial. This also applies when moving from a Common to another Common Display. This can save substantial amounts of time and work, that otherwise would be required to exit the Tone Parameter editing mode, then go to the parameter.

Step 1 Push the Edit Button to enter the Editing mode. Now, any of the Tone Block menu displays can be called by using the corresponding buttons.

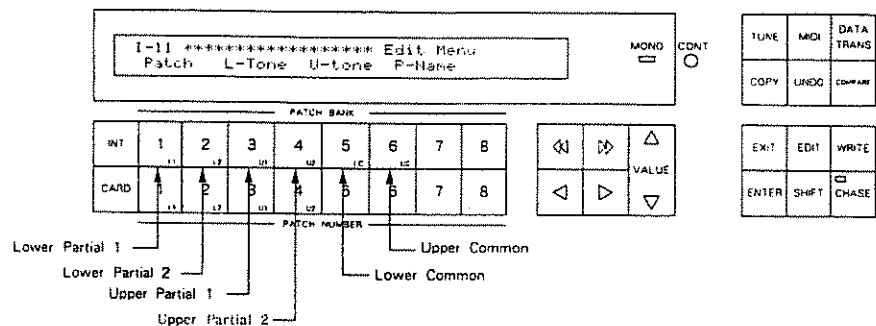

Step 2 Go down to the further Displays, other than a Menu Display, and you can change to the Display that shows the same parameter for a different Partial (or Common) by taking the same procedure as step 1.

*Even when the Display is changed, the value of the parameter currently selected will still be flashing.

*The condition of the selected Display is retained even after you move to Patch Factor editing, therefore it can be recalled by pushing the Patch Bank Button.

tone editing

[e.g.]

When a TVA Display of a Partial is selected, the TVA displays of other Blocks can be called using the Patch Buttons 1 to 4.

When an EQ Display of a Common is selected, the EQ Display of another Block can be called using the Patch Button 5 or 6.

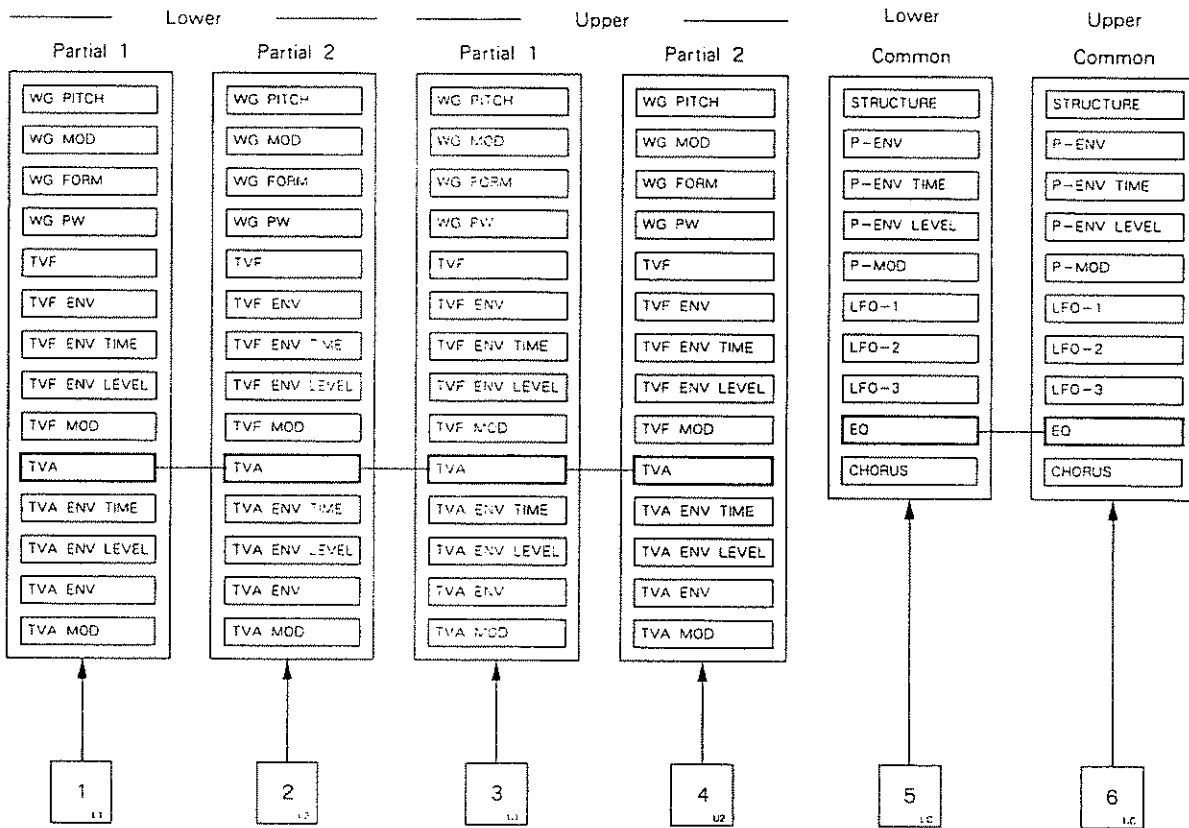

2. Editing Functions

a. Copy

The Copy function can copy the parameters of a Tone or Block to a different location.

[Tone Copy]

A Tone from another Patch can be copied to the Patch currently selected.

Step 1 Call the Tone Copy Display.

- To copy to the Upper Tone, assign "Tone Copy" from the Upper Tone Menu Display.
- To copy to the Lower Tone, assign "Tone Copy" from the Lower Tone Menu Display.

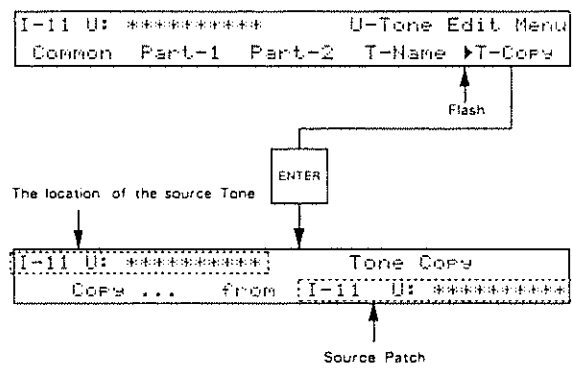

Step 2

Select the Tone to be copied by using the appropriate button, as you actually listen to the sound, and it will be copied to the Tone of the currently selected Patch.

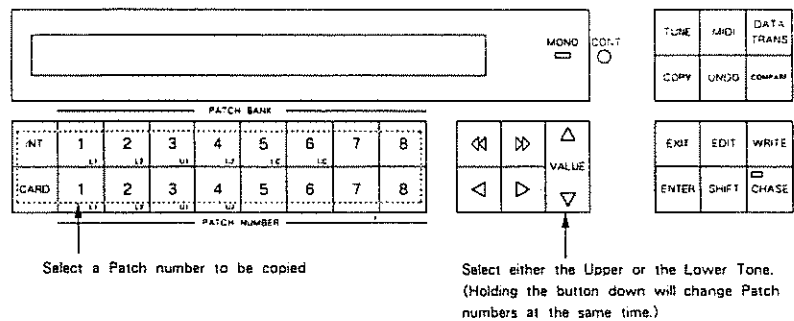

*At this stage, changing the Display will show the Tone Name just copied.

[Parameter Copy]

A group of Tone Parameters can be copied within a Patch.

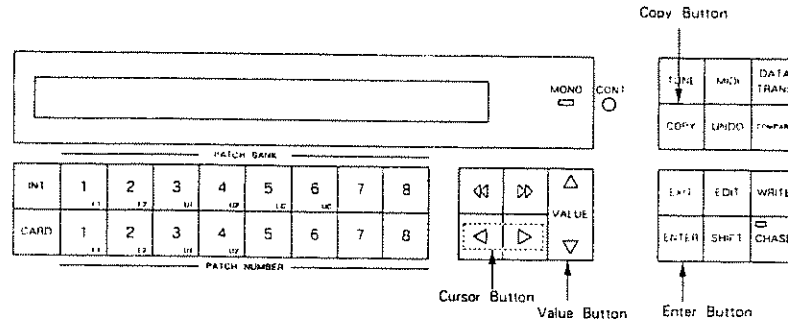

Step 1 Push the Copy Button.

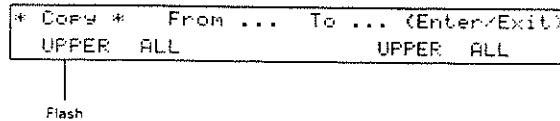

Step 2 Using the Cursor Button, select the necessary item, then assign the Block to be copied and the destination Block using the Value Button.

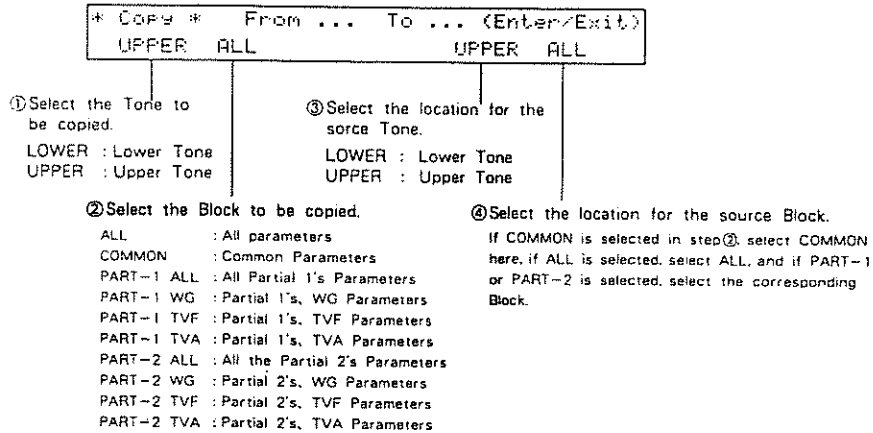

To cancel the copying mode, push the Exit Button.

Step 3 Push the Enter Button.

When the copy is completed, the Display responds as shown below, then returns to the Play mode indication.

A rectangular box representing a display screen. Inside the box, the text "Complete ." is centered.

*If you try to copy a Common parameter to a Partial parameter or vice versa, the Display will show the following error message and copying cannot be achieved.

A rectangular box representing a display screen. Inside the box, the text "Data Mismatch" is on the top line and "Cancel ..." is on the bottom line, both centered.

TONE EDITING

b. Partial Mute

While editing a Partial parameter, any Partial sound can be muted. This function can be used in any Partial Display.

Simply push the Patch Number Button (1 to 4) that corresponds to the Partial to be muted.

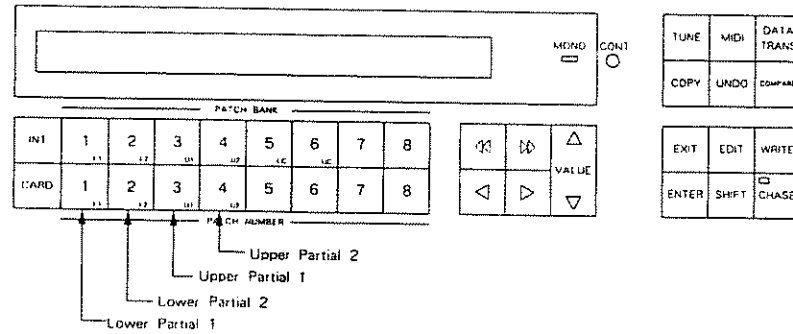

The mute status of all Partial is shown in any Partial Display.

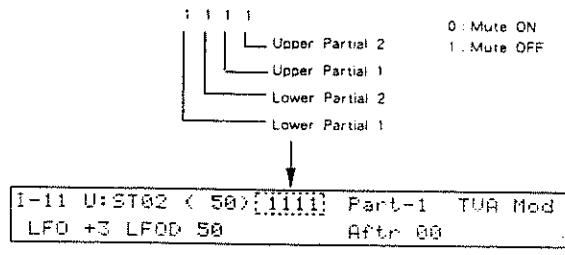

*The Partial Mute setting will be automatically written into memory by taking the Writing procedure on page 92.

c. Partial Balance

While editing a Partial parameter, you can change the volume balance of the Partial sounds which belong to the selected Tone. The Partial Balance function can be obtained in any Edit Display.

A Partial Display shows the value of the Partial Balance.

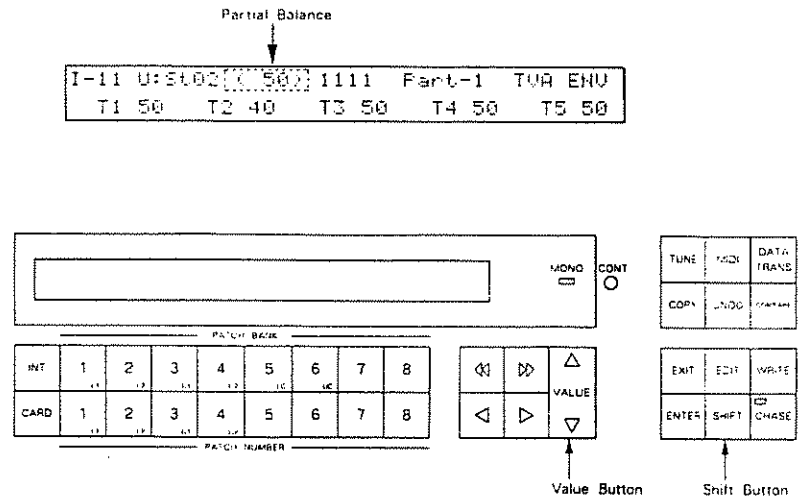

While holding the Shift Button down, change the value of the Partial Balance with the Value Button 0 to 100. Higher values increase the volume of Partial 2, decreasing Partial 1.

3. Initializing a Partial

The entire parameter settings of a Partial can be returned to the default settings (= initialization). This is useful when creating a sound from scratch.

Step 1 Select "Init" from the Menu Display of the Partial to be initialized.

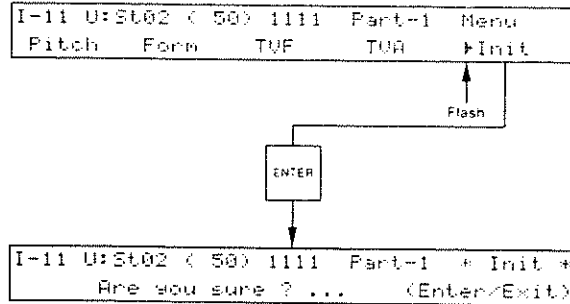

Step 2 Push the Enter Button.

When all the parameters are initialized, the Display will respond as below for a few seconds.

```
Complete .
```

6 TONE PARAMETERS

Each Display is numbered as shown in the Edit Map.

1. COMMON PARAMETERS

a. Structure

[Display 17]

```
I-11 U: ***** Structure
Str 02 (S S R)
```

● **Str** : Structure Number

Select one of the following seven Structures.

The Display shows the number you select and the contents of the structure.

S (Synthesizer Sound Generator)

P (PCM Sound Generator)

R (Ring Modulator)

Structure Number	Partial 1	Partial 2	Combination of two Partials	Block Diagram
1	S	S	Mixture of Partial 1 and Partial 2.	
2	S	S	Mixture of Partial 1 and ring-modulation.	
3	P	S	Mixture of Partial 1 and Partial 2.	
4	P	S	Mixture of Partial 1 and ring-modulation.	
5	S	P	Mixture of Partial 1 and ring-modulation.	
6	P	P	Mixture of Partial 1 and Partial 2.	
7	P	P	Mixture of Partial 1 and ring-modulation.	

TONE PARAMETERS

b. P-ENV

[Display 18]

```
I-11 U: ***** P-ENV Edit
Uelo 00 TKF 00
```

● **Uelo : Velocity Range**

This sets the maximum effect of the velocity that controls the pitch of the P-ENV. 0 to 2 are valid. At higher values, the keyboard velocity has a greater effect on the envelope.

● **TKF : Key Follow (Time)**

This sets the time of the P-ENV depending on the key played 0 to 4 are valid. Higher values change the time more drastically.

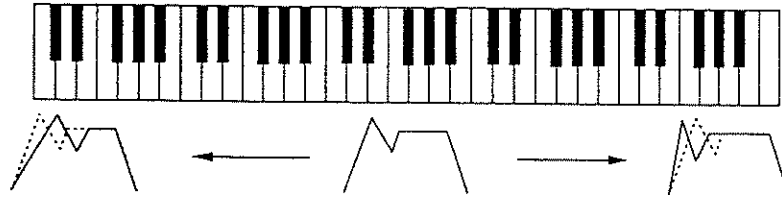

[Display 19]

```
I-11 U: ***** P-ENV Edit
T1 50 T2 50 T3 50 T4 50
```

[Display 20]

```
I-11 U: ***** P-ENV Edit
L0 00 L1 00 L2 00 SusL 00 EndL 00
```

The envelope curve is determined by times and levels.

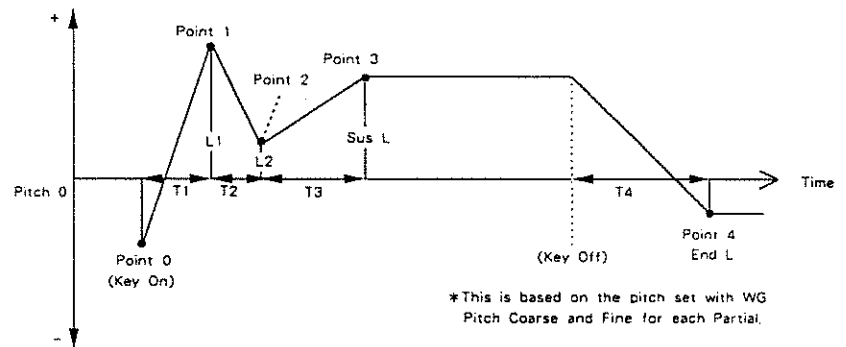

● **T1 : Time 1**

This sets the time needed from point 0 (the moment the key is pressed) to point 1. 0 to 50 are valid.

● **L0 : Level 0**

This sets the pitch created the moment a key is pressed from -50 to +50.

● **T2 : Time 2**

This sets the time needed from point 1 to point 2. 0 to 50 are valid.

● **L1 : Level 1**

This sets the pitch of the point 1 from -50 to +50.

● **T3 : Time 3**

This sets the time needed from point 2 to point 3. 0 to 50 are valid.

● **L2 : Level 2**

This sets the pitch of point 2 from -50 to +50.

● **Sus L : Sustain Level**

This sets the pitch of point 3 from -50 to +50.

● TONE PARAMETERS

● **T4 : Time 4**

This sets the time needed from the moment the key is released to point 4. 0 to 50 are valid.

● **EndL : End Level**

This sets the pitch of point 4 from -50 to +50.

*If the Levels of two adjacent points are set to similar values, the time between these two points may prove to be shorter than what is actually set, or even zero.

*The variable range of each level is determined by the Velocity range [Display 18].

Velocity Range	Level	Variable Range
0	+50	+1 octave
	-50	-1 octave
1	+50	+1.5 octave
	-50	-1.5 octave
2	+50	+2 octave
	-50	-2 octave

c. Pitch Modulation

[Display 21]

I-11 U: *****	Pitch Mod Edit
LFOD 50	Levr100 Aftr100

*Depending on how the LFO in WG modulation (Display 28) is set, the vibrato set here may have no effect at all. Higher values deepen the effect.

● **LFOD: LFO Depth**

This sets the depth of LFO-1, that controls the WG pitch. 0 to 100 are valid.

● **Levr: Pitch Lever Modulation**

This sets the sensitivity of the vibrato depth controlled by the bender lever from 0 to 100. Higher values deepen the effect.

● **Aftr: Pitch Aftertouch Modulation**

This sets the sensitivity of the vibrato depth controlled by aftertouch from 0 to 100. Higher values deepen the vibrato effect.

TONE PARAMETERS

d. LFO



[Display 22-24]

```
I-11 U: ***** LFO-1 Edit
WaveTRI Rate 00 Delx 00 SyncOFF
```

*The parameters of LFO-2 (Display 22) and LFO-3 (Display 23) can be set like LFO-1, except for a few parameters.

● **Wave: Waveform**

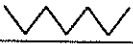
This selects the waveform of the LFO.

Display	Waveform
TRI (Triangle)	
SAW (Sawtooth)	
SQU (Square)	
RND (Random)	Waveform changes randomly.

● **Rate: Rate**

This sets the rate (frequency) of the LFO from 0 to 100. Higher values quicken the rate.

● **Delx: Delay Time**

This sets the time needed for the LFO to appear, from the moment a key is pressed. 0 to 100 are valid. Higher values increase the delay time.

● **Sync: Sync**

This selects the timing of the LFO oscillation as follows.

Display	Description
OFF	LFO does not sync to the keyboard.
ON	When a key is played after all keys have been released, the LFO begins its wave generating process from the beginning.
KEY	LFO begins its wave generation from the beginning each time a new key is played.

*For LFO-2 and LFO-3, "KEY" cannot be selected.

e. Equalizer

[Display 25]

```

I-11 U: ++++++ EQ Edit
Lf 63 Lg 00 Hf 250 HQ 2.0 Hg 00
    
```

In the equalizer section, the frequency characteristic of the sound can be modified.

The Equalizer consists of the following parameters.

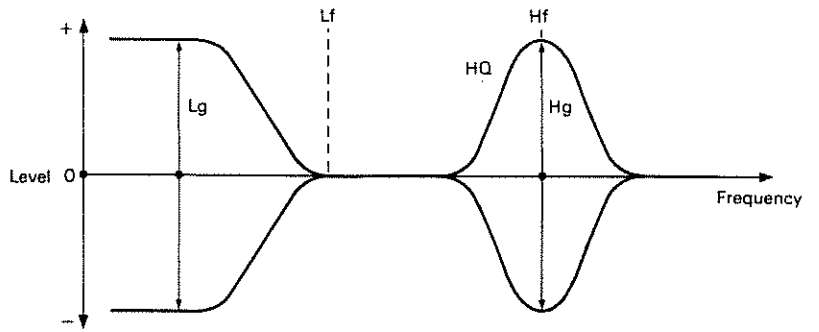

● Lf

This sets the frequency where the gain is altered in the low to middle range. 63Hz to 840Hz (16 points) are valid.

● Lg

This sets the gain of the lower Frequencies in 1dB steps, from -12 to +12dB (25 points). "+" settings raise the gain, and "-" settings lower it.

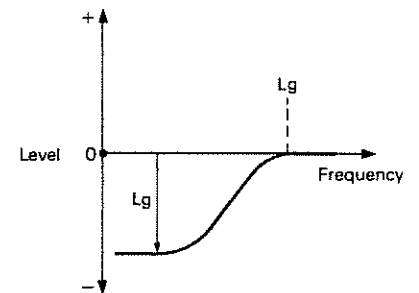
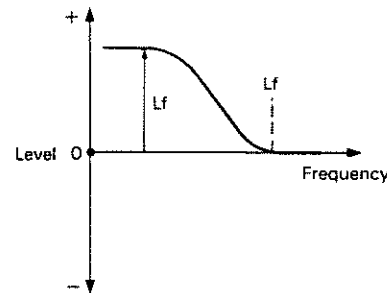

TONE PARAMETERS

- **Hf**

This sets the frequency where the gain is altered in the middle to high range, from 250Hz to 9.5kHz (22 points).

- **HQ**

This sets the width of the frequency band where the gain is boosted or cut from 0.3 to 6.0 (9 points). With a higher value, the frequency band is narrower, and vice versa.

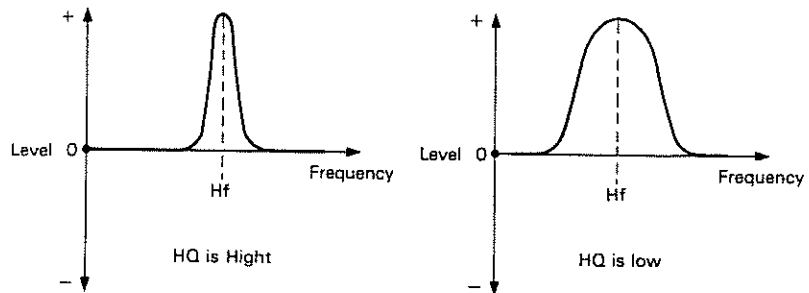

- **Hg**

This sets the gain of the Hf frequency from -12 to +12dB (in 1dB step, 25 points). "+" settings raise the gain and "-" settings lower it.

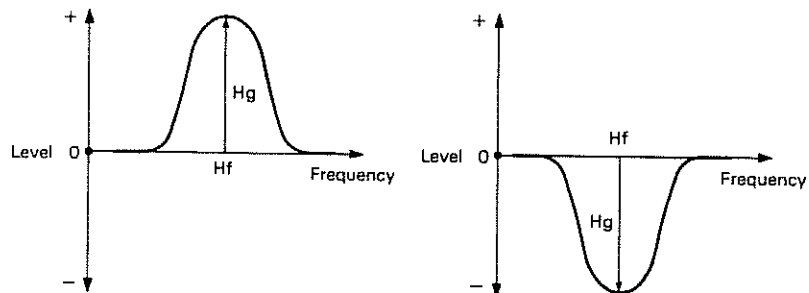

f. Chorus

[Display 26]

I-11	U: *****	Chorus Edit
Type	01	Rate 50 Depth 50 Bal 50

● **Type : Chorus Type**

This selects one of the 8 basic chorus effects.

1	Chorus 1
2	Chorus 2
3	Flanger 1
4	Flanger 2
5	Feedback Chorus
6	Tremolo
7	Chorus Tremolo
8	Dimension

● **Rate : Chorus Rate**

This sets the rate of the chorus effect, from 0 to 100. Higher values quicken the rate.

● **Depth : Chorus Depth**

This sets the depth of the chorus effect, from 0 to 100. Higher values deepen the effect.

● **Bal : Chorus Balance**

This sets the volume balance of the chorus sound and normal sound, from 0 to 100.

100 Only the chorus sound is heard.
 }
 50 Chorus sound = Normal sound
 }
 0 Only the normal sound is heard.

2. PARTIAL PARAMETERS

[Restriction of the available parameters caused by Structure]

Depending on what Structure is used, the available parameters may be different. So, first check the Structure number shown in the Partial Display, then set the parameters.

Structure Number
↓

I-11	U:St02	(50)	1111	Part-1	Menu
Pitch	Form	TUF	TUR	Init	

1) In some Structures, some parameters included in a Partial that uses a PCM sound generator are invalid. The following mark is shown when the parameters apply even for PCM sounds.

PCM

2) In some Structures which use Ring Modulation, some parameters in Partial 2 will automatically become the same as for Partial 1. Therefore, the values shown in the Display are irrelevant with the actual values. The following mark is shown for such parameters.

Ring

a. WG Pitch

[Display 27]

I-11	U:St02	(50)	1111	Part-1	WG Pitch
ConsC4	Fine	00	KF	1	

● **Cons** : Pitch Coarse **PCM**

This sets the standard pitch of a Partial in semi-tone steps from C1 to C7.

*The standard pitch is the pitch at C4 (middle C) key.

● **Fine** : Pitch Fine **PCM**

The standard pitch can be altered over about ± 50 cents from -50 to $+50$.

● **KF** : Key Follow (Pitch) **PCM**

Usually, the keyboard of a synthesizer assigns a semi-tone to each key. This parameter can change the pitch ratio as shown below.

The value represents how many octaves are changed over 12 keys.

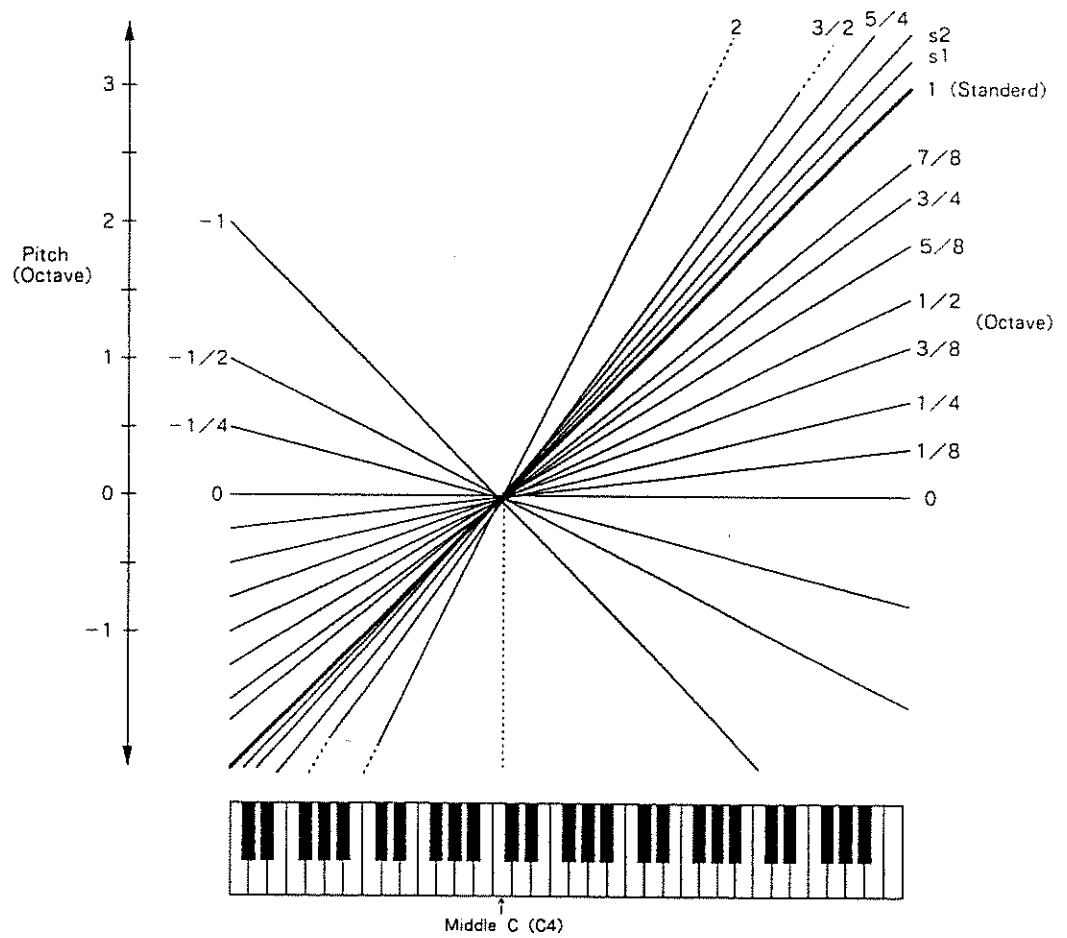

*s1 or s2 may be selected for slightly stretching octaves.

s1 : Pitch 1 cent higher than one octave.

s2 : Pitch 5 cents higher than one octave.

b. WG Modulation

[Display 28]

```
I-11 U:ST02 < 50> 1111 Part-1 WG Mod
LFO (+) ENV (-) BendKEY
```

● LFO: LFO Mode **PCM**

This selects one of the following four vibrato modes.

Display	Description
OFF	No vibrato is obtained.
(+)	Vibrato is on.
(-)	Vibrato is on but inverted.
A&L	Vibrato can be obtained only by Aftertouch and Bender Lever.

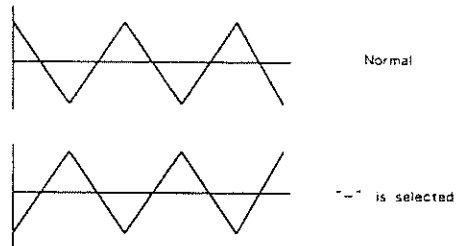

● ENV: P-ENV Mode **PCM**

This selects one of the following three modes, determining how the pitch is controlled by P-ENV.

Display	Description
OFF	No alteration.
(+)	Pitch changes with the set P-ENV curve.
(-)	Pitch changes with the P-ENV curve inverted.

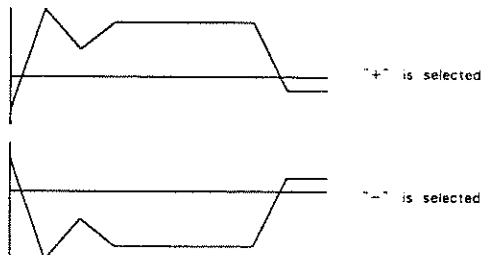

● Bend: Bender Mode **PCM**

This selects how the pitch is controlled by the bender lever as follows.

Display	Description
OFF	No pitch alteration by moving the Lever right or the left.
KEY	Pitch changes within the Bender range, set in Patch Factors, plus Key Follow (Pitch) of WG. (See the example shown right.)
NOM	Pitch changes within the Bender range, set in Patch Factors.

[Example]

If the Bender range is set to 12 (1 octave), and the Key Follow (Pitch) of WG is set to 2, the maximum pitch change caused by moving the Bender lever is 2 octaves. When the Key Follow (Pitch) of WG is set to zero, there is no pitch change caused by the Bender lever.

c. WG Waveform



[Display 29]

```
I-11 U:St02 ( 50)1111 Part-1 WG Form
WaveSQU PCM 01:Martha
```

↑
PCM Name

● **Wave : Waveform**

This selects the waveform of the synthesizer sound generator.

Display	Waveform
SQU (Square)	
SAW (Sawtooth)	

*A sawtooth waveform is produced by processing a square waveform at the TVF, that is, all the waveforms are square at WG even when a sawtooth is selected.

● **PCM : PCM Wave Number** **PCM**

This selects one of the 100 different sampled waves of the PCM sound generator. Each sample is named (PCM name) as shown on the next page :

TONE PARAMETERS

- 1~47 (One Shot sounds are programmed.)
- 48~76 (Looped sounds are programmed.)
- 77~100 (Some of the sounds 1 to 76. are combined and looped.)

Number	Display	PCM Name	Number	Display	PCM Name
1	Marmca	Marmca	51	EP_lp1	Electric Piano (Loop 1)
2	Vibes	Vibraprone	52	EP_lp2	Electric Piano (Loop 2)
3	Xylo1	Xylophone 1	53	CLAV1p	Clavi (Loop)
4	Xylo2	Xylophone 2	54	HC_lp	Harpsichord (Loop)
5	Log_Bs	Log Bass	55	EB_lp1	Electric Bass (Loop 1)
6	Hammer	Hammer	56	AB_lp	Acoustic Bass (Loop)
7	JpnDrum	Japanese Drum	57	EB_lp2	Electric Bass (Loop 2)
8	Kalimba	Kalimba	58	EB_lp3	Electric Bass (Loop 3)
9	Pluck1	Pluck 1	59	EG_lp	Electric Guitar (Loop)
10	Chink	Chink	60	CELLlp	Cello (Loop)
11	Agogo	Agogo	61	VIOLlp	Violine (Loop)
12	Jangle	Triangle	62	Reedlp	Lead (Loop)
13	Bells	Bell's	63	SAXlp1	Sax (Loop 1)
14	Nails	Nail File	64	SAXlp2	Sax (Loop 2)
15	Pick	Pick	65	Aah_lp	Aah (Loop)
16	Lpiano	Low Piano	66	Ooh lp	Ooh (Loop)
17	Mpiano	Mid Piano	67	Manlp1	Male (Loop 1)
18	Hpiano	High Piano	68	Spect1	Spectrum 1 (Loop)
19	Harpsi	Harpsichord	69	Spect2	Spectrum 2 (Loop)
20	Harp	Harp	70	Spect3	Spectrum 3 (Loop)
21	OrgPrc	Organ Percussion	71	Spect4	Spectrum 4 (Loop)
22	Steel	Steel Strings	72	Spect5	Spectrum 5 (Loop)
23	Nylon	Nylon Strings	73	Spect6	Spectrum 6 (Loop)
24	Eguit1	Electric Guitar 1	74	Spect7	Spectrum 7 (Loop)
25	Eguit2	Electric Guitar 2	75	Manlp2	Male (Loop 2)
26	Dirt	Dirty Guitar	76	Noise	Noise (Loop)
27	P_Bass	Pick Bass	77	Loop01	
28	Pop	Pop Bass	78	Loop02	
29	Thump	Thump	79	Loop03	
30	Uprite	Upright Bass	80	Loop04	
31	Clarnt	Clarinet	81	Loop05	
32	Breath	Breath	82	Loop06	
33	Steam	Steamer	83	Loop07	
34	FluteH	High Flute	84	Loop08	
35	FluteL	Low Flute	85	Loop09	
36	Guira	Guira	86	Loop10	
37	IndFlt	Indian Flute	87	Loop11	
38	Harmo	Flute Harmonics	88	Loop12	
39	Lips1	Lips 1	89	Loop13	
40	Lips2	Lips 2	90	Loop14	
41	Trump1	Trumpet	91	Loop15	
42	Bones	Trombones	92	Loop16	
43	Contra	Contrabass	93	Loop17	
44	Cello	Cello	94	Loop18	
45	VioBow	Violin Bow	95	Loop19	
46	Viols	Viols	96	Loop20	
47	Pizz	Pizzicart	97	Loop21	
48	Drawbr	Draw bars (Loop)	98	Loop22	
49	Horgan	High Organ (Loop)	99	Loop23	
50	Lorgan	Low Organ (Loop)	100	Loop24	

d. WG Pulse Width

[Display 30]

```

I-11 U:ST02 < 50> 1111 Part-1 WG PW
PW 00 Velo 00 Aftr 00 LFO +1 LF00 50

```

●PW: Pulse Width

A square waveform has exactly the same width, up and down but a Pulse Width waveform has different widths. The ratio of upper width to lower is called pulse width, 0 to 100 are valid for setting the pulse width. Depending on the set pulse width value, the harmonic content of the sound changes greatly.

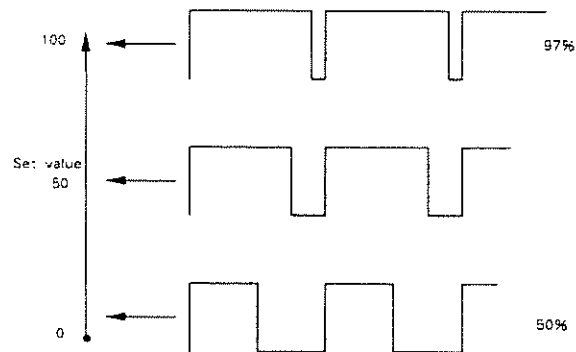

*When a sawtooth is selected with WG Waveform, pulse width 50% raises the pitch by an octave.

●Velo: Velocity Range

This sets the sensitivity of the velocity that controls the pulse width from -7 to +7. With "-" values, the pulse width becomes smaller by playing the keyboard harder, and with "+" values, the pulse width becomes wider by playing the keyboard harder.

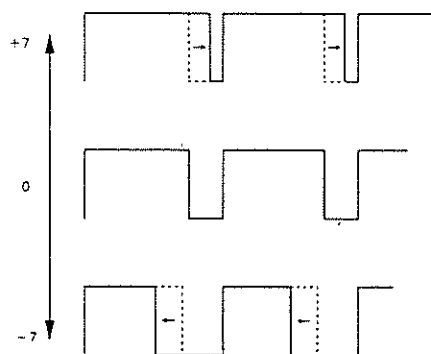

● **AFT**: Aftertouch Range **Ring**

This sets the sensitivity of the aftertouch that controls the pulse width from -7 to +7. With "-" values, the pulse width becomes smaller with stronger aftertouch, and with "+" values, the pulse width becomes wider with stronger aftertouch.

● **LFO**: LFO Select **Ring**

Pulse Width Modulation (PWM) means changing the pulse width periodically. LFO Select decides which of the LFO's is to be used for modulating the pulse width.

Display	LFO (Phase)
+1	LFO-1 (+)
-1	LFO-1 (-)
+2	LFO-2 (+)
-2	LFO-2 (-)
+3	LFO-3 (+)
-3	LFO-3 (-)

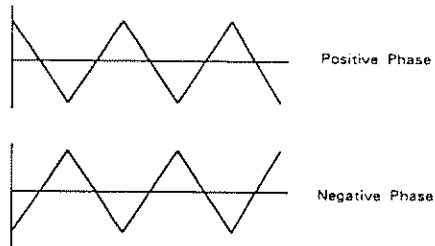

● **FFD**: LFO Depth **Ring**

This sets the depth of the PWM from 0 to 100. Higher values deepen the effect.

e. TVF

[Display 31]

```
I-11 U:3602 ( 50) 1111 Part-1 TUF
Freq 50 Reso 00 KF 1 BP 004 S1v1 00
```

● **Freq : Cutoff Frequency**

This sets the cutoff point of the TVF from 0 to 100. As you lower the value, higher frequencies are removed and the waveform gradually become an approximation of a sine wave, then the sound will finally fade out.

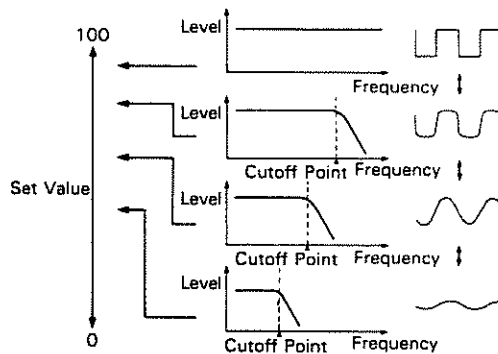

● **Reso : Resonance**

This boosts the cutoff point from 0 to 30. As you increase the value, specific harmonics are emphasized and the sound will become more unusual, more electronic in nature.

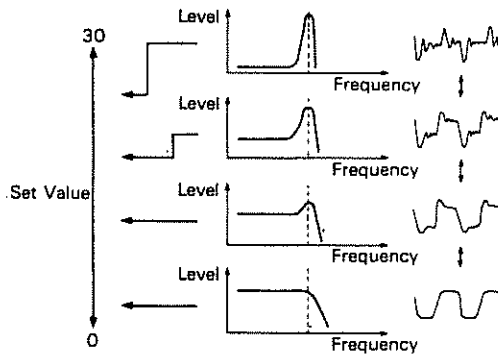

TONE PARAMETERS

●KF : Key Follow (Cutoff Point)

Key Follow can change the cutoff point depending on the key played.

Just like the Key follow of WG pitch, the value represents how many octaves change over 12 keys.

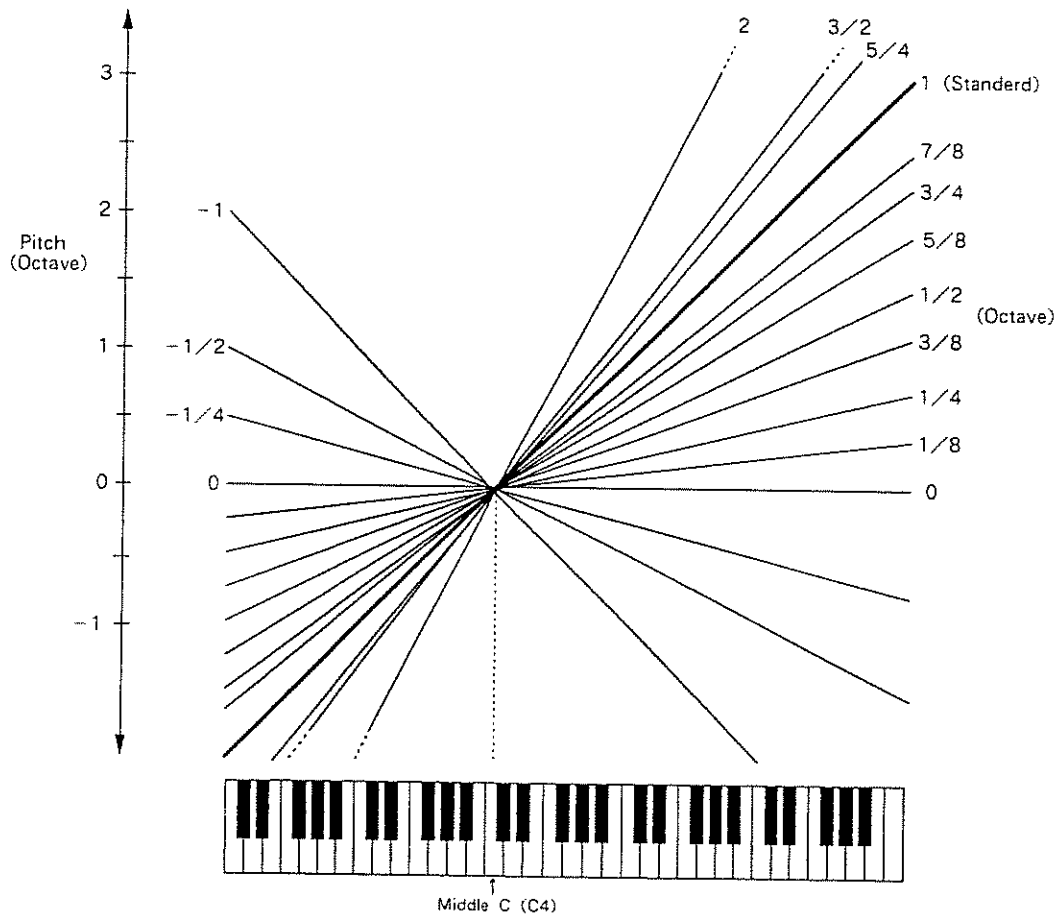

[Key Follow Adjustment]

You can add a further change (=bias level) to the Key Follow curve, and set the range (bias range) where the bias level is valid.

● **BP** : Bias Point/Bias Direction

The bias range is where the bias level is valid on the keyboard. It can be set with the bias point (where the bias range begins) and bias direction (< or >) from <A1 to <C7 and from >A1 to >C7 in semi-tone steps.

[e.g.]

>C4 : The bias level is only valid on the keyboard above the C4 key.

<C4 : The bias level is only valid on the keyboard below the C4 key.

● **BL** : Bias Level

The bias level can be set from -7 to +7. "+" values raise the curve, and "-" values lower the curve.

[Example]

When set to TVF Key Follow (Cutoff Point) "0" and Bias range ">C4"

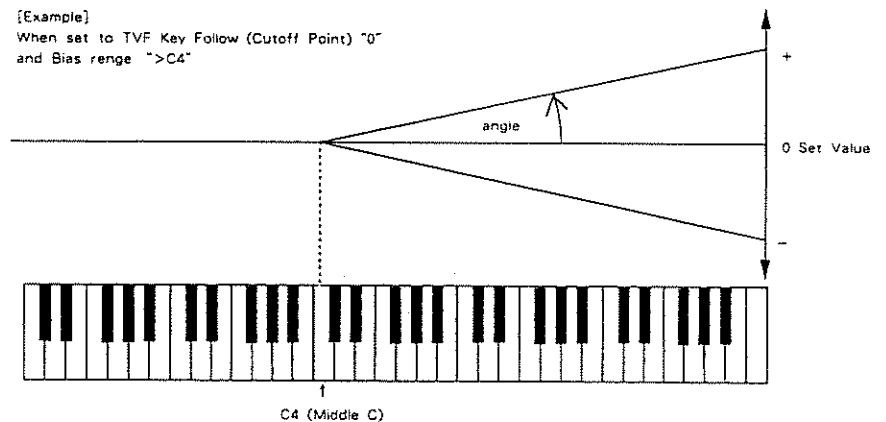

*The curve in the picture represents the Key Follow value with the bias level added.

tone parameters

f. TVF ENV

[Display 32]

```
I-11 U:St02 ( 50) 1111 Part-1 TVF ENV  
Dpth 50 Velo 00 DKF 00 TKF 00
```

● Dpth : ENV Depth

This sets the depth of the TVF ENV modulation that changes the TVF Cutoff Point. 0 to 100 are valid. Higher values deepen the effect.

● Velo : Velocity Range

This sets the sensitivity of the velocity that controls the depth of the TVF ENV. 0 to 100 are valid. At higher values, the effect is deeper by playing harder.

● DKF : Key Follow (Depth)

This can change the TVF ENV depth depending on the key played. 0 to 4 are valid, higher values change the depth more drastically.

● TKF : Key Follow (Time)

This can change the time of the TVF ENV depending on the key played. 0 to 4 are valid, higher values change the time more drastically.

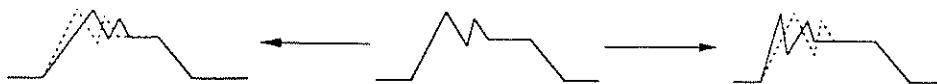

[Display 33]

```
I-11 U:SL01 < 50 > 1111 Part-1 TVF ENV
T1 50 T2 50 T3 50 T4 50 T5 50
```

[Display 34]

```
I-11 U:SL02 < 50 > 1111 Part-1 TVF ENV
L1 00 L2 00 L3 00 SusL 00 EndL 00
```

An envelope curve is determined by times and levels.

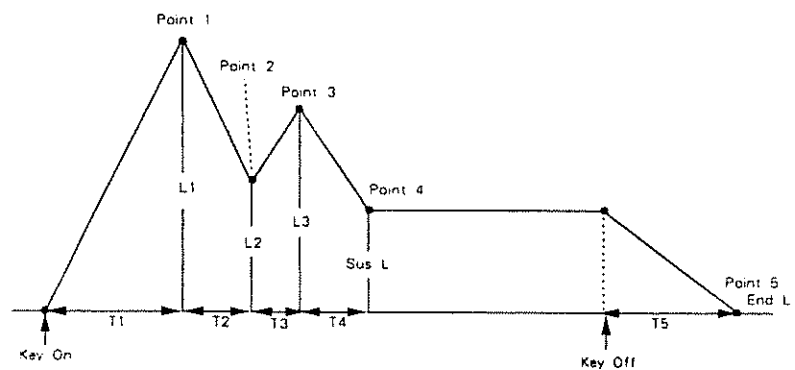

● **T1 : Time 1**

This sets the time needed to reach point 1 from the moment the key is pressed. 0 to 100 are valid.

● **L1 : Level 1**

This sets the level of point 1 from 0 to 100.

● **T2 : Time 2**

This sets the time needed to reach point 2 from point 1. 0 to 100 are valid.

● **L2 : Level 2**

This sets the level of point 2 from 0 to 100.

● **T3 : Time 3**

This sets the time needed to reach point 3 from point 2. 0 to 100 are valid.

● **L3 : Level 3**

This sets the level of point 3 from 0 to 100.

● TONE PARAMETERS

● T4 : Time 4

This sets the time needed to reach point 4 from point 3. 0 to 100 are valid.

● S4L : Sustain Level

This sets the level of point 4 from 0 to 100.

● T5 : Time 5

This sets the time needed to reach point 5 from the moment the key is released. 0 to 100 are valid.

● EndL : End Level

To lower the level after releasing the key, set this to 0, and to raise the level, set it to 100.

*The End Level is retained until you release and play the key again.

*If the Levels of two adjacent points are set to similar values, the time between these two points may prove to be shorter than what is actually set, or even zero.

g. TVF Modulation



[Display 35]

i-11	U:St02	< 50 >	1111	Part-1	TVF Mod
LFO +2	LFOD	50		After	00

● LFO : LFO Select **Ring** 

This selects the LFO that changes the cutoff point periodically (creating growl effects).

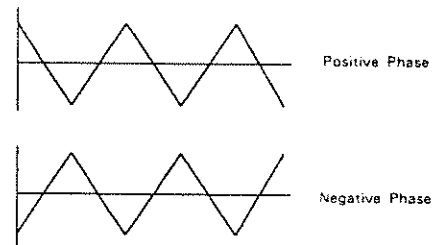
Display	LFO (Phase)
+1	LFO-1 (+)
-1	LFO-1 (-)
+2	LFO-2 (+)
-2	LFO-2 (-)
+3	LFO-3 (+)
-3	LFO-3 (-)

● LFOD : LFO Depth **Ring** 

This sets the depth of a growl effect from 0 to 100. Higher values deepen the effect.

● After : Aftertouch Range **Ring** 

This sets the sensitivity of the aftertouch that controls the cutoff point from -7 to +7. "-" values lower the cutoff point by stronger Aftertouch, and "+" values raise it.

h. TVA

[Display 36]

```
I-11 U:St02 < 50 > 1111 Part-1 TVA  
Levl100 Velo 00 BP >C4 B1v1 00
```

● **Levl**: Level **PCM**

This sets the volume of a Partial from 0 to 100.

*Higher values may cause sound distortion. If so, lower the value.

*Even when the Level is set to zero here, the sound may not be completely muted if the TVA ENV curve is high.

● **Velo**: Velocity Range **PCM**

This sets the sensitivity of the velocity that controls the volume of the sound. -50 to +50 are valid. "-" values lower the level by harder playing, and "+" values raise the level by harder playing.

[Volume Adjustment] PCM

You can change the overall volume of the keyboard (=bias level) from the set level, and set the range (bias range) where the bias level is valid.

● **BF : Bias Point/Bias Direction**

The bias range is where the bias level is valid on the keyboard. It can be set with the bias point (where the bias range begins) and bias direction (< or >) from <A1 to <C7 and from >A1 to >C7 in semi-tone steps.

[e.g.]

>C4 : The bias level is only valid on the keyboard above the C4 key.

<C4 : The bias level is only valid on the keyboard below the C4 key.

● **EL01 : Bias Level**

The curve (bias level) can be set from -12 to +0. Lower values make the curve steeper.

[Example]
When set to <C6.

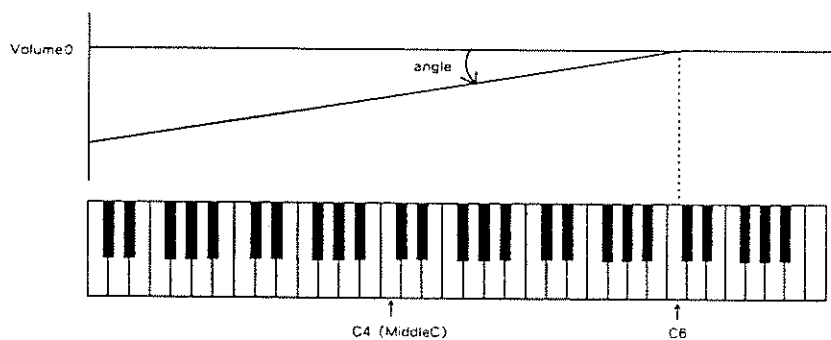

TONE PARAMETERS

i. TVA ENV

[Display 37]

```
I-11 U:St02 ( 50) 1111 Part-1 TVA ENV
T1 50 T2 40 T3 50 T4 50 T5 50
```

[Display 38]

```
I-11 U:St02 ( 50) 1111 Part-1 TVA ENV
L1 00 L2 00 L3 00 SusL 00 EndL 00
```

An envelope curve is determined by times and levels.

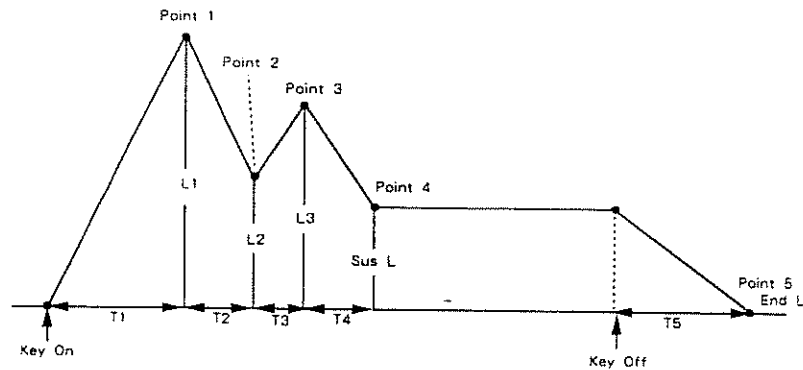

● **T1 : Time 1 PCM**

This sets the time needed to reach point 1 from the moment the key is pressed. 0 to 100 are valid.

● **L1 : Level 1 PCM**

This sets the level of point 1 from 0 to 100.

● **T2 : Time 2 PCM**

This sets the time needed to reach point 2 from point 1. 0 to 100 are valid.

● **L2 : Level 2 PCM**

This sets the level of point 2 from 0 to 100.

● **T3 : Time 3 PCM**

This sets the time needed to reach point 3 from point 2. 0 to 100 are valid.

● **L3 : Level 3 PCM**

This sets the level of point 3 from 0 to 100.

● **T4 : Time 4** **PCM**

This sets the time needed to reach point 4 from point 3. 0 to 100 are valid.

● **SUSL : Sustain Level** **PCM**

This sets the level of point 4 from 0 to 100.

● **L1 : Time 5** **PCM**

This sets the time needed to reach point 5 from the moment the key is released. 0 to 100 are valid.

● **EndL : End Level** **PCM**

To lower the level after releasing the key, set this to 0, and to raise the level, set it to 100. The End Level remains until the key is released and played again. That is, at a value of 100, the sound remains. However, the PCM Sound Generator's One-shot sounds do not remain even when set to 100.

*If the Levels of two adjacent points are set to similar values, the time between these two points may prove to be shorter than what is actually set, or even zero.

[Display 39]

```
I-11 U:St02 ( 50) 1111 Part-1 TVA ENV  
Velo 00 TKF 00
```

● **Velo** : Velocity Follow (Time 1) **PCM**

This sets the sensitivity of the velocity that controls the "Time 1" of the TVA ENV from 0 to 4. Increasing the sensitivity shortens "Time 1", by stronger playing.

● **TKF** : Key Follow (Time) **PCM**

This can change the time of the TVA ENV depending on the key played. 0 to 4 are valid. Higher values change the time more drastically.

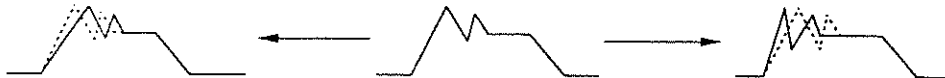
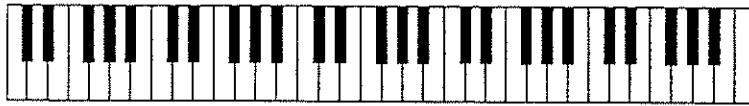

j. TVA Modulation



[画面 40]

L-11 U:St02 (50) 1111 Part-1 TVA Mod
LFO +3 LFOD 50 After 00

●LFO : LFO Select **Ring** 

This selects the LFO that changes the volume periodically (tremolo effects).

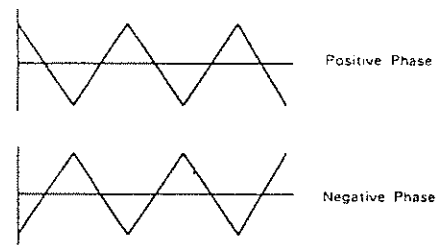
Display	LFO (Phase)
+1	LFO-1 (+)
-1	LFO-1 (-)
+2	LFO-2 (+)
-2	LFO-2 (-)
+3	LFO-3 (+)
-3	LFO-3 (-)

●LFOD : LFO Depth **Ring** 

This sets the depth of the tremolo effect from 0 to 100. Higher values deepen the effect.

●AFTLR : Aftertouch Range **Ring** 

This sets the sensitivity of the aftertouch that controls the volume from -7 to +7. "-" values lower the volume by stronger aftertouch, and "+" values increase the volume by stronger aftertouch.

7 WRITING

The edited data does not automatically rewrite the previous data, and therefore will be erased when a different Patch is selected or the unit is turned off. To retain the edited data, take the following writing procedure, either into the internal memory or onto a Memory Card.

[Selecting a Memory Location]

Writing a new Patch inevitably erases an existing Patch, so you may wish to listen to several Patches before deciding which Patch should be sacrificed for the new Patch. You can do it using the Compare Button.

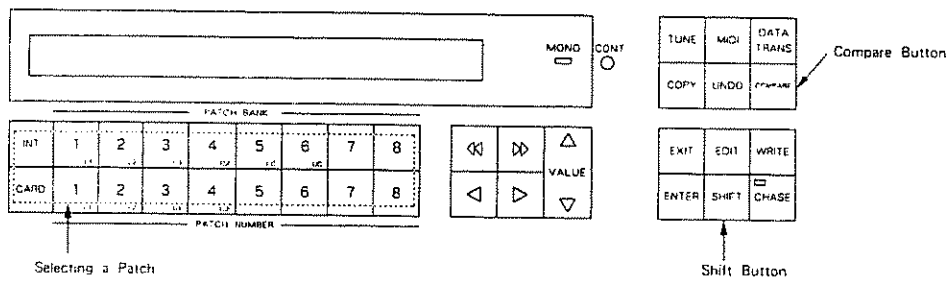

Step 1 Push the Compare Button.

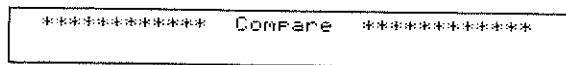

The edited data is retained at this stage.

Step 2 As you change Patches, listen to each sound, selecting the Patch number to be erased.

Step 3 While holding the Shift Button down, push the Compare Button. This recalls the edited data at the selected Patch number.

a. Writing into the Internal Memory

Before writing any data into the internal memory, you should set the Memory Protect of the D-550 to OFF. The Memory Protect is provided to protect data stored in memory from accidental erasure.

The D-550's Memory Protect can be turned OFF in two different ways depending on the writing procedure.

[Writing 1]

When you do not need to repeat the writing procedure, such as writing edited data, use the Write Button to turn the Protect OFF temporarily.

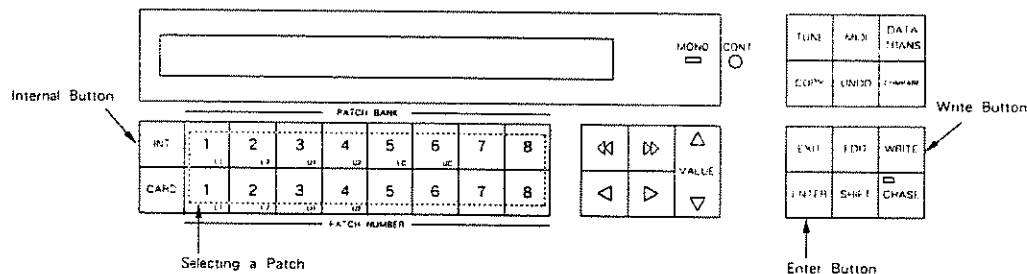

Step 1 Push the Write Button to enter the writing mode.

```
I-11 ***** Patch Write
      Write to [I-11] Sure? (Enter/Exit)
```

Destination Patch Number (flash)

Step 2 To write a Patch edited on a Memory Card, push the Internal Button, and to select a location Patch for the edited data, use the Patch Buttons.

Step 3 Push the Enter Button.

```
Int Memory Protected .
      Turn Protect off once? (Write/Exit)
```

WRITING

Step 4 Push the Write Button to turn the Protect OFF. The Display now shows the previous indication.

Step 5 Push the Enter Button.

When writing is completed, the Display responds as shown below for a few seconds, then returns to the Play mode indication. (The Memory Protect function is automatically turned back ON.)

Complete .

*If any other indication is shown in the Display, see "Error Messages Table" on page 116.

[Writing 2]

When you need to continue writing, such as when arranging the order of Patches, the method shown on page 93 (=turning Protect OFF temporarily) is not appropriate. The following is how to keep the Memory Protect in the OFF position :

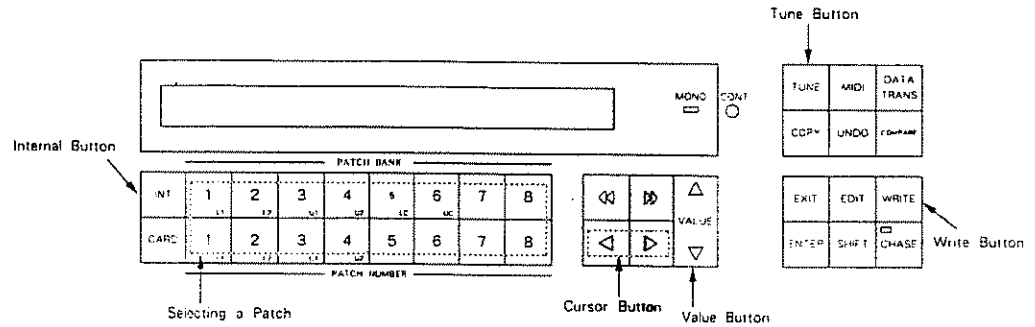

Step 1 Push the Tune Button.

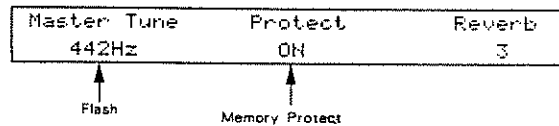

Step 2 Select "Protect" using the Cursor Buttons, and set it to OFF with the Value Button.

Step 3 Push the Write Button.

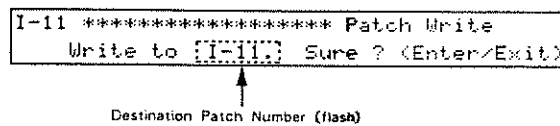

Step 4 To write a Patch edited on a Memory Card, push the Internal Button, and to select a location Patch for the edited data, use the Patch Buttons.

WRITING

Step 5 Push the Enter Button.

When writing is completed, the Display responds as shown below for a few seconds, then returns to the Play mode indication.

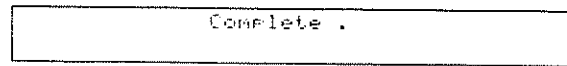

Complete .

*If any other indication is shown in the Display, see "Error Messages Table" on page 116.

Step 6 When writing is completed, turn the Memory Protect OFF by using a similar procedure, as described in Steps 1 and 2.

*Memory Protect is always ON when the unit is turned on.

b. Writing onto a Memory Card

When you write data onto a Memory Card (M-256D) for the first time, you should write the entire data in the internal memory beforehand, as explained in "Patch Transfer to a Memory Card" on page 103. If you try to write data onto a Memory Card without taking this procedure, the Display will show the following error message, and writing is not achieved. This error message is also shown when you are using a Memory Card that contains data other than that of a D-50 or D-550.

Illegal Card

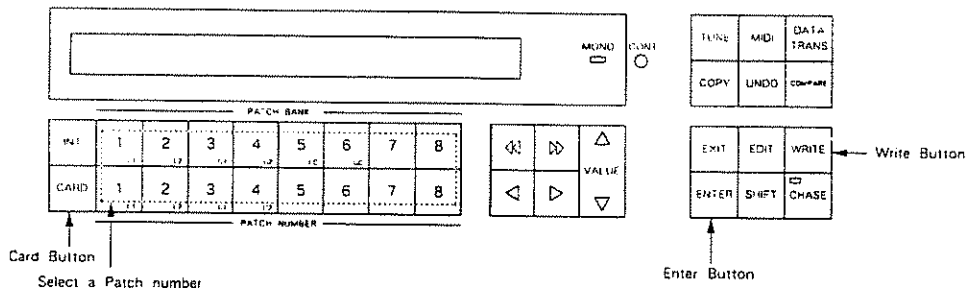

Step 1 Insert a Memory Card into the Card Slot.

Step 2 Set the position of the Protect Switch on the Memory Card to OFF.

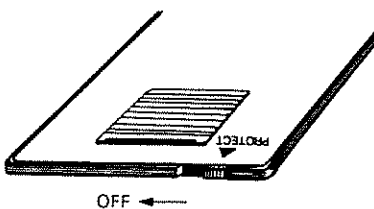

Step 3 Push the Write Button.

I-11 ***** Patch Write
Write to [I-11] Sure? (Enter/Exit)

Destination Patch Number (flash)

WRITING

Step 4 To write a Patch edited in the internal memory, push the Card Button, and to select a location Patch for the edited data, use the Patch Buttons.

Step 5 Push the Enter Button.

When writing is completed, the Display responds as shown below for a few seconds, then returns to the Play mode indication.

Complete .

*If any other indication is shown in the Display, see "Error Message Table" on page 116.

Step 6 When writing is completed, turn the Memory Protect back to the ON position.

c. Writing Procedure using the Programmer

When the PG-1000 programmer is being used, a Patch in the internal memory can be edited and rewritten by operating the programmer. This, however, does not apply to writing an edited Patch into a different Patch Number or Patches on a Memory Card.

[Procedure]

While holding the Partial Mute Button on the programmer, push the Manual Button twice.

When the writing is properly performed, the following indication will be shown in the Display for a few seconds.

Complete .

*If any other indication is shown in the Display, see "Error Messages Table" on page 116.

DATA TRANSFER

1. Patch Transfer	103
a. Patch Transfer to a Memory Card	103
b. Patch Transfer to the Internal Memory	105
2. Data Transfer via MIDI	107
3. Copying a Reverb Type	110
a. Copying Reverb from a Memory Card to the D-550	110
b. Copying from the D-550 to a Memory Card	111

DATA TRANSFER

The entire Patch data written in the D-550's memory can be saved on a Memory Card, and the data on the Memory Card can be loaded into the D-550's internal memory.

Also, using Roland MIDI Exclusive messages, the data can be transferred from one D-550 to another D-550, or to an MC-500.

Furthermore, Reverb Types programmed on the optional Sound Library Memory Card (ROM) can be copied to the D-550's internal memory, and the Reverb Types written in the D-550's memory can be copied to an optional Memory Card (M-256D).

[Available Reverb Types]

A Memory Card can store up to 16 different Reverb Types (17 to 32) at the same time, as well as 64 Patches. Available Reverb Types differ depending on which Patch is currently in use as shown below.

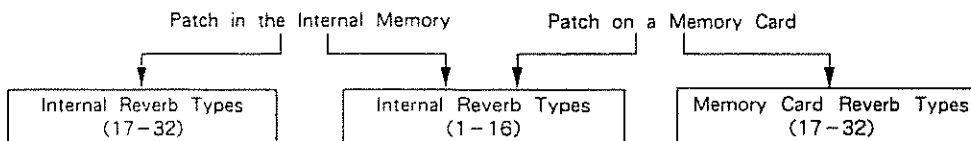

The optional Sound Library Memory Card (ROM) contains 16 different Reverb Types (17-32). When an edited Patch on a card is copied to the internal memory, the internal reverb type is used for the Patch, therefore, it may sound quite different from what you expect.

1. Patch Transfer

a. Patch Transfer to a Memory Card

All the 64 Patches stored in the D-550's internal memory can be saved onto the optional Memory Card (M-256D) at once. At the same time, Reverb Types 17 to 32 are saved.

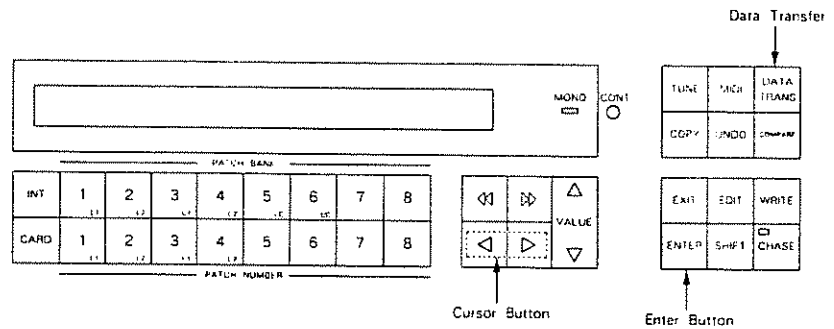

- Step 1 Insert the Memory Card into the Card slot.
- Step 2 Set the Protect Switch on the Memory Card to the OFF position.
- Step 3 Push the Data Transfer Button.

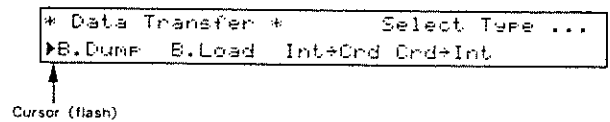

- Step 4 Using the Cursor Buttons, move the cursor to "Int+Card" position, then push the Enter Button.

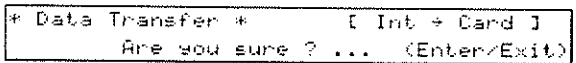

*When you write data onto a Memory Card for the first time, pushing the button will show the following indication for a few seconds, but you may carry out the procedure.

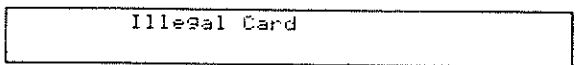

DATA TRANSFER

Step 5 Push the Enter Button.

When the data has been transferred properly, the Display changes to as below, then returns to the Play mode indication.

Complete .

*If any other indication is shown in the Display, see "Error Message Table" on page 116.

Step 6 Return the Protect Switch on the Memory Card to the ON position.

b. Patch Transfer to the Internal Memory

All the 64 Patches stored on the Memory Card can be loaded to the D-550's internal memory. At the same time, Reverb Types 17 to 32 are loaded.

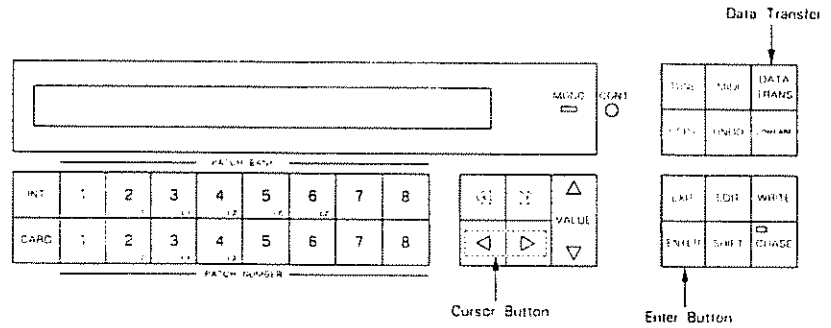

Step 1 Insert a Memory Card into the Card slot.

Step 2 Push the Data Transfer Button.

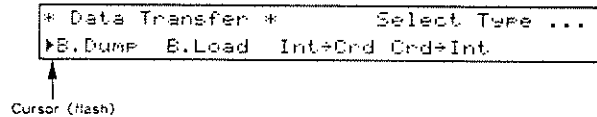

Step 3 Using the Cursor Button, select "Card-Int", then push the Enter Button.

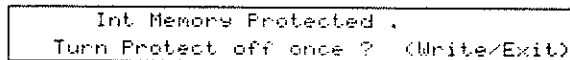

Step 4 Push the Write Button to turn the Memory Protect OFF temporarily. The Display responds as shown below.

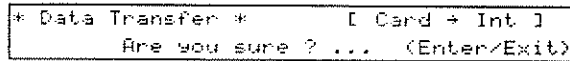

DATA TRANSFER

Step 5 Push the Enter Button.

When the data has been transferred properly, the Display changes as below, then returns to the Play mode indication (Memory Protect is automatically returned to ON.).

Complete .

*If any other indication is shown in the Display, see "Error Message Table" on page 116.

2. Data Transfer via MIDI

There are two methods of data transfer via MIDI: Handshake and One-way. Handshake allows you to verify whether the receiver is ready to receive the data, while one-way transmits the data without confirming the condition of the receiver.

*Data transfer can be done whether the Exclusive ON or OFF (page 35 "MIDI-3") is selected.

CONNECTION

• Handshake Connection

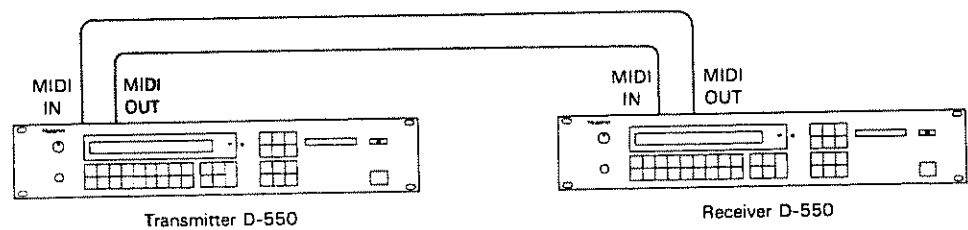

• One-way Connection

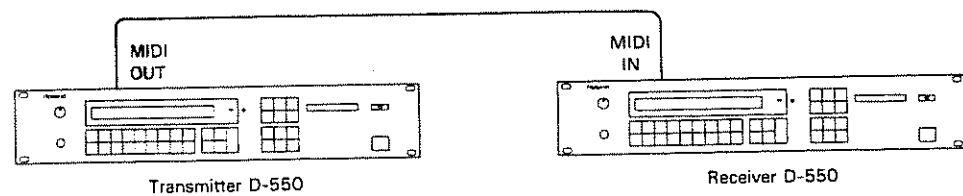

The example shown here is for data transfer between two D-550s. When using other device, refer to the owner's manual of that device.

DATA TRANSFER

- Step 1 Set the Basic Channel of the receiver to the same number as the transmitter's.
- Step 2 Set the Memory Protect of the receiver to OFF. (See page 95)
- Step 3 Push the Data Transfer Buttons on both the transmitter and receiver devices.

```
* Data Transfer *      Select Type ...  
->B.Dump  B.Load  Int+Crđ  Crđ+Int  
↑  
Cursor (Flash)
```

- Step 4 Set the receiver to the awaiting signal mode.

● Handshake Mode

- 1) Select "B.Load" with the Cursor Buttons.

```
* Data Transfer *      [ Bulk Load ]  
Are you sure ? ... (Enter/Exit)
```

- 2) Push the Enter Button.

```
* Data Transfer *      [ Bulk Load ]  
Waiting
```

● One-way Mode

- 1) Select "B.Load" with the Cursor Buttons, then push the Enter Button while holding the Data Transfer Button down.

```
* Data Transfer *      [ Bulk Load.0 ]  
Are you sure ? ... (Enter/Exit)
```

- 2) Push the Enter Button.

```
* Data Transfer *      [ Bulk Load.0 ]  
Waiting
```

Step 5 Set the transmitter to the signal-sending mode.

● **One-way Mode**

Assign "B.Dump" with the Enter Button.

```
* Data Transfer *      [ Bulk Dump ]
  Are you sure ? ... (Enter/Exit)
```

● **Handshake Mode**

While holding the Data Transfer Button down, assign "B.Dump" with the Enter Button.

```
* Data Transfer *      [ Bulk Dump.0 ]
  Are you sure ? ... (Enter/Exit)
```

Step 6 Push the Enter Button on the transmitter.

When data is transferred properly, the receiver's Display responds as shown below.

```
Complete .
```

*If the Display responds with any other indication, see "Error Message Table" on page 116.

Step 7 Push the Exit Buttons on both the transmitter and receiver to return to the Play mode.

Step 8 Return the Memory Protect of the receiver to ON.

3. COPYING A REVERB TYPE

On the optional Sound Library Memory Card (ROM), 32 reverb types (1 to 32) are programmed. 16 (17 to 32) of these reverb types can be copied to the D-550's internal memory. Also, the reverb types 17 to 32 written in the D-550's memory can be copied to the optional Memory Card (M-256D).

a. Copying from a Memory Card to the D-550

- Step 1 Connect the Sound Library Memory Card (ROM) to the Card slot.
- Step 2 Turn the Memory Protect of the D-550 to OFF.(See page 49.)
- Step 3 Call any Patch on the Memory Card.
- Step 4 Call the Output Mode Display (Display 8) in the Patch Factor section, and select one of the Reverb Types (17 to 32) to be copied.
- Step 5 While holding the Shift Key down, push the Write Button.

```
D-11 ***** Reverb Write
Write to [0-17] Sure ? (Enter/Exit)
```

↑
Destination Reverb Type Number (flash)

- Step 6 Push the Internal Button.
- Step 7 Push the center Selector Button.(The number of the destination Reverb Type flashes.)
- Step 8 Using the Value Button, select the destination Reverb Type (17 to 32) to be replaced with the one called from the Memory Card.
- Step 9 Hit the Enter Button.
- Step 10 Return the Memory Protect to ON.

b. Copying from the D-550 to a Memory Card

- Step 1 Connect the Memory Card (M-256D) to the Card slot.
- Step 2 Set the Protect Switch on the Memory Card to the OFF position.
- Step 3 Select any Patch in the D-550.
- Step 4 Call the Output Mode Display in the Patch Factor section, and select one of the Reverb Types (17 to 32) to be copied.
- Step 5 While holding the Shift Button down, push the Write Button.

```
i-11 ***** Reverb Write
Write to [1-17] Sure ? (Enter/Exit)
```

↑
Destination Reverb Type Number (flash)

- Step 6 Push the Card Button.
- Step 7 Using the Value Button, select the destination Reverb Type (17 to 32) to be replaced with the one called from the D-550.
- Step 8 Hit the Enter Button.
- Step 9 Return the Protect Switch to the ON position.

APPENDIX TABLES

1. MIDI FUNCTION TABLE

Display	MIDI Function	Value	Page
MIDI-1	MIDI CH	1 ... 16	34
	Control	Basic CH, Global CH, Mode Message Off	
	Separate Mode Receive CH	1 ... 16	
	Omni	Off, On	
MIDI-2	After Touch	Off, On	35
	Bender	Off, On	
	Modulation	Off, On	
	Volume	Off, On	
MIDI-3	Hold	Off, On	35
	Portamento	Off, On	
	Program Change	Off, On	
	Exclusive	Off, On, Patch Dump	
MIDI-4 Control Change	Chase	Off, 66 ... 95	36
	Tone Balance	Off, 0, 2, 3, 4, 8 ... 31	

2. PATCH FACTOR TABLE

Display	Factor	Value	Page
Play Mode	Key Mode	Whole, Dual, Split, Separate, Whole-S, Dual-S, Split-US, Split-LS, Separate-S	39
	Split Point	C2, C#2 ... C7	42
	Tone Balance	0 ... 100	29, 42
Control	Bender Range	0 ... 12	43
	After Touch (Pitch Bender)	-12 ... 0 ... +12	
	Hold Mode	U,L,UL	
Portamento	Portamento Mode	0 ... 100	44
	Portamento Time	U, L, UL	
	Portamento ON/OFF	Off, On	
	Separate ON/OFF	Off, On	
Output Mode	Output Mode	1 ... 4	45
	Reverb Type	1 ... 32 (17 ... 32 Change Type)	
	Reverb Balance	0 ... 100	
	Total Volume	0 ... 100	
Tone Tune	L-Tone Key Shift	-24 ... 0 ... +24	46
	U-Tone Key Shift	-24 ... 0 ... +24	
	L-Tone Fine Tune	-50 ... 0 ... +50	
	U-Tone Fine Tune	-50 ... 0 ... +50	
Chase	Chase Mode	UL, ULL, ULU	47
	Chase Level	0 ... 100	
	Chase Time	0 ... 100	
MIDI Channel	Transmit CH	Basic CH, 1 ... 16	48
	Separate Mode Receive CH	Off, 1 ... 16	
Patch Name	1 ... 18 (←) (→)	SPACE, A ... Z, a ... z, 1 ... 0, -	31

*ON/OFF of Chase can be selected using the Chase Button.

3. TONE PARAMETER TABLE

a. Common Parameters

Display	Parameter	Value	Page
Tone Name	1 ... 10 (←) (→)	SPACE, A ... Z, a ... z, 1 ... 0, -	31
Structure	Structure No.	1 ... 7	50, 63
Pitch ENV	Velocity Range	0 ... 2	64
	Key Follow (Time)	0 ... 4	
Pitch ENV Time	T1 ... T4	0 ... 50	65, 66
Pitch ENV Level	LO/L1/L2/ Sustain Level/End Level	-50 ... 0 ... +50	
Pitch Modulation	LFO Depth	0 ... 100	67
	Picth Lever Modulation	0 ... 100	
	Pitch After Touch Modulation	0 ... 100	
LFO-1	Waveform	Triangle, Sawtooth, Square, Random	68
	Rate	0 ... 100	
	Delay Time	0 ... 100	
	Sync.	Off, On, Key	
LFO-2	Waveform	Triangle, Sawtooth, Square, Random	68
	Rate	0 ... 100	
	Delay Time	0 ... 100	
	Sync.	Off, On	
LFO-3	Waveform	Triangle, Sawtooth, Square, Random	68
	Rate	0 ... 100	
	Delay Time	0 ... 100	
	Sync.	Off, On	
EQ	Lf	63, 75, 88, 105, 125, 150, 175, 210, 250, 300, 350, 420, 500, 600, 700, 840	69
	Lg	-12 ... 0 ... +12	
	Hf	250, 300, 350, 420, 500, 600, 700, 840, 1.0, 1.2, 1.4, 1.7, 2.0, 2.4, 2.8, 3.4, 4.0, 4.8, 5.7, 6.7, 8.0, 9.5	69, 70
	HQ	0.3, 0.5, 0.7, 1.0, 1.4, 2.0, 3.0, 4.2, 6.0	
	Hg	-12 ... 0 ... +12	
Chorus	Chorus Type	1 ... 8	71
	Chorus Rate	0 ... 100	
	Chorus Depth	0 ... 100	
	Chorus Balance	0 ... 100	

*Partial Mute (shown in all the Partial Parameter Displays.)

*Partial Balance (shown in all the Partial Parameter Displays.)

b. Partial Parameters

Display	PCM	Parameter	Value	Page
WG Pitch	○	Coarse	C1, C#1 ... C7	72
		Fine	-50 ... 0 ... +50	
		Key Follow	-1, -1/2, -1/4, 0, 1/8, 1/4, 3/8, 1/2, 5/8, 3/4, 7/8, 1, 5/4, 3/2, 2, sl, s2	72, 73
WG Modulation	○	LFO Mode	Off, (+), (-), A&L (After Touch & Lever)	74
		P-ENV Mode	Off, (+), (-)	
		Bender Mode	Off, Key Follow, Normal	
WG Waveform	×	Waveform	Square, Sawtooth	75
	○	PCM Wave No.	1 ... 100 (PCM Name)	75, 76
WG Pulse Width	×	Pulse Width	0 ... 100	77
		Velocity Range	-7 ... 0 ... +7	
		After Touch Range	R -7 ... 0 ... +7	78
		LFO Select	R +1, -1, +2, -2, +3, -3	
		LFO Depth	R 0 ... 100	
TVF	×	Cutoff Frequency	0 ... 100	79
		Resonance	0 ... 30	
		Key Follow	-1, -1/2, -1/4, 0, 1/8, 1/4, 3/8, 1/2, 5/8, 3/4, 7/8, 1, 5/4, 3/2, 2	80
		Bias Point/Bias Direction	<A1 ... <C7, >A1 ... >C7	81
		Bias Level	-7 ... 0 ... +7	
TVF ENV	×	Depth	0 ... 100	82
		Velocity Range	0 ... 100	
		Key Follow (Depth)	0 ... 4	
		Key Follow (Time)	0 ... 4	
TVF ENV Time	×	T1 ... T5	0 ... 100	83, 84
TVF ENV Level	×	L1/L2/L3/Sustain Level	0 ... 100	
		End Level	0, 100	
TVF Modulation	×	LFO Level	R +1, -1, +2, -2, +3, -3	85
		LFO Depth	R 0 ... 100	
		After Touch Range	R -7 ... 0 ... +7	
TVA	○	Level	0 ... 100	86
		Velocity Range	-50 ... 0 ... +50	
		Bias Point/Bias Direction	<A1 ... <C7, >A1 ... >C7	87
		Bias Level	-12 ... 0	
TVA ENV Time	○	T1 ... T5	0 ... 100	88, 89
TVA ENV Level	○	L1/L2/L3/Sustain Level	0 ... 100	
		End Level	0, 100	
TVA ENV	○	Velocity Follow (Time1)	0 ... 4	90
		Key Follow (Time)	0 ... 4	
TVA Modulation	×	LFO Select	R +1, -1, +2, -2, +3, -3	91
		LFO Depth	R 0 ... 100	
		After Touch Range	R -7 ... 0 ... +7	

R When Ring Modulator is used in a Structure, the settings of Partial 2 are exactly the same as Partial 1.

4. ERROR MESSAGE TABLE

Display	Description
<div style="border: 1px solid black; padding: 5px; text-align: center;">Check Internal Battery</div>	The back-up battery in the D-50 is low. Consult your local Roland Service Department.
<div style="border: 1px solid black; padding: 5px; text-align: center;">Check Card's Battery</div>	The back-up battery (CR2016) in the optional Memory Card (M-256D) is low. Replace it with a new one as shown in the instructions of the Memory Card.
<div style="border: 1px solid black; padding: 5px; text-align: center;">Int. Memory Protected . Turn Protect off once ?(Write/Exit)</div>	You have tried to write data into the D-550's memory with the Memory Protect on the D-550 set to ON. To set the Memory Protect to OFF temporarily, push the Write Button. If you wish to leave the writing mode, push the Exit Button.
<div style="border: 1px solid black; padding: 5px; text-align: center;">Card Memory Protected</div>	You have tried to write data onto the Memory Card with the Memory Protect Switch on the Memory Card in the ON position. Set it to OFF.
<div style="border: 1px solid black; padding: 5px; text-align: center;">Card Not Ready</div>	The Memory Card is not connected securely.
<div style="border: 1px solid black; padding: 5px; text-align: center;">Set key mode WHOLE or DUAL</div>	You pushed the Chase Button in a mode other than Whole or Dual Key Mode. Select the Whole or Dual Key Mode.
<div style="border: 1px solid black; padding: 5px; text-align: center;">Data Mismatch Cancel ...</div>	The destination Block you have selected differs from the source Block. Reselect the appropriate Block, and repeat Block Copy.
<div style="border: 1px solid black; padding: 5px; text-align: center;">MIDI Communication Error</div>	Data is not transferred properly. Push the Exit Button, check if the connections are correctly and securely made and repeat the transfer procedure.
<div style="border: 1px solid black; padding: 5px; text-align: center;">Verify Error</div>	Data is not properly loaded. If using a Memory Card, read the instructions of the Memory Card.
<div style="border: 1px solid black; padding: 5px; text-align: center;">Illegal Card</div>	This is shown when you are using a brand-new card or the card that contains the data for other than the D-550 or D-50.

D-550 **MIDI**
Implementation

Roland Exclusive Messages

1. Data Format for Exclusive Messages

Roland's MIDI implementation uses the following data format for all exclusive messages (type IV):

Byte	Description
F0H	Exclusive status
41H	Manufactures ID (Roland)
DEV	Device ID
MDL	Model ID
CMD	Command ID
[BODY]	Maindata
F7H	End of exclusive

MIDI status : F0H, F7H

An exclusive message must be flanked by a pair of status codes, starting with a Manufactures-ID immediately after F0H (MIDI version 1.0).

Manufactures-ID : 41H

The Manufactures-ID identifies the manufacturer of a MIDI instrument that triggers an exclusive message. Value 41H represents Roland's Manufactures-ID.

Device-ID : DEV

The Device-ID contains a unique value that identifies the individual device in the multiple implementation of MIDI instruments. It is usually set to 00H - 0FH, a value smaller by one than that of a basic channel, but value 00H - 1FH may be used for a device with multiple basic channels.

Model-ID : MDL

The Model-ID contains a value that uniquely identifies one model from another. Different models, however, may share an identical Model-ID if they handle similar data.

The Model-ID format may contain 00H in one or more places to provide an extended data field. The following are examples of valid Model-IDs, each representing a unique model:

01H
02H
03H
00H, 01H
00H, 02H
00H, 00H, 01H

Command-ID : CMD

The Command-ID indicates the function of an exclusive message. The Command-ID format may contain 00H in one or more places to provide an extended data field. The following are examples of valid Command-IDs, each representing a unique function:

01H
02H
03H
00H, 01H
00H, 02H
00H, 00H, 01H

Main data : BODY

This field contains a message to be exchanged across an interface. The exact data size and contents will vary with the Model-ID and Command-ID.

2. Address-mapped Data Transfer

Address mapping is a technique for transferring messages conforming to the data format given in Section 1. It assigns a series of memory-resident records (waveform and tone data, switch status, and parameters, for example) to specific locations in a machine-dependent address space, thereby allowing access to data residing at the address a message specifies.

Address mapped data transfer is therefore independent of models and data categories. This technique allows use of two different transfer procedures: one way transfer and handshake transfer.

One-way transfer procedure (See Section 3 for details.)

This procedure is suited for the transfer of a small amount of data. It sends out an exclusive message completely independent of a receiving device status.

Connection Diagram

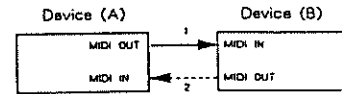

Connection at point 2 is essential for "Request data" procedures. (See Section 3.)

Handshake-transfer procedure (See Section 4 for details.)

This procedure initiates a predetermined transfer sequence (handshaking) across the interface before data transfer takes place. Handshaking ensures that reliability and transfer speed are high enough to handle a large amount of data.

Connection Diagram

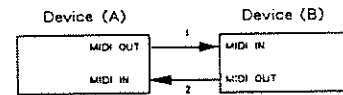

Connection at points 1 and 2 is essential.

Notes on the above two procedures

- * There are separate Command-IDs for different transfer procedures.
- * Devices A and B cannot exchange data unless they use the same transfer procedure, share identical Device-ID and Model ID, and are ready for communication.

3. One-way Transfer Procedure

This procedure sends out data all the way until it stops when the messages are so short that answerbacks need not be checked.

For long messages, however, the receiving device must acquire each message in time with the transfer sequence, which inserts intervals of at least 20 milliseconds in between.

Types of Messages

Message	Command ID
Request data 1	RQ1 (11H)
Data set 1	DT1 (12H)

Request data # 1 : RQ1 (11H)

This message is sent out when there is a need to acquire data from a device at the other end of the interface. It contains data for the address and size that specify designation and length, respectively, of data required.

On receiving an RQ1 message, the remote device checks its memory for the data address and size that satisfy the request.

If it finds them and is ready for communication, the device will transmit a "Data set 1 (DT1)" message, which contains the requested data. Otherwise, the device will send out nothing.

Byte	Description
F0H	Exclusive status
41H	Manufactures ID (Roland)
DEV	Device ID
MDL	Model ID
11H	Command ID
addr	Address MSR
⋮	⋮
⋮	1,5B
size	Size MSB
⋮	⋮
⋮	1,5B
sum	Check sum
F7H	End of exclusive

- *The size of the requested data does not indicate the number of bytes that will make up a DTI message, but represents the address fields where the requested data resides.
- *Some models are subject to limitations in data format used for a single transaction. Requested data, for example, may have a limit in length or must be divided into predetermined address fields before it is exchanged across the interface.
- *The same number of bytes comprises address and size data, which, however, vary with the Model-ID.
- *The error checking process uses a checksum that provides a bit pattern where the least significant 7 bits are zero when values for an address, size, and that checksum are summed.

Data set 1 : DTI (12H)

This message corresponds to the actual data transfer process. Because every byte in the data is assigned a unique address, a DTI message can convey the starting address of one or more data as well as a series of data formatted in an address - dependent order.

The MIDI standards inhibit non-real time messages from interrupting an exclusive one. This fact is inconvenient for the devices that support a "soft-through" mechanism. To maintain compatibility with such devices, Roland has limited the DTI to 256 bytes so that an excessively long message is sent out in separate segments.

Byte	Description
F0H	Exclusive
41H	Manufactures ID (Roland)
DEV	Device ID
MDL	Model ID
12H	Command ID
aaH	Address MSB
⋮	⋮
	LSB
ddH	Data
⋮	⋮
sum	Check sum
F7H	End of exclusive

- *A DTI message is capable of providing only the valid data among those specified by an RQI message.
- *Some models are subject to limitations in data format used for a single transaction. Requested data, for example, may have a limit in length or must be divided into predetermined address fields before it is exchanged across the interface.
- *The number of bytes comprising address data varies from one Model-ID to another.
- *The error checking process uses a checksum that provides a bit pattern where the least significant 7 bits are zero when values for an address, size, and that checksum are summed.

Example of Message Transactions

- Device A sending data to Device B
Transfer of a DTI message is all that takes place.

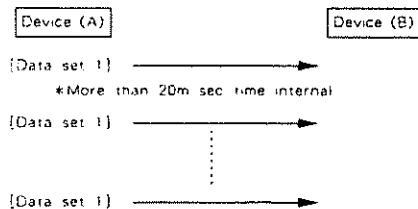

- Device B requesting data from Device A
Device B sends an RQI message to Device A. Checking the message, Device A sends a DTI message back to Device B.

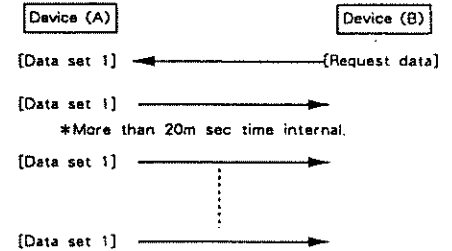

4. Handshake- Transfer Procedure

Handshaking is an interactive process where two devices exchange error checking signals before a message transaction takes place, thereby increasing data reliability. Unlike one-way transfer that inserts a pause between message transactions, handshake transfer allows much speedier transactions because data transfer starts once the receiving device returns a rudy signal.

When it comes to handling large amounts of data -- sampler waveforms and synthesizer tones over the entire range, for example -- across a MIDI interface, handshaking transfer is more efficient than one-way transfer.

Types of Messages

Message	Command ID
Want to send data	WSD (40H)
Request data	RQD (41H)
Data set	DAT (42H)
Acknowledge	ACK (43H)
End of data	EOD (45H)
Communication error	ERR (4EH)
Rejection	RJC (4FH)

Want to send data : WSD (40H)

This message is sent out when data must be sent to a device at the other end of the interface. It contains data for the address and size that specify designation and length, respectively, of the data to be sent.

On receiving a WSD message, the remote device checks its memory for the specified data address and size which will satisfy the request. If it finds them and is ready for communication, the device will return an "Acknowledge (ACK)" message. Otherwise, it will return a "Rejection (RJC)" message.

Byte	Description
F0H	Exclusive status
41H	Manufactures ID (Roland)
DEV	Device ID
MDL	Model ID
40H	Command ID
aaH	Address MSB
⋮	⋮
	LSB
ssH	Size MSB
⋮	⋮
	LSB
sum	Check sum
F7H	End of exclusive

- *The size of the data to be sent does not indicate the number of bytes that make up a "Data set (DAT)" message, but represents the address fields where the data should reside.
- *Some models are subject to limitations in data format used for a single transaction. Requested data, for example, may have a limit in length or must be divided into predetermined address fields before it is exchanged across the interface.
- *The same number of bytes comprises address and size data, which, however, vary with the Model-ID.
- *The error checking process uses a checksum that provides a bit pattern where the least significant 7 bits are zero when values for an address, size, and that checksum are summed.

Request data : RQD (41H)

This message is sent out when there is a need to acquire data from a device at the other end of the interface. It contains data for the address and size that specify designation and length, respectively, of data required.

On receiving an RQD message, the remote device checks its memory for the data address and size which satisfy the request. If it finds them and is ready for communication, the device will transmit a "Data set (DAT)" message, which contains the requested data. Otherwise, it will return a "Rejection (RJC)" message.

Byte	Description
F0H	Exclusive status
41H	Manufactures ID (Roland)
DEV	Device ID
MDL	Model ID
41H	Command ID
aaH	Address MSB
⋮	⋮
	LSB
ssH	Size MSB
⋮	⋮
	LSB
sum	Check sum
F7H	End of exclusive

- *The size of the requested data does not indicate the number of bytes, that make up a "Data set (DAT)" message, but represents the address fields where the requested data resides.
- *Some models are subject to limitations in data format used for a single transaction. Requested data, for example, may have a limit in length or must be divided into predetermined address fields before it is exchanged across the interface.
- *The same number of bytes comprises address and size data, which, however, vary with the Model-ID.
- *The error checking process uses a checksum that provides a bit pattern where the least significant 7 bits are zero when values for an address, size, and that checksum are summed.

Data set : DAT (42H)

This message corresponds to the actual data transfer process. Because every byte in the data is assigned a unique address, the message can convey the starting address of one or more data as well as a series of data formatted in an address-dependent order.

Although the MIDI standards inhibit non-real time messages from interrupting an exclusive one, some devices support a "soft-through" mechanism for such interrupts. To maintain compatibility with such devices, Roland has limited the DAT to 256bytes so that an excessively long message is sent out in separate segments.

Byte	Description
F0H	Exclusive status
41H	Manufactures ID (Roland)
DEV	Device ID
MDL	Model ID
42H	Command ID
aaH	Address MSB
⋮	⋮
	LSB
ddH	Data
⋮	⋮
sum	Check sum
F7H	End of exclusive

*A DAT message is capable of providing only the valid data among those specified by an RQD or WSD message.

- *Some models are subject to limitations in data format used for a single transaction. Requested data, for example, may have a limit in length or must be divided into predetermined address fields before it is exchanged across the interface.
- *The number of bytes comprising address data varies from one model ID to another.
- *The error checking process uses a checksum that provides a bit pattern where the least significant 7 bits are zero when values for an address, size, and that checksum are summed.

Acknowledge : ACK (43H)

This message is sent out when no error was detected on reception of a WSD, DAT, "End of data (EOD)", or some other message and a requested setup or action is complete. Unless it receives an ACK message, the device at the other end will not proceed to the next operation.

Byte	Description
F0H	Exclusive status
41H	Manufactures ID (Roland)
DEV	Device ID
MDL	Model ID
43H	Command ID
F7H	End of exclusive

End of data : EOD (45H)

This message is sent out to inform a remote device of the end of a message. Communication, however, will not come to an end unless the remote device returns an ACK message even though an EOD message was transmitted.

Byte	Description
F0H	Exclusive status
41H	Manufactures ID (Roland)
DEV	Device ID
MDL	Model ID
45H	Command ID
F7H	End of exclusive

Communications error : ERR (4EH)

This message warns the remote device of a communications fault encountered during message transmission due, for example, to a checksum error. An ERR message may be replaced with a "Rejection (RJC)" one, which terminates the current message transaction in midstream.

When it receives an ERR message, the sending device may either attempt to send out the last message a second time or terminate communication by sending out an RJC message.

Byte	Description
F0H	Exclusive status
41H	Manufactures ID (Roland)
DEV	Device ID
MDL	Model ID
4EH	Command ID
F7H	End of exclusive

Rejection : RJC (4FH)

This message is sent out when there is a need to terminate communication by overriding the current message. An RJC message will be triggered when :

- a WSD or RQI message has specified an illegal data address or size,
- the device is not ready for communication,
- an illegal number of addresses or data has been detected,
- data transfer has been terminated by an operator,
- a communications error has occurred.

An ERR message may be sent out by a device on either side of the interface. Communication must be terminated immediately when either side triggers an ERR message.

Byte	Description
F0H	Exclusive status
41H	Manufactures ID (Roland)
DEV	Device ID
MDL	Model ID
4FH	Command ID
F7H	End of exclusive

Example of Message Transactions

● Data transfer from device (A) to device (B).

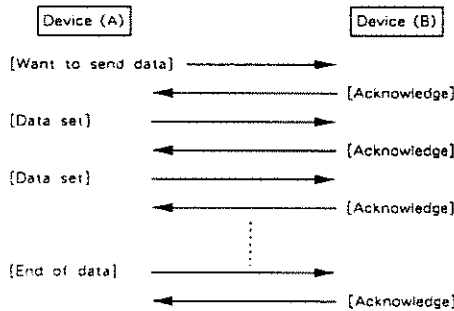

● Device (A) requests and receives data from device (B).

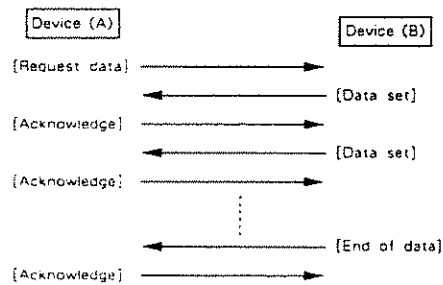

● Error occurs while device (A) is receiving data from device (B).

1) Data transfer from device (A) to device (B).

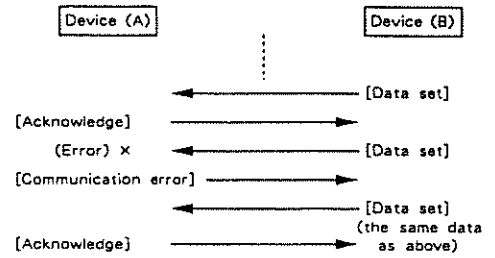

2) Device (B) rejects the data re-transmitted, and quits data transfer.

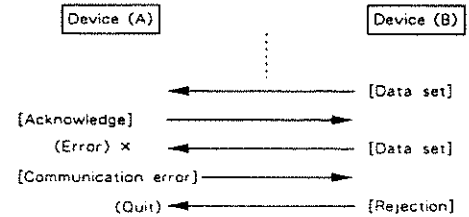

3) Device (A) immediately quits data transfer

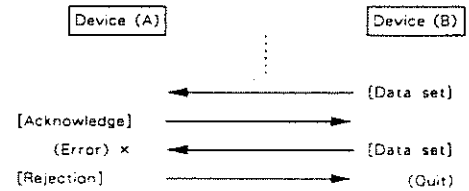

1. TRANSMITTED DATA

■ System Exclusive

Exclusive

Status
FOH : System Exclusive
F7H : EOX (End Of Exclusive)

Transmitted in the following two cases,
1) Operating Bulk-Dump
2) If Exclu of MIDI function is "P-Dump", this unit transmits all parameters in the patch when PATCH GROUP, PATCH BANK or PATCH NUMBER button is pressed.

Refer to Section 4, to see details.

2. RECOGNIZED RECEIVE DATA (MAIN CHANNEL)

■ Note Event

Note Off

<u>Status</u> 8nH 9nH	<u>Second</u> kkH kkH	<u>Third</u> vvH vvH
kk=Note Number vv=Velocity n= MIDI Channel	00H-7FH (00-127) ignored 0H-FH (1-16)	

Note On

<u>Status</u> 9nH	<u>Second</u> kkH	<u>Third</u> vvH
vv=Velocity	01H-7FH (1-127)	

Note numbers outside of the range 12-108 are transposed to the nearest octave inside this range.

■ Control Change

Modulation Depth (receive/ignore selectable)

<u>Status</u> BnH	<u>Second</u> 01H	<u>Third</u> vvH
vv=Modulation Depth	0H-7FH (0-127)	

Portamento Time (receive/ignore selection)

<u>Status</u> BnH	<u>Second</u> 05H	<u>Third</u> vvH
vv=Portamento Time	0H-7FH (0-127)	

Data Entry MSB

<u>Status</u> BnH	<u>Second</u> 0EH	<u>Third</u> vvH
MSB of value that corresponds to the parameter specified by RPC. (Refer to RPC MSB)		

Main Volume (receive/ignore selectable)

<u>Status</u> BnH	<u>Second</u> 07H	<u>Third</u> vvH
vv=Volume Value	0H-7FH (0-127)	

The volume of the sound can be controlled by main volume message within the level adjusted by the panel volume knob.

Tone Balance (receive/ignore selectable)

<u>Status</u> BnH	<u>Second</u> cEH	<u>Third</u> vvH
cc (Control Change Number)	0H,2H-4H,8H-1FH (0,2,4,8-31)	
vv=Tone Balance Value	0H-7FH (0-127)	

Control change number for Tone Balance can be selected from 0, 2, 4, 8-31 in the MIDI Function.

Data Entry LSB

<u>Status</u> BnH	<u>Second</u> 2EH	<u>Third</u> vvH
LSB of value that corresponds to the parameter specified by RPC. (Refer to RPC MSB)		

Hold1 (receive/ignore selectable)

<u>Status</u> BnH	<u>Second</u> 40H	<u>Third</u> vvH
vv=00H-3FH : Off vv=40H-7FH : On		

Portamento (receive/ignore selectable)

<u>Status</u> BnH	<u>Second</u> 41H	<u>Third</u> vvH
vv=00H-3FH : Off vv=40H-7FH : On		

Chase

<u>Status</u> BnH	<u>Second</u> ccH	<u>Third</u> vvH
cc=42H-5FH (66-95) : (Control Change Number) vv=00H-3FH : Off vv=40H-7FH : On		

Control change number for Chase can be selected from 66-95 in the MIDI Function.

RPC LSB

<u>Status</u> BnH	<u>Second</u> 64H	<u>Third</u> vvH
vv=LSB of parameter number controlled by RPC (Refer to RPC MSB)		

RPC MSB

<u>Status</u> BnH	<u>Second</u> 65H	<u>Third</u> vvH
vv=MSB of parameter number controlled by RPC		

Using MIDI RPC, parameters can be changed by control change messages. RPC MSB and RPC LSB specify the parameter to be controlled, and Data Entry MSB and Data Entry LSB show the parameter value.

RPC MSB	RPC LSB	Data Entry MSB	Data Entry LSB	Description
00H	00H	vvH	ignored	Bender Range vv=0-12 (semitone step, max. one octave)
00H	01H	vvH	vvH	Fine Tuning
		00H	00H	-50 cent
		20H	00H	-50 cent
		40H	00H	0 cent
		60H	00H	+50 cent
		80H	00H	+50 cent

■ Program Change

Patch Change (receive/ignore selectable)

<u>Status</u> CnH	<u>Second</u> ppH
pp=Patch Number (0-127)	

Recognized in play mode only.
Internal Memory or Memory Card is selected according to the Patch number

0-63: Internal Memory Group
64-127: Memory Card Group

■ Channel After Touch

After Touch (receive/ignore selectable)

<u>Status</u> BnH	<u>Second</u> vvH
vv=After Touch Value 0-7FH (0-127)	

■ Pitch Bender Change

Pitch Bender (receive/ignore selectable)

<u>Status</u> BnH	<u>Second</u> vvH	<u>Third</u> vvH
vv=vv=Pitch Bender Change Value		

Mode Message

All Note Off

Status	Second	Third
0nH	7BH	00H

When ALL NOTES OFF is recognized, all the notes which have been turned ON by MIDI IN note ON messages are turned OFF.

OMNI OFF

Status	Second	Third
BnH	7CH	00H

OMNI ON

Status	Second	Third
BnH	7DH	00H

MONO

Status	Second	Third
BnH	7EH	nmH

nm=MONO Channel Range 0-10H (0-10)

Channel range is recognized as follows.

mm	Channel Range
0	8
1-8	1-8
9-16	8
17-127	ignored

In MONO mode, each message is recognized on the channel shown below.

Message	Control in MIDI function	
	B.CH	G.CH
Note on/off	individual	individual
Control Change	basic	global
Mode Message	basic	basic
Program Change	basic	global
After Touch	basic	global
Pitch Bender Change	individual	individual
Exclusive	basic	basic

*Global channel is equal to "basic channel-1".
And if basic channel is 1, global channel is 16.

POLY

Status	Second	Third
0nH	7FH	00H

These Mode Messages (2nd byte = 129-127) are also recognized as ALL NOTES OFF.

Exclusive

Status	Second	Third
E0H		: System Exclusive
F7H		: EOX (End Of Exclusive)

Exclusive message can change either each parameter individually or all parameters, of a patch or tone. (receive ignore selectable)
Also used for DULC LOAD operation.
Refer to Section 4.

Active Sensing

Status	Second	Third
FEH		: Active Sensing

3. RECOGNIZED RECEIVE DATA (SEPARATE CHANNEL)

Note Event

Note Off

Status	Second	Third
8nH	kkH	vvH
9nH	kkH	00H

kk=Note Number 00H-7FH (00-127)
vv=Velocity ignored
n=MIDI Channel 0H-FH (1-16)

Note On

Status	Second	Third
9nH	kkH	vvH

vv=Velocity 0H-7FH (1-127)

Note numbers outside of the range 12-108 are transposed to the nearest octave inside this range.

Control Change

Modulation (receive/ignore selectable)

Status	Second	Third
0nH	01H	vvH

vv=Modulation Depth 0H-7FH (0-127)

Portamento (receive/ignore selectable)

Status	Second	Third
BnH	05H	vvH

vv=Portamento Time 0H-7FH (0-127)

Data Entry MSB

Status	Second	Third
BnH	06H	vvH

vv=MSB of value that corresponds to the parameter specified by RPC. (Refer to RPC MSB)

Data Entry LSB

Status	Second	Third
BnH	26H	vvH

vv=LSB of value that corresponds to the parameter specified by RPC. (Refer to RPC MSB)

Hold 1 (receive/ignore selectable)

Status	Second	Third
0nH	36H	vvH

vv=00H:OFF (0)
vv=00H:7FH:On

Portamento (receive/ignore selectable)

Status	Second	Third
BnH	3FH	vvH

vv=00H:OFF (0)
vv=00H:7FH:On

RPC LSB

Status	Second	Third
BnH	73H	vvH

vv=LSB of parameter number controlled by RPC (Refer to RPC MSB)

RPC MSB

Status	Second	Third
BnH	65H	vvH

vv=MSB of parameter number controlled by RPC.

Using MIDI RPC, parameters can be changed by control change message. RPC MSB and RPC LSB specify the parameter to be controlled, and Data Entry MSB and Data Entry LSB show the parameter value.

RPC MSB	RPC LSB	Data Entry MSB	Data Entry LSB	Description
00H	00H	vvH	ignored	Bender Range vv=0-127 (bender step: max. one octave)

25H	0vvv vvvv	TVA BIAS POINT	(-50-+50) 0-63,64-127 <A1-<C7, >A1->C7			6: 175 7: 210 8: 250 9: 300 10: 350 11: 420 12: 500 13: 600 14: 700 15: 840	
26H	0vvv vvvv	TVA BIAS LEVEL	0-12 (-12-0)			(-12-+12)	
27H	0vvv vvvv	TVA ENV TIME 1	0-100			0: 250 1: 300 2: 350 3: 420 4: 500 5: 600 6: 700 7: 840	
28H	0vvv vvvv	TVA ENV TIME 2	0-100			8: 1.0 9: 1.2 10: 1.4 11: 1.7 12: 2.0 13: 2.4 14: 2.8 15: 3.4	
29H	0vvv vvvv	TVA ENV TIME 3	0-100			16: 4.0 17: 4.8 18: 5.7 19: 6.7 20: 8.0 21: 9.5	
2AH	0vvv vvvv	TVA ENV TIME 4	0-100			0: 0.3 1: 0.5 2: 0.7 3: 1.0 4: 1.4 5: 2.0 6: 3.0 7: 4.2 8: 6.0	
2BH	0vvv vvvv	TVA ENV TIME 5	0-100	26H	0vvv vvvv	LOW EQ GAIN	0-24
2CH	0vvv vvvv	TVA ENV LEVEL 1	0-100				
2DH	0vvv vvvv	TVA ENV LEVEL 2	0-100				
2EH	0vvv vvvv	TVA ENV LEVEL 3	0-100	27H	0vvv vvvv	LOW EQ FREQUENCY	0: 250 1: 300 2: 350 3: 420 4: 500 5: 600 6: 700 7: 840
2FH	0vvv vvvv	TVA ENV SUSTAIN LEVEL	0-100				
30H	0vvv vvvv	TVA ENV END LEVEL	0: 0 1: 100				
31H	0vvv vvvv	TVA ENV VELOCITY FOLLOW	0-4				
32H	0vvv vvvv	TVA ENV TIME KEYFOLLOW	0-4				
33H	0vvv vvvv	TVA MOD LFO SELECT	0: +LFO1 1: -LFO1 2: +LFO2 3: -LFO2 4: +LFO3 5: -LFO3				
34H	0vvv vvvv	TVA MOD LFO DEPTH	0-100				
35H	0vvv vvvv	TVA MOD AFTERTOUCH RANGE	0-14 (-7-+7)				
36H	0vvv vvvv	EXTENSION	0-127				
37H	0vvv vvvv	EXTENSION	0-127				
38H	0vvv vvvv	EXTENSION	0-127				
39H	0vvv vvvv	EXTENSION	0-127				
3AH	0vvv vvvv	EXTENSION	0-127				
3BH	0vvv vvvv	EXTENSION	0-127				
3CH	0vvv vvvv	EXTENSION	0-127				
3DH	0vvv vvvv	EXTENSION	0-127	28H	0vvv vvvv	HIGH EQ Q	0: 0.3 1: 0.5 2: 0.7 3: 1.0 4: 1.4 5: 2.0 6: 3.0 7: 4.2 8: 6.0
3EH	0vvv vvvv	EXTENSION	0-127				
3FH	0vvv vvvv	EXTENSION	0-127				

4.3 Common Parameter

Offset Address	Description	
00H	0vvv vvvv	TONE NAME 1 (' 'A'-'Z','a'-'z','1'-'9','0','-')
09H	0vvv vvvv	TONE NAME 10
0AH	0vvv vvvv	STRUCTURE NO.
0BH	0vvv vvvv	P-ENV VELOCITY RANGE
0CH	0vvv vvvv	P-ENV TIME KEYFOLLOW
0DH	0vvv vvvv	P-ENV TIME 1
0EH	0vvv vvvv	P-ENV TIME 2
0FH	0vvv vvvv	P-ENV TIME 3
10H	0vvv vvvv	P-ENV TIME 4
11H	0vvv vvvv	P-ENV LEVEL 0 (-50 -+50)
12H	0vvv vvvv	P-ENV LEVEL 1 (-50 -+50)
13H	0vvv vvvv	P-ENV LEVEL 2 (-50 -+50)
14H	0vvv vvvv	P-ENV SUSTAIN LEVEL (-50 -+50)
15H	0vvv vvvv	P-ENV END LEVEL (-50 -+50)
16H	0vvv vvvv	P-MOD LFO DEPTH
17H	0vvv vvvv	P-MOD LEVER
18H	0vvv vvvv	P-MOD AFTERTOUCH
19H	0vvv vvvv	LFO-1 WAVE FORM 0: TRI 1: SAW 2: SQU 3: RND
1A	0vvv vvvv	LFO-1 RATE
1B	0vvv vvvv	LFO-1 DELAY TIME
1C	0vvv vvvv	LFO-1 SYNC 0: OFF 1: ON
1D	0vvv vvvv	LFO-2 WAVE FORM 0: TRI 1: SAW 2: SQU 3: RND
1E	0vvv vvvv	LFO-2 RATE
1F	0vvv vvvv	LFO-2 DELAY TIME
20H	0vvv vvvv	LFO-2 SYNC 0: OFF 1: ON
21H	0vvv vvvv	LFO-3 WAVE FORM 0: TRI 1: SAW 2: SQU 3: RND
22H	0vvv vvvv	LFO-3 RATE
23H	0vvv vvvv	LFO-3 DELAY TIME
24H	0vvv vvvv	LFO-3 SYNC 0: OFF 1: ON
25H	0vvv vvvv	LOW EQ FREQUENCY 0: 63 1: 75 2: 88 3: 105 4: 125 5: 150

29H	0vvv vvvv	HIGH EQ GAIN	0-24 (-12-+12)
2AH	0vvv vvvv	CHORUS TYPE	0-7 (1-8)
2BH	0vvv vvvv	CHORUS RATE	0-100
2CH	0vvv vvvv	CHORUS DEPTH	0-100
2DH	0vvv vvvv	CHORUS BALANCE	0-100
2EH	0vvv vvvv	PARTIAL MUTE	0: 0.0 1: 0.1 2: 1.0 3: 1.1
2FH	0vvv vvvv	PARTIAL BALANCE	0-100
30H	0vvv vvvv	EXTENSION	0-127
31H	0vvv vvvv	EXTENSION	0-127
32H	0vvv vvvv	EXTENSION	0-127
33H	0vvv vvvv	EXTENSION	0-127
34H	0vvv vvvv	EXTENSION	0-127
35H	0vvv vvvv	EXTENSION	0-127
36H	0vvv vvvv	EXTENSION	0-127
37H	0vvv vvvv	EXTENSION	0-127
38H	0vvv vvvv	EXTENSION	0-127
39H	0vvv vvvv	EXTENSION	0-127
3AH	0vvv vvvv	EXTENSION	0-127
3BH	0vvv vvvv	EXTENSION	0-127
3CH	0vvv vvvv	EXTENSION	0-127
3DH	0vvv vvvv	EXTENSION	0-127
3EH	0vvv vvvv	EXTENSION	0-127
3FH	0vvv vvvv	EXTENSION	0-127

4.4 Patch Parameter

Offset Address	Description	
00H	0vvv vvvv	PATCH NAME 1 (' 'A'-'Z','a'-'z','1'-'9','0','-')
11H	0vvv vvvv	PATCH NAME 18
12H	0vvv vvvv	KEY MODE 0: WHOLE 1: DUAL 2: SPLIT 3: SEPARATE 4: WHOLE-S 5: DUAL-S 6: SPLIT-US 7: SPLIT-LS 8: SEPARATE-S
13H	0vvv vvvv	SPLIT POINT (C2,C#2-C7)
14H	0vvv vvvv	PORTAMENTO 0: UPPER 1: LOWER 2: UPPER-LOWER
15H	0vvv vvvv	HOLD MODE 0: UPPER 1: LOWER 2: UPPER

			LOWER
16H	0vvv vvvv	UPPER TONE KEY SHIFT	0-48 (-24-+24)
17H	0vvv vvvv	LOWER TONE KEY SHIFT	0-48 (-24-+24)
18H	0vvv vvvv	UPPER TONE FINE TUNE	0-100 (-50-+50)
19H	0vvv vvvv	LOWER TONE FINE TUNE	0-100 (-50-+50)
1AH	0vvv vvvv	BENDER RANGE	0-12
1BH	0vvv vvvv	AFTERTOUCH BEND RANGE	0-24 (-12-+12)
1CH	0vvv vvvv	PORTAMENTO TIME	0-100
1DH	0vvv vvvv	OUTPUT MODE	0-3 (1-4)
1EH	0vvv vvvv	REVERB TYPE	0-31 (1-32)
1FH	0vvv vvvv	REVERB BALANCE	0-100
20H	0vvv vvvv	TOTAL VOLUME	0-100
21H	0vvv vvvv	tone BALANCE	0-100
22H	0vvv vvvv	CHASE MODE	0: UL 1: ULL 2: ULU 0-100
23H	0vvv vvvv	CHASE LEVEL	0-100
24H	0vvv vvvv	CHASE TIME	0-100
25H	0vvv vvvv	MIDI TRANSMIT CHANNEL	0: BASIC CH. 1-16: CH. 1-16
26H	0vvv vvvv	MIDI SEPARATE RECEIVE CHANNEL	0: OFF 1-16: CH.1-16
27H	0vvv vvvv	MIDI TRANSMIT PROGRAM CHANGE	0: OFF 1-100: NO.1-100
28H	0vvv vvvv	CHASE SWITCH	0: OFF 1: ON
29H	0vvv vvvv	MAIN CH PORTAMENTO SWITCH	0: OFF 1: ON
3AH	0vvv vvvv	SEP CH PORTAMENTO SWITCH	0: OFF 1: ON
2BH	0vvv vvvv	EXTENSION	0-127
2CH	0vvv vvvv	EXTENSION	0-127
2DH	0vvv vvvv	EXTENSION	0-127
2EH	0vvv vvvv	EXTENSION	0-127
2FH	0vvv vvvv	EXTENSION	0-127
30H	0vvv vvvv	EXTENSION	0-127
31H	0vvv vvvv	EXTENSION	0-127
32H	0vvv vvvv	EXTENSION	0-127
33H	0vvv vvvv	EXTENSION	0-127
34H	0vvv vvvv	EXTENSION	0-127
35H	0vvv vvvv	EXTENSION	0-127
36H	0vvv vvvv	EXTENSION	0-127
37H	0vvv vvvv	EXTENSION	0-127
38H	0vvv vvvv	EXTENSION	0-127
39H	0vvv vvvv	EXTENSION	0-127
3AH	0vvv vvvv	EXTENSION	0-127
3BH	0vvv vvvv	EXTENSION	0-127
3CH	0vvv vvvv	EXTENSION	0-127
3DH	0vvv vvvv	EXTENSION	0-127
3EH	0vvv vvvv	EXTENSION	0-127
3FH	0vvv vvvv	EXTENSION	0-127
40H	0vvv vvvv	EXTENSION	0-127

4.5 Reverb Block

Offset Address	Description
00 00H	0000 aaaa REVERB DATA 1
00 01H	0000 bbbb aaaa bbbb 0-255
00 02H	0000 aaaa REVERB DATA 2
00 03H	0000 bbbb aaaa bbbb 0-255
:	:
:	:
02 76H	0000 aaaa REVERB DATA 188
02 77H	0000 bbbb aaaa bbbb 0-255

*76 bytes of data is mutually related, and each one has no meaning individually.

4.6 System area

Offset Address	Description
00H	0000 0000 PATCH MEMORY WRITE
01H	0000 0000

Temporary area data will be written in the patch memory which had been selected before editing. If a card patch had been selected, PATCH MEMORY WRITE will be ignored.

5. TRANSMITTED EXCLUSIVE MESSAGES IN NORMAL MODE

5.1 Data set (One Way) DT1 12H

- Transmitted in the following two cases.
- 1) When Request Data (RQ1) is recognized, Data set is transmitted on the channel set with Basic CH of MIDI func., regardless of the transmit channel set in the patch. The size of the Data set is according to the address size specified by Request Data (RQ1).
 - 2) When any one of Patch group, bank, number button is pressed, all data in the Temporary area (all parameters of selected patch and tones) is transmitted if Exclu of MIDI Function is set "P-Dump". In this case, it is transmitted on the transmit channel set in the patch.

6. RECOGNIZED EXCLUSIVE MESSAGES IN NORMAL MODE

6.1 Request Data (One way) RQ1 11H

Recognized if Exclu in the MIDI function is ON or P-Dump.

6.2 Data set (One Way) DT1 12H

Recognized if Exclu in the MIDI function is ON or P-Dump.

7. TRANSMITTED EXCLUSIVE MESSAGES IN DATA TRANSFER MODE

Transmitted on the channel set with Basic CH of MIDI Function, regardless of the transmit channel set in the patch.

Address of first Data set command (DT1), Want to send data (WSD) or Request data (RQD) is [02-00-00] (top of memory area)

7.1 One way transfer

7.1.1 Data set DT1 12H

Transmitted when "Enter" button is pressed in "Bank Dump" mode.

7.2 Handshaking Communication

7.2.1 Want to send data WSD 40H

Transmitted when "ENTER" button is pressed in "Bank Dump" mode.

7.2.2 Request Data RQD 41H

Transmitted when "ENTER" button is pressed in "Bank Load" mode.

8. RECOGNIZED EXCLUSIVE MESSAGES IN DATA TRANSFER MODE

If the assigned address exceeds Memory area, it is ignored. The size that exceeds Memory area will not be assigned.

8.1 One Way Transfer

8.1.1 Data set DT1 12H

8.2 Handshaking Communication

8.2.1 Want to send data WSD 40H

8.2.2 Request Data RQD 41H

8.2.3 Data set DAT 42H

8.2.4 Acknowledge ACK 43H

8.2.5 End of Data EOD 45H

8.2.6 Communication Error ERR 4EH

8.2.7 Rejection RJC 4FH

Address Map

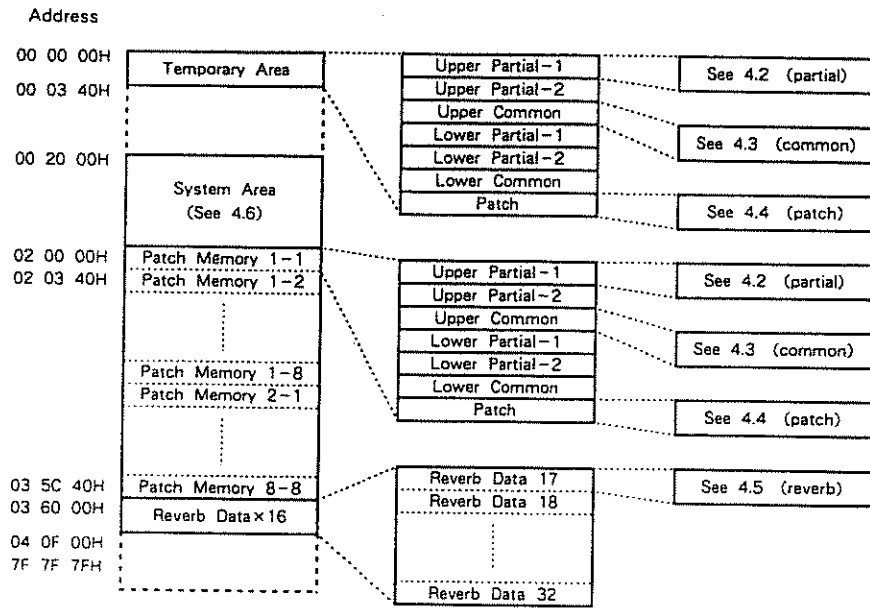

MIDI Implementation Chart

Function...		Transmitted	Recognized	Remarks
Basic Channel	Default Changed	1-16 1-16	1-16 1-16	Memorized
Mode	Default Messages Altered	X *****	Mode 1, 3, 4 MONO,POLY,OMNI ON/OFF Mode 2 → Mode 1	Memorized
Note Number	True Voice	X *****	0-127 12-108	
Velocity	Note ON Note OFF	X X	○ v=1-127 X	
After Touch	Key's Ch's	X X	X *	
Pitch Bender		X	* 0-12 semi	9 bit resolution
Control Change	1 5 7 0. 2-4. 8-31 6. 38 64 65 66-95 100. 101	X X X X X X X X	* * * ○ ** * * ○ ** (0, 1)	Modulation Portamento Time Volume Tone Balance Data Entry (MSB, LSB) Hold 1 Portamento SW Chase RPC (LSB, MSB)
Prog Change	True #	X *****	* 0-127 0-127	
System Exclusive		*	*	
System Common	Song Pos Song sel Tune	X X X	X X X	
System Real Time	Clock Commands	X X	X X	
Aux Message	Local ON/OFF All Notes OFF Active Sense Reset	X X X X	X ○ (123-127) ○ X	
Notes		* Can be set to ○ or X manually, and memorized. ** RPC=Registered parameter control number. RPC#0 : Pitch bend sensitivity RPC#1 : Master fine tuning Parameter values are given by Data Entry.		

Mode 1 : OMNI ON, POLY
Mode 3 : OMNI OFF, POLY

Mode 2 : OMNI ON, MONO
Mode 4 : OMNI OFF, MONO

○ : Yes
X : No

*Recognized if key mode in patch function is 'Sep' or 'Sep-S'.

Function...		Transmitted	Recognized	Remarks
Basic Channel	Default Changed		1-16 1-16	Memorized
Mode	Default Messages Altered	*****	Mode 3, 4 (M=1) X	Memorized
Note Number	True Voice	*****	0-127 12-108	
Velocity	Note ON Note OFF		O v=1-127 X	
After Touch	Key's Ch's		X *	
Pitch Bender			* 0-12 semi	9 bit resolution
Control Change	1 5 7 6, 38 64 65 100, 101		* * X ** * * ** (0)	Modulation Portamento Time Volume Data Entry (MSB, LSB) Hold 1 Portamento SW RPC (LSB, MSB)
Prog Change	True #	*****	X	
System Exclusive			X	
System Common	Song Pos Song scl Tune		X X X	
System Real Time	Clock Commands		X X	
Aux Message	Local ON/OFF All Notes OFF Active Sense Reset		X O (123) O X	
Notes		* Can be set to O or X manually, and memorized. ** RPC=Registered parameter control number. RPC#0 : Pitch bend sensitivity Parameter values are given by Data Entry.		

Mode 1 : OMNI ON, POLY
Mode 3 : OMNI OFF, POLY

Mode 2 : OMNI ON, MONO
Mode 4 : OMNI OFF, MONO

O : Yes
X : No

Roland®

10962

UPC 10962



10962

Roland®