

KORG[®]

EX-800

*PROGRAMMABLE
POLYPHONIC SYNTHESIZER MODULE*

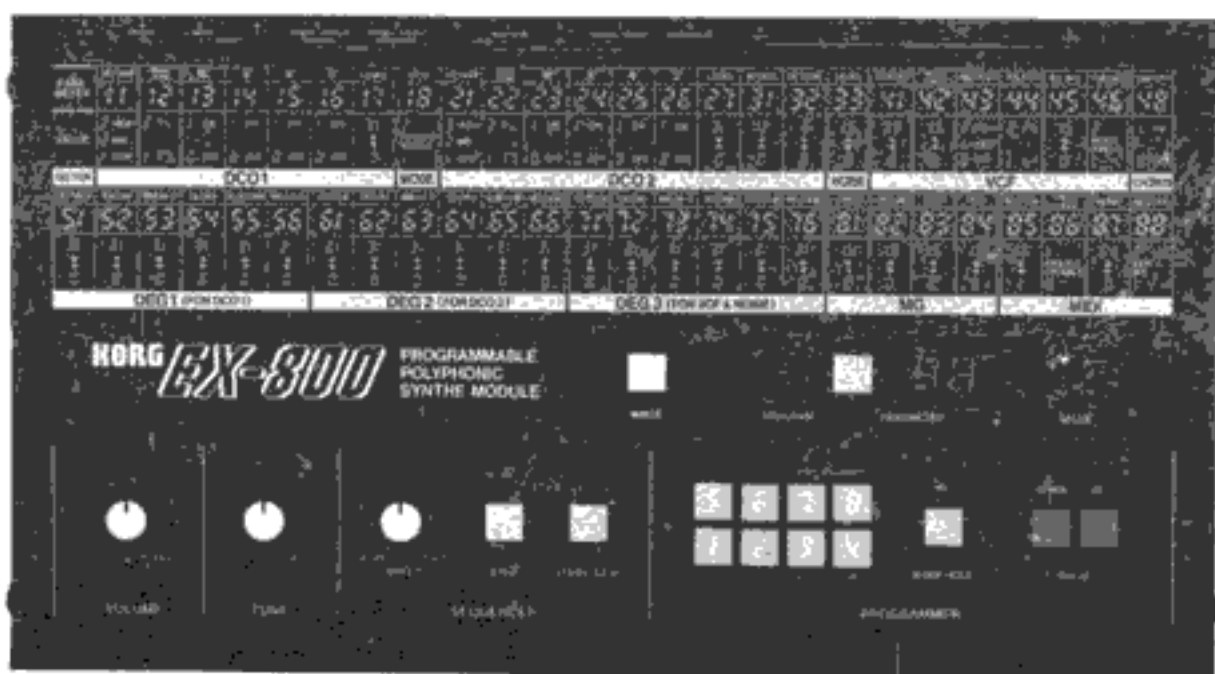

OWNER'S MANUAL

TABLE OF CONTENTS

• IMPORTANT NOTES	5
• FRONT PANEL NOMENCLATURE	6
• REAR PANEL NOMENCLATURE	8
• BASIC CONNECTIONS	9
• FUNCTION AND OPERATIONS	10
1. INITIAL SETUP	10
2. SELECTING PROGRAMS	10
3. SOUND SYNTHESIS	12
3-1 What is a Synthesizer	12
3-2 What is a Program	12
3-3 Digital access control system	12
3-4 EX-800 Synthesizer Modules and Parameters	13
3.4.1. DCO 1	13
3.4.2. MODE	14
3.4.3. DCO 2	15
3.4.4. NOISE	15
3.4.5. VCF	16
3.4.6. CHORUS	17
3.4.7. DEG	18
3.4.8. MG	20
3.4.9. MIDI	20
4. CREATING SOUNDS	22
4-1 Overview	22
4-2 Editing programs	22
4-3 Writing programs to memory	24
4-4 Moving programs	25
5. PERFORMANCE FEATURES	27
5-1 Tune	27
5-2 Sequencer	27
5-3 Program Up Footswitch	30
6. MUSICAL INSTRUMENT DIGITAL INTERFACE (MIDI)	31
6-1 MIDI IN	31
6-2 MIDI OUT	31
6-3 MIDI THRU	31
6-4 MEMORY TRANSFER	31
6-5 TYPICAL CONNECTIONS	31
7. TAPE INTERFACE	34
7-1 Saving program and sequencer data on tape	34
7-2 Recorded data tones	35
7-3 Verify	35
7-4 Loading data into the EX-800	37
8. POWER SUPPLY	39
9. RACK MOUNTING	39
• SPECIFICATIONS/OPTIONS	40
• MIDI IMPLEMENTATION	41

FEATURES

1. Controllable through MIDI interface, the EX-800 offers easy and low cost expansion capabilities, with eight separately articulated voices and 64-program memory.
2. DCOs provide pitch stability. Double mode pairs two voices per note, for complex layered sounds.
3. Digital Access Control System gives fast pushbutton program and parameter selection/adjustment.
4. Nine advanced Digital Envelope Generator (DEG) modules with six parameters per DEG.
5. Built-in Polyphonic Sequencer stores and performs up to 256 notes, and can be synced to external devices.
6. Built-in programmable stereo chorus adds rich ambience effects.
7. Tape Interface allows sets of programs and sequencer data to be saved to and loaded back from cassette tape. Fast 14-second operation.
8. Program, Sequencer and other data can be loaded to external computers and other devices via MIDI, for extended storage capabilities.

IMPORTANT NOTES

To ensure long life for the EX-800, the following precautions should be taken:

LOCATION:

To avoid malfunction, do not use or leave the EX-800 in the following locations for long periods of time:

- In direct sunlight.
- In extremely high or low temperature or humidity.
- In dusty or sandy places.

MUSICAL INSTRUMENT - HANDLE WITH CARE!

- The EX-800 may malfunction if excessive force is applied to the switches and/or knobs or if it is dropped.

CLEANING:

- Use only a soft dry cloth to clean the surface of the EX-800. NEVER use benzene, thinners or similar solvents.

INTERFERENCE FROM OTHER ELECTRICAL APPLIANCES

The EX-800 uses advanced digital circuitry which may occasionally malfunction due to interference produced by fluorescent lamps, other digital equipment, or electrical appliances with built-in motors. We recommend that you use the EX-800 as far as possible from such appliances. If any irregularities occur, turn the power switch off, wait about 30 seconds, then turn the power on again. This should help return the EX-800 to its normal operating condition.

WARRANTY

The EX-800 is warranted by the manufacturer against defects in materials or workmanship. The specific conditions and terms of the warranty are listed on the enclosed warranty registration card.

INSTRUCTIONS

To obtain the best possible results from your EX-800, please read this manual carefully. Keep your Owner's Manual in safe place for future reference.

FRONT PANEL NOMENCLATURE

Parameter index

	DC 9V	PHONES	L/MONO	OUTPUT	R	DISABLE/ENABLE PROGRAM	WRITE	DISABLE/ENABLE SEQUENCER	HIGH/LOW	FROM	TAPE	TO	DS
PARAMETER	OCTAVE	WAVE-FORM	16'	8'	4'	2'	LEVEL	DCO	OCTAVE	WAVE-FORM	16'	8'	
VALUE	3 HIGH 2 MID 1 LOW	2 ∇ 1 \square	1 ON 0 OFF	1 ON 0 OFF	1 ON 0 OFF	1 ON 0 OFF	31 ↑ 0	2 DOUBLE WHOLE 1	3 HIGH 2 MID 1 LOW	2 ∇ 1 \square	1 ON 0 OFF	1 ON 0 OFF	
SECTION	DCO1							MODE					
ATTACK	DECAY	BREAK P.	SLOPE	SUSTAIN	RELEASE	ATTACK	DECAY	BREAK P.	SLOPE	SUSTAIN	RELEASE	ATTAC	
51	52	53	54	55	56	61	62	63	64	65	66	71	
31 ↑ 0	31 ↑ 0	31 ↑ 0	31 ↑ 0	31 ↑ 0	31 ↑ 0	31 ↑ 0	31 ↑ 0	31 ↑ 0	31 ↑ 0	31 ↑ 0	31 ↑ 0	31 ↑ 0	
DEG1 (FOR DCO1)						DEG2 (FOR DCO2)							

KORG EX-800

PROGRAMMABLE
POLYPHONIC
SYNTH MODULE

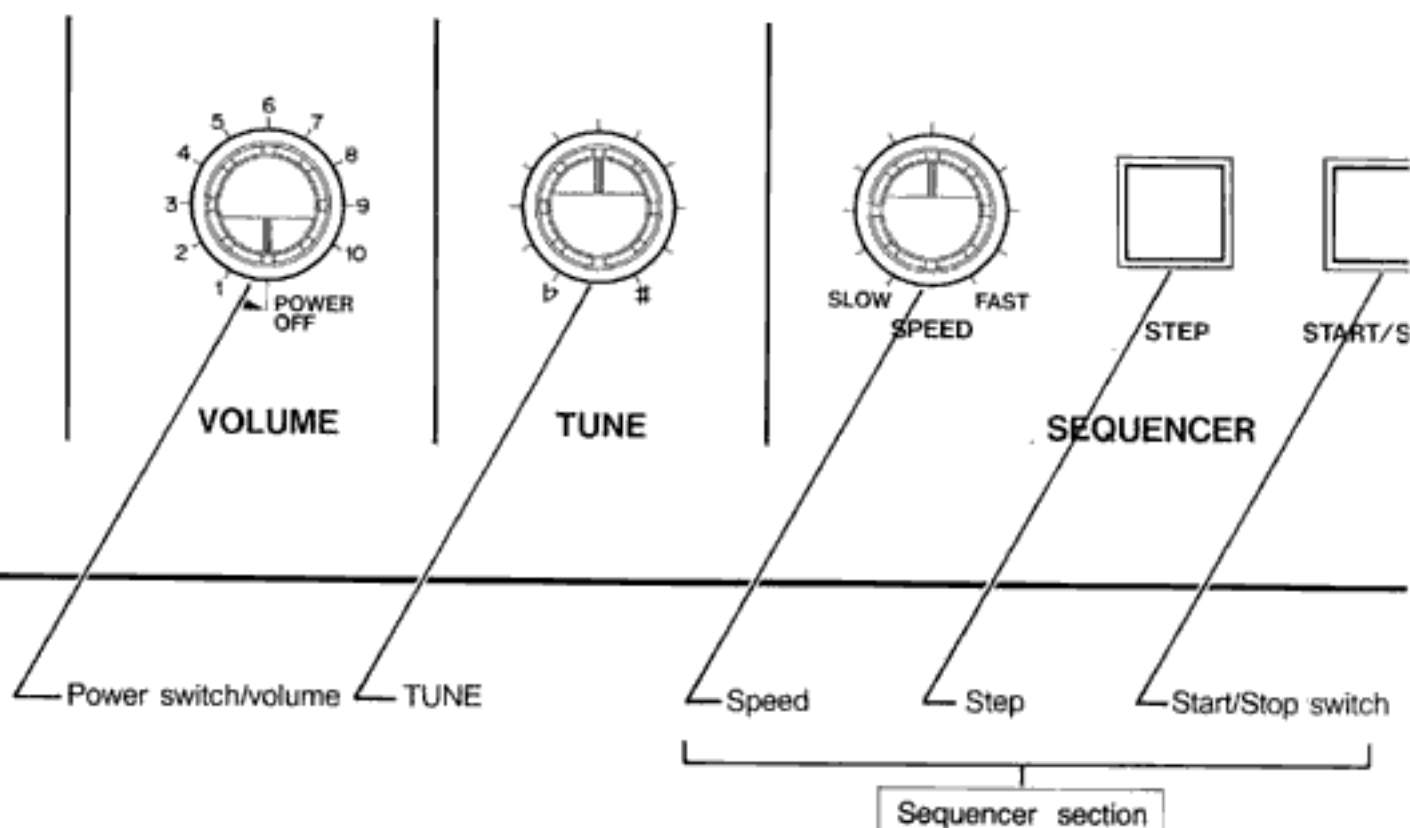

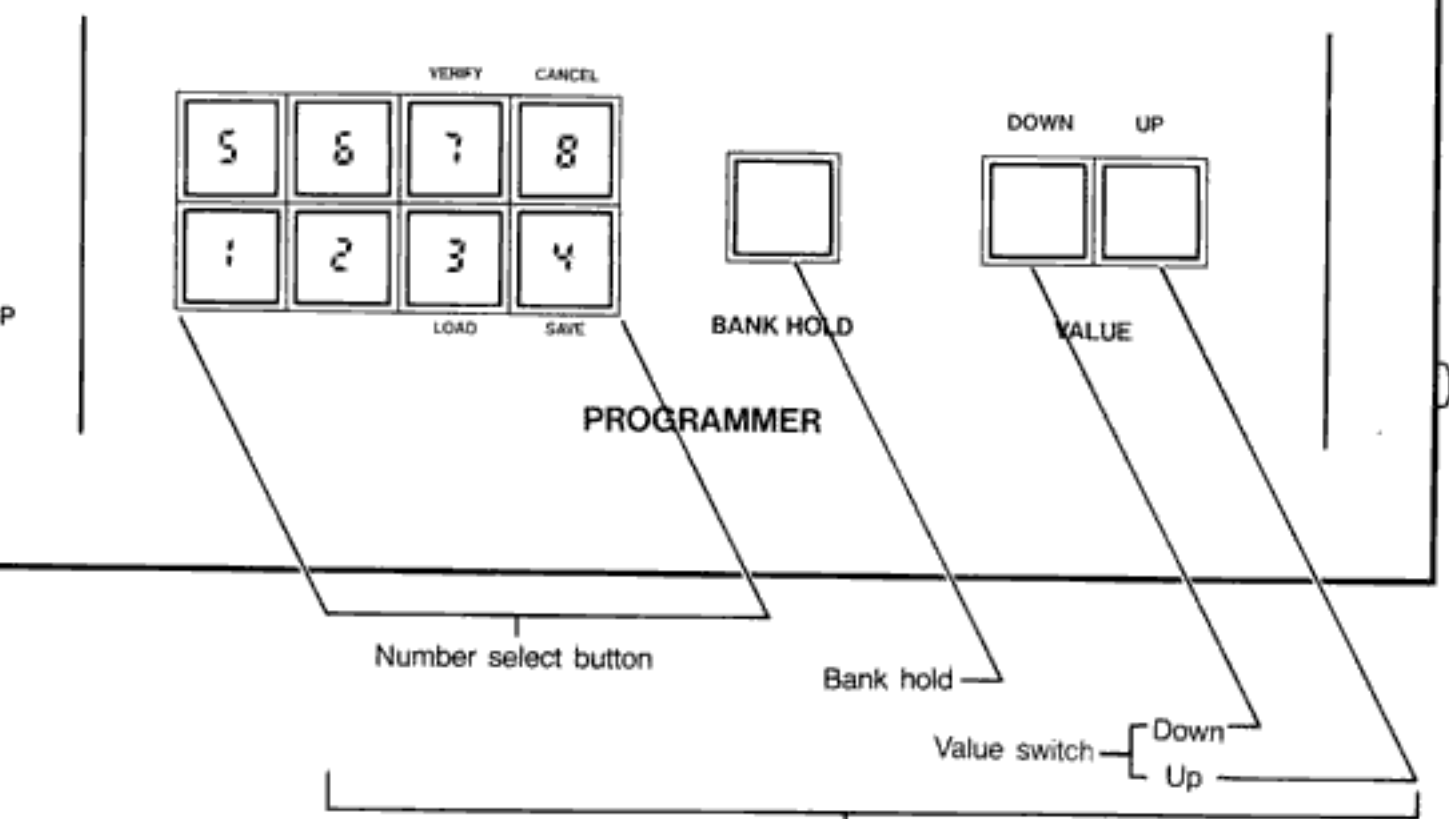
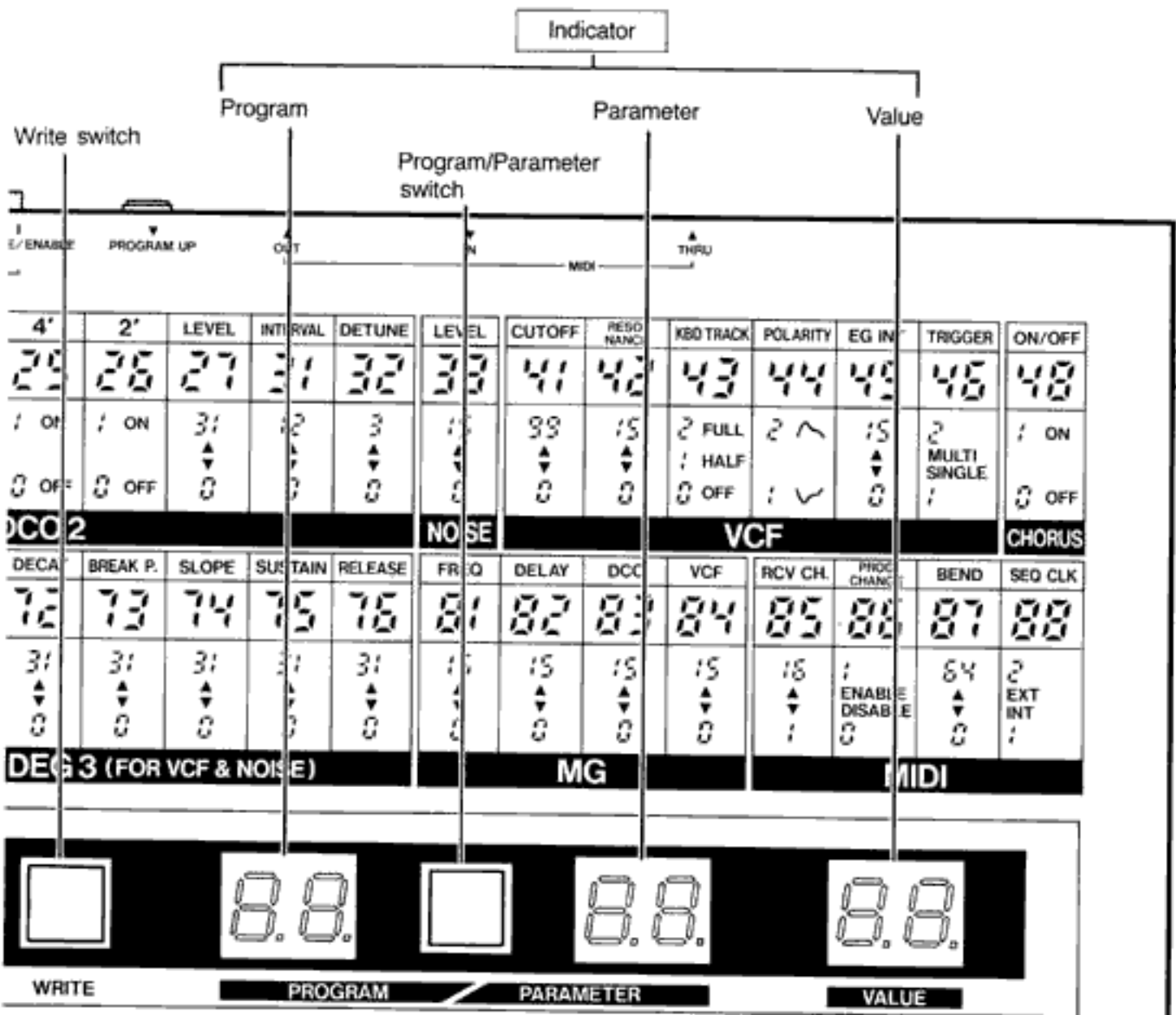

Programmer section

REAR PANEL NOMENCLATURE

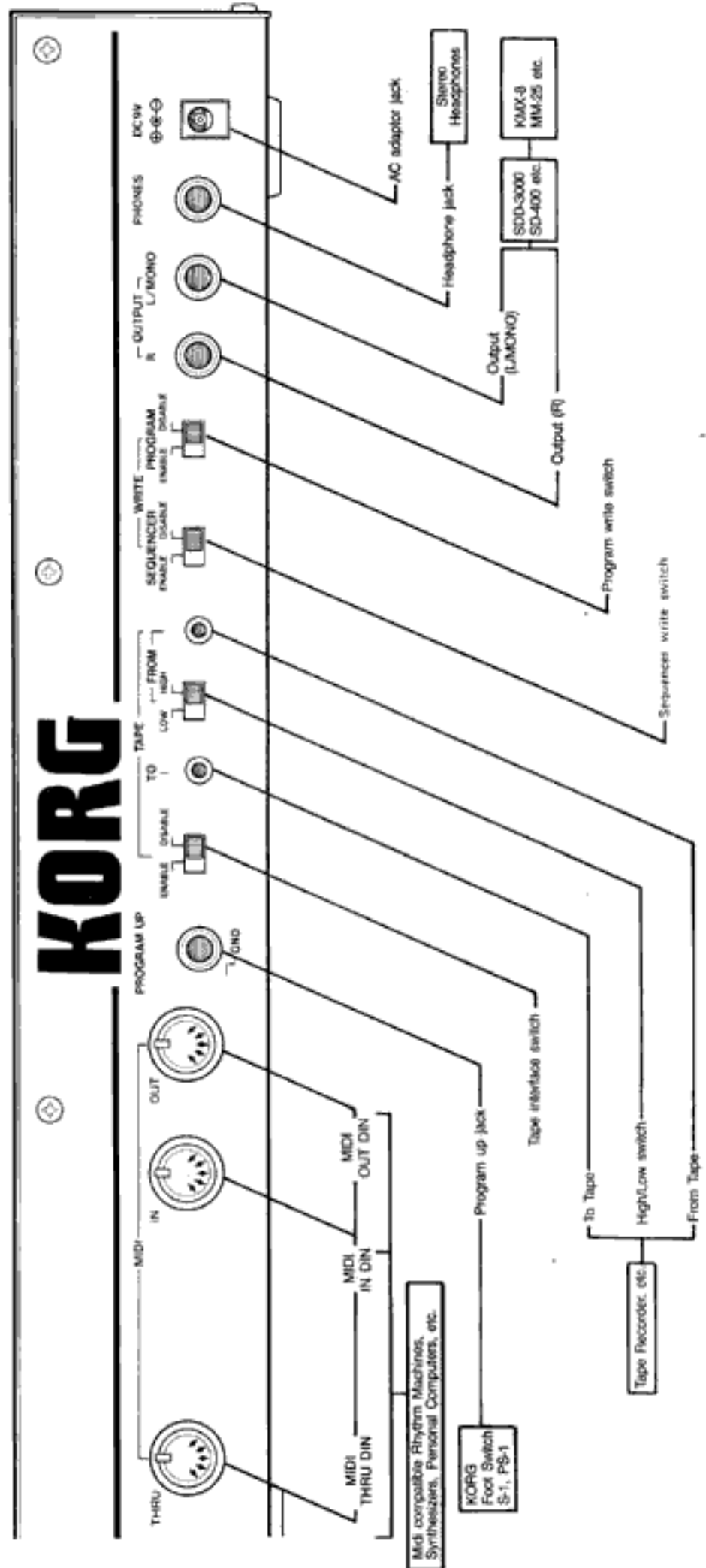
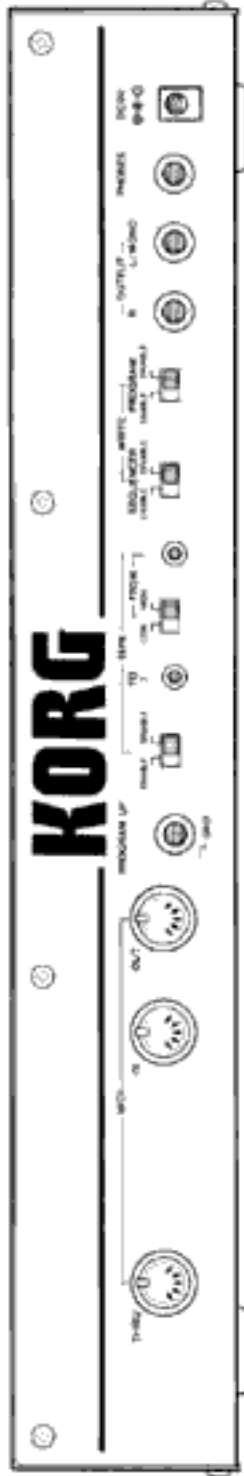

BASIC CONNECTIONS

The EX-800 is an expander unit designed to work with other MIDI equipped devices, such as a POLY-800 or other MIDI equipped synthesizer, remote keyboard, or sequencer. With a suitable MIDI interface and software, the EX-800 can also be connected to a personal computer.

Before using your EX-800 please read the following instructions.

1. Make sure that the Power switch is turned off (VOLUME control fully counterclockwise).

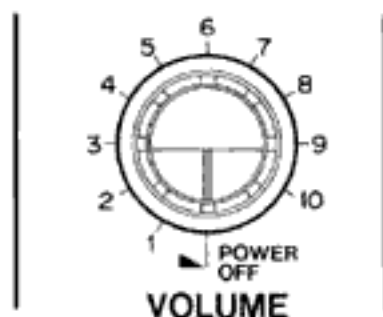

2. Power supply connection.

Use only the exclusive AC adaptor supplied with your EX-800.

3. When using an amplifier or mixer, connect the EX-800 rear panel output jack(s) to the amplifier or mixer input jack(s)

NOTE:

Use the rear panel L/MONO jack if you want to connect the EX-800 to just one amp or one mixer channel. Use L/MONO and the R output for stereo connection. In this case, the output will become phase inverted stereo when the EX-800's built-in chorus effect is turned on.

4. When using headphones:

- Plug headphones into PHONES jack.

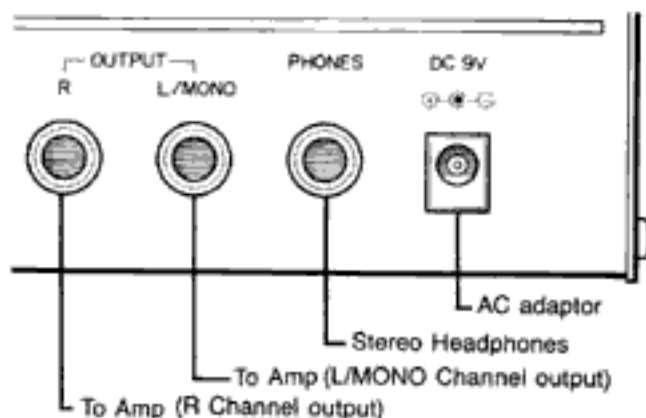

5. MIDI connection

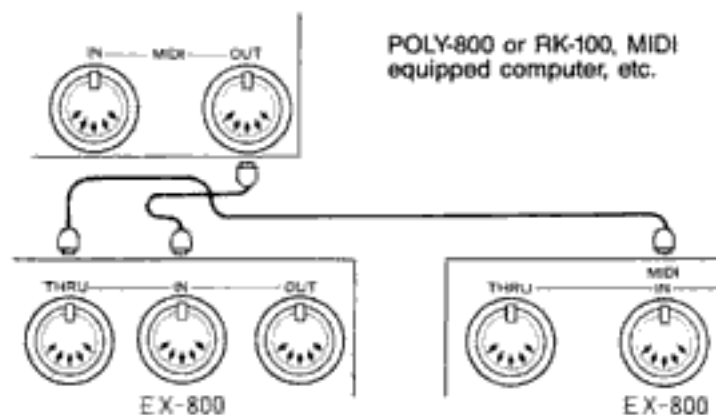

For all MIDI connections, please use the supplied 5-pin MIDI Cable, or any other MIDI compatible cable with appropriate MIDI connectors. The use of audio-type non-MIDI "DIN" Cables may lead to undesirable interference, and is not recommended.

Connect one end of the MIDI cable to the EX-800's "MIDI-IN" jack, and the other end to the output ("MIDI-OUT") from a POLY-800, POLY-61M, RK-100 or any other synthesizer or remote keyboard with MIDI-OUT jacks. Connection to a home computer with an appropriate MIDI Interface is also possible. The "MIDI-THRU" jack is essentially a "bypass" or "foldback" jack which directly outputs any information coming into the MIDI-IN jack without modification. The MIDI-THRU jack is used to add additional synthesizers, expander modules, rhythmers, etc. onto the same MIDI line, for "Multi-Channel" operation. This interconnection system is known as a "Daisy Chain", and ensures that all devices thus connected receive exactly the same MIDI information from the sending device at the same time.

The EX-800's "MIDI-OUT" jack is used to send internal program and sequencer data to an external computer ONLY, via the "COMPU-DUMP" function (see p.31). It CANNOT be used to pass along MIDI "Performance Data" to another synthesizer.

Typical EX-800 Setups

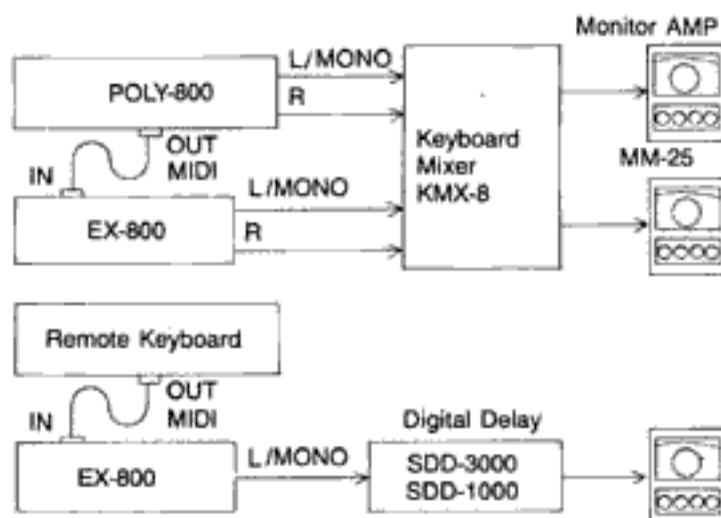

FUNCTION AND OPERATIONS

1. INITIAL SETUP

When setting up the EX-800, please follow the procedure below:

1. Make sure that everything is properly connected as described in Basic Connections, with all power turned OFF.
2. Set the Program and Sequencer WRITE switches and the TAPE switch (on the rear panel) to the DISABLE position.

ORG

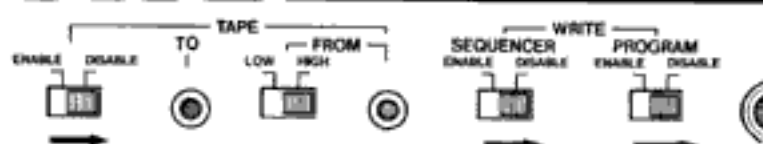

3. Turn on the power switch. (If you are using an amplifier, turn the amp Volume all the way down BEFORE turning on the power.) The front panel LED Display will display the following message:



This dot lights up in DOUBLE MODE (4 Voices)

4. If you are using an amplifier, first set the amplifier Volume to a suitable position, and then adjust the EX-800 VOLUME control for the desired level. If the sound becomes harsh or distorted, turn down the EX-800 VOLUME and/or the amp Volume.

2. SELECTING PROGRAMS

Any of the 64 different sounds programmed into the EX-800's memory may be instantly selected. Each program location is identified by a two digit "Program Number", which is used whenever a program is stored, recalled or moved from one location (Program Number) to another.

(1) Program Numbers

A program number is a two digit number ranging from 11 to 88 (the digits 0 and 9 are not used). The first digit indicates the Program "Bank", and the second number indicates the individual program WITHIN that Program Bank. For example, Program Number 36 would be program #6 in bank 3. The 64 program locations are arranged in 8 banks or groups of 8 programs each:

Program numbers	Number of programs	Total
11 - 18	8	64
21 - 28	8	
31 - 38	8	
41 - 48	8	
51 - 58	8	
61 - 68	8	
71 - 78	8	
81 - 88	8	

(2) Selecting Programs

When the Power switch is first turned on, the LED Display shows the following:



The display indicates Program Number "11" and the "POLY" mode, the normal playing mode, have been selected.

NOTE:

The eight number buttons are used both to SELECT PROGRAMS and to SELECT PARAMETERS within a program. When the EX-800 is turned on, Program Select mode is automatically chosen (only three characters shown in the Display). The PROG/PARA button is used to switch between the two modes.

IF ALL 6 DIGITS ARE DISPLAYED, YOU ARE IN PARAMETER MODE AND SHOULD PRESS THE "PROG/PARA" BUTTON IN ORDER TO SELECT A NEW PROGRAM.

Now try selecting a different program.

1. Select any number from 11 to 88.

Examples: Selecting program number 23.

Press the Number Select Button 2, and the indicator will display the following:



The dash in the right hand digit position means that the EX-800 is waiting for you to select the second digit. (The old program will sound until the second digit is entered.)

NOTE:

If the first digit was selected incorrectly, just press the desired Number Select Button (2 in the example) twice so that the correct Program Number appears in the left-hand digit position. Then enter the correct second digit to finish selecting the desired program.

2. Press the Number Select Button 3 to select the second digit, and make sure that the DISPLAY shows 23. You can now play Program 23.



3. Try selecting and listening to any of the 64 preprogrammed factory programs, in any order you like. You'll find that with a little practice you can select any desired program very quickly. The Bank Hold features, described below, makes program selection even easier in live performance situations.

(3) Bank Hold

The Bank Hold feature allows the current Program Bank Number (left-most digit) to be "held" this enables you to select any of the eight programs in that bank with a single press of a button, for the fastest possible program access.

EXAMPLE: Selecting Bank #2

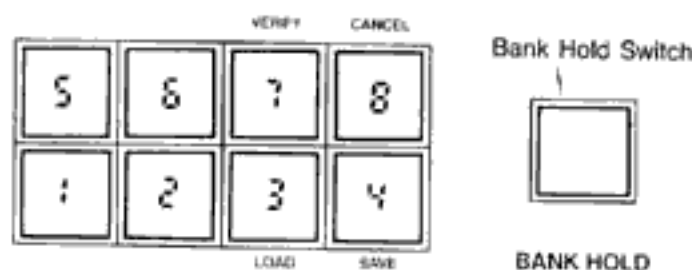

Select any program between 21 and 28 (or simply press "2") and then press Bank Hold. The DISPLAY will show the following:



You may now select any of the eight programs from 21 to 28 by simply pressing a single digit between "1" and "8". As long as the small LED dot next to the Bank digit is lit, you can ONLY select programs between 21 and 28.

To change Banks, or cancel the Bank Hold function, simply press the Bank Hold switch again. The small LED dot will go out, and the regular two-digit selection mode will be restored.

(4) Program Up

The PROGRAM UP jack (connected to an optional footswitch) allows you to change programs in sequence without taking your hands off the Keyboard. This jack accepts "switch triggers" from a momentary contact normally open footswitch or other external device.

3. SOUND SYNTHESIS

3.1 What is a Synthesizer

A synthesizer is a set of modules or "building blocks" that can be used together to create many different types of sounds. In all synthesizers, there are three basic types of modules: sound SOURCES, sound MODIFIERS, and sound CONTROLLERS.

The basic sound SOURCES used in the EX-800 are eight Digital Controlled Oscillators (DCOs). The DCOs produce the actual pitches, and the selected DCO WAVEFORM (and selection of 2', 4' Harmonics etc.) has a large effect on the tonal quality (timbre) of the sound. A NOISE source is also provided.

The sound MODIFIERS for the EX-800 are the Voltage Controlled Amplifiers (VCAs), the Voltage Controlled Filter (VCF), and the Stereo Chorus. Sound modifiers take the basic sound produced by the sound sources and shape or "fine tune" the sound into its final form — what you actually hear.

- The VCF modifies the blend of overtones (and brightness) in the sound.
- The VCAs control the changes in volume level which provide individual note articulation ... how each note attacks, decays, etc.
- The Stereo Chorus provides extra warmth and "thickness" for almost any sound.

The sound CONTROLLERS don't produce or modify any sounds directly — they tell the sources and modifiers what to do. Controllers in the EX-800 include the Keyboard and Key Assigner, advanced 6-stage Envelope Generators, Modulation Generator, Programmer, Joystick and MIDI Interface.

Without controllers, there would be no way of coordinating the different modules in the synthesizer to produce useful sounds.

MIDI (Musical Instrument Digital Interface) is actually an EXTERNAL Controller, which allows different instruments and equipment to be coordinated for a wide range of new possibilities.

3.2 What is a Program

Each of the sources, modifiers and controllers described above have several PARAMETERS (variable settings such as Waveform, Cutoff, Attack Time, etc.).

A "Program" is the particular collection of Parameter settings that results in a specific desired sound.

3.3 Digital Access Control System

On many synthesizers, knobs must be turned to adjust the Parameters, and it's hard to tell what the exact values are — especially when you're editing an existing program, the most common way of creating new programs.

On the EX-800, each parameter and its value are expressed by a pair of numbers:

- The PARAMETER NUMBER (middle two digits of the six digit DISPLAY) identifies a particular Parameter, which is like a single control knob on other synthesizers (Filter Cutoff, for example, is Parameter #41 on the EX-800).
- The VALUE (righthand two digits) is like the current setting of that control knob, or Parameter (e.g., Filter Cutoff can have a Value between 00 and 99).

The eight Number Buttons (also used for Program Selection), UP and DOWN buttons and large LED Display make it easy to adjust and DOWN button and LED Display make it easy to adjust each program parameter precisely for the exact desired result. To change any aspect of a programmed sound, you simply:

- select a Parameter Number
- adjust its Value, using the UP and DOWN buttons
- repeat above to change other Parameters, as needed.

Further information is given in the section on "Creating Sounds".

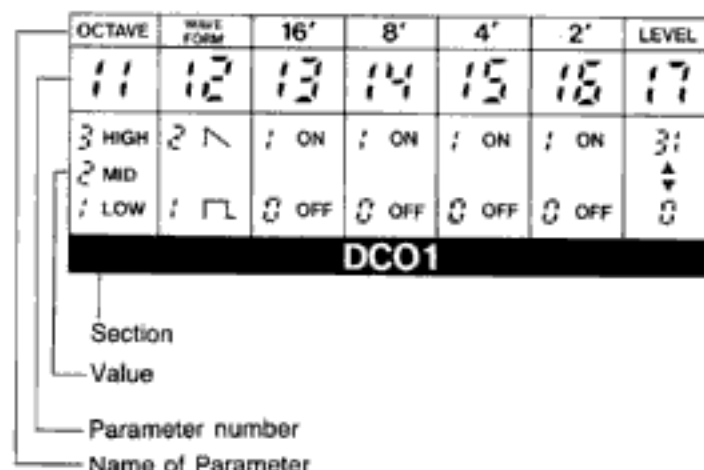



3.4 EX-800 Synthesizer Modules and Parameters

3.4.1 DCO 1

The basic sound sources of the EX-800 are the eight Digitally Controlled Oscillators (DCOs), which offer precise frequency tuning and stability through the use of advanced integrated digital technology.

The EX-800 DCOs operate on a principle of additive squarewave synthesis. Different waveforms are created by adding together, in different proportions, up to four squarewave Harmonics at octave intervals, from 16' to 2' (a four octave range.)

Each DCO then is separately articulated by its own 6-stage Digital Envelope Generator, which allows very complex and interesting sounds to be created, especially when two DCOs are combined per voice in DOUBLE Mode.

OCTAVE	WAVE-FORM	16'	8'	4'	2'	LEVEL
11	12	13	14	15	16	17
3 HIGH	2 	1 ON	1 ON	1 ON	1 ON	31
2 MID	1 	0 OFF	0 OFF	0 OFF	0 OFF	0
1 LOW						
DCO1						

PARAMETER NAMES AND FUNCTIONS

OCTAVE



Determines the basic pitch range over a three octave range (High, Middle, Low). By choosing different combinations of the Octave and Harmonics parameters, you can select a basic pitch range from 1' (highest) to 32' (lowest).

OCTAVE	VALUE
HIGH	3
MID	2
LOW	1

WAVEFORM

The Waveform parameter works together with the 16' - 2' Harmonics parameters (see below) to determine the basic tonal quality (timbre) of the oscillator. The Harmonics parameters turn each squarewave Harmonic ON and OFF. The Waveform parameter

selects the actual LEVELS of the individual squarewave Harmonics which are added together to create the final waveform.

The EX-800 provides a choice of two waveforms (harmonic levels): Squarewave () at Value 1, and Sawtooth () at Value 2.

- With a Waveform Value of 1, all of the squarewave Harmonics (that are turned ON) are added together at equal volume:

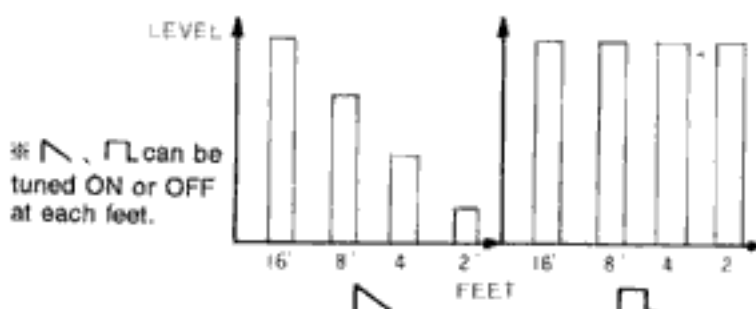

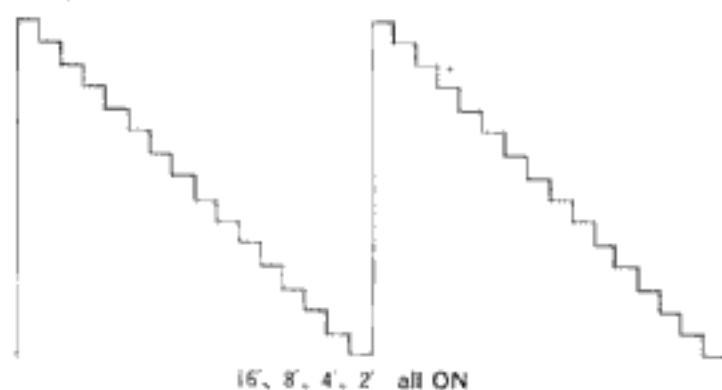

Step Wave

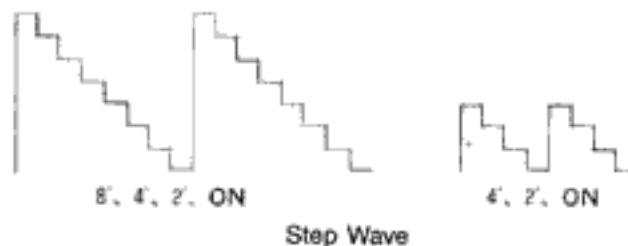

- With a Waveform Value of 2, each Harmonic (that is turned ON) is combined with a different relative volume (16' is loudest, 2' is softest):



WAVE FORM	VALUE
	2
	1

13 15 HARMONICS (16' 8' 4' 2')

The Harmonics parameters turn any combination of individual squarewave harmonics on and off, regardless of the Waveform Parameter Value. This allows a wide variety of different waveforms to be created. For example, you could add together just the 16' and 4' harmonics, at either the same level (Square Waveform), or with the 16' harmonic 3 times louder than the 4' harmonic (Sawtooth Waveform).

- When a Square Waveform is selected (Value of 1), and any single ONE of the Harmonics parameters is ON, a regular square wave is produced at the selected pitch range.
- Combining TWO OR MORE of the Harmonics with the Square Waveform selected produces octave doubling "effects."
- When the Waveform Value is 2, and ALL of the 16' - 2' Harmonics are turned ON, the DCO waveform will be a close approximation of a sawtooth waveform.

16'	8'	4'	2'	VALUE
ON	ON	ON	ON	1
OFF	OFF	OFF	OFF	0

- With all Harmonics turned ON, the basic pitch range will be selected by the Octave parameter (11). However, several types of modified sawtooth waveforms are available by turning OFF 1 or 2 of the higher Harmonics, and higher-pitched sawtooths are available by turning OFF the 16' or 16' & 8' Harmonics.

17 LEVEL

The maximum level of DCO 1 can be adjusted over a range of 0 (off) to 31 (full). This is useful both for adjusting the overall volume to match other programs, and for balancing DCO 1 and DCO 2 in Double Mode.

LEVEL	VALUE
Max.	31
↓	↓
Min.	0

NOTE:

Since each DCO is articulated by its own Digital Envelope Generator, the LEVEL parameter actually determines how loud the DCO will be when the DEG reaches its Attack peak.

3.4.2 MODE

The DCO MODE parameter determines the basic architecture of the EX-800:

- WHOLE Mode 8 individual voices with 1 DCO and 1 DEG per voice. (LED Dot OFF)
- DOUBLE Mode 4 individual voices with 2 DCOs and 2 DEGs per voice. (LED Dot ON)

The LED Dot next to the Key Assign Mode Display always shows whether the currently selected Program is in WHOLE Mode or DOUBLE Mode:

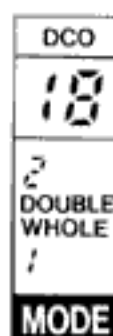

The Dot is lit when DOUBLE Mode is selected.

In WHOLE Mode, all 8 DCOs are controlled by the DCO 1 Parameters (11 - 17), and the 8 related DEGs are all controlled by the DEG 1 Parameters (51 - 56).

Trying to access any DCO 2 or DEG 2 Parameters (21 - 32 and 51 - 56) will produce a blank readout in the Value display, to show that they are not currently being used. However, the previous values of these parameters are still saved in memory, and will be available again when DOUBLE Mode is selected.

In DOUBLE Mode, 4 DCOs and DEGs are controlled by the DCO 1 and DEG 1 parameters, and the other 4 DCOs and DEGs are controlled by the DCO 2 and DEG 2 parameters. Exceptionally dynamic and realistic sounds result from using a SEPARATELY programmed 6-stage Digital Envelope Generator to control EACH of the two DCOs that are "layered" together for each note.)

MODE	VALUE
DOUBLE (4 Voices)	2
WHOLE (8 Voices)	1

3.4.3 DCO 2 (DOUBLE Mode only)

DCO 2 can be combined with DCO 1 to produce a wide variety of warm, thick sounds. The DCO 2 parameters are only active in DOUBLE Mode (see description of MODE Parameter, above).

OCTAVE	WAVEFORM	16'	8'	4'	2'	LEVEL	INTERVAL	DETUNE
21	22	23	24	25	26	27	31	32
3 HIGH	2	1 ON	1 ON	1 ON	1 ON	31	12	3
2 MID	1	0 OFF	0 OFF	0 OFF	0 OFF	0	0	0
1 LOW	0	0 OFF	0 OFF	0 OFF	0 OFF	0	0	0

DCO 2

PARAMETER NAMES AND FUNCTIONS

- 21** **OCTAVE**
Similar to DCO 1. The three octave range includes High, Middle and Low.
- 22** **WAVEFORM**
Similar to DCO 1. There is a choice of square wave () or sawtooth () .
- 23** - **26** **HARMONICS (16' 8' 4' 2')**
Similar to DCO 1. Each of the four squarewave harmonics may be individually turned ON or OFF.
- 27** **LEVEL**
Similar to DCO 1. DCO 2 is controlled by DEG 2, not by DEG 1.

LEVEL	VALUE
Max.	31
↓	↓
Min.	0

- 31** **INTERVAL**
The pitch of DCO 2 may be transposed or "offset" so that it sounds at a constant interval above DCO 1. The range of this parameter is a full octave in semitone steps (0 - 12).
- When Interval Value equals 0, DCO 1 and DCO 2 are in Unison. When the Value equals 7, DCO 2 will be a perfect 5th (7 semitones) above DCO 1.
- With a Value of 12, DCO 2 will be an octave higher than DCO 1. This is useful for extending the range of the Keyboard, or for tuning the two DCOs to be three octaves apart.

INTERVAL	VALUE
1 Octave	12
↓	↓
Perfect Dominant	0

NOTE:
The Octave and Harmonics parameters also affect the relative tuning of the DCOs. For example, if Interval equals 7 but DCO 1 Octave equals 'Low' and DCO 2 Octave equals 'Middle', then DCO 2 will actually be a perfect 4th BELOW DCO 1, not a perfect 5th above DCO 1. This would also happen if both DCOs were set to the same Octave, but the DCO 1 16' Harmonic was turned OFF.

- 32** **DETUNE**
The Detune parameter provides fine pitch adjustment of DCO 2 relative to DCO 1. Detuning DCO 2 creates a 'fatter' sound because of the slight pitch differences between the two oscillators.
- Detune Values can range from ' 0 ' (no detuning) to ' 3 ' (full detuning).

DETUNE	VALUE
Pitch difference from DCO	3
Max.	↓
↓	↓
Same pitch as DCO 1	0

3.4.4 Noise

The White Noise Generator can be used for a variety of special effects, either by itself or mixed with the DCOs. Unlike any other synthesizer, the EX-800 can "envelope" or articulate Noise SEPARATELY from the oscillators, which can be used to add small amounts of "breath noise" to simulated acoustic instrument sounds.

- The LEVEL parameter sets the MAXIMUM noise level over a range of 0 (off) to 15 (full).
- Noise level is also controlled by Digital Envelope Generator 3 (DEG 3), which also controls the VCF. The Noise LEVEL parameter actually determines how loud Noise will be when DEG 3 reaches its Attack peak.

LEVEL	VALUE
15	15
↓	↓
0	0

NOISE

3.4.5 VCF

The Voltage Controlled Filter (VCF) controls tonal quality (timbre) by selectively removing and emphasizing different overtones of the DCO waveforms. The VCF used in the EX-800 is a LOW PASS filter: it passes over tones BELOW the Cutoff Frequency and reduces or removes completely the overtones ABOVE the Cutoff Frequency. When RESONANCE is turned up, any overtones very close to the Cutoff Frequency will be emphasized.

Cutoff Frequency is the most important parameter of the VCF. Varying the Cutoff Frequency changes the blend of overtones, resulting in a timbre change (which helps create dynamic and "lifelike" sounds). Cutoff Frequency is determined by the CUTOFF (41), RESONANCE (42), KBD TRACK (43), POLARITY (44) and EG INT (45) parameters. It can be also be affected by DEG 3 and/or by the Modulation Generator (MG).

CUTOFF	RESONANCE	KBD TRACK	POLARITY	EG INT	TRIGGER
41	42	43	44	45	46
99	15	2 FULL	2 ^	15	2
0	0	1 HALF	1	0	MULTI
0	0	0 OFF	1 v	0	SINGLE
VCF					

PARAMETER NAMES AND FUNCTIONS

41 CUTOFF

This parameter directly sets the Cutoff Frequency of the low pass filter.

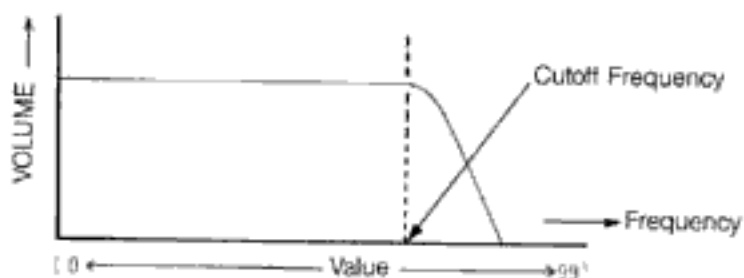

When the Cutoff Value is set to 99 (assuming both KBD Track (43) and EG INT (45) are set to 0), all waveform overtones from the DCOs are passed without any effect, and the sound is very bright.

As Cutoff Value is reduced, more and more harmonics are cut off, producing a more rounded or less bright sound.

When the Cutoff Frequency Value is near 0, nearly all of the waveform is filtered out, resulting in almost no sound.

TIMBRE	VALUE
Bright, unchanged timbre of DCO waveform	99
↓	↑
Soft timbre	
↓	↓
Almost no sound	0

42 RESONANCE

Resonance emphasizes the harmonics near the Cutoff Frequency, producing a characteristic "wah" or "band pass" type of sound.

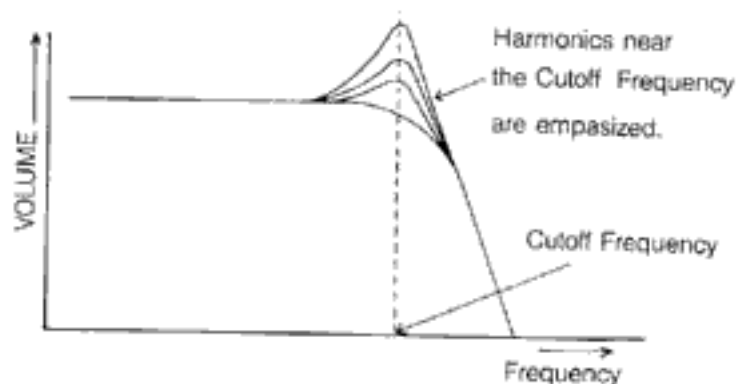

The higher the Value, the stronger the effect of the Filter on the tonal quality (timbre). Resonance can produce typical synthesizer "wah-wah" sounds, helps make instrumental sounds more realistic, and generally provides a good variety of subtle and dramatic effects.

Effect on tone quality	VALUE
Large (Very peaky sound)	15
↓	↑
Small	
↓	↓
None	0

43 KBD TRACK

Keyboard Tracking controls how the VCF Cutoff Frequency changes as you play up and down the keyboard. There are three Values: Full, Half and Off.

Full (2) Cutoff Frequency rises and falls in EXACT PROPORTION to the pitch of the HIGHEST note sounding at any given time (whether played on the keyboard or produced by the Chord Memory feature). This tends to keep timbre (tonal quality) relatively constant as you play up and down the keyboard.

Half (:) Cutoff changes only 1 HALF OCTAVE FOR EVERY OCTAVE change in the highest note played. This tends to make lower notes brighter (more overtones) than higher notes, since the VCF cuts out more and more overtones as the pitch of a note rises.

Off (0) Cutoff is NOT AFFECTED by keyboard pitch. Lower notes are much brighter than higher notes, as explained above.



KBD TRACK	VALUE
100%	2
50%	1
OFF	0

The next three parameters, POLARITY, EG INT and TRIGGER, all affect the way that the VCF "envelopes" or changes timbre over the life of a single note. These contours (produced by DEG 3) are very important in creating expressive sounds. Getting a sound "just right" will often require you to go back and forth between ALL of the VCF parameters several times, since they all interact in producing the final sound.

44 POLARITY

The Polarity parameter determines how the Cutoff Frequency is affected by Digital Envelope Generator #3.

- When Polarity equals 2, the Cutoff Frequency is swept UP during the attack portion of the envelope, and down during the decay portion etc., for a "normal" envelope effect.
- When Polarity equals 1, the Cutoff Frequency is swept DOWN during the attack portion of the envelope (the envelope is inverted).
- If EG INT (45) is zero, the Polarity parameter has no effect, regardless of its setting.

POLARITY	VALUE
	2
	1

45 EG INT

EG Intensity controls how much the VCF Cutoff Frequency is affected (swept) by Digital Envelope Generator #3 (DEG 3). (The Polarity parameter controls which direction the VCF is swept in.)

- EG Intensity has a range of 0 (no sweep) to 15 (maximum sweep).

EG INT	VALUE
Sweep deep	15
↓	
Sweep shallow	
↓	
None	

46 TRIGGER

Selects one of two keyboard triggering modes for DEG 3, which controls the VCF (as well as Noise).

Single (:) DEG 3 will be triggered by the FIRST note played, causing a normal Attack - Decay - Break Point - Slope cycle to sweep the VCF. The Envelope attack cycle will NOT be retriggered (restarted) by any new keys played until ALL keys are released and a new "first key" is played.

This allows you to use your playing style to control when new VCF attacks will occur. For example, legato playing could produce smooth even sounds, while staccato playing could produce sharp percussive sounds.

Multi (2) DEG 3 will be triggered whenever a new note is played, even if other keys are still being held down.

This mode allows fast and fluid playing without having to lift fingers off precisely to produce a consistent sound.

TRIGGER	VALUE
Multi	2
Single	1

NOTE:

The Trigger parameter only affects DEG 3. DEG 1 and 2 are always triggered whenever a new note is assigned to the corresponding DCO.

3.4.6 CHORUS

The built-in Stereo Chorus produces a warm, subtle ambience that enriches many types of sounds. It is especially effective when headphones or both line outputs (panned separately) are used. The Chorus effect may be programmed ON or OFF.

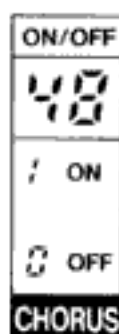

CHORUS	VALUE
ON	1
OFF	0

3.4.7 DEG

The EX-800 has nine Digital Envelope Generators (DEGs). 8 of the DEGs (DEG 1 or DEG 1 & 2) control the volumes of the 8 individual DCOs, providing individual articulation (attack, decay, etc.) for each note. The remaining DEG (DEG 3) dynamically changes the VCF Cutoff and Noise level.

①	②	③	④	⑤	⑥
ATTACK	DECAY	BREAK P.	SLOPE	SUSTAIN	RELEASE
51	52	53	54	55	56
31	31	31	31	31	31
▲	▲	▲	▲	▲	▲
0	0	0	0	0	0

DEG1 (FOR DCO1)

①	②	③	④	⑤	⑥
ATTACK	DECAY	BREAK P.	SLOPE	SUSTAIN	RELEASE
61	62	63	64	65	66
31	31	31	31	31	31
▲	▲	▲	▲	▲	▲
0	0	0	0	0	0

DEG2 (FOR DCO2)

①	②	③	④	⑤	⑥
ATTACK	DECAY	BREAK P.	SLOPE	SUSTAIN	RELEASE
71	72	73	74	75	76
31	31	31	31	31	31
▲	▲	▲	▲	▲	▲
0	0	0	0	0	0

DEG3 (FOR VCF & NOISE)

All Digital Envelope Generators use an advanced 6 stage design. In addition to the normal Attack, Decay, Sustain and Release functions, they include BREAK POINT and SLOPE functions, which control an extra envelope stage that can create either a second attack or a second decay.

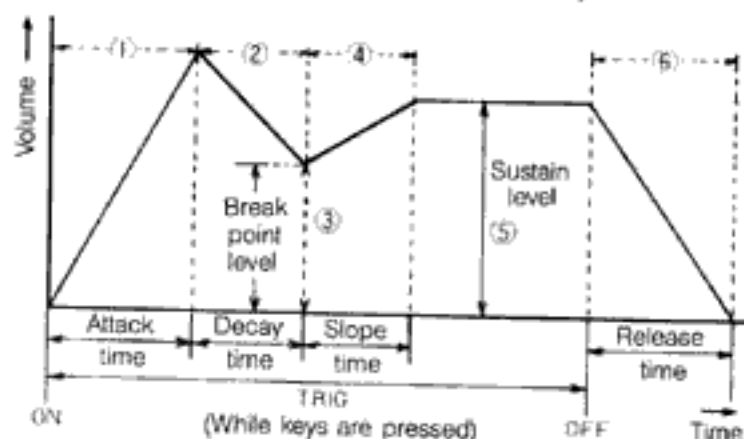

NOTE:

All three DEGs have the same types of parameters, and all parameters have the same range (0-31).

These DEGs provide highly improved percussive and instrumental sounds and many new special effects.

In WHOLE Mode, the 8 DEGs that provide DCO articulation (Volume Envelopes) are all controlled by the DEG 1 parameters (# 51 - 56), so that all notes are articulated in a similar way. In this mode the DEG 2 parameters have no effect (and appear blank if you try to access them).

In DOUBLE Mode, two DCOs and two DEGs are assigned to each note. Each DEG (and DCO) may be programmed separately, creating a wide range of complex, dynamic sounds. DCO 1 is controlled by DEG 1 (# 51 - 56) and DCO 2 is controlled separately by DEG 2 (# 61 - 66). (See section on DCO MODE for further information).

PARAMETER NAMES AND FUNCTIONS

51 · 52 · 71 ATTACK (Rate)

Controls how long it takes for the envelope contour to rise from zero to its maximum level after the key is depressed.

NOTE:

The maximum envelope level can correspond to the maximum DCO or Noise volume (as set by LEVEL parameters # 17, 27, 33). It can also correspond to the highest (or VCF Cutoff Frequency (as set by POLARITY #44 and EG INT #45).

52 · **62** · **72** **DECAY (Rate)**

Determines the rate at which the envelope contour falls from the maximum (Attack) level to the BREAK POINT level, after the ATTACK phase is completed.

- If BREAK POINT equals 31, the DECAY parameter has no effect. There needs to be at least a 1 number difference in starting & ending Levels for Rate parameters to have an effect (the Attack peak is always 31.) The bigger the difference, the longer the actual time produced by a given DECAY value.

- * For example, assume DECAY is 31, with BREAK POINT (B.P.)= 30, the actual Decay cycle lasts about 0.5 seconds. With B.P.= 25, it lasts about 1.2 seconds (DECAY= 31). At B.P.= 20, it lasts about 3 seconds, and at 15, about 5 seconds.

- * SLOPE and RELEASE are similarly affected by changes to BREAK POINT and/or SUSTAIN levels. The bigger the difference between starting & ending levels, the longer the actual time produced by a particular Rate value.

53 · **63** · **73** **BREAK P. (Break Point, Level)**

Determines the envelope level at which the Decay rate changes to the Slope rate. This allows complex two-part decay or decay/attack transients to be created (see Slope description below for examples).

- If the Break Point level is set to maximum (31), the extra envelope stage is effectively disabled, and the envelope becomes a conventional ADSR type. (In this case, SLOPE is used instead of DECAY to set the actual decay rate from the ATTACK peak to the SUSTAIN level.)

- You can also produce a regular ADSR by setting BREAK POINT to the same value as SUSTAIN level. This method allows DECAY to control the decay rate, but requires you to change BREAK POINT whenever you change SUSTAIN.

54 · **64** · **74** **SLOPE (Rate)**

Determines the rate at which the envelope contour moves from the BREAK POINT level to the SUSTAIN level.

- If the Break Point level is LOWER than the Sustain level, then SLOPE functions as a second ATTACK (the envelope moves UP towards the Sustain level).

- If the Break Point level is HIGHER than the Sustain level, then SLOPE functions as a second DECAY (the envelope moves DOWN towards the Sustain level).

- Slope has no effect when Break Point and Sustain are set to the same value.

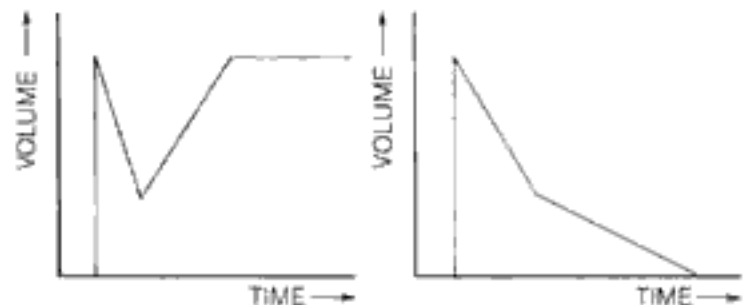

Compressor Guitar Sound, using a second attack.

Piano-type Envelope, using a second decay.

55 · **65** · **75** **SUSTAIN (Level)**

Determines the constant envelope level at which the sound is sustained after the Attack, Decay and Slope phases are completed, for as long as the key is kept depressed.

56 · **66** · **76** **RELEASE (Rate)**

Determines the rate at which the envelope contour falls from the Sustain level to zero after the key is released.

- If the envelope has not yet reached the Sustain level (if still in the Attack, Decay or Slope phase), then the envelope level will fall from its CURRENT value to zero at the Sustain rate.

- As with Decay and Slope, changing the Sustain level automatically changes the actual Release TIME (because Release is a rate.).

Attack time	Decay time	Break point level	Slope time	Sustain level	Release time	VALUE
Long	Long	Highest long	Long	Highest long	Long	31
Short	Short	0	Short	0	Short	0

3.4.8 MG

The Modulation Generator (MG) is a low frequency control oscillator used for regular, cyclic modulation of DCO pitch and VCF cutoff frequency. The MG can be used for vibrato, growl, automatic wah-wah and other "repetitive" effects. MG effects can be programmed into a given sound, added during performance with the Joystick, (or by external devices via MIDI), or both.

PARAMETER NAMES AND FUNCTIONS

FREQ	DELAY	DCO	VCF
01	02	03	04
15 ▲ 0	15 ▲ 0	15 ▲ 0	15 ▲ 0
MG			

81 FREQ

Frequency determines the speed of the cyclic variation in pitch or tone quality (vibrato, wah-wah, etc.). Frequency has a range of 0 - 15; the higher the value, the faster the speed.

Vibrato/Wah-Wah speed	VALUE
Fast	15
↓	↓
Slow	0

82 DELAY

Delay determines the delay (if any) between the time when you play the key and the time when vibrato, wah-wah, etc. begins. Delay has a range of 0 - 15.

With a value of 0, the effect begins as soon as you play the key. The greater the value, the longer the delay before the effect begins. (Depressing additional keys while holding one or more down does NOT retrigger the delay function.)

Delay of MG	Value
Long	15
↓	↓
No delay: the effect begins as soon as the key is played.	0

NOTE:

Delay also affects modulation added through the Joystick.

83 DCO

Determines vibrato depth (depth of DCO frequency modulation).

Vibrato depth	VALUE
Deep	15
↓	↓
No effect	0

84 VCF

Determines depth of Cutoff Frequency modulation (wah-wah or "growl" effect, etc.)

Wah-Wah depth	VALUE
Deep	15
↓	↓
No effect	0

3.4.9 MIDI

MIDI is a data and protocol format for control and communications between synthesizers, sequencers, rhythm machines, and personal computers. (See page 31 for more details.)

Although you are free to set all parameter values as you like, MIDI 85-88 parameters can not be given particular values for particular programs. MIDI parameters will remain the same regardless of which program you select. If you change a MIDI value, that new value will then apply to all programs in memory. Note that parameter 85 (RCV CH) and 87 (BEND) values can be saved along with program data and loaded from tape to internal memory. However, parameter 86 (PROG CHANGE) and 88 (SEQ CLK) cannot be saved to or loaded from tape.

① RCV CH.	② PROG CHANGE	③ BEND	④ SEQ CLK
85	86	87	88
15 ▲ ↓	1 ENABLE DISABLE 0	84 ▲ 0	2 EXT INT ↓
MIDI			

PARAMETER NAMES AND FUNCTIONS

85 RCV CH (Receive Channel)

This determines which MIDI channel will be received by the EX-800. There are 16 possible channels for MIDI reception. When connected to a POLY-800, selecting RCV CH-1 on the EX-800 will enable it to receive and play the POLY-800's keyboard data. Selecting RCV CH-2 will allow the EX-800 to play the POLY-800's Sequencer note data. Selecting channels 3 thru 16 will allow the EX-800 to receive BOTH Keyboard and Sequencer note data from the POLY-800. The selected MIDI channel number is maintained when power is turned off and on again.

RECEIVING CHANNEL	VALUE
CH-16	16
↓	↓
CH-1	1

86 PROG CHANGE (Program Change)

A MIDI equipped synthesizer (such as the POLY-800), remote keyboard, or personal computer can be used to select different EX-800 programs. For example, if connected to a POLY-800, both synthesizers can change program numbers together. The best use of this function is to arrange the programs on both synths so that they match the order in which desired programs will be selected during performance.

To enable the external program select function, the value of the PROG CHANGE parameter (86) must be set to "1" (enabled).

The value of this parameter is reset to "0" (disabled) when the EX-800's power is initially turned on.

PROG CHANGE	VALUE
Program change	1
No change	0

87 BEND

The EX-800 can respond to pitch bend data received from a MIDI equipped remote keyboard or synth. For example, if you use the joystick to bend up on the POLY-800, then the EX-800 pitch will also bend up. However the amount that the pitch bends on the EX-800 will depend on its BEND parameter value. At 0 there is no bend. This can be set to any value from 0 to 64. At the maximum value, pitch can change up to perfect fifth (± 700 cents).

BEND	VALUE
Pitch bend width	
Wide	64
↓	↓
Narrow	1
None	0

88 SEQ CLK (Sequencer Clock)

This parameter determines whether EX-800 sequencer timing will be controlled by its internal clock or by an external unit via MIDI. This parameter's "default" value is 1 (Internal clock) when the EX-800 is first turned on.

SEQ CLK	VALUE
External clock	2
Internal clock	1

4. CREATING SOUNDS

New sounds are created on the EX-800 by changing or EDITING old programs. Since the Digital Control system provides complete, detailed information about all programs in memory, no Manual mode (found in older synthesizers) is needed.

4.1 OVERVIEW

To create a new sound, first select one of the 64 existing programs that's close to what you want (if no program is close, any program may be used as a starting point). Next, select individual parameters of that program (from the Parameter Table) and edit them, one at a time, until the sound matches your mental image as closely as possible. By adjusting the various parameters, you can create virtually any type of sound you want.

The sound created at this point is a TEMPORARY edit of the original program.

The original program is still in memory, and the temporary edit will be ERASED if you reselect the original program or select a new program.

- To make the temporary edit PERMANENT, you must WRITE the edited program into one of the 64 Program Numbers (the program memory).
- The same Program Number can be used (erasing the original program), or a different Program Number can be used (saving the original program, but erasing a different one).

The procedures for creating sounds and storing them in memory will now be described in detail.

MEMORY BACKUP

- Sound and sequencer program data stored in EX-800 memory are protected by a built-in battery powered circuit so that they will not be lost or erased when power is turned off. Under normal conditions (0~40°C) the battery will protect memory for more than five years from the data of manufacture.

If you find that memory contents are lost after turning off the power and then turning it on again, please contact your nearest KORG dealer distributor or service center.

NOTE:

You can also use the procedures below for "fine tuning" sounds to compensate for room acoustics, amplifier characteristics, etc., as well as for creating new sounds.

4.2 EDITING PROGRAMS

4.2.1 Select a Program

Select a sound from the program memory that resembles the kind of sound that you want (or choose any sound). Using the

Number Select Buttons (see section 2, Selecting Programs, if you're not sure how to do this).

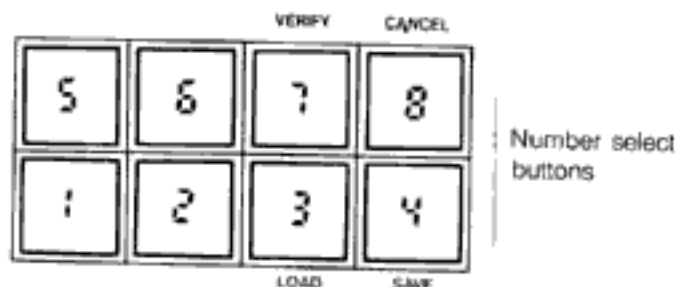

4.2.2 Select Parameter Mode

Press the PROG/PARA switch to select Parameter Mode.

The middle two digits show the current PARAMETER NUMBER, and the right two digits show the current VALUE of the Parameter.

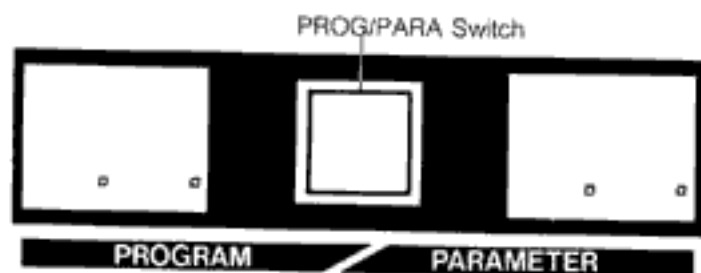

4.2.3 Select a Parameter

All Parameters are referred to by a two digit number ranging from 11 to 88 (just like Program Numbers).

Look up the number of a Parameter that you think should be changed in the Parameter Table, and enter it using the Number Select Buttons (1-8).

EXAMPLE: Selecting VCF Cutoff (41)

By looking in the Parameter Table, you'll find that all the VCF parameters start with the number '4', and that VCF Cutoff is 41.

1. First, press Number Select button 4.
The DISPLAY will show something like the following:



- A horizontal line appears until you select the next digit (which means the programmer is waiting for an input).
 - If the first digit selected was wrong, simply press the 'V' button TWO times, so that the number 'V' appears in the left hand digit of the Parameter Number Display.
2. Next, push the Number Select button : . The VCF Cutoff Parameter has now been selected.

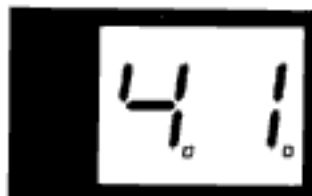

PARAMETER

NOTE:

If you enter numbers that are not in the Parameter Table (28 or 35 , for example), the number will be accepted but the VALUE section of the Display will be blank. This will also happen if you try to access DCO 2 or DEG 2 parameters in WHOLE Mode (they are only available in DOUBLE Mode).

4.2.4 Edit the Parameter

The UP and DOWN switches in the Value section are used to change the Value of the selected parameter. The current value of the parameter is shown in the VALUE section of the Display:

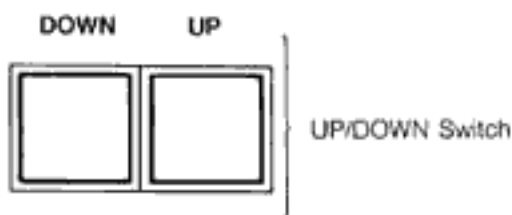

VALUE

The dot is lit.

Press the UP button to INCREASE the value; press the DOWN button to DECREASE the value. If you press and release either of these buttons quickly, the value will change one step at a time. If you keep either button depressed, the value will increase or decrease rapidly after a short pause.

NOTE:

If the VCF Cutoff Value is reduced to near 0 , the volume of the sound will also be reduced.

When you select a Parameter and then change it, a small LED dot will turn on in the lower right corner of the VALUE Display.

This dot shows that the parameter Value has been changed; if you restore the parameter to its previous Value, the dot will go out. However, if you leave the new value in place (LED dot is on), select another parameter, and then reselect the first (altered) parameter — the LED dot will NOT turn on.

The LED dot only shows when a Parameter has been changed since you selected it. It DOESN'T tell you whether or not the Parameter Value is the same as in the original ("permanent") program being edited.

4.2.5 Edit the Remaining Parameters

After editing one parameter to your satisfaction, repeat steps 3 and 4 for the next parameter, and so on. Continue editing parameters (re-editing if necessary) until the desired sound is achieved.

- If you don't like the edited sound, you can cancel ALL of the edits and restore the original programmed sound. Just press the PROG/PARA switch to select Program Mode, and re-select the original Program Number.
- To make the edited version PERMANENT, you must write it into memory (see Section 4.3 below).

4.2.6 Using the BANK HOLD Feature

The BANK HOLD feature allows the current Parameter Bank number (left hand digit of the Parameter Display) to be "held". This enables you to select any of the Parameters in that bank with a single press of a button, for easy editing of a particular Poly-800 Module.

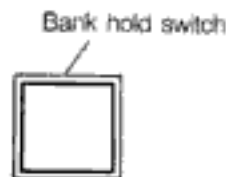

BANK HOLD

EXAMPLE: Editing the VCF Parameters

- Select any VCF Parameter (such as Cutoff, V) as explained above, and then press the BANK HOLD switch. The Display will show the following:



PARAMETER

The dot is lit.

- You may now select any of the VCF parameters by pressing one of the Number buttons. For example, press '3' to select KBD TRACK, '5' to select EG INT, and so on. You may also press 'g' to select the Chorus ON/OFF Parameter. (Pressing 'γ' will result in a blank VALUE Display.)
- Press BANK HOLD again to cancel the Bank Hold function and return to the normal two-digit selection method.

4.3 WRITING PROGRAMS TO MEMORY

To make any edited or newly created sound PERMANENT, you must write it into one of the 64 Program Numbers in the memory (1-88).

Sound data stored in memory is protected by a back-up battery circuit so it will not be erased even if power is disconnected from the EX-800.

NOTE:

You can only WRITE the currently selected sound to memory. If you have already reselected the original version, the edited version is lost.

MEMORY WRITE PROCEDURE

- Set the Program Write switch on the rear panel to the ENABLE position.

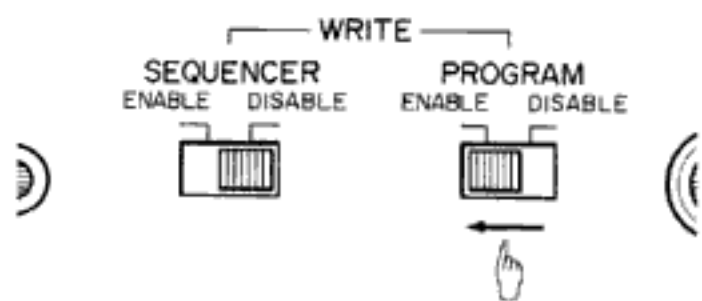

- Make a mental note of the current Program Number, if you want to write an edited version "over" the original program.

- Press the WRITE button. The Program Number in the Display will be replaced by a pair of flashing lines, to show that you are in Write mode.



- Press the Number buttons to select the Program Number where you want to store the edited sound.

EXAMPLE:

To store the edited sound in Program Number 34, press the Number Select buttons 3 and then 4. After button '3' is pressed, the DISPLAY will show the following:

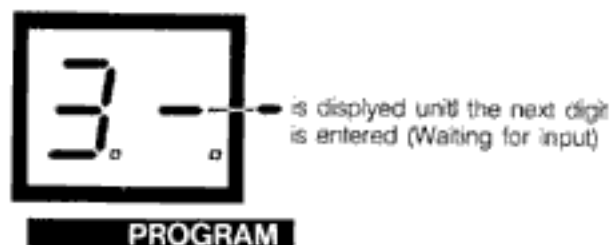

NOTE:

At this point (before the second button is pressed), the "old" sound in memory is still unchanged. If you pressed the wrong number for the first digit (AND ARE ABOUT TO ERASE THE WRONG PROGRAM):

- Switch the rear panel Program Write switch to the DISABLE position.
- switch it back to the ENABLE position
- press WRITE button again
- then press the correct Number buttons ('3' and then '4')



The edited sound is now stored in Program Number 34.

- Set the rear panel Program Write switch to the DISABLE position.

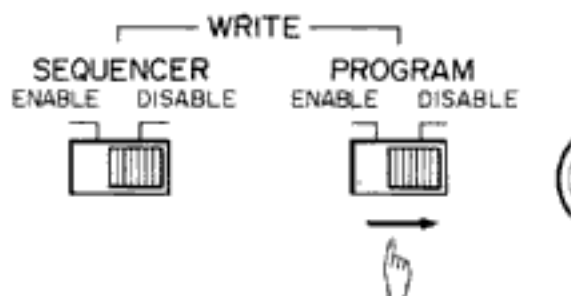

NOTE:

Protecting Memory
After WRITING a program to memory, it's a good idea to always set the Program Write switch to DISABLE. This prevents accidental erasure or change of your programs (and, of course, doesn't interfere with selecting programs at all).

IT'S ALWAYS A GOOD IDEA TO SAVE YOUR PROGRAMS ON TAPE FOR FURTHER PROTECTION (see Section 7).

4.4 MOVING PROGRAMS

Programs in memory may be easily copied or moved from one Program Number to another, the basic procedure is:

- select the program you want to copy
- press the red WRITE button
- enter the Program Number that you want to copy the program into

4.4.1 COPYING A SINGLE PROGRAM

1. Set the rear panel Program Write switch to ENABLE.

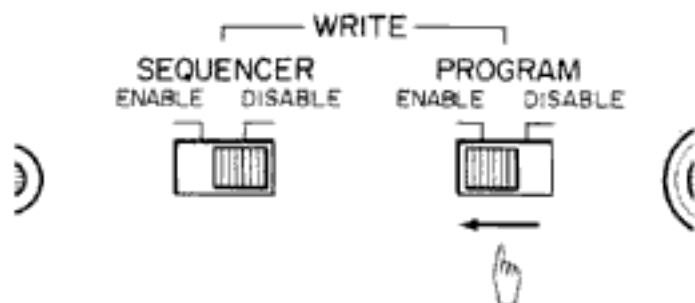

2. Select the program you want to move, using the Number buttons.

EXAMPLE

If you want to move the sound in Program Number 11 to a different program number, press the PROG/PARA button (if necessary) to select Program mode (so that only three digits are showing in the Display). Then, select Program Number 11 in the normal way.

3. Press the WRITE button. The typical blinking Display should result.

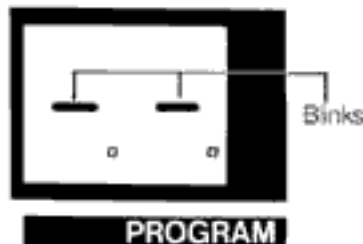

4. Select the destination Program Number (where you want to copy the program you selected in step 2).

EXAMPLE

To copy the program to Program Number 23, enter '23' using the Number buttons.



- A horizontal line appears after the first digit is selected (which means the programmer is waiting for an input).
- If you pressed the wrong number for the first digit (AND ARE ABOUT TO ERASE THE WRONG PROGRAM):

- switch the rear panel Program Write switch to the DISABLE position, and switch it back to the ENABLE position
- reselect the program you want to copy, then press the WRITE button again
- finally, press the correct Number buttons ('2' and then '3')

When the program has been copied to Program Number 23, the Display will show the following:



At this point, the sound originally stored in Program Number 23 has been erased, and the same sound is stored in two Program Numbers, 11 and 23.

5. Set the rear panel Program Write switch to the DISABLE position.

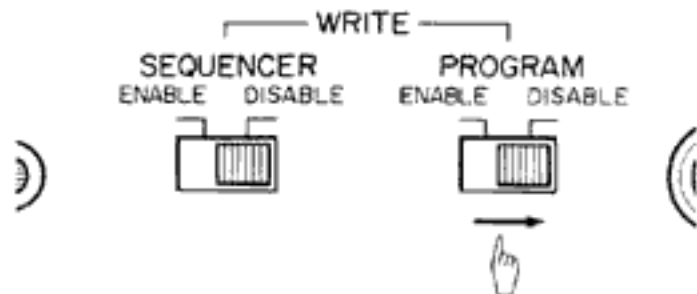

4.4.2 MOVING SEVERAL PROGRAMS

It's often convenient to rearrange a number of programs into the order you want to use them in for performance. As an example, assume that you want to use programs 42, 55, 13, 13, 11 and 83 for a particular song, in that order.

1. Select a "free" location (for example, 54).

NOTE:

To move programs, you must have at least 1 "free" Program Number which holds a program YOU DON'T MIND LOSING. If there are no free locations, write down all the parameter values for one program, use that Program Number as the "free" locations, and re-enter the parameter values you wrote down after you finish moving programs into their final order.

- 
2. Pick a Program Bank to contain the sequence of programs (for example, Bank 4).
 3. Since you don't want program 41 in your sequence, copy it into the "free" location (84) as described above. This opens up Program Number 41 for the first program that you DO want.
 4. Copy program 42 into 41. This opens up location 42.
 5. Copy program 85 into 42. This opens up 85.
 6. 43 is full, but it's not what you want. Copy 43 to 85, then copy 73 to 43. Now, 43 is what you wanted, the OLD program in 43 is safe in 85, and 73 is open for further moves.
 7. Continue this process by moving 44 to 73, 13 to 44, 45 to 13, 11 to 45, and 46 to 11, and 83 to 46.

Now, the six programs you wanted are all in Bank 4, in the proper order — and the six programs that were there before are safe, but scattered all through Program Memory. If you like, you can keep on in this manner until every program is exactly where you want it to be.

- After all programs have been moved as desired, return the rear panel WRITE switch to the DISABLE position.
- You can use the Tape Interface to save many different arrangements of programs, for different songs or sets of songs.
- Once the programs are organized in this way, you can use the PROG UP footswitch to easily move through the programs.

5. PERFORMANCE FEATURES

The EX-800 provides many useful performance features, including the Tune control, Polyphonic Sequencer; and Program Up footswitch.

5.1 TUNE

Adjusts the basic pitch of the EX-800 to match other instruments. Turning the knob towards “#” raises the pitch; turning it towards “b” lowers the pitch.

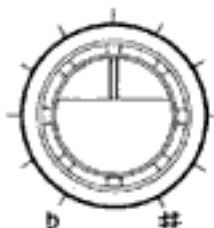

TUNE

5.2 SEQUENCER

The EX-800 has a built-in polyphonic sequencer which can memorize a sequence of up to 256 “events” from a MIDI equipped remote keyboard or synth such as the POLY-800. If a monophonic sequence of notes all the same length is recorded, up to 256 notes can be stored and played. If chords and/or rests are included in the sequence, then each note in the chord or rest will be one event, reducing somewhat the total step capacity.

You also have the option of WHOLE or DOUBLE modes for the DCOs. If you want to include chords of up to eight notes then set the EX-800 to the WHOLE mode before starting to program the EX-800 sequencer. Likewise, set to the DOUBLE mode beforehand if you want 4-voice operation.

5.2.1 TIMING VALUES

The EX-800 Sequencer is a STEP TIME Sequencer.

- A STEP is a basic time unit, which is usually the same as the shortest note or rest in the sequence.
- It doesn't matter how long you hold down notes when you're recording a sequence. All notes will be played back with the same length. So, if you play a line using quarter notes, eighth notes, etc., it will be played back as all eighth notes — unless you use the STEP button to make some notes longer than other ones.

To have notes with different time values, you must TIE two or more steps together for each of the longer notes, using the STEP switch.

For example, assume you want to record a song that uses 16th notes, half notes and everything in between.

- A 16th note is the smallest time value, so it only requires 1 “step” (the smallest amount of time the sequencer recognizes).
- A half note equals eight 16th notes, and therefore lasts for 8 steps.
- Notes in between use smaller amounts. An 8th note = 2 steps; a quarter note = 4 steps, and so on.
- Rests are just “silent notes”, so they take up the same number of steps as notes (8th rest = 2 steps, etc.).
- To work with triplets, you must use a different set of step values. A triplet 16th note would be 1 step, but an 8th note would be 3 steps, a quarter note 6 steps, etc. (2 steps would now be a triplet 8th note).

By doing a little planning before recording your sequence, you can work with almost any set of timing values.

5.2.2 MEMORY CAPACITY

- The Sequencer can record up to 256 “events”. If you're recording a monophonic bass line where all notes are the same length, you can have up to 256 notes or rests in a row in your sequence (at 1 event per note or rest).
- Each note of a chord is recorded as a separate “event”, so a four note chord requires 4 events (even though it all happens during 1 “step's” worth of time). A sequence made up only of 4 note chords could hold up to 64 chords (256 events/4 events per chord) before you ran out of memory, and it would last for 64 steps.
- TIED NOTES (see above) or chords take up 1 event per note plus 1 event for each step which extends the length of the chord. A four note chord TIED to last for 4 steps (i.e. a quarter note, if a 16th note=1 step), will take up 7 events. (That breaks down to 4 events for the 4 note chord on the 1st step, plus 1 event each for the extensions to the 2nd, 3rd and 4th steps).
- Rests take up 1 event per step — so a quarter rest would take up 4 events (and 4 steps) with a 16th note = 1 step.

5.2.3 WRITING A SEQUENCE

1. Preparations

- 1 Connect EX-800 MIDI IN jack to MIDI OUT jack of keyboard that you will be using to play the notes to be memorized by the EX-800 sequencer.

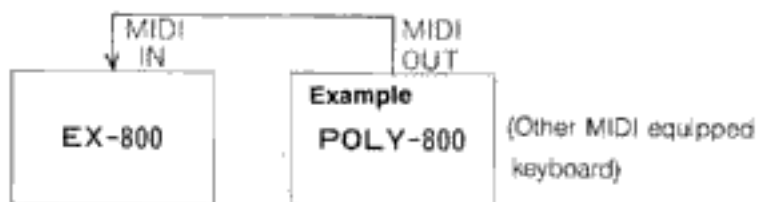

- 2 Set the rear panel SEQUENCER WRITE switch to the ENABLE position.

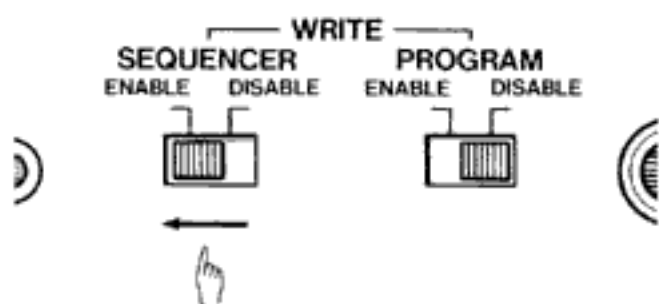

- 3 Press the Sequencer START/STOP button. The DISPLAY will show the following:



"S 01" stands for "Sequencer Mode, Step #001".

You can record up to 256 steps.

2. Writing a Note

Play the note and release it. When you release the note, the Step Number Display will increase by 1, showing that the note is recorded with a length of 1 step.

3. Writing a Chord

Play the chord, either all notes at once, or adding notes (for chords with large intervals) while keeping at least one key depressed all the time. The chord will be recorded (with a length of 1 step) when all keys have been released.

4. Writing a Tied Note or Chord

While holding down the key(s) for the note or chord, reach over and press the STEP switch once for every step you want to add to the length of the note (chord). Then, release all of the keys. For example, to record a 'C' chord that is four steps long:

- play and hold the 'C' chord
- press the STEP switch THREE times (the Step Number Display increases by 3 numbers)
- release the 'C' chord (the Step Number increases by 1 more number, for a total length of 4 steps).

5. Writing a Rest

Press the STEP button once WITHOUT playing any keys to insert a rest that's 1 step long. Press STEP several times to insert longer rests.

6. If You Make a Mistake

Press the START/STOP key to delete the last step you entered. If the mistake happened earlier (or if it's longer than 1 step), press START/STOP several times, until the Step Number Display shows a number before the mistake occurred.

7. Ending the Sequence

Return the rear panel SEQUENCER WRITE switch to the DISABLE position to end the sequence and leave the Record mode.

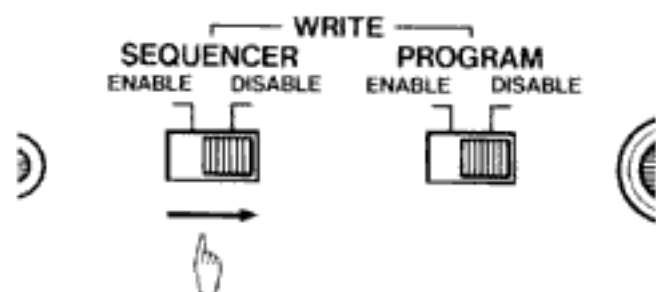

8. Reaching the End of Memory

The Sequencer can record up to 256 events (see MEMORY CAPACITY, above). When all the memory has been used up, the Sequencer will automatically leave the WRITE mode (showing the same Display as 6, above).

Make sure to set the rear panel SEQUENCER WRITE switch to the DISABLE position if this happens. Otherwise, pressing the START/STOP switch will erase your sequence and start recording a new one from Step #1.

WRITING A SAMPLE SEQUENCE

For practice, try writing the following musical passage into the sequencer:



Since the smallest time value is a 16th note, and no triplets are used, you can use time values of 16th note = 1 step; 8th note = 2 steps, and dotted 8th note = 3 steps.

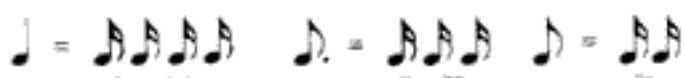

1. Put the Sequencer into WRITE mode as described above.
2. Play 'G' (above middle C), hold it, press the STEP switch once, and release the key, to enter 'G' as an 8th note. The Step Number Display should now read "5003" (S# = 003).

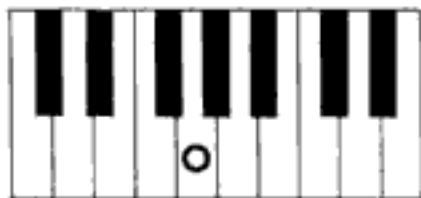

3. Play and hold 'A', press STEP once, and release the key to enter "A" as an 8th note (S# = 005).

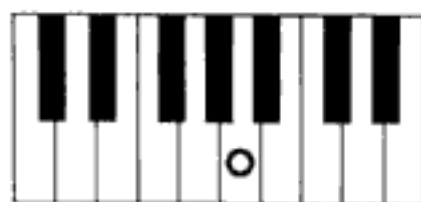

4. Press the STEP switch four times, without holding any keys down, to insert a quarter rest (S# = 009).
5. While holding down a chord ('F', 'A', 'C', 'E'), press STEP twice and then release the keys, to enter the chord with a length of a dotted 8th note (a "dotted 8th chord") (S# = 012).

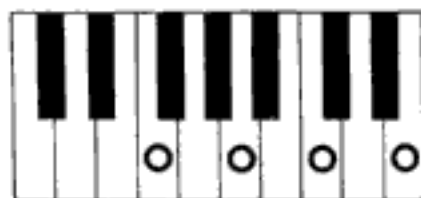

6. Play the chord ('F', 'A', 'C', 'E') again and release it, to enter it as a "16th chord" (S# = 013).
7. Press the STEP switch four times, without holding any keys down, to insert a quarter rest (S# = 017).
8. While holding down a chord ('F', 'A', 'B', 'E'), press STEP twice and then release the keys, to enter as a "dotted 8th chord" (S# = 020).



9. Play the chord ('F', 'A', 'B', 'E') again and release it, to enter a "16th chord" (S# = 021).
10. Press the STEP switch twice by itself, to insert a 8th rest (S# = 023).
11. Play 'G' and press STEP once to enter an 8th note (S# = 025).



12. Play 'A' and press STEP once to enter an 8th note (S# = 027).

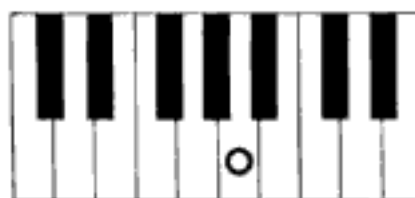

13. Play 'C' and press STEP once to enter an 8th note (S# = 029).



14. Play 'D' and press STEP once to enter an 8th note (S# = 031).



15. Play 'E' and press STEP once to enter an 8th note (S# = 033).



This completes writing the Sequence. Return the rear panel SEQUENCER WRITE switch to the DISABLE position.

- If you made any mistakes while writing the sequence, you can correct them using the START/STOP button as described above.

5.2.4 PLAYING BACK A SEQUENCE

1. Press the START/STOP switch once to begin playback.

As soon as the sequence reaches the end of the last note or rest you programmed, it returns to the beginning and repeats again.

The front panel SPEED slide control adjusts the rate at which the sequence plays back, over a wide range.

NOTE:

The sequencer can also be clocked over the MIDI bus (see Section 6, MIDI, P.31). In this mode, 6 MIDI clocks are equal to 1 sequencer step. Since MIDI clocks occur at a rate of 24 clocks per quarter note, each sequencer step = one 16th note when the sequencer is clocked by MIDI.

- When the Sequencer is set for an EXTERNAL (MIDI) clock (parameter #88), the front panel SPEED and START/STOP controls have no effect.

2. Press the START/STOP switch again to stop playback of the sequence.

5.3 PROGRAM UP FOOTSWITCH

The rear panel PROGRAM UP jack allows you to advance one program at a time (from program #11 to #12, for example) by using a footswitch or other "trigger" source. When the end of a particular Program Bank is reached, triggering the PROGRAM UP jack will go the beginning of the NEXT Bank. When the end of the LAST Program Bank is reached, triggering PROGRAM UP will select the FIRST Program #:

- With Program #28 selected, triggering PROGRAM UP selects #31
- With Program #88 selected, triggering PROGRAM UP selects #11

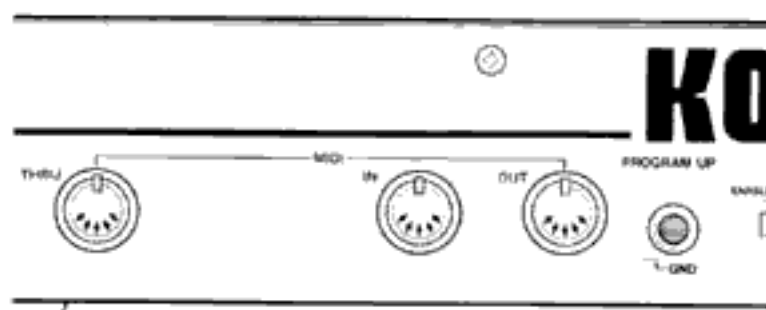

KORG footswitch PS-1 (optional)



Connecting a footswitch (optional) to the PROGRAM UP jack allows you to keep both hands on the keyboard while changing sounds instantly, whenever desired.

- A FOOTSWITCH (KORG PS-1, S-1 etc.) is normally connected to the PROGRAM UP jack on the rear panel.
- A short-to-ground type trigger output (\perp GND) from a rhythm or other device can also be connected, to synchronize program changes to an outside source.

6. MUSICAL INSTRUMENT DIGITAL INTERFACE (MIDI)

MIDI is an acronym for MUSICAL INSTRUMENT DIGITAL INTERFACE which is an internationally agreed upon standard way of enabling interconnection and communication between synthesizers, sequencers, rhythm machines, and personal computers.

The cable used for MIDI connections must be a 5-pin DIN cord no longer than 15 meters.

6.1 MIDI IN

The EX-800 is an add-on synthemodule without an integrated keyboard. To use it you need to connect its MIDI IN jack to the MIDI OUT jack of something that can send data about which notes are to be sounded and how. A remote keyboard, MIDI equipped synthesizer (such as the POLY-800), sequencer, or personal computer (with appropriate interface and software) may be used for this purpose. MIDI data that can be received by the EX-800 is limited to the following:

1. Key data (Pitch, on/off Timing).
2. Pitch bend (up & down).
3. Modulation (DCO, VCF).
4. Sequencer (clock, start/stop).
5. Program change.
6. Volume.
7. Memory Transfer request (dump, reload).
8. Active Sensing

Data other than the above will be ignored by the EX-800.

6.2 MIDI OUT

Used to transfer EX-800 memory contents to external computers and other devices. Only the following data can be outputted:

1. Contents of EX-800 memory.
2. Data Error condition.

6.3 MIDI-THRU

The MIDI-THRU jack directly copies and outputs all data received by the unit's MIDI-IN jack without modification. By using the MIDI-THRU jack, you can expand your system with up to four additional synthesizers, expander modules, rhythmers, etc. and ensure that all units connected receive the same MIDI information at the same time.

For timing reasons, instruments connected in this manner should be limited to four, or possible malfunction may occur. More than four instruments should be connected using a "MIDI Through Box".

6.4 MEMORY TRANSFER

The Memory Transfer function enables external storage and manipulation of the EX-800's program and sequencer data by a personal computer or other device connected to the MIDI IN and OUT jacks.

There are no controls on the EX-800 for this purpose. The transfer request is made by the external computer through the EX-800 MIDI IN jack. When the EX-800 receives such a request, it "dumps" all data from its memory out the MIDI OUT port. (See MIDI IMPLEMENTATION section at the end of this manual for data formats and other information.)

Data included are:

1. MIDI Receive channel.
2. Sequencer note data.
3. Chord memory.
4. Bend Depth.
5. Program data.

When the EX-800 gets a data transfer request, it takes about one second to send the data. During this period, all normal functions cease, including the display.

You can also download from an external computer to change the EX-800 memory contents. The external computer issues a memory reload command to the EX-800, followed by the memory data. During this time (normally approximately 1 second) all normal functions cease, including the display. If received data is erroneous, then the EX-800 will send a data transfer error message out the MIDI OUT port.

6.5 TYPICAL CONNECTIONS

1. Using the POLY-800 or other MIDI synth to control the EX-800.

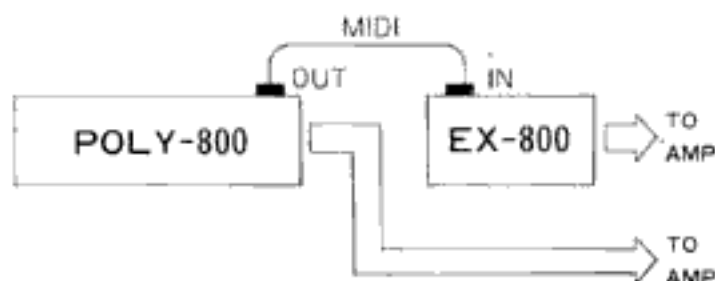

Connect MIDI synth's MIDI OUT to EX-800's MIDI IN jack using a MIDI cable (5-pin DIN cord). Connect the audio signal outputs of both units to amp or mixer inputs. When the EX-800 is connected together with POLY-800 above diagram, notes played on POLY-800 are duplicated by EX-800. Program number changes (when enabled on EX-800 [parameter 85 = 1]), sequencer data, joystick data and "mode messages" can also be sent from POLY-800 to EX-800.

POLY-800 (the transmitting keyboard) ALWAYS transmits keyboard note data on channel "1", and sequencer note data on channel "2", regardless of the setting of its Receive Channel Parameter (parameter "85"). Thus, EX-800 may receive note data from POLY-800's keyboard, sequencer, or BOTH, depending on EX-800's mode and Receive Channel settings. When the synths are first turned on, EX-800 will initially receive data on ALL MIDI channels (called the "OMNI On" mode). If the sequencer on POLY-800 is started (and EX-800 is set to Receive Channels 1 or 2), then a message is sent EX-800 so that EX-800 will receive data only on one channel (called the "Multi-channel" or "OMNI Off" mode). The receive channel last selected by the user will be retained, even when power is turned off; therefore, the user may have to select a different channel, depending on the function desired (see below).

(1) RCV CH-1:

EX-800 responds to POLY-800 keyboard data, program change data, joystick data, and mode messages.

(2) RCV CH-2:

EX-800 responds only to POLY-800 sequencer data and mode messages.

(3) RCV CH-3 through 16:

EX-800 responds to all data except mode messages.

This kind of connection does more than simply enable playing the EX-800 from the sending synth (POLY-800) keyboard. It lets you obtain different sounds from both units while reproducing the outputs in different parts of a stereo array.

- Note number data "36-96" (MIDI) can be received. This corresponds to 61 keys from C₂-C₆ on a Keyboard.
- If key data outside this range is received it will be sounded as the nearest note of the same name.

Key data response range:

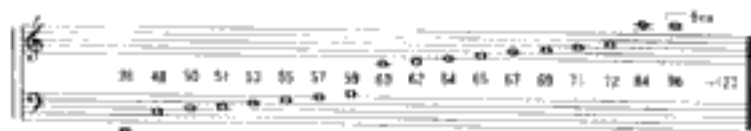

2. Using a remote keyboard to control the EX-800.

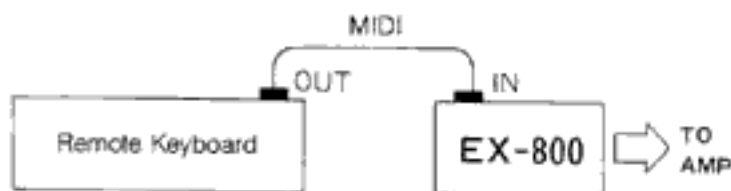

Use a MIDI cable to connect remote keyboard MIDI OUT jack to EX-800 MIDI IN jack. As in the previous example, there is no need to select RCV CH on the EX-800. The EX-800 will respond to keyboard data, pitch bend data, VCF modulation data, program change and other data from the remote keyboard.

This sort of arrangement is suitable for working with a remote keyboard on a shoulder strap, in which case a locking mechanism on the MIDI cables may be used to prevent accidental unplugging.

3. Synchronized performance between POLY-800 sequencer and EX-800 sequencer.

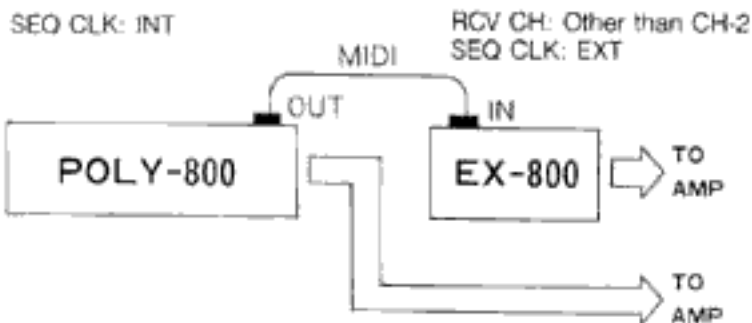

Write sequences with the same number of steps into both the POLY-800 and EX-800. Set POLY-800 SEQ CLK (parameter 88) to value 1 (internal). Set EX-800 RCV CH to 1 or 3-16 (any value except 2) and set SEQ CLK to value 2 (external). Press START/STOP key on the POLY-800 to begin synchronized playback on both units. (Typically you could have the POLY-800 playing chords while the EX-800 played a bass line.) Or you could have a MIDI equipped rhythm machine controlling EX-800 sequence timing. In this case, each step on the sequencer will be synchronized with an eighth note so be sure to write the sequence data with this in mind.

4. Using a MIDI equipped digital sequencer to control the EX-800.

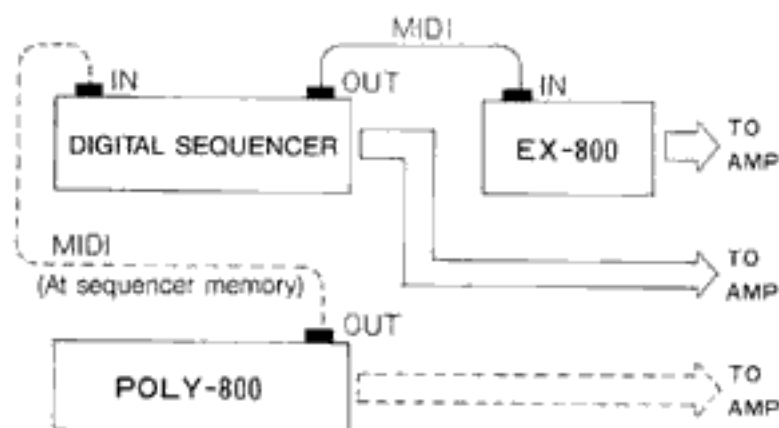

A MIDI equipped synthesizer such as the POLY-800 is used to input key data to the digital sequencer. The POLY-800 can then be disconnected from the digital sequencer (broken line). Decide beforehand whether you are going to use the EX-800 in the 4-voice or 8-voice (DOUBLE or WHOLE) mode and input data accordingly. If the digital sequencer is a multi-track model then be sure to set EX-800 RCV CH value to the appropriate channel number (1 - 16) after turning on EX-800 power.

(Refer to the digital sequencer's owner's manual for particular details.)

(The number of notes storable and played varies according to the software being used. Also, please remember that the EX-800's "DCO-MODE" parameter (parameter # 18) controls how many notes each EX-800 can sound simultaneously (either 4 or 8), and care should be taken to select programs with sufficient notes capabilities for the desired music.)

For timing reasons, instruments connected via the MIDI-THRU jacks should be limited to four, or possible malfunction may occur. More than four instruments should be connected using a "MIDI-Through Box".

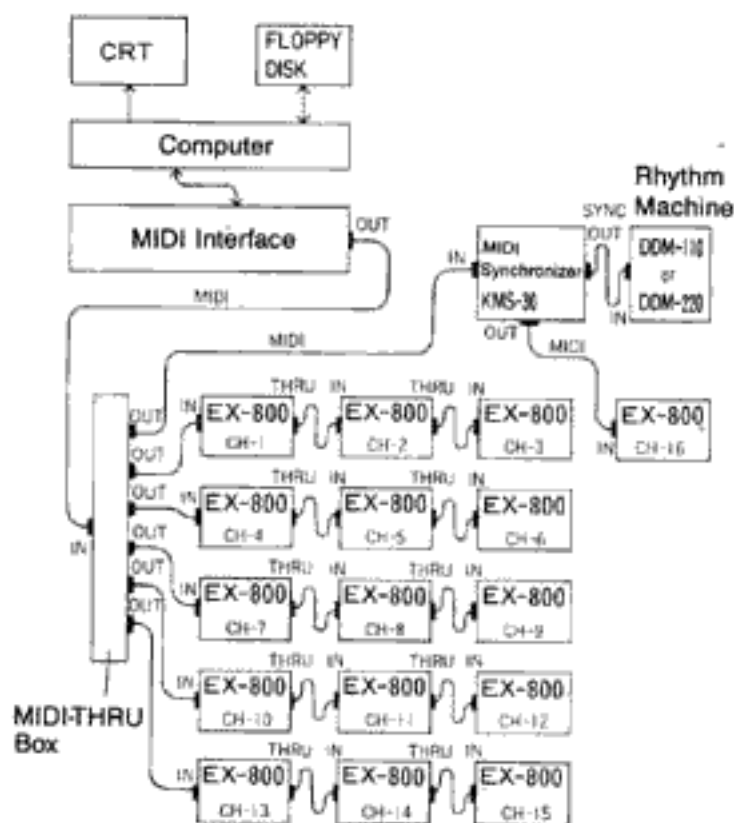

In this system, full use is made of MIDI channels 1 through 16 via use of a MIDI "Through Box". Furthermore, a MIDI Synchronizer device (KORG KMS-30) is used to synchronize the timing of rhythm machines (e.g. KORG DDM-110, DDM-220, KPR-77, and other device with "Sync" connection) to the sequencer. The KMS-30 can also be used to perform a "Sync to Tape" function for driving all synthesizers, rhythmers etc. from one track of the tape recorder.

This type of system makes it possible to perform music with complex arrangements and orchestrations.

NOTE:

When an EX-800 is first turned on, its mode is set to receive data on all channels. However, if you are going to use several EX-800s (other MIDI synths, drum machines, and so on) under the control of a multi-channel sequencer or computer, then it is necessary to send mode messages to the EX-800s to change them to the MULTI CH mode. If the sequencer or computer can not send such messages then selecting the 88 parameter number will automatically change to the MULTI CH mode.

To get out of this mode you can turn the Ex-800 off or send it a mode message to return to its default condition.

5. How to use a personal computer with commercially available software to control the EX-800

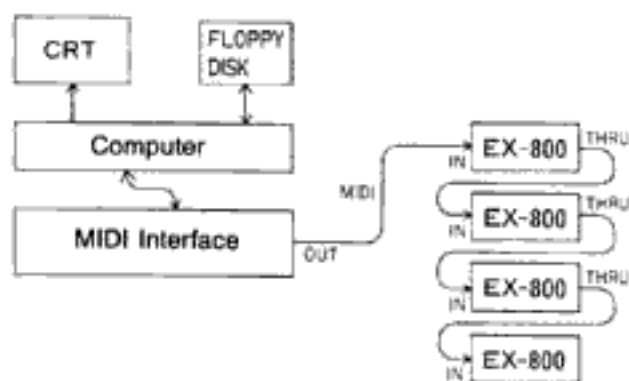

This is an example of a system using a "personal computer" with a MIDI Interface device, and commercially available software to automatically play four EX-800 Modules. The data is written into the computer's memory in accordance with the respective software's instructions, and is saved on tape or Diskette. The finished piece is then played back by the four EX-800s, under the computer's control.

7. TAPE INTERFACE

The Tape Interface lets you SAVE the contents of both the Program Memory and the Sequencer data onto cassette tape at the same time. You can then LOAD either Program data, Sequencer data, or both from the tape into the EX-800, whenever desired. The DISPLAY shows up to six different messages to keep you constantly informed of tape operations and possible problems. Loading is so fast (14 seconds) that you can even load new data between songs during a performance. The Tape Interface allows a library of many original sounds to be easily created and used.

NOTE:

- The EX-800 and Poly-800 can use the same data.
- MIDI section parameter 85 (RCV CH) and 87 (BEND) data can be saved to tape or loaded to memory; other MIDI parameter values can not. Parameter 85 and 87 values remain the same regardless of which program number (1-88) is selected.

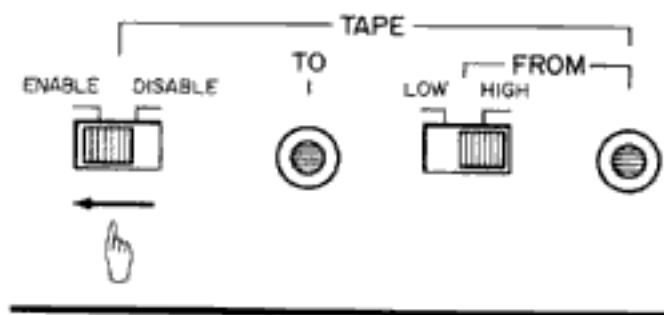

To use the Tape Interface, set the rear panel TAPE switch to the ENABLE position. The functions of the Number Select buttons '3', '4', '7' and '8' will change as follows:

		VERIFY	CANCEL
5	6	7	8
1	2	3	4
		LOAD	SAVE

• SAVE (4)

Press this button to store both Program memory and the Sequencer data on tape.

• LOAD (3)

Press this button to load recorded Program and/or Sequencer data back into the EX-800.

After data is LOADED, the previous contents of the Program memory and/or Sequencer will be erased.

• VERIFY (7)

This is used to check recorded data (after the SAVE procedure) to make sure that it is properly recorded on tape.

• CANCEL (8)

If an error occurs during the LOAD or VERIFY operations, the CANCEL button lets you start over again. Pressing CANCEL during SAVE, LOAD, or VERIFY operations will immediately cancel the operation.

7.1 SAVING PROGRAM & SEQUENCER DATA ON TAPE

1. Connect rear panel TO TAPE jack to the tape recorder input jack (MIC jack recommended).

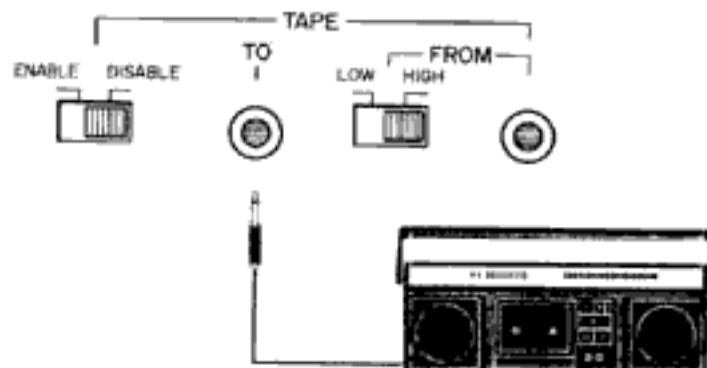

- MIC inputs commonly use either "mini" or standard phone type jacks. Use the optional accessory connecting cord and adaptor (as needed) to connect the cassette tape recorder.
- The EX-800 Tape Interface is designed to be used with medium to good quality portable cassette recorders and cassette tapes. "Bargain basement" tape brands will generally causes problems, and "Walkman" type recorders & micro-cassette units may not have a sufficiently high output level.

2. Set the tape recorder to the Record mode, and let the tape advance until the leader tape is past the tape heads. Then press the recorder's PAUSE button.

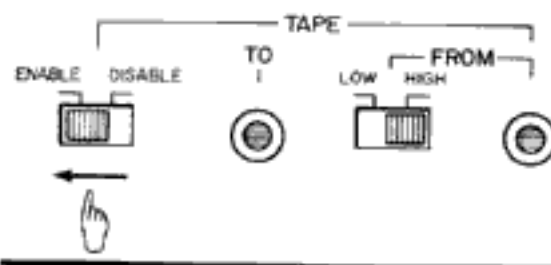

- Set rear panel TAPE ENABLE/DISABLE switch to the ENABLE position. The DISPLAY will show this message:



- The EX-800 will now produce a "level setting" test tone at the TO TAPE jack (a medium pitched "ooo" sound). Using this tone, adjust the Record Level (Volume) setting on the tape recorder so that it is about 30 per cent lower than the level at which the signal distorts.

- If the recorder has VU tape meters, adjust the record level control to obtain a reading around -5dB.

VU Meter

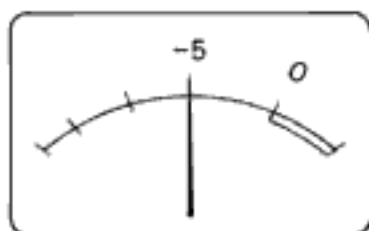

- When the recording level adjustment is completed, release the PAUSE button to begin recording. (You may want to record a short verbal message describing the program contents before you begin recording the actual data.)
- Press the SAVE button to begin transferring the Program and Sequencer data on the EX-800 to the tape recorder.

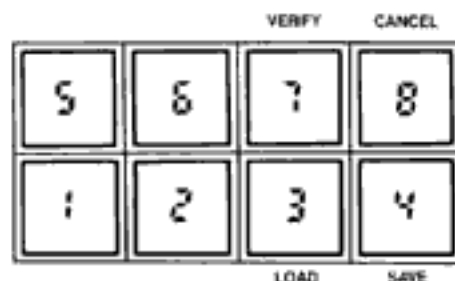

What you see on the display



- After about 14 seconds, the DISPLAY will change from SAVE to TAPE, and you should stop the tape recorder (if you're done making "safety" copies). All data has now been recorded on the tape.

- To guard against accidental loss of your data, it's a good idea to repeat Step 6 several times to make "safety" copies of your data. Leave a five-second gap between recording so that you can find the beginning of each recording easily.

- Return the rear panel TAPE ENABLE/DISABLE switch to the DISABLE position.

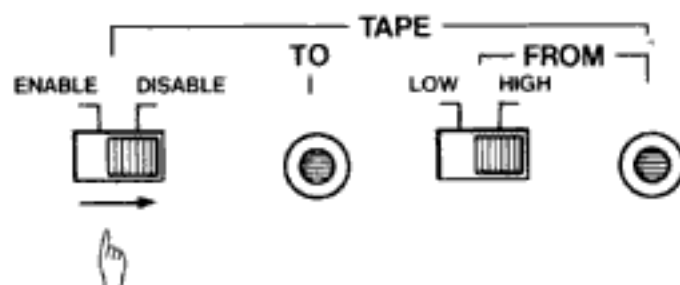

7.2 RECORDED DATA TONES

If you listen to a tape of recorded data, you will hear the following tones;

Level set tone (lower-pitched "ooo")

Leader tone (high-pitched "eee")

Data tone (medium-pitched "aaa")

End tone (high-pitched "eee")

Level set tone (lower-pitched "ooo")

Leader tone indicates the beginning of the SAVE operation.

Data tone The actual digital data from the EX-800 Programmer and Sequencer.

End tone indicates end of the SAVE operation.

7.3 VERIFY

The VERIFY procedure should always be used after SAVE to make sure that the Program and Sequencer data has been recorded properly. It is also useful for determining the best playback level to use with your tape recorder.

- Connect EX-800 rear panel FROM TAPE jack to the tape recorder output jack (EARPHONE or LINE OUT). Set FROM TAPE switch to HIGH (earphone) or LOW (line out), according to type of recorder output jack used.

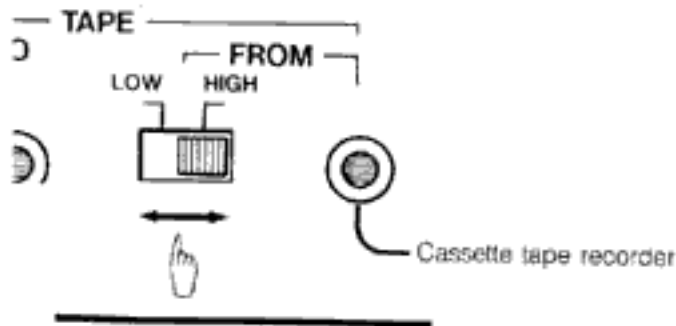

TAPE RECORDER OUTPUT JACK	HIGH/LDW
Line out (AUX)	LOW
Earphone out Headphones out	HIGH

- Rewind the tape to a little before the recording starts, and play it back.

- Stop the tape (or press Pause) when you hear the beginning of the leader tone.

- Set the recorder Volume control to a medium level (around 5). If tone controls are provided (Treble and/or Bass), set them flat.

- Set rear panel TAPE ENABLE/DISABLE switch to the ENABLE position. The DISPLAY will show the following message:

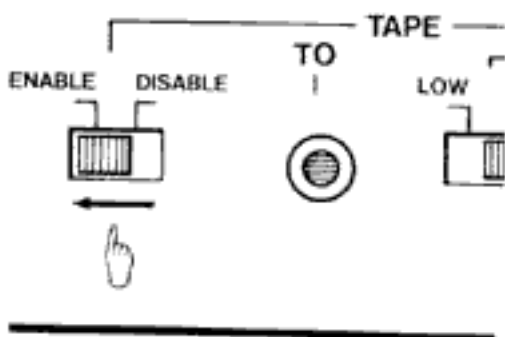

- Press the VERIFY button. The DISPLAY will show the following:

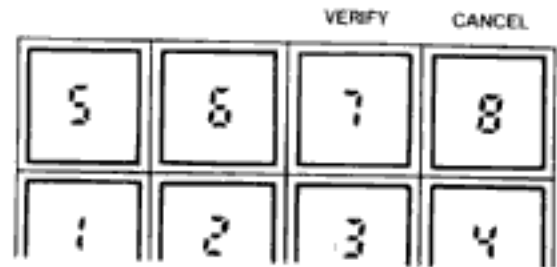

- Start tape recorder playback. It will take about 14 seconds to Verify the data. There are three possibilities:

- The recorded data is GOOD (go to step 7).
- There is an ERROR, and either the recorded data is bad or there is a level setting problem (go to step 8).
- There is no apparent change (go to step 9).

- If the VERIFY operation was successful, the DISPLAY will show this message:



- Stop the tape recorder, and return the rear panel TAPE ENABLE switch to the DISABLE position.

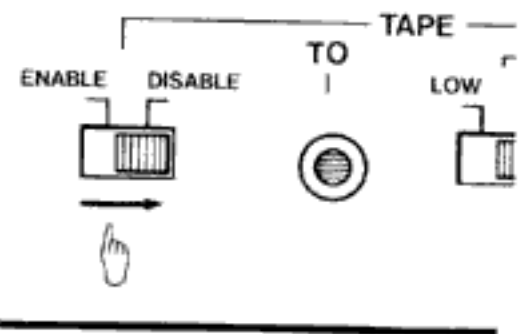

- If you got an Err (Error) indication, press the CANCEL button. You will obtain the normal TAPE message on the DISPLAY.



- Repeat the VERIFY procedure using different tape recorder Volume settings (1/2 to 1 number at a time).



You may also try changing the setting of the FROM TAPE "HIGH/LOW" switch.

- When you find settings that work, write them down for future reference.
9. If the "Verify" message is still displayed 15 seconds after starting playback, either the recorder level is too low or there is a problem with the cables.
- Press the CANCEL button, set the recorder Volume somewhat higher, and repeat the VERIFY procedure from step 2.

IMPORTANT NOTES

- YOU WILL NOT GET A "GOOD" MESSAGE IF THE TAPE DATA IS DIFFERENT IN ANY WAY FROM THE DATA IN THE EX-800, even if VERIFY has been performed properly and all settings are fine. This is because the VERIFY procedure checks to make sure that the Program and Sequencer data on the tape MATCHES the data in the EX-800 memory.
- THINGS TO TRY if you repeat the VERIFY procedure several times and still do not get a "Good" indication:
 - repeat the SAVE procedure using different recording levels. When you find a level that works, WRITE IT DOWN FOR FUTURE REFERENCE.
 - try a different, higher quality brand of tape.
 - make sure that the heads of your tape recorder are clean and demagnetized.
 - try a different tape recorder
 - check your batteries and AC adaptor. The Tape Interface may not work reliably with low batteries, with other than the recommended KORG AC adaptor, or at low line voltages.

7.4 LOADING DATA INTO THE EX-800

Both Program and Sequencer data is always recorded on the tape. However, you can choose the data you want to LOAD back into the EX-800:

- Program Data only
- Sequencer Data only
- Both Program and Sequencer Data

NOTE:
LOADING data from tape ERASES the corresponding data previously in the EX-800.

1. Connect EX-800 rear panel FROM TAPE jack to the tape recorder output jack (EARPHONE or LINE OUT). Set FROM TAPE switch to HIGH (earphone) or LOW (line out), according to type of recorder output jack used.

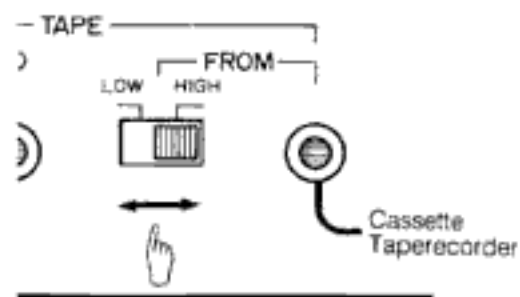

TAPE RECORDER OUTPUT JACK	HIGH/LOW
Line out (AUX)	LOW
Earphone	HIGH
Headphones	HIGH

2. Rewind the tape to a little before the recording starts, and play it back.
 - Stop the tape (or press Pause) when you hear the beginning of the leader tone.
3. Select proper settings for the tape recorder Volume and Tone controls and the rear panel FROM TAPE HIGH/LOW switch. (Use settings that produced a "Good" indication during VERIFY.)
4. Set rear panel TAPE ENABLE/DISABLE switch to the ENABLE position.

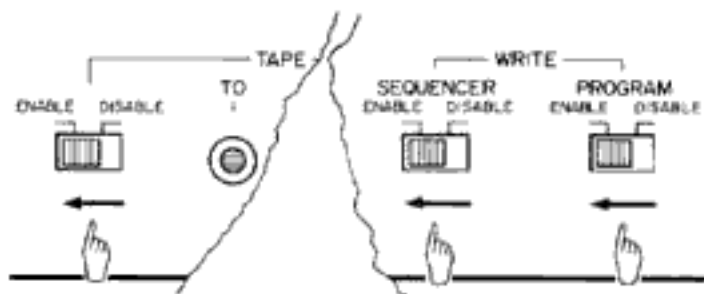

5. Select whether Program data, Sequencer data or both will be loaded.
 - To LOAD Program data, set the rear panel PROGRAM WRITE switch to the ENABLE position.
 - To LOAD Sequencer data, set the rear panel SEQUENCER WRITE switch to the ENABLE position.
 - If you don't want to LOAD Program data (or Sequencer data), make sure that the appropriate WRITE switch is in the DISABLE position.

6. Press the LOAD button:

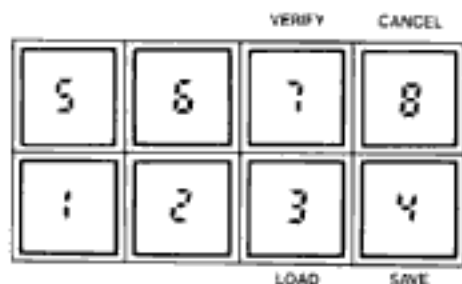

What you see on the display



7. Start tape recorder playback. It takes about 14 seconds to LOAD data.

8. If the LOAD operation was successful, the DISPLAY will show this message:



- Stop the tape recorder, and return rear panel TAPE and WRITE switches to the DISABLE position.

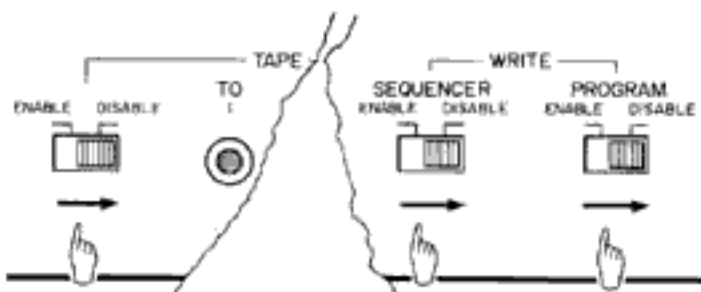

9. If you get a "Err" (Error) message, or if the DISPLAY doesn't change at all after about 15 seconds, press the CANCEL button and repeat the LOAD procedure from step 2, using different volume settings.



- Steps 8 and 9 of the VERIFY procedure offer further suggestions that work just as well for LOADING data into the EX-800.

- You MUST use "LOAD" rather than "VERIFY" if the Sequencer and Program data on the tape is different from that in the EX-800. When tape data is different, you'll never get a "Good" message during VERIFY.

- If this occurs, and you don't want to lose the current EX-800 data, SAVE it on a different tape and VERIFY it first, and then LOAD in the other tape data. This should also help find the correct level settings for LOADING. (If SAVE and VERIFY don't work for some reason, then LOAD won't either.)



NOTE:

After you have finished using the Tape Interface, set the rear panel TAPE switch to the DISABLE position (and make sure all WRITE switches are also set to DISABLE).

You will not be able to play the EX-800 if the TAPE switch is left in the ENABLE position.

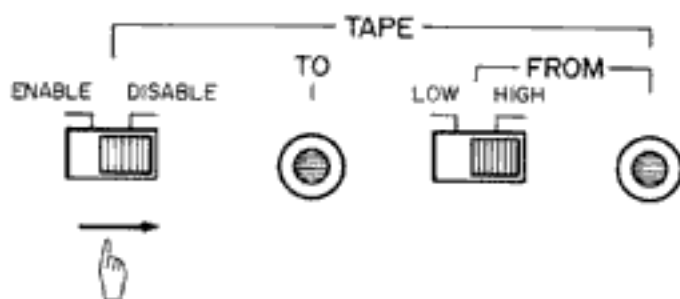

8. POWER SUPPLY

AC Adaptor Precautions

Only use the supplied AC adaptor to power the EX-800. The use of other power sources may damage the EX-800.

Use the adaptor in an AC outlet of its specified voltage. Malfunctioning or damage may occur if it is plugged into a socket having too high or low a voltage.

9. RACK MOUNTING

See diagram for mounting in EIA 19" rack.

parts needed: Rack mount adaptor (supplied) × 2
Screws × 4

1. Attach rack mount adaptors to EX-800.

Remove screws from the EX-800 and use them to attach the rackmount adaptor.

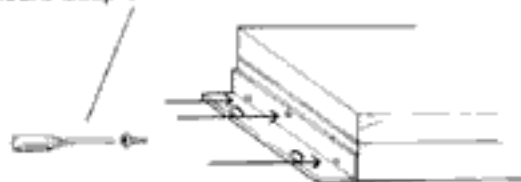

2. Mount in rack.

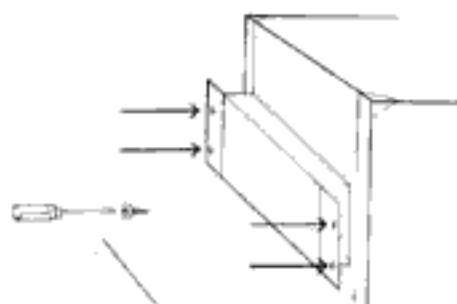

Use supplied screws to mount on rack.

Important:

1. Leave space (one or two units) above EX-800 to permit access to rear panel connections and switches.
2. When mounting with other units, mount in order of size and weight, putting longer, heavier units at bottom.
3. Once a month check for loosening of screws.

SPECIFICATIONS/OPTIONS

- Voice 8 Voice (WHOLE mode)
4 Voice (DOUBLE mode)
- DCO 1 Octave (LOW, MID, HIGH), Waveform (\sphericalangle , \sqcap), 16' 8' 4' 2' (ON/OFF) Level (0 - 31)
- DCO 2 Octave (LOW, MID, HIGH), Waveform (\sphericalangle , \sqcap), 16' 8' 4' 2' (ON/OFF) Level adjustment, Interval (0 - 12 semitones), Detune (-20 cent MAX)
- DCO Mode (WHOLE, DOUBLE)
- Noise Level (0 - 15) (White noise)
- VCF Cutoff Frequency (0 - 99), Resonance (0 - 15), Keyboard Track (OFF, HALF, FULL), EG Intensity (0 - 15) EG Polarity (\sphericalangle , \sphericalcap), Trigger mode (for DEG 3 only) (SINGLE, MULTI)
- Chorus ON/OFF
- DEG 1 (FOR DCO 1) Attack time, Decay time, Break Point level, Slope time, Sustain level, Release time (ALL 0 - 31).
- DEG 2 (FOR DCO 2) Attack time, Decay time, Break Point level, Slope time, Sustain level, Release time (ALL 0 - 31).
- DEG 3 (FOR VCF & NOISE) Attack time, Decay time, Break Point level, Slope time, Sustain level, Release time (ALL 0 - 31).
- MG Frequency, Delay time, DCO intensity, VCF intensity (ALL 0 - 15).
- MIDI Receive Channel (1 - 16), Program Change (ENABLE/DISABLE), Sequencer Clock (INT, EXT), Bend (INTENSITY)
- TUNE +/- 50 cents
- Key data receivable range C1 - C6/61 keys (36 - 96 AT MIDI)
- Power OFF, Master VOLUME
- Sequencer START/STOP, STEP, SPEED (Slow - Fast)
- Programs 64 (11 to 88)
- Programmer Number select buttons (1-8), PROGRAM/PARAMETER, BANK HOLD, UP, DOWN, WRITE switches
- Display Program Number, Parameter Number, Parameter Value, Bank hold indicator, Edit indicator
- Tape interface Save, Load, Verify, Cancel
- Input jacks FROM TAPE (HIGH/LOW), PROGRAM UP (\sphericalcap GND)
- Output jacks Output (R, L/MONO), HEADPHONES, TO TAPE.
- Tape switch ENABLE/DISABLE
- Write switch Program (ENABLE/DISABLE) Sequencer (ENABLE/DISABLE)
- MIDI jack IN, OUT, THRU
- DC 9V AC adapter jack (300 mA minimum; use only recommended KORG adapter)
- Dimensions W: 404 mm x D: 222.5 mm x H: 64.5 mm
- Weight 2.6 kg
- Accessories AC adapter, Cassette tape of Factory Preload Programs, Rack mount adaptor (x2), Screws (x4), 5-pin DIN cord
- Options Soft Case, KH-1/Headphones, MIDI Connection Cord, PS-1/Pedal Switch

MIDI IMPLEMENTATION

1 Transmission data

Transmittable data consist of system exclusive messages only. These are used for the computer dump function.

System Exclusive Messages

	STATUS	DATA	DESCRIPTION
RAM DATA	11110000	01000010	KORG ID
		00100001	FORMAT ID
		00000001	EX-800 ID
		(0000****)	LSB RAM DATA 1-word
		0000****)	MSB
DATA ERROR MESSAGE	11110000	01000010	KORG ID
		00100001	FORMAT ID
		00000001	EX-800 ID
		00100000	DATA ERROR MESSAGE
		11110111	EOX

NOTE:

1. Data error message is sent if there is a check sum error during memory load. Error message: (F0_H, 42_H, 21_H, 01_H, 20_H, F7_H)
2. The request sent by the computer must be: F0_H, 42_H, 21_H, 01_H, 10_H, F7_H (where "H" means hexadecimal). Memory data is then output in the order: F0_H, 42_H, 21_H, 01_H, memory data check sum, F7_H —

2 Reception data

Channel Messages

STATUS	2nd byte	3rd byte	DESCRIPTION
1000nnnn	0kkkkkkk	0-.....	NOTE OFF EVENT
1001nnnn	0kkkkkkk	0vvvvvvv	NOTE ON EVENT (vvvvvv ≥ 1) vvvvvv = 0: OFF
1011nnnn	00000001	0vvvv---	DCO MODULATION
1011nnnn	00000010	0vvvv---	VCF MODULATION
1011nnnn	00000111	0vvvvvvv	VOLUME CONTROL
1011nnnn	0ccccccc	00000000	MODE CHANGE OMNI OFF (ccccccc = 7C _H) OMNI ON (ccccccc = 7D _H)
1100nnnn	0ppppppp		PROGRAM CHANGE
1110nnnn	0-.....	0bbbbbbb	PITCH BEND

NOTE:

1. CHANNEL NUMBER:
nnnn = 0_H - F_H (ch1 - ch16)
2. NOTE NUMBER:
kkkkkkk = 36 - 96
If received data is outside of this range, it will be transposed to nearest note of the same name.
3. Negative numbers are ignored.
4. OMNI ON/OFF is always interpreted as being accompanied by POLY-ON.
Separate POLY-ON or MONO-ON messages are ignored.
5. ppppppp = 0 - 127 (PROGRAM NUMBER)
However, if number exceeds 63 then subtract 64 to find value as interpreted.
Example:
74 = 10
64 = 0
6. VOLUME CONTROL:
vvvvvvv = 7F_H is the loudest volume. Volume decreases as value approaches 00_H.

System Real Time Messages

STATUS	DESCRIPTION
11111000	SEQUENCER CLOCK
11111010	SEQUENCER START
11111100	SEQUENCER STOP
11111110	ACTIVE SENSING

CAUTION:

ACTIVE SENSING

If FE_H (STATUS 11111110) is ever received, then another FE_H or other MIDI data must be received every 300ms, otherwise the voices will be turned off. If FE_H is never received then operation will continue as usual.

System Exclusive Messages

	STATUS	DATA	DESCRIPTION
DUMP DATA	11110000	01000010	KORG ID
		00100001	FORMAT ID
		00000001	EX-800 ID
		(0000 * * * *)	LSB } RAM DATA 1-word
		0000 * * * *)	MSB }
DATA DUMP REQUEST	11110000	01000010	KORG ID
		00100001	FORMAT ID
		00000001	EX-800 ID
		00100000	DATA REQUEST
		11110111	EOX





NOTE:

- EX-800 begins RAM data dump about 300msec after it receives the final F7_H in the RAM data request above.
- $\sum_{n=1}^{1023}$ (One word of RAM data) Least significant 8 bits are used for check sum.
- Send data to EX-800 MIDI IN in the order: F0_H, 42_H, 21_H, 01_H, memory data check sum, F7_H, Internal.

RAM Data Chart

DATA	RELATIVE ADDRESS	BYTES
MIDI CH	0000 _H	1
SEQUENCER DATA	0001 _H	256
UNDEFINED	0101 _H	9
BEND DEPTH	010A _H	1
UNDEFINED	010B _H	21
PROGRAM DATA	0120 _H	1345

※ SEQ DATA is as shown below.

SYMBOL	DATA	NOTE
	00 _H	Fine
	01 _H	Rest
	02 _H	Tie
	1k k k k k k k k k k	MSB=0: Notes remain for that timing.
	0k k k k k k k k k k 0k k k k k k k k k k 1k k k k k k k k k k	

EXAMPLE:



DATA: B4_H, 02_H, B5_H, 02_H, 01_H, 01_H, B7_H, B9_H, 34_H, 37_H, BC_H, 02_H, 02_H, 02_H, 02_H, 02_H, 01_H, 01_H, 00_H

※ Important: EX-800 does not use undefined data except for check sum.

Panel Control

PARAMETER NO.	PARAMETER	VALUE
85	RCV CH	1-16
86	PROG CHANGE	0-1
87	BEND	0-64
88	SEQ CLK	1-2

Program Parameter per ONE note

Byte	bit	7	6	5	4	3	2	1	0
1		← DCO 2 WAVEFORM →		← DCO 1 WAVEFORM →		← DCO 2 OCTAVE →		← DCO 1 OCTAVE →	
2		← DCO 2 FEET ON/OFF →				← DCO 1 FEET ON/OFF →			
3		← CHORUS ON/OFF →	← DCO 2 ON/OFF →	UNDEFINED				← DCO 2 DETUNE →	
4		← NOISE LEVEL →				← DCO 2 INTERVAL →			
5	*	← DCO 1 LEVEL →	← VCF EG POLARITY →		← VCF EG INT →				
6		UNDEFINED		← DCO 2 LEVEL →				*	
7		← VCF TRIGMODE →	← VCF CUTOFF →						
8		← MG DELAY →				← MG FREQ →			
9		← MG VCF INT →				← MG DCO INT →			
10	*	← DEG 1 DECAY →				← DEG 1 ATTACK →			
11	*	← DEG 1 BREAK.P →				← DEG 1 SLOPE →			
12	*	← DEG 1 SUSTAIN →				← DEG 1 RELEASE →			
13	*	← DEG 2 DECAY →				← DEG 2 ATTACK →			
14	*	← DEG 2 SLOPE →				← DEG 2 BREAK.P →			
15	*	← DEG 2 SUSTAIN →				← DEG 2 RELEASE →			
16	*	← DEG 3 ATTACK →				← DEG 3 DECAY →			
17	*	← DEG 3 SLOPE →				← DEG 3 BREAK.P →			
18	*	← DEG 3 RELEASE →				← DEG 3 SUSTAIN →			
19	*	← VCF KBD TRACK →		← VCF RESONANCE →				*	
20									
21									

PRAMETER WITH * EXCEEDS BYTE UNIT.
NO SPACE BETWEEN NOTES