

Rhythm Plus

PB-300 OWNER'S MANUAL

Introduction

The Rhythm Plus PB-300 is a unique playing device featuring the MIDI system. By simply connecting the PB-300 to the HP-300/400, you can enjoy Rhythm, Bass, and Chord (or Arpeggio) playing. Sixteen different kinds of Rhythm patterns are preset in the PB-300, and the Bass and Chord (or Arpeggio) Pattern matching to each rhythm can be automatically selected.

The PB-300 has various useful functions, such as the Intro and Fill In. As well, the volume of the accompaniment is controlled by the strength of the attack on the keys. By setting it up with the PR-800 (Digital Piano Recorder), a wider variety of effects is possible.

Please read this owner's manual carefully.

*MIDI

(Musical Instrument Digital Interface)

MIDI is an internationally standard interface system. Devices featuring MIDI can exchange digital signals, allowing automatic play, synchronization, and other possibilities.

Contents

Important	3
Panel Description	4
Connections	4
① Auto Rhythm	6
1. Fill In, Break	
2. Intro	
3. Accent	
② Auto Play	8
1. Lower and Upper Sections	
2. Auto Play	
3. Tuning	
③ Other Functions	11
④ Using the PB-300 and PR-800 together	12
⑤ Preset Patterns	14
Specifications	19
Options	19

Important Notes

Location

- Operating the PB-300 near a neon or fluorescent lamp may cause noise interference. If so, change the angle of the PB-300.
- Avoid using the PB-300 in excessive heat or humidity, or where it may be affected by direct sunlight or dust.

Power Supply

- The appropriate power supply for this instrument is shown on its name plate. Please be sure that the voltage system in your country meets this.
- This instrument might generate heat while operating, but there is no need to worry about it.

Cleaning

- Use a soft cloth and neutral detergent for cleaning.
- Do not use solvents such as paint thinner.

Panel Description

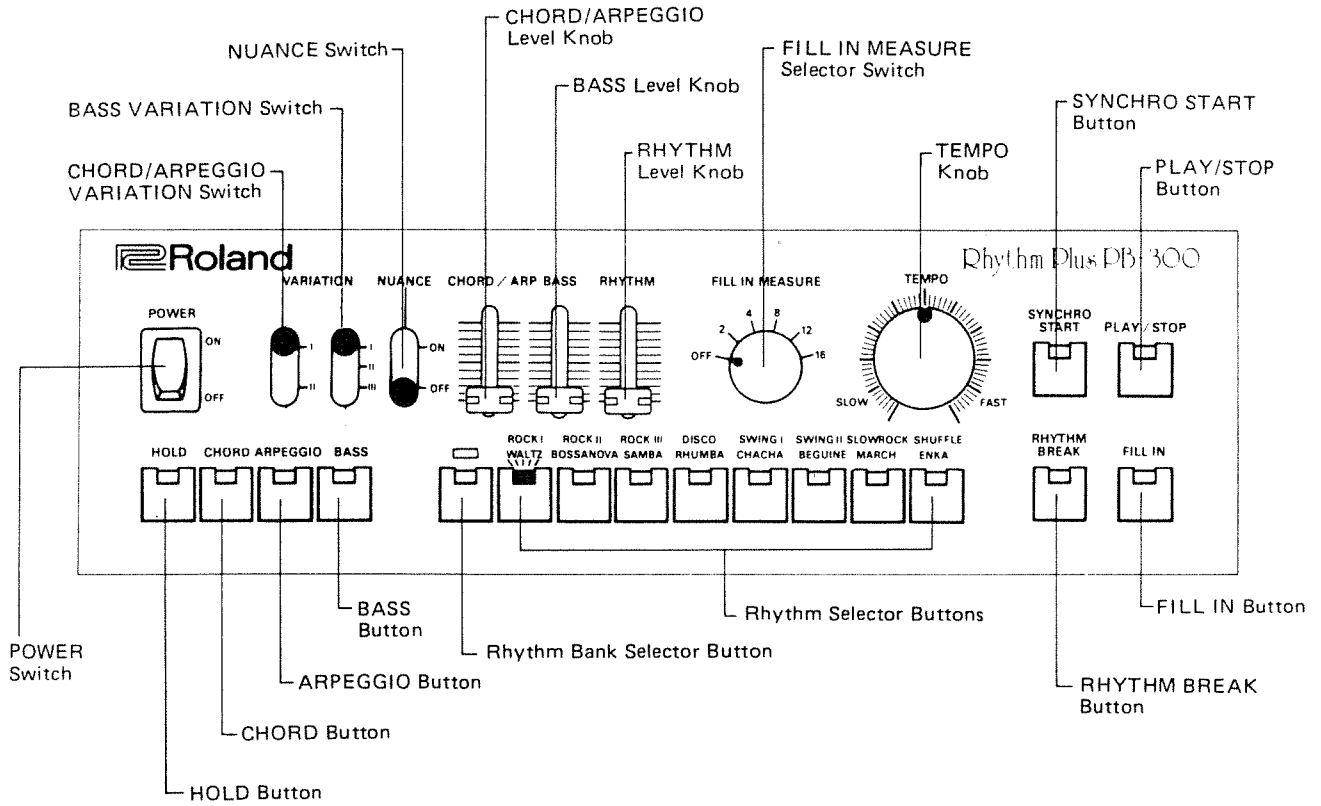

Connections

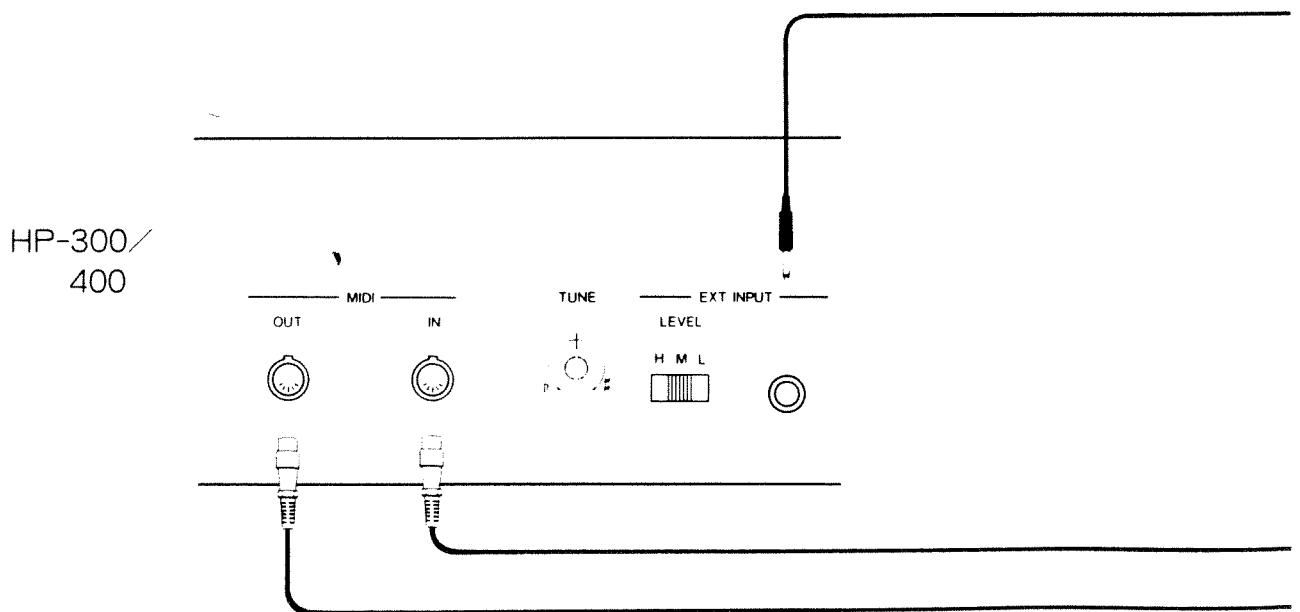

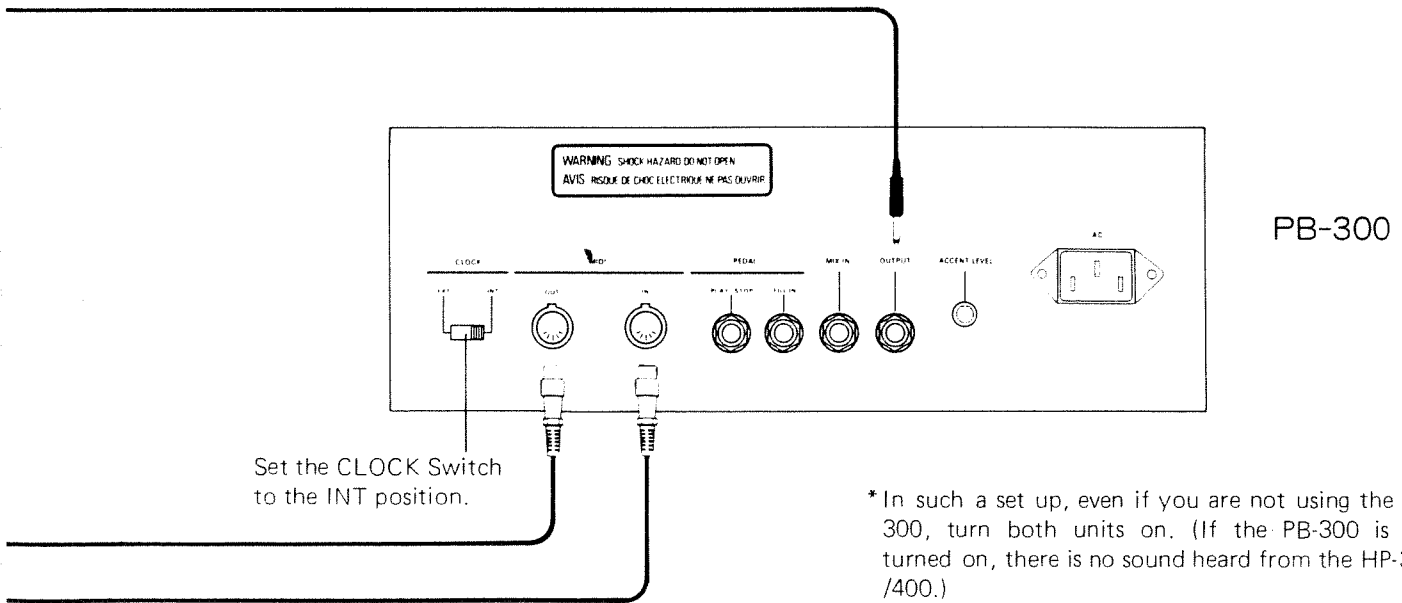
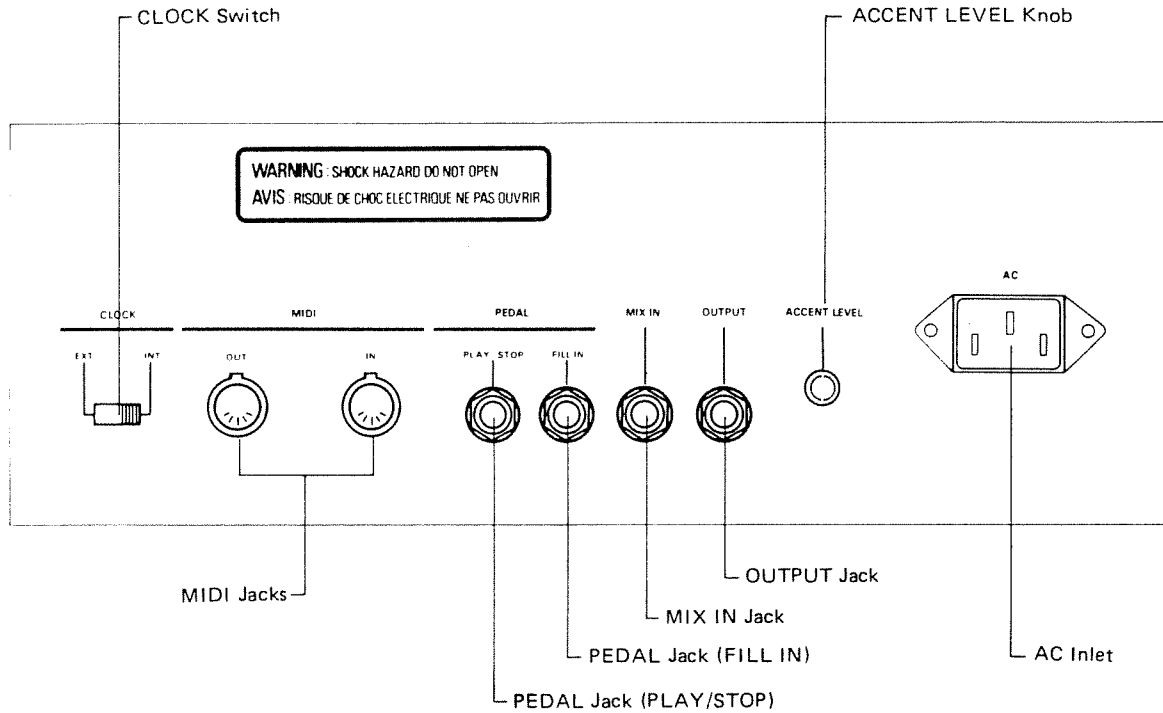

* In such a set up, even if you are not using the PB-300, turn both units on. (If the PB-300 is not turned on, there is no sound heard from the HP-300 /400.)

1 Auto Rhythm

1 Rhythm Bank Selector Button

This button is used to choose either the upper group (ROCK I to SHUFFLE) or lower group (WALTZ to ENKA) or rhythms. Each time you press this button, the upper or lower group is alternately selected. The indicator lights up when the lower group is selected.

2 Rhythm Selector Buttons

You can select any Rhythm on the selected bank just by the flick of a switch.

3 RHYTHM Level Knob

This knob controls the volume of the rhythm. Raising the slider increases the volume.

4 TEMPO Knob

This is to control the playing tempo of the Rhythm or other Auto playing. Rotating this clockwise will quicken the tempo.

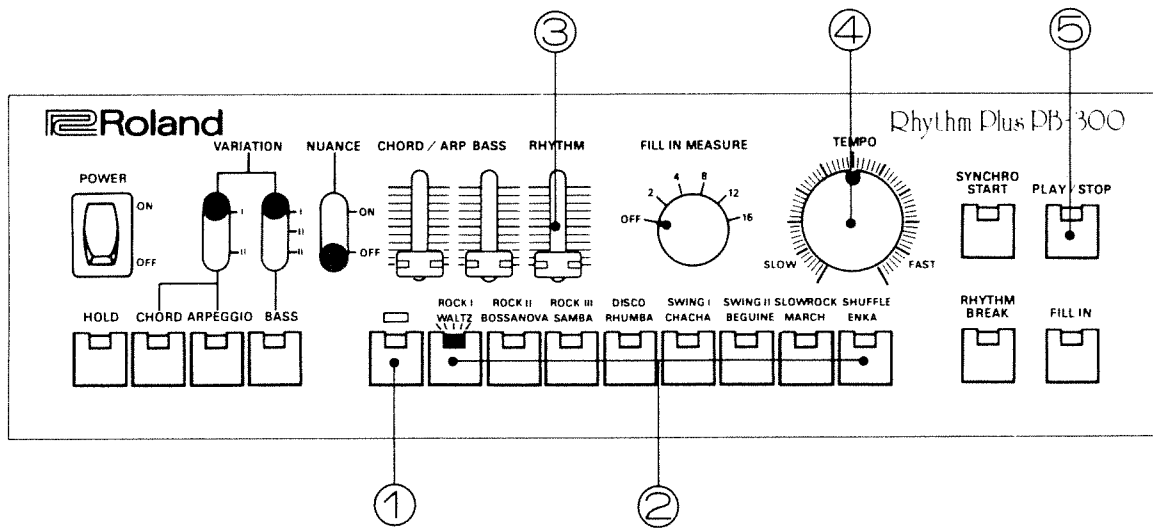

5 PLAY/STOP Button

When this button is pressed, the Rhythm starts. When pressed again, it stops. While the Rhythm is playing, the indicator flashes at the same tempo as the Rhythm.

* It is possible to start or stop the Rhythm playing with the Foot Pedal by connecting the Soft Pedal of the HP-300/400 (or the optional DP-2). When you use the Soft Pedal, connect it as shown in the figure beside.

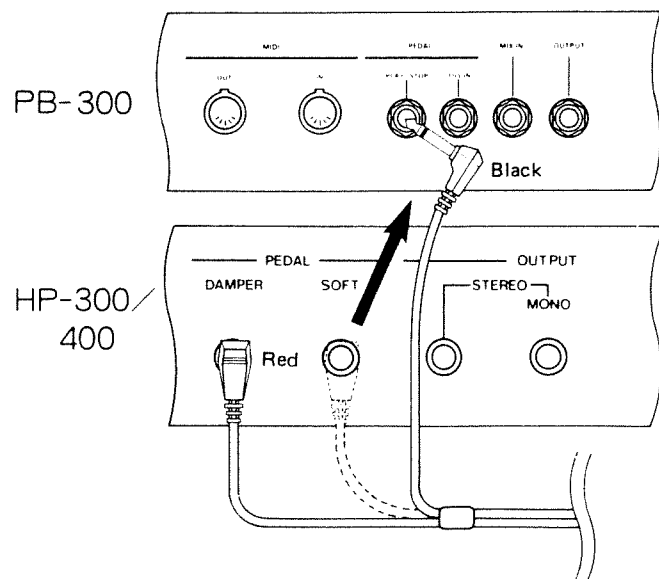

1. Fill In, Break

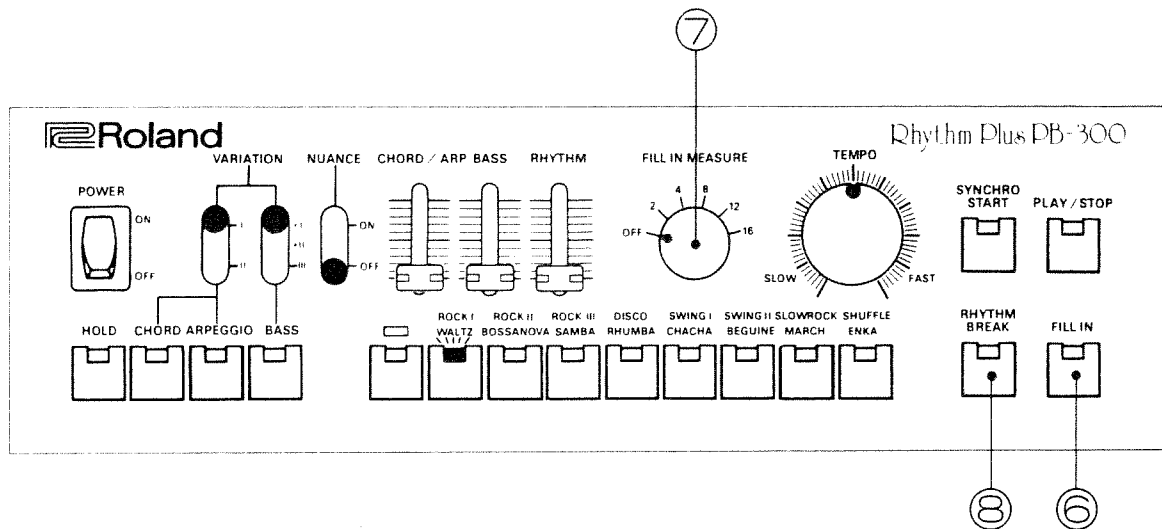

6 FILL IN Button

If you press this button during Rhythm playing, the indicator lights up and Fill In Rhythm will be inserted in the next measure.

*The Fill In Rhythm is pre-programmed in each Rhythm.

7 FILL IN MEASURE Selector Switch

If you want the Fill In Rhythm to be regularly inserted automatically, use this switch. For example, if you want the Fill In Rhythm in every other measure, set the switch to "2".

* It is possible to use the Soft Pedal of the HP-300/400 for inserting Fill In Rhythm. (If the Soft Pedal is already used for other purpose, you may use the optional DP-2).

8 RHYTHM BREAK Button

If you press this button during Rhythm playing, the indicator lights up and the Rhythm sound will be completely muted. If you press it again, the indicator goes out and the Rhythm sound will return.

2. Accent

Using the ACCENT LEVEL Knob on the rear panel, you can control the intensity of the Accent. Rotating this clockwise will emphasize the accent.

ACCENT LEVEL



3. Intro

If you press the FILL IN Button before starting the Rhythm, one measure Intro Fill In Rhythm will be played (before the normal base rhythm).

2 Auto Play

You can vary the Automatic Bass and Chord (or Arpeggio) playing to match the Auto Rhythm in use.

The following are ways to play the Auto Bass and Chord (or Arpeggio).

- 1 Press the BASS Button and the CHORD Button.
* The indicator lights up.

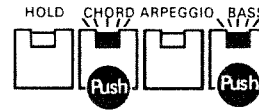

- 2 Set the CHORD/ARPEGGIO Level Knob and BASS Level Knob to the proper positions.

CHORD / ARP BASS

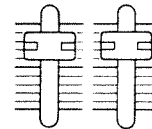

- 3 Press the PLAY/STOP Button.
* The Rhythm will start playing.



- 4 Play a chord (up to four notes) on the Lower Section of the keyboard (shown in the figure on P. 9).

* Depending on the chord you have played, Auto Bass and Chord will play along with the Rhythm.

* If you press the ARPEGGIO Button instead of the CHORD Button, Auto Arpeggio will be played.

* The Auto Chord (or Arpeggio) is played two octaves higher than the keys you are actually pressing. The chord actually being pressed does not sound at all.

* By changing the CHORD/ARPEGGIO VARIATION and the BASS VARIATION switch positions, you can enjoy a wide variety of playing patterns. (Refer to " 5 Preset Patterns" on P. 14.)

* If the HOLD Button is depressed, automatic playing will continue even after the keys are released. If you play a new chord, that chord will be held.

* If the Bass and Chord pitches are different, adjust them according to the "3. Tuning" on P. 11.

* The Bass is played with the PB-300's sound source and Chord (or Arpeggio) uses the HP-300/400's sound source. In other words, the accompaniment, except for the Rhythm and Bass sounds, is played with the tone colors of the HP-300/400.

1. Lower and Upper Sections

When the Auto Bass and Chord (or Arpeggio) is being played, the keyboard of the HP-300/400 is split into the Lower and Upper Sections as shown in the figure.

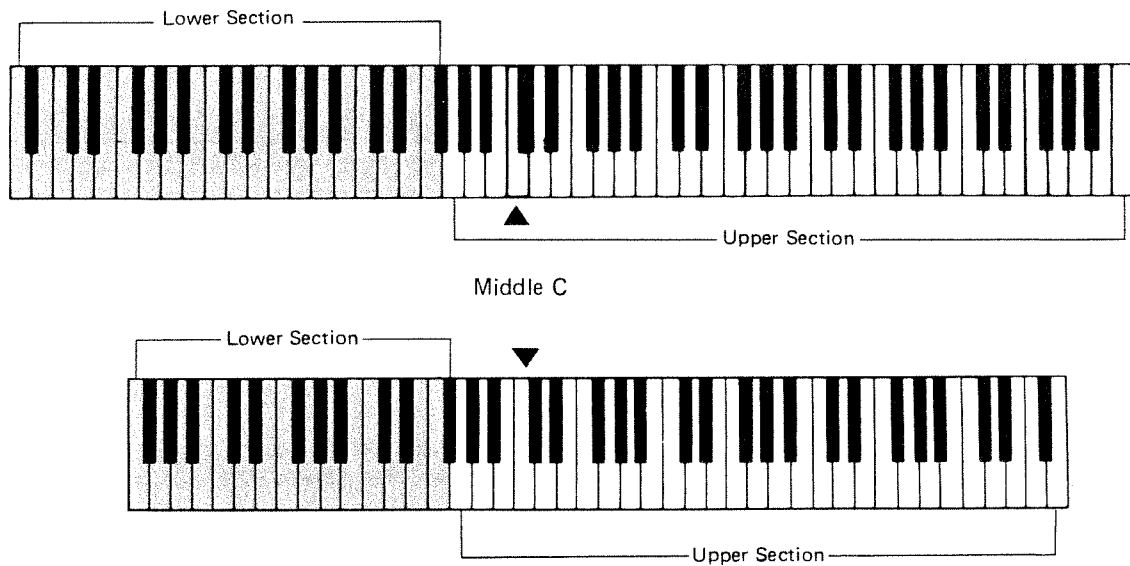

* The split point is between F₃[#] and G₃.

Lower Section

Auto Bass and Chord will change depending on the chord you play on the Lower Section of the keyboard.

Upper Section

You can play the Upper Section of the keyboard even during auto play.

2. Auto Play (Revise)

- ⑨ **CHORD/ARPEGGIO VARIATION Switch**
 This switch selects two modes of Chord (or Arpeggio) patterns.
 * The pattern varies depending on the Rhythm.
- ⑩ **BASS VARIATION Switch**
 This switch selects two modes of Auto Bass Patterns.
 * The pattern varies depending on the Rhythm.

- ⑪ **CHORD/ARPEGGIO Level Slider**
 This slider controls the volume of the Auto Chord or Arpeggio. Raising the slider increases the volume.
- ⑫ **BASS Level Slider**
 This slider controls the volume of the Auto Bass. Raising the slider increases the volume.

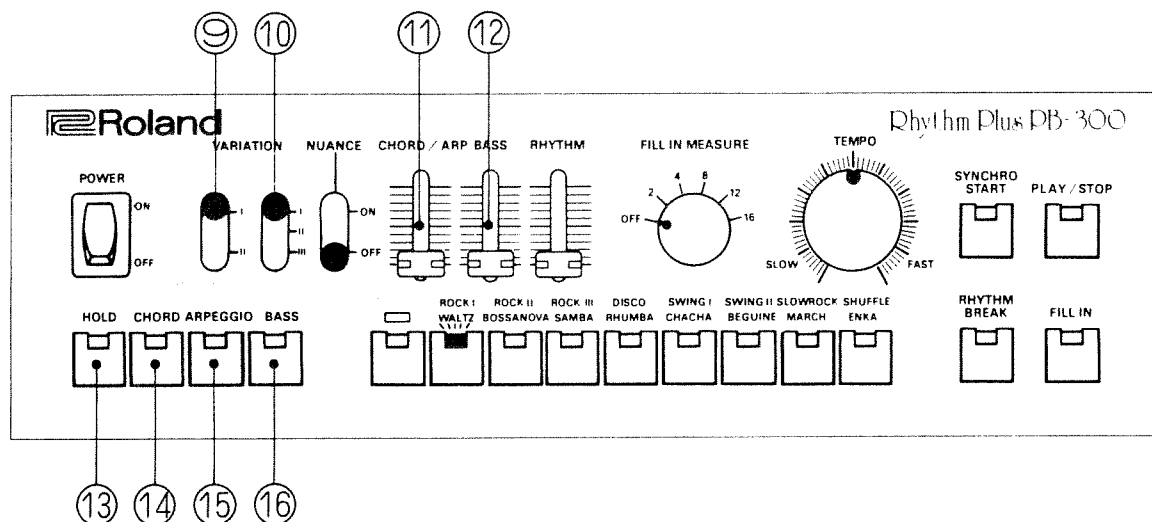

- ⑬ **HOLD Button**
 Hold effect (continuous play) can be obtained by pressing this button.
- ⑭ **CHORD Button**
 When this button is pressed, the indicator lights up and Auto Chord plays. Pressing the same button again (or the ARPEGGIO Button) will stop the Auto Chord play.
- ⑮ **ARPEGGIO Button**
 When this button is pressed, the indicator lights and the Auto Arpeggio play. Pressing the same button again (or the CHORD Button) will stop the Auto Arpeggio play.
- ⑯ **BASS Button**
 When this button is pressed, the indicator lights up and Auto Bass plays. Pressing the same button again will stop playing.

3. Tuning

If the Bass and Chord pitches are different, you need to tune them.

- 1 Set the Front panel as shown.

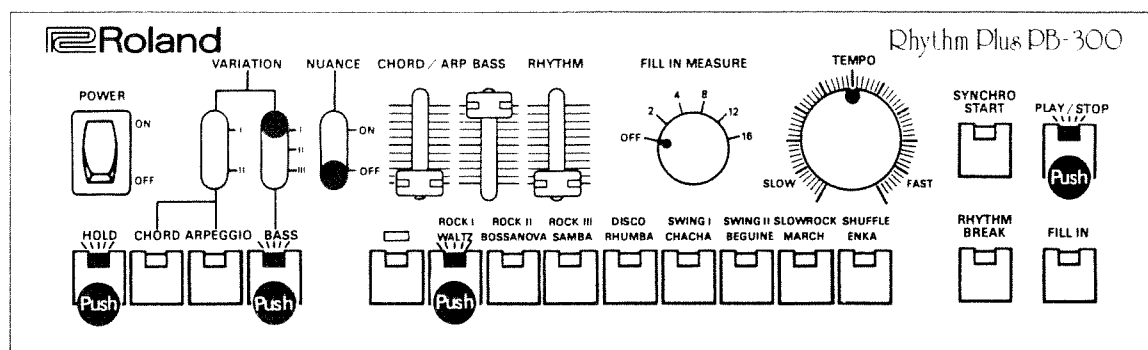

- 2 Press a key on the lower keyboard and tune the Bass and the piano pitches by using the TUNE Knob on the rear panel of the HP-300/400.

3 Other Functions

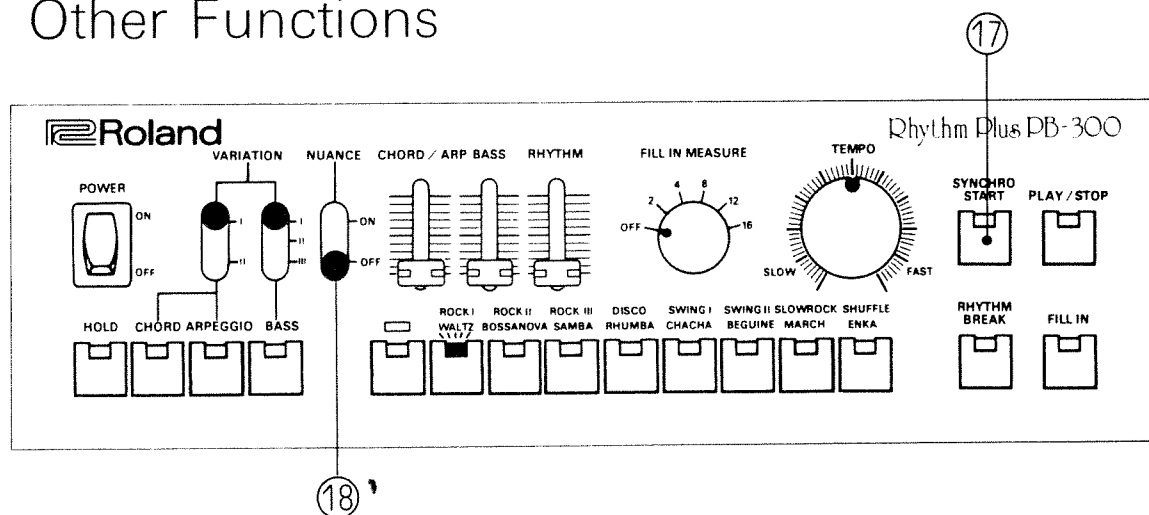

17 SYNCHRO START Button

The Synchro Start starts the Auto Rhythm and Bass and Chord (or Arpeggio) playing as soon as playing starts on the lower keyboard. Press this button when the Rhythm is stopped, and the indicator flashes at the set tempo showing that the PB-300 is now ready for synchro start. Now the moment you touch the lower keyboard, Auto Rhythm, Bass and Chord (or Arpeggio) playing will start automatically.

18 NUANCE Switch

If you turn this switch on during Bass, and/or Chord (or Arpeggio) auto play, the sound level is controlled freely depending on how hard you attack the keys.

4 Using the PB-300 and PR-800 together

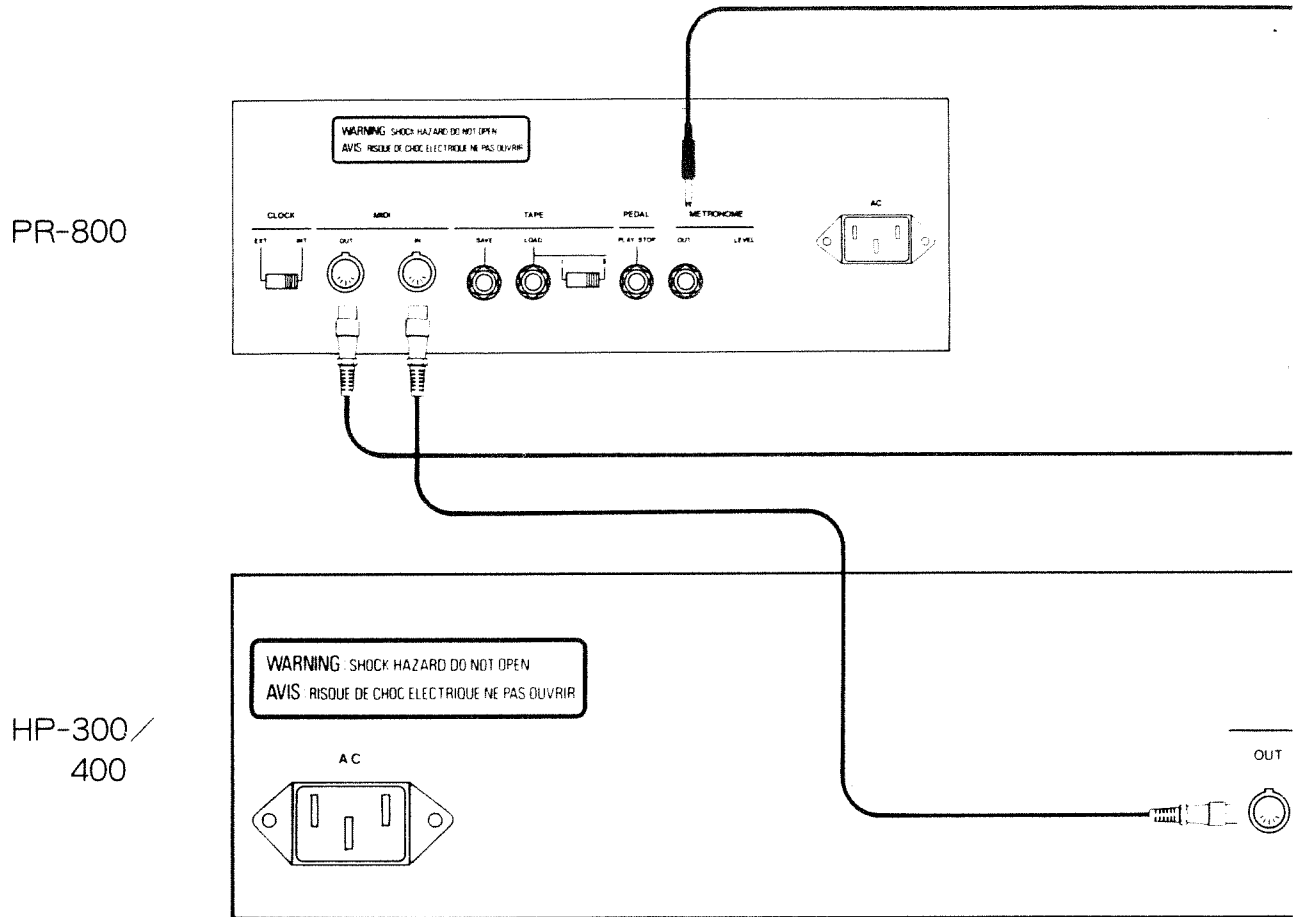

* There is no sound from the HP-300/400 unless you turn both the PB-300 and the PR-800 on.

Set the CLOCK Switch on the PB-300 to EXT.

Set the CLOCK Switch on the PR-800 to INT.

Tempo: To control the playing tempo, use the TEMPO knob of the PR-800.

PLAY/STOP: To start or stop playing, use the PLAY/STOP Buttons on the PR-800.

* The TEMPO Knob, PLAY/STOP Button and SYNCHRO START Button on the PB-300 do not function.

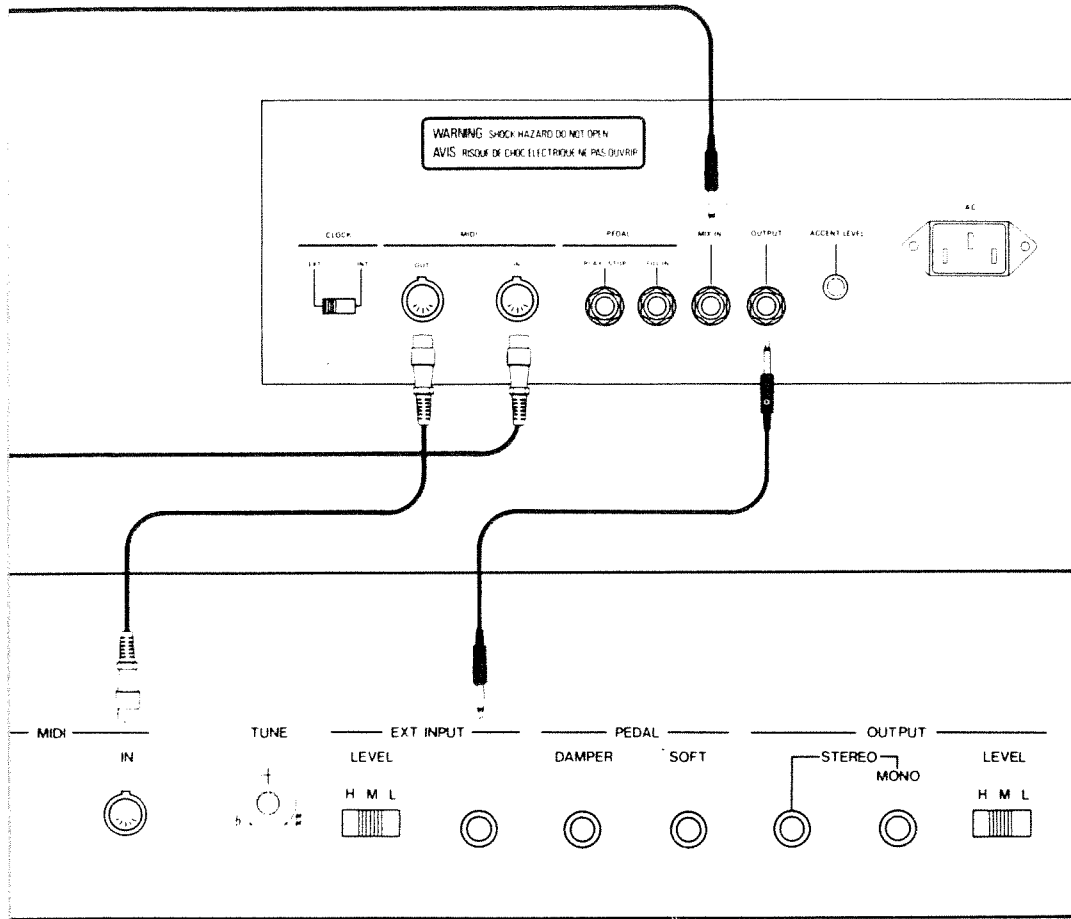

PB-300

MIX IN Jack

External sound sources can be input through this jack. The input signal is mixed with the Rhythm and Bass sounds of the PB-300 and then sent to the OUTPUT.

In this example, the Metronome sound of the PR-800 is input.

Using only the PB-300 or PR-800

For instance, if you use only the HP-300/400 and the PR-800, set the CLOCK Switch on the PB-300 to the INT position.

*The PB-300 and PR-800 are connected, but can be played separately.

*If you use only the HP-300/400 and PB-300, set the PB-300's CLOCK Switch to INT.

5 Preset Patterns

Rhythm Patterns

ROCK I

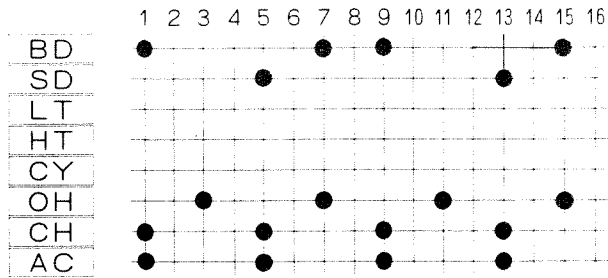

SWING I

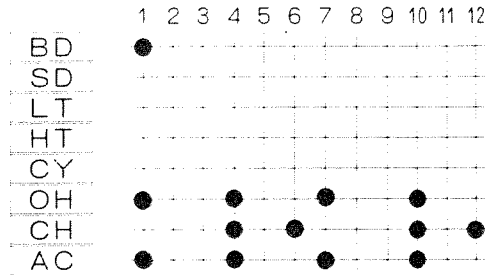

ROCK II

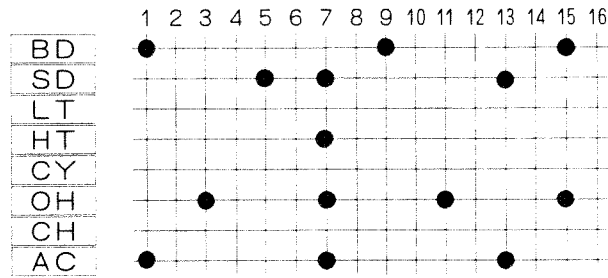

SWING II

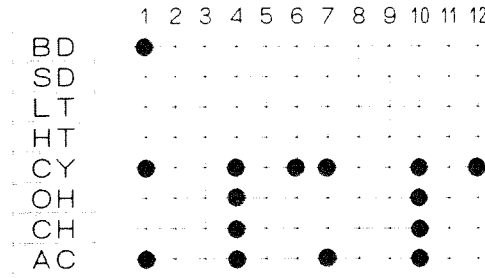

ROCK III

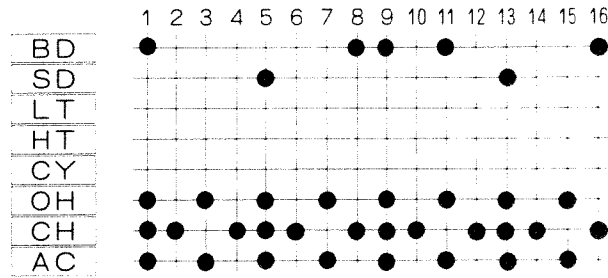

SLOW ROCK

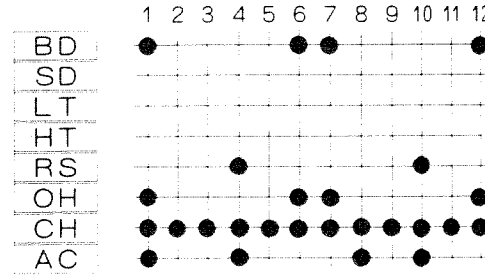

DISCO

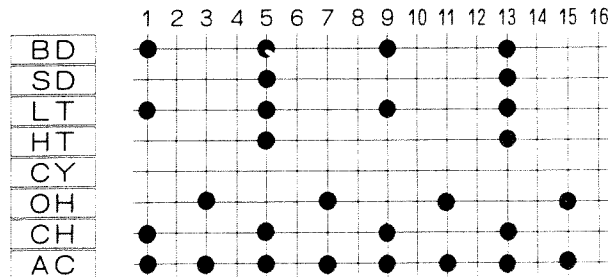

SHUFFLE

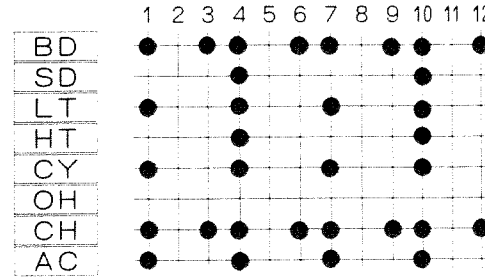

WALTZ

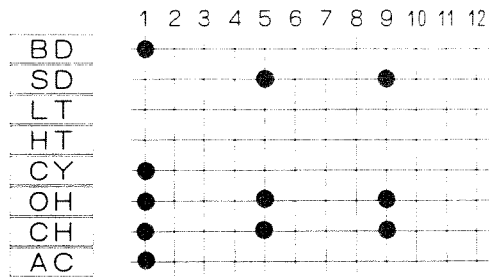

CHACHA

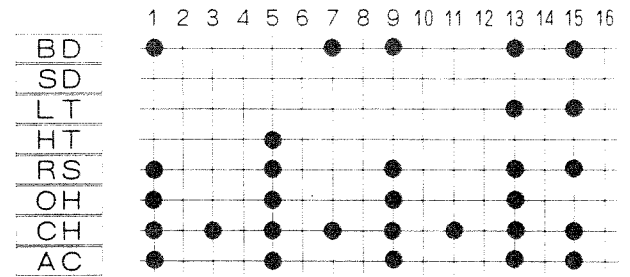

BOSSANOVA

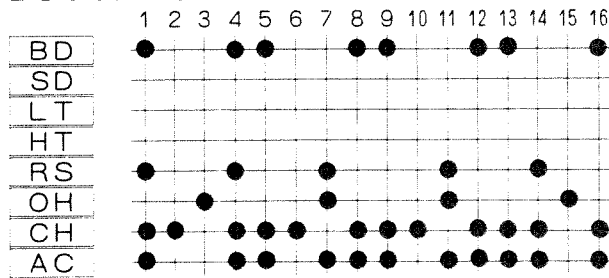

BEGUINE

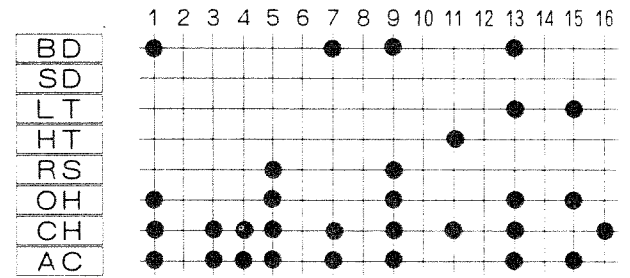

SAMBA

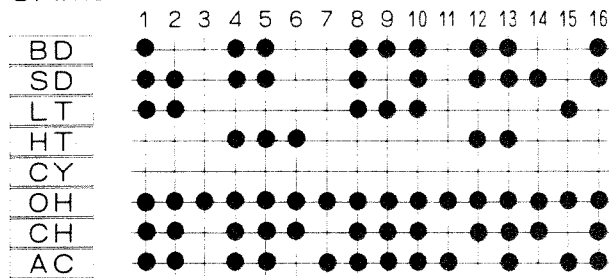

MARCH

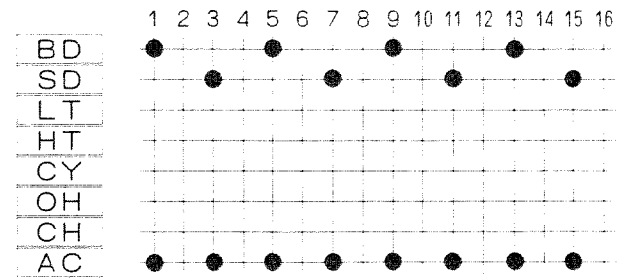

RHUMBA

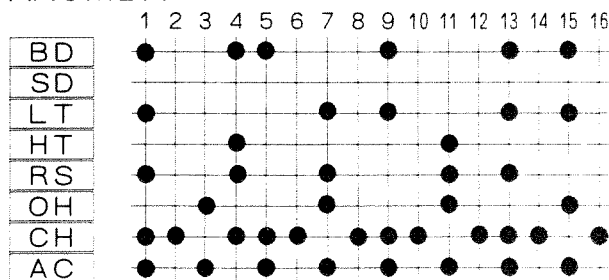

ENKA

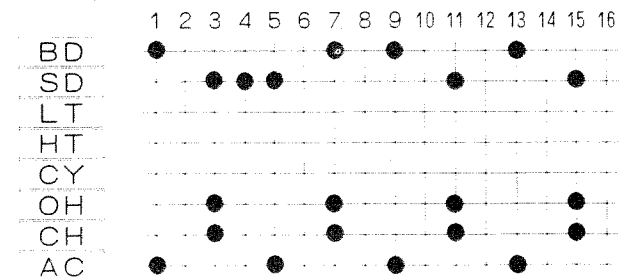

Arpeggio/Chord/Bass Pattern

ROCK I

Variation I Variation II Variation III

Arpeggio

Chord

Bass

ROCK II

Arpeggio

Chord

Bass

ROCK III

Arpeggio

Chord

Bass

DISCO

Arpeggio

Chord

Bass

SWING I

Arpeggio

Chord

Bass

*Bass and Arpeggio Pattern examples are when the C cord is played.

SWING II

Arpeggio

Chord

Bass

Musical notation for SWING II. The Arpeggio part is in the treble clef, showing a sequence of eighth notes. The Chord part is in the treble clef, showing a sequence of quarter notes. The Bass part is in the bass clef, showing a sequence of quarter notes.

SLOW ROCK

Arpeggio

Chord

Bass

Musical notation for SLOW ROCK. The Arpeggio part is in the treble clef, showing a sequence of eighth notes. The Chord part is in the treble clef, showing a sequence of quarter notes. The Bass part is in the bass clef, showing a sequence of quarter notes.

SHUFFLE

Arpeggio

Chord

Bass

Musical notation for SHUFFLE. The Arpeggio part is in the treble clef, showing a sequence of eighth notes. The Chord part is in the treble clef, showing a sequence of quarter notes. The Bass part is in the bass clef, showing a sequence of quarter notes.

WALTZ

Arpeggio

Chord

Bass

Musical notation for WALTZ. The Arpeggio part is in the treble clef, showing a sequence of eighth notes. The Chord part is in the treble clef, showing a sequence of quarter notes. The Bass part is in the bass clef, showing a sequence of quarter notes.

BOSSANOVA

Arpeggio

Chord

Bass

Musical notation for BOSSANOVA. The Arpeggio part is in the treble clef, showing a sequence of eighth notes. The Chord part is in the treble clef, showing a sequence of quarter notes. The Bass part is in the bass clef, showing a sequence of quarter notes.

SAMBA

Arpeggio

Chord

Bass

The Samba section consists of three staves. The top staff, labeled 'Arpeggio', shows a rhythmic pattern of eighth notes in the right hand. The middle staff, labeled 'Chord', shows a sequence of chords with rhythmic markings. The bottom staff, labeled 'Bass', shows a bass line with eighth notes and rests.

RHUMBA

Arpeggio

Chord

Bass

The Rhumba section consists of three staves. The top staff, labeled 'Arpeggio', shows a rhythmic pattern of eighth notes. The middle staff, labeled 'Chord', shows a sequence of chords with rhythmic markings. The bottom staff, labeled 'Bass', shows a bass line with quarter notes and rests.

CHACHA

Arpeggio

Chord

Bass

The Chacha section consists of three staves. The top staff, labeled 'Arpeggio', shows a rhythmic pattern of eighth notes with a key signature change to one sharp. The middle staff, labeled 'Chord', shows a sequence of chords with rhythmic markings. The bottom staff, labeled 'Bass', shows a bass line with quarter notes and rests.

BEGUINE

Arpeggio

Chord

Bass

The Beguine section consists of three staves. The top staff, labeled 'Arpeggio', shows a rhythmic pattern of eighth notes with a key signature change to one sharp. The middle staff, labeled 'Chord', shows a sequence of chords with rhythmic markings. The bottom staff, labeled 'Bass', shows a bass line with quarter notes and rests.

MARCH

Arpeggio

Chord

Bass

The March section consists of three staves. The top staff, labeled 'Arpeggio', shows a rhythmic pattern of eighth notes with a key signature change to one sharp. The middle staff, labeled 'Chord', shows a sequence of chords with rhythmic markings. The bottom staff, labeled 'Bass', shows a bass line with quarter notes and rests.

ENKA

Arpeggio

Chord

Bass

The Enka section consists of three staves. The top staff, labeled 'Arpeggio', shows a rhythmic pattern of eighth notes. The middle staff, labeled 'Chord', shows a sequence of chords with rhythmic markings. The bottom staff, labeled 'Bass', shows a bass line with quarter notes and rests.

Specifications

Rhythm Plus PB-300

● Front Panel

Buttons

PLAY/STOP
SYNCHRO START
RHYTHM BREAK
FILL IN
Rhythm Bank Selector
Rhythm Selector
ROCK I/WALTZ
ROCK II/BOSSANOVA
ROCK III/SAMBA
DISCO/RHUMBA
SWING I/CHACHA
SWING II/BEGUINE
SLOW ROCK/MARCH
SHUFFLE/ENKA
BASS
ARPEGGIO
CHORD
HOLD

Switches

FILL IN MEASURE (OFF, 2, 4, 8, 12, 16)
NUANCE (ON, OFF)
BASS VARIATION (I, II, III)
CHORD/ARPEGGIO VARIATION (I, II)

TEMPO Control

SLOW to FAST (♩ = 40 to 280)

Volume Controls

RHYTHM level
BASS level
CHORD/ARPEGGIO level

Power Switch

● Rear Panel

Switch

CLOCK (EXT, INT)

DIN Sockets

MIDI IN
MIDI OUT

Jacks

PLAY/STOP
FILL IN
MIX IN
OUTPUT

ACCENT LEVEL

AC Inlet

Power Consumption

8W

Dimensions

314(W) x 118 (H) x 172(D) mm
12-3/8(W) x 4-5/8(H) x 6-3/4(D) in

Weight

2.3 kg/5 lb. 1 oz.

Accessories

DIN Cable x 2
Connection Cable (LP-25) x 1
Power Cable x 1

*Specifications are subject to change without notice.

Option

- Pedal Switch
DP-2



 Roland®

PB-300 OWNER'S MANUAL '83 JULY B-3

10201

UPC 10201

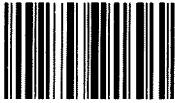

10981

Roland Corporation