



Roland *SOUND EXPANSION*

VINTAGE SYNTH M-VS1

**FREE MANUAL* do NOT PAY for IT!*



*Please do visit the M-VS1 resource center
for technical info and demo!*

VINTAGE SYNTH M-VS1

取扱説明書
Owner's Manual

はじめに

このたびは、ローランド サウンド・エクspansion・シリーズ「M-VS1」をお買い上げいただきまして、ありがとうございます。本機の優れた機能と音質を十分にご理解いただき、未永く愛用していただくために、この取扱説明書とサウンド・エクspansion・シリーズ取扱説明書を良くお読みくださるようお願い申し上げます。

本書ではM-VS1に内蔵されているパッチ、パフォーマンスなどについて解説しています。操作方法やエラー・メッセージなどについてはサウンド・エクspansion・シリーズ取扱説明書をご覧ください。

主な特長

- M-VS1は、SH-1000からD-50に至る歴代のローランド・シンセサイザーはもちろん、内外の名器と呼ばれる往年のビンテージ・シンセサイザーの中から厳選した255種類の高品位な音色を内蔵しています。
- ビンテージ・シンセの音色以外にも、ローランドTR-808/CR-78からエレクトリック・ドラムまで計8種類のリズム・セットを内蔵しています。
- ライブでの演奏に適したパッチ・モードと、シーケンサーを使った自動演奏に適したパフォーマンス・モードがあります。
- リバースとコーラスのエフェクトにより、コンサート・ホールで演奏しているような音の広がりを出したり、音作りの機能として活用できます。
- インプット・ジャックを装備していますので、ミキサーなどを用意しなくても他の音源の出力とミックスしてアウトプット・ジャックから出力できます。
- GMシステム/ GSフォーマットのミュージック・データを利用する際に便利な音色配列も用意しています。



Introduction

Thank you, and congratulations on your choice of the Roland M-VS1 Sound Expansion Series. To take full advantage of the M-VS1's convenient features and extraordinary sounds, please take the time to read this manual and the Sound Expansion Series Owner's Manual.

This manual explains the unique functions and built-in Patches and Performances of the M-VS1, a sound module in the Sound Expansion Series. For details on how to operate it, or a list of error messages, you should refer to the Sound Expansion Series Owner's Manual.

Features

- The M-VS1 provides a virtual warehouse full of vintage instrument sounds. While of course providing Waveforms from every Roland synthesizer that has enjoyed acclaim in the past (from the SH-1000 to the D-50), it also offers sounds from almost all the other synthesizers of importance that have appeared on the world scene in recent decades. What's more, only the best 255 Patches were carefully selected for inclusion.
- Also offers eight rhythm sets which provide sounds from Roland's TR-808, CR-78, and a variety of electric drums.
- The M-VS1 offers two modes: the "Patch" mode (which is ideal for playing live), and the "Performance" mode, which is the normal mode to use when playing the module using a sequencer.
- Comes with an effects processor (reverb and chorus), so you can try your hand at applying a full range of modifications, and enjoy the sonic illusion of playing in a large concert hall!
- An input jack allows you to route sound from another device to this unit and have both be mixed, thus eliminating the need for separate mixing equipment.
- Offers a selection of sound mappings, so music data for the General MIDI System/GS Format can be conveniently enjoyed.

 CAUTION RISK OF ELECTRIC SHOCK DO NOT OPEN	
ATTENTION: RISQUE DE CHOC ELECTRIQUE NE PAS OUVRIIR	
CAUTION: TO REDUCE THE RISK OF ELECTRIC SHOCK, DO NOT REMOVE COVER (OR BACK). NO USER-SERVICEABLE PARTS INSIDE. REFER SERVICING TO QUALIFIED SERVICE PERSONNEL.	



The lightning flash with arrowhead symbol, within an equilateral triangle, is intended to alert the user to the presence of uninsulated "dangerous voltage" within the product's enclosure that may be of sufficient magnitude to constitute a risk of electric shock to persons.



The exclamation point within an equilateral triangle is intended to alert the user to the presence of important operating and maintenance (servicing) instructions in the literature accompanying the product.

INSTRUCTIONS PERTAINING TO A RISK OF FIRE, ELECTRIC SHOCK, OR INJURY TO PERSONS.

IMPORTANT SAFETY INSTRUCTIONS SAVE THESE INSTRUCTIONS

WARNING - When using electric products, basic precautions should always be followed, including the following:

1. Read all the instructions before using the product.
2. Do not use this product near water — for example, near a bathtub, washbowl, kitchen sink, in a wet basement, or near a swimming pool, or the like.
3. This product should be used only with a cart or stand that is recommended by the manufacturer.
4. This product, either alone or in combination with an amplifier and headphones or speakers, may be capable of producing sound levels that could cause permanent hearing loss. Do not operate for a long period of time at a high volume level or at a level that is uncomfortable. If you experience any hearing loss or ringing in the ears, you should consult an audiologist.
5. The product should be located so that its location or position does not interfere with its proper ventilation.
6. The product should be located away from heat sources such as radiators, heat registers, or other products that produce heat.
7. The product should be connected to a power supply only of the type described in the operating instructions or as marked on the product.
8. The power-supply cord of the product should be unplugged from the outlet when left unused for a long period of time.
9. Care should be taken so that objects do not fall and liquids are not spilled into the enclosure through openings.
10. The product should be serviced by qualified service personnel when:
 - A. The power-supply cord or the plug has been damaged; or
 - B. Objects have fallen, or liquid has been spilled onto the product; or
 - C. The product has been exposed to rain; or
 - D. The product does not appear to operate normally or exhibits a marked change in performance; or
 - E. The product has been dropped, or the enclosure damaged.
11. Do not attempt to service the product beyond that described in the user-maintenance instructions. All other servicing should be referred to qualified service personnel.

For the USA

GROUNDING INSTRUCTIONS

This product must be grounded. If it should malfunction or breakdown, grounding provides a path of least resistance for electric current to reduce the risk of electric shock.

This product is equipped with a cord having an equipment-grounding conductor and a grounding plug. The plug must be plugged into an appropriate outlet that is properly installed and grounded in accordance with all local codes and ordinances.

DANGER: Improper connection of the equipment-grounding conductor can result in a risk of electric shock. Check with a qualified electrician or serviceman if you are in doubt as to whether the product is properly grounded.

Do not modify the plug provided with the product — if it will not fit the outlet, have a proper outlet installed by a qualified electrician.

For the U.K.

WARNING: THIS APPARATUS MUST BE EARTHED

IMPORTANT: THE WIRES IN THIS MAINS LEAD ARE COLOURED IN ACCORDANCE WITH THE FOLLOWING CODE.
GREEN-AND-YELLOW: EARTH, BLUE: NEUTRAL, BROWN: LIVE

As the colours of the wires in the mains lead of this apparatus may not correspond with the coloured markings identifying the terminals in your plug, proceed as follows:

The wire which is coloured GREEN-AND-YELLOW must be connected to the terminal in the plug which is marked by the letter E or by the safety earth symbol  or coloured GREEN or GREEN-AND-YELLOW.

The wire which is coloured BLUE must be connected to the terminal which is marked with the letter N or coloured BLACK.

The wire which is coloured BROWN must be connected to the terminal which is marked with the letter L or coloured RED.

The product which is equipped with a THREE WIRE GROUNDING TYPE LINE PLUG must be grounded.

安全にお使いいただくために

この製品の取り扱いについては、次の基本的な安全事項に、ご注意ください。

- 次のような場所でのご使用や保存は、故障の原因となりますので、ご注意ください。
 - 温度が極端に高い場所（直射日光の当たる場所、暖房機器の近く、発熱する機器の上など）
 - 水気の近く（風呂場、洗面台、濡れた床など）や湿度の高い場所
 - ホコリの多い場所
 - 振動の多い場所
- 電源プラグは、必ずAC100Vの電源コンセントに差し込んでください。
- 電源コードの上に重いものをのせたり、踏みつけたりして傷をつけないでください。
- 電源プラグをコンセントから抜く場合は、電源コードの断線やショートによる危険防止のため、必ず電源プラグを持ってください。
- 長時間使用しない場合は、電源プラグをコンセントから抜いてください。
- 本機には、異物（硬貨や針金など）や液体（水やジュースなど）が入らないように注意してください。
- 感電や故障の原因になりますので、本機の内部に手を入れたり、改造しないでください。
- 本機に異常や故障が生じた場合は、直ちに使用を中止し、お買い上げ店またはローランド・サービスにご連絡ください。

ご使用上の注意

表紙裏に記載されている安全事項以外に、次のことにご注意ください。

■電源について

- 他の機器と接続する際は、誤動作やスピーカーなどの破損を防ぐため、必ずすべての機器の電源をオフにしてください。
- 雑音を発生する装置（モーター、調光器など）や消費電力の大きな機器とは、別のコンセントをご使用ください。

■設置について

- 本機の近くにパワー・アンプなどの大型トランスを持つ機器がある場合、ハム（うなり）を誘導することがあります。その場合は、本機との間隔や方向を変えてください。
- テレビやラジオの近くで本機を動作させると、テレビ画面に色ムラが出たり、ラジオから雑音が出ることがあります。このような場合は、本機を遠ざけてご使用ください。

■お手入れについて

- 通常のお手入れは、柔らかい布で空拭きするか、堅く絞った布で汚れを拭き取ってください。汚れが激しいときは、中性洗剤で汚れを拭き取ってから、必ず柔らかい布で空拭きしてください。
- 変色や変形の原因となるベンジン、シンナー及びアルコール類は、絶対にご使用にならないでください。

■その他の注意について

- 本機に強い衝撃を与えないでください。
- ディスプレイを強く押ししたり、叩いたりしないでください。
- 本機は多少発熱することがありますが、故障ではありません。
- 外国でご使用になる場合は、前もって最寄りのローランド・サービスにご相談ください。
- ディスプレイから多少音がすることがありますが、故障ではありません。

■メモリー・バックアップについて

- 本体には、電源オフ後も記憶した内容を保持するための電池を装備しています。5年を目安に交換してください（電池の寿命は使用条件によって異なります）。交換の際は、必ずローランド・サービスにご相談ください。
- 電池が消耗してくると、ディスプレイに次のように表示されます。電池が消耗してしまうと記憶した内容が失われますので、早めに交換してください。

b t L

- 修理に出される場合や万一異常な動作をしたときには、記憶した内容が失われることがあります。大切なデータは、他のMIDI機器（シーケンサーなど）に保存するか、データをメモしておいてください。修理の際のデータ保存には細心の注意を払っておりますが、メモリー部の故障などでデータが復元できない場合はご容赦ください。

Important Notes

In addition to the items listed under Important Safety Instructions inside the front cover, please read and observe the following:

Power Supply

- Before connecting this unit to other devices, turn off the power to all units; this will help prevent damage or malfunction.
- Do not use this unit on the same power circuit with any device that will generate line noise; an electric motor or variable lighting system for example.

Placement

- Using the unit near power amplifiers (or other equipment containing large power transformers) may induce hum.
- This device may interfere with radio and television reception. Do not use this device in the vicinity of such receivers.

Maintenance

- For everyday cleaning wipe the unit with a soft, dry cloth or one that has been slightly dampened with water. To remove stubborn dirt, use a mild, non-abrasive detergent. Afterwards, be sure to wipe the unit thoroughly with a soft, dry cloth.
- Never use benzene, thinners, alcohol or solvents of any kind, to avoid the possibility of discoloration and/or deformation.

Additional Precautions

- Protect the unit from strong impact.
- Never strike or apply strong pressure to the display.
- A small amount of heat will radiate from the unit during normal operation.
- Before using the unit in a foreign country, consult with qualified service personnel.
- A small amount of noise may be heard from the display during normal operation.

Memory Backup

- This unit contains a battery which powers the unit's memory circuits while the main (AC) power is off. The expected life of this battery is 5 years or more. However, to avoid the untimely loss of memory data, it is strongly recommended that you change the battery every 5 years. Please be aware that the actual life of the battery will depend upon the physical environment — especially the temperature — in which the unit is used. When it is time to change the battery, consult with qualified service personnel.
- When the battery becomes weak the following message will appear in the display: "b t L ." Please change the battery as soon as possible to avoid the loss of memory data.
- Please be aware that the contents of memory may at times be lost; when the unit is sent for repairs or when by some chance a malfunction has occurred. Important data should be stored in another MIDI device (eg., a sequencer), or written down on paper (if possible). During repairs, due care is taken to avoid the loss of data. However, in certain cases (such as when circuitry related to memory itself is out of order), we regret that it may not be possible to restore the data.

デモ曲について

About the Demo Songs

M-VS1には3曲のデモ曲が内蔵されています。曲名と作曲者などは以下の通りです。デモ曲をお聴きになりたいときは、サウンド・エクステンション・シリーズ取扱説明書の「デモ曲の聴き方」(p.6)をご覧ください。

Contained within the M-VS1 are three demo songs. The names of these songs and their composers are listed below. See page 6 in the Sound Expansion series Owner's Manual for instructions on how to listen to the demo songs.

曲番号	S-1
曲名	The Code
作曲者	坂上暢
著作権	© 1995 ローランド
使用パッチ	5, 29, 57, 62, 65, 67, 70, 96, 99, 103, 115, 133, 156, 161, 167, 186, 208, 234, 250
使用リズム・セット	d 6

Song No.	S-1
Song title	The Code
Composer	Mitsuru Sakaue
Copyright	© 1995 Roland Corporation
Patches	5, 29, 57, 62, 65, 67, 70, 96, 99, 103, 115, 133, 156, 161, 167, 186, 208, 234, 250
Rhythm Set	d 6

曲番号	S-2
曲名	Eyes
作曲者	秘田陽啓
著作権	© 1995 ローランド
使用パッチ	19, 62, 63, 65, 73, 96, 110, 118, 190, 217, 252, 254
使用リズム・セット	d 7

Song No.	S-2
Song title	Eyes
Composer	Akihiro Kaseda
Copyright	© 1995 Roland Corporation
Patches	19, 62, 63, 65, 73, 96, 110, 118, 190, 217, 252, 254
Rhythm Set	d 7

曲番号	S-3
曲名	The Tardis
作曲者	エイドリアン・スコット
著作権	© 1995 ローランド
使用パッチ	1, 6, 30, 36, 38, 50, 57, 65, 68, 78, 85, 86, 89, 90, 96, 122, 126, 154, 160, 165, 186, 198, 202, 208, 210, 217, 245, 246, 248, 249, 251, 254
使用リズム・セット	d 8

Song No.	S-3
Song title	The Tardis
Composer	Adrian Scott
Copyright	© 1995 Roland Corporation
Patches	1, 6, 30, 36, 38, 50, 57, 65, 68, 78, 85, 86, 89, 90, 96, 122, 126, 154, 160, 165, 186, 198, 202, 208, 210, 217, 245, 246, 248, 249, 251, 254
Rhythm Set	d 8

■ 作曲者のプロフィール.....

■ Biographies of Composers

坂上暢 (さかうえ みつる)
大学在学中より、キーボード・プレーヤー、アレンジャーとして数々のスタジオ・ワークやCM等の音楽制作にたずさわり、現在はコンポーザー、アレンジャー、キーボード・プレーヤー、コンピューター・ミュージックのエキスパートとして、TV、ラジオ等のCM音楽制作、音楽専門誌への執筆とあらゆるメディアで活躍中。ジャンルを問わない幅広い音楽性は高い評価を受けている。音楽クリエイター集団(株) アイデックスのチーフ・ディレクター。

Mitsuru Sakaue

From his college days, Mitsuru Sakaue has been active as a keyboard player and arranger in studio and commercial music production. At present he is involved in production of commercials for TV and radio as a composer, arranger, keyboard player and computer music expert. His highly acclaimed musical abilities go beyond borders of musical genre. He is the chief director of the Idexs (Inc.) group of creative musical artists.

秘田陽啓 (かせだ あきひろ)
大阪在住のキーボード奏者、作、編曲家。CMやイベントの音楽を主に手掛けつつ、シンセサイザーおよびシーケンサーのプログラミングもこなすレンジの広い音楽家である。もんだよしのり、桑名正博、桑名晴子 etc. とのバンド活動を通じてディープなR&Bにどっぷりと漬かる一方、モーツァルトをこよなく愛する、という一面も持ち、独自の音楽観と音楽性で、セッション・ミュージシャンとしてスタジオ・ワーク、ライブ演奏などで幅広く活躍している。ローランドでは、音色、デモ曲を数多く手掛けている他、新製品のデモ演奏で全国各地を飛び回っている。

Akihiro Kaseda

Akihiro Kaseda is a keyboardist, composer and arranger based in Osaka, Japan. Well versed in the programming of synths and sequencers, he continually works on broadening his already wide range of styles. While playing with some of Japan's top R&B bands, he developed a good feel for popular music -- though he admits that Mozart still remains his favorite source of inspiration. Currently, his individualistic musical sensibilities are becoming increasingly more widely expressed through his activities as a session musician and live performer. With Roland, he not only has created numerous sounds and demo songs, but also has been kept busy flying all over Japan as a demonstrator of new products.

Adrian Scott (エイドリアン・スコット)
数々のヒット曲を生んだオーストラリアのポップ・グループ“エア・サプライ”でキーボードとボーカルを担当。ソロ活動に転じてからは、1984年に“World Song Festival Tokyo '84”で銀賞受賞。現在、コマーシャル音楽や映画音楽のプロデューサーとして活躍している。また、セッション・プレーヤーとしてジョン・ファナム (John Farnham) やカイリー・ミノグ (Kylie Minogue) など、数多くのオーストラリアの有名ミュージシャンと共演している。オーストラリア、メルボルン在住。

Adrian Scott

Adrian Scott formerly handled the vocals and keyboards for the popular Australian group, "Air Supply." Since following the solo path, he won the Silver Prize at the "World Song Festival Tokyo '84." Currently, he is involved as a producer of commercial music and music for films. In addition, as a session player, he has performed along with a number of Australia's top musicians, including John Farnham and Kylie Minogue. He lives in Melbourne, Australia.

*これらのデモ曲を個人で楽しむ以外に権利者の許諾なく使用することは、法律で禁じられています。

* All rights reserved. Unauthorized use of this material is a violation of applicable laws.

音色一覧表 / Tone List

各リストの解説は p. 10 をご覧ください。 / For information that will help you better understand these lists, see page 11.

パフォーマンス一覧表

Performance List

<PC No.1: P01 Vintage Kit1>

Part	No.	Patch Name
1	138	P5 Sync Lead
2	177	ClassicMG Bs
3	32	CS Saw Pad
4	122	OB Stab Brs
5	63	Tron Strings
6	44	VP-330 Choir
7	217	MCB Sequence
8	d 2	Electric 1

Reverb: Hall 1; Chorus: Chorus 1

<PC No.2: P02 Vintage Kit2>

Part	No.	Patch Name
1	140	Mini Lead 1
2	194	TB303 Bs
3	155	Arpy Micro
4	108	OBIG Poly
5	70	Velv Rotary
6	25	JP8 Strings1
7	102	SH-1000 MIDI
8	d 5	CR-78

Reverb: Room 1; Chorus: Chorus 1

<PC No.3: P03 Power Trance>

Part	No.	Patch Name
1	183	Talking Bs
2	180	101 Ow Bass
3	195	TB303 AcidBs
4	178	Reso MG Bass
5	239	Resotrails
6	47	JP6 Bend 5th
7	38	RealEnsemble
8	d 4	TR-808

Reverb: Room 2; Chorus: Chorus 2

<PC No.4: P04 Hard Core>

Part	No.	Patch Name
1	254	Faveoravo
2	204	Techno Bass
3	137	P5 Sync Rush
4	255	Medusa
5	19	MachineDream
6	92	Hyper Clav
7	210	Techno Perc
8	d 5	CR-78

Reverb: Stage 1; Chorus: Chorus 2

<PC No.5: P05 Ambient>

Part	No.	Patch Name
1	167	70s Sinusolo
2	206	Housine Bass
3	244	Cyborg
4	238	Analog Chime
5	249	Choronos
6	252	Aquaphone
7	51	Voices JX-8P
8	d 4	TR-808

Reverb: Hall 1; Chorus: Chorus 2

<PC No.6: P06 Electric Pop>

Part	No.	Patch Name
1	155	Arpy Micro
2	187	SH101 Zap Bs
3	209	Thips Blips
4	93	DrQ 106 Clav
5	214	ArpeggiSaws
6	232	Snow Lake
7	253	Computer Net
8	d 2	Electric 1

Reverb: Room 2; Chorus: Chorus 1

<PC No.7: P07 Progressive>

Part	No.	Patch Name
1	145	CS Lead
2	208	Midi X Bass
3	68	Power 8
4	143	Mini Lead 4
5	218	RM Piano 1
6	120	Spit Brass
7	61	Real Mellow
8	d 3	Electric 2

Reverb: Hall 2; Chorus: Chorus 1

<PC No.8: P08 Synth Orch>

Part	No.	Patch Name
1	65	StrawberyFlt
2	184	MG Bs Pedals
3	172	GR500 SlowLd
4	57	Tron Choir
5	28	Analog Orch
6	127	Quack Brass
7	243	Space Echo
8	d 1	Standard

Reverb: Hall 2; Chorus: Chorus 1

<PC No.9: P09 Hard Rock>

Part	No.	Patch Name
1	142	Mini Lead 3
2	207	Super Bass
3	122	OB Stab Brs
4	71	DistOrganFXM
5	135	Rock Sync
6	110	Thick Matrix
7	30	OB Thick Pad
8	d 1	Standard

Reverb: Stage 2; Chorus: Chorus 2

<PC No.10: P10 The Code>

Part	No.	Patch Name
1	62	OctMelotron
2	186	Bassic 101
3	5	JX3P Polaris
4	167	70s Sinusolo
5	96	Perkolator
6	219	Wurlisynth
7	65	StrawberyFlt
8	d 6	The Code

Reverb: Hall 1; Chorus: Chorus 2

<PC No.11: P11 Eyes>

Part	No.	Patch Name
1	110	Thick Matrix
2	73	Organwave2.2
3	96	Perkolator
4	190	JP-4 Bass 2
5	19	MachineDream
6	118	MIDI Brs Pad
7	254	Faveoravo
8	d 7	Eyes

Reverb: Stage 2; Chorus: Chorus 1

<PC No.12: P12 The Tardis>

Part	No.	Patch Name
1	85	Clavipad
2	198	Woofier Bass
3	90	JP-8 Clav
4	36	Solina
5	126	MKS-7 Brass
6	86	P10 GuitClav
7	249	Chronos
8	d 8	The Tardis

Reverb: Hall 1; Chorus: Chorus 1

<PC No.13: P13 Delay>

Part	No.	Patch Name
1	152	Syn Lead Ma
2	156	OB 2 Voice
3	136	T8 Sync
4	144	VCO Oct Lead
5	73	Organwave2.2
6	111	Prophetic
7	94	Perky Pad
8	d 4	TR-808

Reverb: Delay; Chorus: Chorus 1

<PC No.14: P14 Pan-Delay>

Part	No.	Patch Name
1	150	SH Solo
2	166	FM Lead
3	149	The Melody
4	241	Random Chime
5	231	Kalimbasynt
6	9	PG Ominous
7	31	FullOut Saws
8	d 3	Electric 2

Reverb: Pan-Delay; Chorus: Chorus 3

<PC No.15: P15 Flanger>

Part	No.	Patch Name
1	152	Syn Lead Ma
2	170	MultiMG 5ths
3	24	JX-3P Planet
4	96	Perkolator
5	12	WavetablePan
6	35	MemoryMg STR
7	104	CS-Sixty BPF
8	d 5	CR-78

Reverb: Hall 2; Chorus: Chorus 2

<PC No.16: P16 layer Sound>

Part	No.	Patch Name
1	254	Faveoravo
2	217	MCB Sequence
3	107	OB Synth
4	2	Mega 5ths
5	249	Choronos
6	1	Prologue
7	1	Prologue
8	d 1	Standard

Reverb: Hall 1; Chorus: Chorus 1

<PC No.17: P17 Default Perf>

Part	No.	Patch Name
1	1	Prologue
2	1	Prologue
3	1	Prologue
4	1	Prologue
5	1	Prologue
6	1	Prologue
7	1	Prologue
8	d 1	Standard

Reverb: Stage 1; Chorus: Chorus 1

PC No.:

プログラム・ナンバー
(パフォーマンス・ナンバー)

Program Number
(Performance Number)

No.:

パッチ・ナンバーまたは
リズム・セット・ナンバー

Patch Number
(Rhythm set Number)

音色一覧表 / Tone List

パッチ一覧表 Patch List

■CCO: 80; CC32: 0

No.	PC No.	Name	Voice	No.	PC No.	Name	Voice	No.	PC No.	Name	Voice	No.	PC No.	Name	Voice	No.	PC No.	Name	Voice
1	1	Prologue	3	27	27	PWM Strings	4	53	53	Somewhere	2	79	79	Juno60 Organ	1	104	104	CS-Sixty BPF	2
2	2	Mega 5ths	4	28	28	Analog Orch	3	54	54	JX Melon Vox	3	80	80	JX-8P Organ	1	105	105	Waspy Synth	2
3	3	Shine on you	1	29	29	Big Strings	3	55	55	Swell Vox	2	81	81	D-50 Organ 1	3	106	106	Polychrome	3
4	4	Converge	2	30	30	OB Thick Pad	3	56	56	VP-330 Sweep	2	82	82	D-50 Organ 2	2	107	107	OB Synth	2
5	5	JX3P Polaris	1	31	31	FullOut Saws	2	57	57	Tron Choir	1	83	83	2600 Clk Org	2	108	108	OBIG Poly	3
6	6	Big Pad Swp	2	32	32	CS Saw Pad	3	58	58	ChoirSynths	2	84	84	JX-3P Pipes	3	109	109	80s OBxa	2
7	7	Big LFOSweep	2	33	33	CS Strings	4	59	59	Misty Choir	2	85	85	Clavipad	3	110	110	Thick Matrix	3
8	8	The Big Wave	3	34	34	OctavaStrngs	3	60	60	Etherial	2	86	86	P10 GuitClav	2	111	111	Prophetic	3
9	9	PG Ominous	2	35	35	MemoryMG STR	2	61	61	Real Mellow	1	87	87	Gum Clav	2	112	112	Oct MG Saw	2
10	10	Wavestrings	2	36	36	Solina	1	62	62	OctMelatron	3	88	88	JunoBiteClav	1	113	113	CS Power Saw	3
11	11	Mantrawave	4	37	37	RS202 String	3	63	63	Tron Strings	1	89	89	Phazyn Clav	2	114	114	Juno-6 Power	2
12	12	WavetablePan	3	38	38	RealEnsemble	1	64	64	Melatron Pad	2	90	90	JP-B Clav	2	115	115	Hyperphases	2
13	13	Euro Sweep	2	39	39	Rhapsody STR	1	65	65	StrawberyFlt	1	91	91	Alpha Clav	2	116	116	Synth-X Phaz	3
14	14	Metal Drone	2	40	40	Juno 106 Pad	2	66	66	MellowFlutes	2	92	92	Hyper Clav	2	117	117	Synth-X Poly	2
15	15	EasternTempl	4	41	41	Orchestrator	2	67	67	DarkEnsemble	2	93	93	DrQ 106 Clav	1	118	118	MIDI Brs Pad	2
16	16	Shining Wave	2	42	42	VP-330 Tutti	3	68	68	Power B	2	94	94	Perky Pad	3	119	119	Poly X-pandr	2
17	17	DigitalChoir	2	43	43	LonesomeHill	2	69	69	DirtyPurple	2	95	95	Poly Palette	2	120	120	Spit Brass	2
18	18	Warm Shimmer	2	44	44	VP-330 Choir	2	70	70	Velo Rotary	2	96	96	Perkolator	2	121	121	Pro-10 Brass	2
19	19	MachineDream	4	45	45	Girls Choir	3	71	71	DistOrganFXM	2	97	97	Poly Flange	2	122	122	OB Stab Brs	2
20	20	Replicants	4	46	46	HollowBreath	2	72	72	Gospel B	2	98	98	MondoDiGiTal	2	123	123	Pro-5 Brass	1
21	21	Random Pad	2	47	47	JP6 Bend 5th	2	73	73	Organwave2.2	2	99	99	and thenMIDI	3	124	124	P5/MG Brass	2
22	22	Animation	4	48	48	JP SquarePad	3	74	74	VS Organ	2	100	100	MKS80 Sprang	2	125	125	MKS80 Brass	2
23	23	Nervous Pan	2	49	49	Hollow JX	2	75	75	VS Organbell	2	101	101	JP4Sharp Pad	4	126	126	MKS-7 Brass	2
24	24	JX-3P Planet	2	50	50	JX Vox	2	76	76	VK-1 Organ	2	102	102	SH-1000 MIDI	3	127	127	Quack Brass	1
25	25	JPB Strings1	2	51	51	Voices JX-8P	2	77	77	Celesty Juno	2	103	103	Splatty	3	128	128	FM Brass	1
26	26	JP+OB Strngs	3	52	52	DSO Heavenly	1	78	78	Alpharphisa	2								

■CCO: 81; CC32: 0

No.	PC No.	Name	Voice	No.	PC No.	Name	Voice	No.	PC No.	Name	Voice	No.	PC No.	Name	Voice	No.	PC No.	Name	Voice
129	1	Dark Brass	3	155	27	Arpy Micro	1	181	53	Wet MG Bass	1	206	78	Housine Bass	1	231	103	Kalimbosynth	3
130	2	MemoryMG Brs	2	156	28	OB 2 Voice	2	182	54	2600 Reso Bs	2	207	79	Super Bass	1	232	104	Snow Lake	3
131	3	SH2 Brass	3	157	29	2 Voice Solo	2	183	55	Talking Bs	2	208	80	Midi X Bass	2	233	105	Tower Silvis	2
132	4	RS-202 Brass	3	158	30	ClassicLead	1	184	56	MG Bs Pedals	2	209	81	Thips Blips	2	234	106	Time flies	2
133	5	Polysync	2	159	31	Shmoog	2	185	57	Rogue Bass	2	210	82	Techno Perc	2	235	107	Juno-1 Bells	2
134	6	Wavesync	2	160	32	Lucky Man	2	186	58	Bassic 101	1	211	83	2.3 GlassSEQ	2	236	108	GoodniteBell	3
135	7	Rock Sync	3	161	33	ModularLead	2	187	59	SH101 Zap Bs	2	212	84	Planet-S SEQ	2	237	109	2600 TRBell	4
136	8	T8 Sync	3	162	34	Jupiter Lead	1	188	60	101 Oct Bass	1	213	85	ArpeggiBs+12	4	238	110	Analog Chime	4
137	9	P5 Sync Rush	2	163	35	Micro MG	1	189	61	JP-4 Bass 1	1	214	86	ArpeggiSaws	4	239	111	Resotrails	3
138	10	P5 Sync Lead	2	164	36	Pulse Lead	2	190	62	JP-4 Bass 2	1	215	87	Descender	4	240	112	Additive	3
139	11	Synkoid	2	165	37	SH-2000 Vox	1	191	63	System700 Bs1	2	216	88	Playmate	4	241	113	Random Chime	2
140	12	Mini Lead 1	1	166	38	FM Lead	2	192	64	System700 Bs2	2	217	89	MCSB Sequence	3	242	114	Asia Wave	2
141	13	Mini Lead 2	2	167	39	70s Sinusolo	3	193	65	SH-2 Bass	2	218	90	RM Piano 1	3	243	115	Space Echo	4
142	14	Mini Lead 3	2	168	40	Alpha Lead	2	194	66	TB303 Bs	1	219	91	Wurlisynth	2	244	116	Cyborg	2
143	15	Mini Lead 4	2	169	41	MG Swell	3	195	67	TB303 AcidBs	1	220	92	Syn E.P. 1	3	245	117	MKS80 Vortex	2
144	16	VCO Oct Lead	1	170	42	MultiMG 5ths	3	196	68	Odyssey Bs	1	221	93	AnaSyn E.P.	3	246	118	Earthquake	1
145	17	CS Lead	2	171	43	Retrosweep	4	197	69	House Bass	1	222	94	Synth Vibe	2	247	119	Airdrome Pan	4
146	18	Expressolo	1	172	44	GR500 SlowLd	1	198	70	Woofar Bass	2	223	95	Ring Piano 1	4	248	120	Deep Wind	1
147	19	Pats GR-300	2	173	45	OB Bass	2	199	71	Spike Bass	2	224	96	Ring Piano 2	4	249	121	Chronos	4
148	20	Promars Lead	3	174	46	MG Beef Bass	3	200	72	Big Spike Bs	3	225	97	DSO Bellpad1	4	250	122	Infinity	4
149	21	The Melody	4	175	47	Monster MG	2	201	73	Sharp Sub Bs	2	226	98	DSO Bellpad2	4	251	123	Atmosphlange	2
150	22	SH Solo	2	176	48	Fat MG Bass	2	202	74	Big Sub Bass	2	227	99	DSO Bellpad3	3	252	124	Aquaphone	2
151	23	Wagnerian Ld	3	177	49	ClassicMG Bs	2	203	75	System100 Bs	3	228	100	Bell Pad	2	253	125	Computer Net	2
152	24	Syn Lead Ma	3	178	50	Reso MG Bass	2	204	76	Techno Bass	2	229	101	Fanta-Retro	4	254	126	Favearavo	4
153	25	Naked Cheese	1	179	51	MG Ow Bass	1	205	77	Bark Bass	2	230	102	SimpleEP+Pad	3	255	127	Medusa	4
154	26	Telstar	2	180	52	101 Ow Bass	1												

音色テーブル2一覧表
Patch Table2 List

■ Part 1 — 7

<Piano>

PC No.	CC0	CC32	Patch No.	Patch Name	Voice
5	0	0	219	Wurlisynth	2
	8	0	220	Syn E.P. 1	3
	16	0	223	Ring Piano 1	4
	24	0	221	AnaSyn E.P.	3
6	0	0	218	RM Piano 1	3
	8	0	224	Ring Piano 2	4
	16	0	230	SimpleEP+Pad	3

<Organ>

PC No.	CC0	CC32	Patch No.	Patch Name	Voice
17	0	0	76	VK-1 Organ	2
	8	0	73	Organwave2.2	2
	16	0	78	Alpharphisa	2
	32	0	74	VS Organ	2
18	0	0	68	Power B	2
	8	0	70	Velo Rotary	2
	32	0	72	Gospel B	2
19	0	0	81	D-50 Organ 1	3

<Bass>

PC No.	CC0	CC32	Patch No.	Patch Name	Voice
39	0	0	193	SH-2 Bass	2
	1	0	180	101 Dw Bass	1
	8	0	182	2600 Reso Bs	2
40	0	0	185	Rogue Bass	2
	8	0	208	Midi X Bass	2
	16	0	183	Talking Bs	2

<Ensemble>

PC No.	CC0	CC32	Patch No.	Patch Name	Voice
49	0	0	38	RealEnsemble	1
	8	0	41	Orchestrator	2
50	0	0	28	Analog Orch	3
51	0	0	37	RS202 String	3
	8	0	39	Rhapsody STR	1
52	0	0	27	PWM Strings	4
53	0	0	61	Real Mellow	1
	32	0	58	ChoirSynths	2
54	0	0	53	Somewhere	2
55	0	0	46	HollowBreath	2
56	0	0	254	Faveoravo	4

PC No.: プログラム・ナンバー
Program Number
CC0: コントローラー・ナンバー0の値
Value of Controller Number 0
CC32: コントローラー・ナンバー32の値
Value of Controller Number 32
R. Set: リズム・セット
Rhythm Set
Voice: 使用ボイス数
Number of Voices
---: 無視されます
Ignored

<Brass>

PC No.	CC0	CC32	Patch No.	Patch Name	Voice
63	0	0	122	OB Stab Brs	2
	8	0	125	MKS80 Brass	2
	16	0	127	Quack Brass	1
64	0	0	129	Dark Brass	3
	8	0	128	FM Brass	1
	16	0	120	Spit Brass	2

<Pipe>

PC No.	CC0	CC32	Patch No.	Patch Name	Voice
74	0	0	65	StrawberyPi	1

<Synth Lead>

PC No.	CC0	CC32	Patch No.	Patch Name	Voice
81	0	0	160	Lucky Man	2
	1	0	155	Arpy Micro	1
	8	0	167	70s Sinusolo	3
82	0	0	107	OB Synth	2
	1	0	150	SH Solo	2
	8	0	114	Juno-6 Power	2
83	0	0	234	Time flies	2
84	0	0	151	Wagnerian Ld	3
85	0	0	133	Polysync	2
86	0	0	156	OB 2 Voice	2
87	0	0	170	MultiMg Sths	3
88	0	0	186	Bassic 101	1

<Synth Pad>

PC No.	CC0	CC32	Patch No.	Patch Name	Voice
89	0	0	228	Bell Pad	2
90	0	0	25	JPB Strings1	2
91	0	0	109	80s OBxa	2
92	0	0	44	VP-330 Choir	2
93	0	0	9	PG Ominous	2
94	0	0	3	Shine on you	1
95	0	0	52	D50 Heavenly	1
96	0	0	7	Big LFOSweep	2

■ Part 8

PC No.	CC0	CC32	R. Set No.	R. Set Name
1	---	---	d 1	Standard
25	---	---	d 2	Electric 1
26	---	---	d 4	TR-808

リズム・セット一覧表
Rhythm Set List (CC0: 80; CC32: 0)

<PC No.1: d 1 Standard>

Key	Note No.	Rhythm Tone Name
C2	36	Verb Kick
G#2	37	Cross Stick
D2	38	90's Snare
D#2	39	808 Claps
E2	40	Piccolo Snare
F#2	41	Power Tom Low 2
G2	42	Closed Hi-Hat 1 [EXC1]
G2	43	Power Tom Low 1
G#2	44	Closed Hi-Hat 2 [EXC1]
A2	45	Power Tom Mid 2
A#2	46	Open Hi-Hat [EXC1]
B2	47	Power Tom Mid 1
C3	48	Power Tom Hi 2
G#3	49	Crash Cymbal 1
D3	50	Power Tom Hi 1
D#3	51	Ride Cymbal 1
E3	52	Crash Cymbal 2
F3	53	Ride Bell 1
F#3	54	Tambourine
G3	55	Crash Mute
G#3	56	Cowbell 1
A3	57	Crash Cymbal 3
A#3	58	Vibra-Slap
B3	59	Crash Cymbal 4
C4	60	Conga Mute High
C#4	61	Conga Mute Low
D4	62	Conga Slap
D#4	63	Conga High
E4	64	Conga Low
F4	65	Rim Shot 1
F#4	66	Rim Shot 2
G4	67	Agogo High
G#4	68	Agogo Low
A4	69	Cabasa
A#4	70	Maracas
B4	71	Noise Fx Mute [EXC2]
C5	72	Noise Fx [EXC2]
C#5	73	ZZZ loop Mute [EXC3]
D5	74	ZZZ loop [EXC3]
D#5	75	808 Claves
E5	76	CR78 Bongo High
F5	77	CR78 Bongo Low
F#5	78	X-modulation 1 [EXC4]
G5	79	X-modulation 2 [EXC4]
G#5	80	Ride Bell Mute [EXC5]
A5	81	Ride Bell 2 [EXC5]
A#5	82	REV Steam Drum [EXC1]
B5	83	REV 909 Kick
C6	84	Electric Kick
C#6	85	808 Snare
D6	86	SIM Snare
D#6	87	CR78 Open HH
E6	88	909 Snare
F6	89	CR78 Cowbell 1
F#6	90	CR78 Tambourine
G6	91	CR78 Cowbell 2
G#6	92	808 Cowbell
A6	93	808 Conga Low
A#6	94	Pink Noise Fx
B6	95	808 Conga High
C7	96	REV Blip

<PC No.2: d 2 Electric 1>

Key	Note No.	Rhythm Tone Name
C2	36	Electric Kick
G#2	37	Cross Stick
D2	38	SIM Snare
D#2	39	808 Claps
E2	40	909 Snare
F#2	41	SIM Tom Low 2
F#2	42	Closed Hi-Hat 1 [EXC1]
G2	43	SIM Tom Low 1
G#2	44	Closed Hi-Hat [EXC1]
A2	45	SIM Tom Mid 2
A#2	46	Open Hi-Hat 1 [EXC1]
B2	47	SIM Tom Mid 1
C3	48	SIM Tom High 2
G#3	49	Crash Cymbal 1
D3	50	SIM Tom High 1
D#3	51	Ride Cymbal 1
E3	52	Pink Noise Fx
F3	53	Ride Bell 1
F#3	54	Tambourine
G3	55	Noise Fx Mute 1
G#3	56	Cowbell T
A3	57	White Noise Fx 1
A#3	58	Vibra-Slap
B3	59	White Noise Fx 2
C4	60	Conga Mute High
C#4	61	Conga Mute Low
D4	62	Conga Slap
D#4	63	Conga High
E4	64	Conga Low
F4	65	SRT Elec Tom 1
F#4	66	SRT Elec Tom 2
G4	67	Agogo High
G#4	68	Agogo Low
A4	69	Cabasa
A#4	70	Maracas
B4	71	Noise Fx Mute 2 [EXC2]
C5	72	Noise Fx [EXC2]
C#5	73	ZZZ loop Mute [EXC3]
D5	74	ZZZ loop [EXC3]
D#5	75	808 Claves
E5	76	CR78 Bongo High
F5	77	CR78 Bongo Low
F#5	78	X-modulation 1 [EXC4]
G5	79	X-modulation 2 [EXC4]
G#5	80	Ride Bell Mute [EXC5]
A5	81	Ride Bell 2 [EXC5]
A#5	82	REV Steam Drum [EXC1]
B5	83	REV 909 Kick
C6	84	909 Kick
C#6	85	808 Snare 1
D6	86	808 Snare 2
D#6	87	CR78 Open HH
E6	88	Piccolo Snare
F6	89	Synth Drum 1
F#6	90	CR78 Tambourine
G6	91	Synth Drum 2
G#6	92	808 Cowbell
A6	93	Synth Drum 3
A#6	94	X-modulation 3
B6	95	Synth Drum 4
C7	96	Synth Drum 5

音色一覧表 / Tone List

<PC No.3: d 3 Electric 2>

Key	Note No.	Rhythm Tone Name
C2	36	Round Kick
C#2	37	Cross Stick
D2	38	Piccolo Snare
D#2	39	808 Claps
E2	40	SIM Snare
F2	41	SRT Tom Low 2
F#2	42	Closed Hi-Hat 1 [EXC1]
G2	43	SRT Tom Low 1
G#2	44	Closed Hi-Hat 2 [EXC1]
A2	45	SRT Tom Mid 2
A#2	46	Open Hi-Hat [EXC1]
B2	47	SRT Tom Mid 1
C3	48	SRT Tom High 2
C#3	49	Crash Cymbal 1
D3	50	SRT Tom High 1
D#3	51	Ride Cymbal 1
E3	52	Crash Cymbal 2
F3	53	Ride Bell 1
F#3	54	Tambourine
G3	55	CR78 Open HH
G#3	56	Cowbell 1
A3	57	Crash Cymbal 3
A#3	58	Vibra-Slap
B3	59	Ride Cymbal 2
C4	60	Conga Mute High
C#4	61	Conga Mute Low
D4	62	808 Conga High
D#4	63	808 Conga Mid
E4	64	808 Conga Low
F4	65	SIM Elec Tom 1
F#4	66	SIM Elec Tom 2
G4	67	Metal X-mod 1
G#4	68	Metal X-mod 2
A4	69	Cabasa Up [EXC2]
A#4	70	Maracas
B4	71	Cabasa Down [EXC2]
C5	72	Cabasa Cut [EXC2]
C#5	73	REV X-StickMute
D5	74	REV X-Stick
D#5	75	CR78 Claves
E5	76	CR78 Bongo High
F5	77	CR78 Bongo Low
F#5	78	REV Blip
G5	79	REV Thump
G#5	80	CR78 Triangle
A5	81	CR78 Tambourine
A#5	82	REV Conga Low
B5	83	REV Conga High
C6	84	REV 808 Claps
C#6	85	REV Elec Tom
D6	86	REV 808 Open HH
D#6	87	White Hz Snare
E6	88	REV Cowbell
F6	89	REV 808 Snare
F#6	90	REV CrashCymbal
G6	91	REV 808 CHH
G#6	92	REV Elec Kick
A6	93	Steam Drum
A#6	94	Ascend Syn Drum
B6	95	Metal X-mod 3
C7	96	Sweep Syn Drum

<PC No.4: d 4 TR-808>

Key	Note No.	Rhythm Tone Name
C2	36	808 Kick
C#2	37	808 Rim Shot
D2	38	808 Snare
D#2	39	808 Claps 1
E2	40	909 Snare 1
F2	41	808 Tom Low 2
F#2	42	808 Closed HH [EXC1]
G2	43	808 Tom Low 1
G#2	44	CR78 Closed HH [EXC1]
A2	45	808 Tom Mid 2
A#2	46	808 Open HH 1 [EXC1]
B2	47	808 Tom Mid 1
C3	48	808 Tom High 2
C#3	49	CR78 Open HH
D3	50	808 Tom High 1
D#3	51	808 Open HH 2
E3	52	Crash Cymbal 1
F3	53	Ride Bell 1
F#3	54	Tambourine
G3	55	White Noiz Mute
G#3	56	808 Cowbell
A3	57	White Noise Fx
A#3	58	Vibra-Slap
B3	59	Crash Cymbal 2
C4	60	Conga Mute High
C#4	61	Conga Mute Low
D4	62	808 Conga High
D#4	63	808 Conga Mid
E4	64	808 Conga Low
F4	65	CR78 Snare 1
F#4	66	CR78 Snare 2
G4	67	CR78 Metal HH 1
G#4	68	CR78 Metal HH 2
A4	69	Cabasa Up [EXC2]
A#4	70	808 Maracas
B4	71	Cabasa Down [EXC2]
C5	72	Cabasa Cut [EXC2]
C#5	73	ZZZ loop Mute [EXC3]
D5	74	ZZZ loop [EXC3]
D#5	75	808 Claves
E5	76	CR78 Bongo High
F5	77	CR78 Bongo Low
F#5	78	X-modulation 1 [EXC4]
G5	79	X-modulation 2 [EXC4]
G#5	80	CR78 Triangle 1 [EXC5]
A5	81	CR78 Triangle 2 [EXC5]
A#5	82	REV Steam Drum [EXC1]
B5	83	REV 909 Kick
C6	84	909 Kick
C#6	85	Round Kick
D6	86	909 Snare 2
D#6	87	808 Claps 2
E6	88	REV 90's Snare
F6	89	REV Snare 1
F#6	90	REV Open Hi-Hat
G6	91	REV SIM Snare
G#6	92	REV Closed HH
A6	93	REV 808 Tom
A#6	94	REV Ride Cymbal
B6	95	REV Elec Tom
C7	96	REV Snare 2

<PC No.5: d 5 CR-78>

Key	Note No.	Rhythm Tone Name
C2	36	CR78 Kick
C#2	37	CR78 Rim Shot
D2	38	CR78 Snare
D#2	39	808 Claps
E2	40	808 Snare
F2	41	808 Tom Low 2
F#2	42	CR78 Closed HH [EXC1]
G2	43	808 Tom Low 1
G#2	44	CR78 Metal HH [EXC1]
A2	45	808 Tom Mid 2
A#2	46	CR78 Open HH 1 [EXC1]
B2	47	808 Tom Mid 1
C3	48	808 Tom High 2
C#3	49	CR78 Open HH 2
D3	50	808 Tom High 1
D#3	51	CR78 Open HH 3
E3	52	Crash Cymbal 1
F3	53	CR78 Open HH 4
F#3	54	CR78 Tambourine
G3	55	Crash Mute
G#3	56	CR78 Cowbell
A3	57	Crash Cymbal 2
A#3	58	Vibra-Slap
B3	59	Crash Cymbal 3
C4	60	808 Conga High
C#4	61	808 Conga Low
D4	62	CR78 Bongo High
D#4	63	CR78 Bongo Mid
E4	64	CR78 Bongo Low
F4	65	SIM Elec Tom 1
F#4	66	SIM Elec Tom 2
G4	67	CR78 Metal HH 1
G#4	68	CR78 Metal HH 2
A4	69	Cabasa Up [EXC2]
A#4	70	808 Maracas
B4	71	Cabasa Down [EXC2]
C5	72	Cabasa Cut [EXC2]
C#5	73	ZZZ loop Mute [EXC3]
D5	74	ZZZ loop [EXC3]
D#5	75	CR78 Claves
E5	76	Conga Mute High
F5	77	Conga Mute Low
F#5	78	X-modulation 1 [EXC4]
G5	79	X-modulation 2 [EXC4]
G#5	80	Tambourine 1 [EXC5]
A5	81	Tambourine 2 [EXC5]
A#5	82	REV Steam Drum [EXC1]
B5	83	REV 909 Kick
C6	84	MG Attack
C#6	85	REV Elec Kick
D6	86	MG Thump
D#6	87	REV Verb Kick
E6	88	REV 909 Snare
F6	89	Sweep Fx 1
F#6	90	REV 808 Kick
G6	91	White Hz Snare
G#6	92	Sweep Fx 2
A6	93	808 Conga
A#6	94	REV Cup
B6	95	REV PowerTom Hi
C7	96	REV Blip

<PC No.6: d 6 The Code>

Key	Note No.	Rhythm Tone Name
C2	36	Verb Kick 1
C#2	37	Piccolo Snare 1
D2	38	909 Snare
D#2	39	808 Claps
E2	40	Piccolo Snare 2
F2	41	SIM Tom Low 2
F#2	42	808 Closed HH 1 [EXC1]
G2	43	SIM Tom Low 1
G#2	44	808 Closed HH 2 [EXC1]
A2	45	SIM Tom Mid 2
A#2	46	808 Open Hi-Hat [EXC1]
B2	47	SIM Tom Mid 1
C3	48	SIM Tom High 2
C#3	49	Crash Cymbal 1
D3	50	SIM Tom High 1
D#3	51	Ride Cymbal 1
E3	52	Crash Cymbal 2
F3	53	Ride Bell 1
F#3	54	Tambourine
G3	55	Crash Mute
G#3	56	Cowbell 1
A3	57	Crash Cymbal 3
A#3	58	Cowbell 2
B3	59	Ride Cymbal 2
C4	60	Atmosphere
C#4	61	Conga Mute High
D4	62	Conga Slap
D#4	63	Conga Mute Low
E4	64	Conga Low
F4	65	Rim Shot
F#4	66	Crash Cymbal 4
G4	67	MG White Noise
G#4	68	Cabasa Down
A4	69	CR78 Open HH
A#4	70	Cabasa Up
B4	71	Noise Loop
C5	72	Verb Kick 2
C#5	73	808 Claves
D5	74	90's Snare 1
D#5	75	CR78 Claves
E5	76	90's Snare 2
F5	77	SRT Elec Tom 1
F#5	78	Closed Hi-Hat 1 [EXC2]
G5	79	SRT Elec Tom 2
G#5	80	Closed Hi-Hat 2 [EXC2]
A5	81	SRT Elec Tom 3
A#5	82	808 Open Hi-Hat [EXC2]
B5	83	SRT Elec Tom 4
C6	84	SRT Elec Tom 5
C#6	85	Noise Fx 1
D6	86	CR78 Snare
D#6	87	CR78 Open HH
E6	88	808 Snare
F6	89	CR78 Bongo Low
F#6	90	Noise Fx 2
G6	91	CR78 Bongo High
G#6	92	808 Cowbell
A6	93	808 Conga Low
A#6	94	CR78 Cowbell
B6	95	808 Conga High
C7	96	REV Blip

ウェーブフォーム一覧表
Waveform List

<PC No.7: d 7 Eyes>

Key	Note No.	Rhythm Tone Name
C2	36	Verb Kick
G#2	37	Cross Stick
D2	38	CR78 Snare
D#2	39	808 Claps
E2	40	Piccola Snare
F2	41	SIM Tom Low 2
F#2	42	Closed Hi-Hat 1 [EXC1]
G2	43	SIM Tom Low 1
G#2	44	Closed Hi-Hat 2 [EXC1]
A2	45	SIM Tom Mid 2
A#2	46	Open Hi-Hat 1 [EXC1]
B2	47	SIM Tom Mid 1
C3	48	SIM Tom High 2
C#3	49	Crash Cymbal 1
D3	50	SIM Tom High 1
D#3	51	Ride Cymbal 1
E3	52	Crash Cymbal 2
F3	53	Ride Bell 1
F#3	54	Tambourine
G3	55	Crash Mute
G#3	56	Cowbell 1
A3	57	Crash Cymbal 3
A#3	58	Cowbell 2
B3	59	Crash Cymbal 4
C4	60	Conga Mute Hi 1
C#4	61	Conga Mute Low
D4	62	Conga Slap
D#4	63	Conga Mute Hi 2
E4	64	Conga Low
F4	65	Rim Shot 1
F#4	66	Rim Shot 2
G4	67	808 Maracas
G#4	68	Cabasa Down
A4	69	Maracas
A#4	70	Cabasa Up
B4	71	909 Kick
C5	72	808 Kick
C#5	73	808 Claves
D5	74	808 Snare
D#5	75	CR78 Claves
E5	76	909 Snare
F5	77	808 Tom 1
F#5	78	808 Closed HH
G5	79	SIM Elec Tom 1
G#5	80	CR78 Closed HH
A5	81	808 Tom 2
A#5	82	808 Open Hat [EXC1]
B5	83	SIM Elec Tom 2
C6	84	808 Tom 3
C#6	85	Noise Fx 1
D6	86	SIM Elec Tom 3
D#6	87	CR78 Open HH
E6	88	Noise Fx 2
F6	89	CR78 Bongo Low
F#6	90	CR78 Tambourine
G6	91	CR78 Bongo High
G#6	92	808 Cowbell
A6	93	808 Conga Low
A#6	94	CR78 Cowbell
B6	95	808 Conga High
C7	96	REV Blip

<PC No.8: d 8 The Tardis>

Key	Note No.	Rhythm Tone Name
C2	36	Round Kick
G#2	37	808 Rim Shot
D2	38	909 Snare
D#2	39	808 Claps
E2	40	808 Snare
F2	41	808 Tom Low
F#2	42	CR78 Closed HH [EXC1]
G2	43	SIM Tom Low
G#2	44	CR78 Metal HH [EXC1]
A2	45	808 Tom Mid
A#2	46	CR78 Open Hat [EXC1]
B2	47	SIM Tom Mid
C3	48	808 Tom High
C#3	49	Crash Cymbal
D3	50	SIM Tom High
D#3	51	Ride Cymbal
E3	52	Ride Bell
F3	53	CR78 Tambourine
F#3	54	808 Closed HH [EXC2]
G3	55	Closed Hi-Hat 1 [EXC3]
G#3	56	808 Cowbell
A3	57	Closed Hi-Hat 2 [EXC3]
A#3	58	808 Open Hi-Hat [EXC2]
B3	59	Open Hi-Hat 1 [EXC3]
C4	60	Conga Mute High
C#4	61	Conga High
D4	62	Conga Slop
D#4	63	Conga Low
E4	64	Conga Mute Low
F4	65	808 Conga High
F#4	66	808 Conga Low
G4	67	CR78 Bongo High
G#4	68	CR78 Bongo Low
A4	69	CR78 Cowbell
A#4	70	Noise Fx 1
B4	71	Cabasa Up
C5	72	Cabasa Down
C#5	73	808 Maracas
D5	74	Cabasa Cut
D#5	75	Tambourine
E5	76	CR78 Rim Shot
F5	77	808 Claves
F#5	78	CR78 Triangle 1 [EXC4]
G5	79	CR78 Triangle 2 [EXC4]
G#5	80	REV Thump
A5	81	Verb Kick
A#5	82	CR78 Kick
B5	83	909 Kick
C6	84	808 Kick
C#6	85	Electric Kick
D6	86	CR78 Snare
D#6	87	SIM Snare
E6	88	90's Snare
F6	89	Power Tom 1
F#6	90	REV Elec Tom
G6	91	Atmosphere Mute
G#6	92	SRT Elec Tom 1
A6	93	Power Tom 2
A#6	94	SRT Elec Tom 2
B6	95	Noise Fx 2
C7	96	Power Tom 2

No.	Wave Name	No.	Wave Name	No.	Wave Name	No.	Wave Name
1	JP-8 Saw A	65	OBXP Str A	129	MKS-80 Xmod1	193	808_OHH
2	JP-8 Saw C	66	OBXP Str B	130	MKS-80 Xmod2	194	C78_MHH
3	JX-10 Saw	67	OBXP Str C	131	MKS-80 Xmod3	195	C78_CHH
4	SH-5 Saw	68	OBXP Str Lp	132	MKS-80 Xmod4	196	C78_OHH
5	SH-2 Saw	69	MG Oct A	133	OB Bass	197	Crash 1
6	SH-101 Saw	70	MG Oct B	134	OB Bass Lp C	198	Ride 1
7	SH-10 Saw	71	MG Dt.Oct A	135	MG BsPedal	199	Ride Bell 1
8	GR-3 Saw 1	72	MG Dt.Oct C	136	MG BsPdLpA	200	Power Tom Hi
9	GR-3 Saw 2	73	OBXP Brass A	137	MG BsPdLpC	201	808_TM3
10	JU-2 Saw	74	OBXP Brass C	138	MG Fat Bs	202	E_DR Tom 1
11	MG Saw 1A	75	OBXP BrassLp	139	MG Sharp Bs1	203	E_DR Tom 2
12	MG Saw 2	76	FM Brass	140	MG Big Bs	204	Cross Stick1
13	P5 Saw 1A	77	Wasp	141	MG ClassicBs	205	808_CLV
14	P5 Saw 1C	78	Wasp Lp	142	MG Sharp Bs2	206	C78_CLV
15	26 Saw	79	OB Lead	143	TB-303 Bass	207	808 Claps
16	AP Saw	80	OB Lead Lp	144	JP-4 Bass 1	208	Cowbell 1
17	OSC Reso Saw	81	JP-6 SqLead	145	JP-4 Bass 2	209	808_CWBL
18	KG7 Saw	82	JP-6 SqLd Lp	146	SH-101 Bs 1	210	C78_CWBL
19	KG8 Saw 1	83	Blown 2	147	SH-101 Bs 2	211	Tambourine
20	CS Saw 1A	84	PG Sweep 1A	148	SH-101 Bs 3	212	C78_TMB
21	CS Saw 1C	85	PG Sweep 1C	149	SH-101 Bs 4	213	C78_TR1
22	CS Saw 2	86	PG Sweep 2A	150	Sys7 Bs 1	214	C78_LBGO
23	JP-8 SquareA	87	PG Sweep 2C	151	Sys7 Bs 2	215	CGA Mute Hi
24	JX-10 Square	88	D-50 HeavenA	152	FM Super Bs	216	CGA Mute Lo
25	SH-5 Square	89	D-50 HeavenB	153	KG Poly Bs	217	CGA Slap
26	MG Square A	90	D-50 HeavenC	154	Power B sWvA	218	Conga Hi
27	26 Square	91	JX-8P Vox	155	Power B sWvC	219	Conga Lo
28	KG MS Square	92	JX-8P Vox Lp	156	Power B fStA	220	808_CNG1
29	CS Square	93	VP-330ChoirA	157	Power B fStB	221	Maracas
30	JP-8 Pulse 1	94	VP-330ChoirB	158	Power B fStC	222	808_MRC
31	JP-8 Pulse 2	95	VP-330ChoirC	159	Tron Choir A	223	Cabasa Cut
32	JP-8 Pulse 3	96	P5 Unisync	160	Tron Choir C	224	Cabasa Up
33	JP-8 Pulse 4	97	P5 UnisyncLp	161	Tron Flute A	225	Cabasa Down
34	SH-10 Puls	98	P5 Diphthong	162	Tron Flute C	226	REV SteamDrum
35	MG Pulse 1A	99	P5 DiphthongLp	163	Tron Str A	227	REV Blip
36	MG Pulse 1C	100	FM Lead	164	Tron Str B	228	REV Thump
37	MG Pulse 2A	101	KG8 Lead	165	Tron Str C	229	REV 808_SNR1
38	MG Pulse 2C	102	MG Lead	166	MG White Nz	230	REV 90_Snare
39	26 Pulse 1	103	MG Lead Lp	167	SH-5 Pink Nz	231	REV SN 1
40	CS Pulse 2	104	JP-8 Lead	168	JP-8 X-mod 1	232	REV SN 4
41	JU-2 Sub OSC	105	Digiwave 1	169	JP-8 X-mod 2	233	REV 909_SN1
42	MG Ramp	106	Digiwave 3	170	P5 Noise 1	234	REV SIM_SN1
43	26Triangle	107	SRG FM	171	P5 Noise 2	235	REV VerbKick
44	26 Sine	108	Shimmer wave	172	ZZZ loop	236	REV 808 Kick
45	JP-8 PWM A	109	VS Organ A	173	Atmosphere	237	REV 909_K1
46	JP-8 PWM B	110	VS Organ C	174	808_SNR 1	238	REV E_DRKick
47	JP-8 PWM C	111	Juno Organ	175	90's Snare	239	REV Cl.HAT 1
48	MG Dt.Saw A	112	Juno OrganLp	176	Piccola SN	240	REV OpenHAT1
49	MG Dt.Saw B	113	FM Punch	177	Rim Shot	241	REV 808_CHH
50	MG Dt.Saw C	114	Mondigital	178	808_RIM	242	REV 808_OHH
51	P5 Dt.Saw A	115	MondigitalLp	179	909_SN1	243	REV Crash 1
52	P5 Dt.Saw B	116	JP-8 Clavi A	180	C78_SD	244	REV Ride 1
53	P5 Dt.Saw C	117	JP-8 Clavi C	181	C78_RIM	245	REV Cup
54	MG Dt.Squ A	118	JP-8 ClaviLp	182	SIM_SN1	246	REV PwTom Hi
55	MG Dt.Squ B	119	Juno Clavi	183	Verb Kick	247	REV 808_TM3
56	MG Dt.Squ C	120	P5 X-mod	184	Round Kick	248	REV E Tom 1
57	JP-8 Str A	121	Steam Drum	185	808 Kick	249	REV E Tom 2
58	JP-8 Str B	122	Kalimba Aik	186	909 Kick	250	REV X Stick 1
59	JP-8 Str C	123	Additive	187	C78_BD	251	REV 808 Clps
60	OB Str 2A	124	MG Blip	188	E_DR Kick	252	REV Cowbell1
61	OB Str 2B	125	MG Thump	189	Closed HAT 1	253	REV Congo
62	OB Str 2C	126	MG Attack	190	Closed HAT 2	254	REV Congo Hi
63	AP Str Ens A	127	VS Bell 1	191	Open HAT 1		
64	AP Str Ens B	128	JP-6 Bell	192	808_CHH		

音色一覧表 / Tone List

音色一覧表について

■パフォーマンス一覧表について

パフォーマンスP01～P02は、往年のビンテージ・シンセサイザーの中から代表的なサウンドを中心に集めたものです。

パフォーマンスP03～P09は、それぞれの音楽ジャンルに適したシンセ・サウンドを集めたパフォーマンスです。

パフォーマンスP10～P12は、本体に内蔵されているデモ曲で使用しています。

パフォーマンスP13～P15は、エフェクターの特長を活かしたソロ演奏用のパフォーマンスです。Pan-Delayではディレイ音が左右に飛び交い、Flangerでは独特のうねり感が得られます。

パフォーマンスP16は、複数のパッチを重ねてより厚い音色で演奏できるようにしたパフォーマンスです（Part 1～5の受信チャンネルは1に設定、Part 6～8はMuteされています）。

パフォーマンスP17は、すべてのパートが最も標準的な値に設定されています。GMシステム・オン、GSリセットを受信したときはこのパフォーマンスが呼び出されます。パート・パラメーターの初期設定は以下のようになっています。

Part Param1	Part Param2	MIDI Rx
Level = 100	Rx Ch = 1-7,10	Vol&Hold = ON
Pan = 0	Key Shift = 0	Prog Chg = ON
Reverb = 64	Detune = 0	-----
Chorus = 64	Assign = 0	-----

●外部MIDI機器からのパフォーマンスの切り替えかた
MIDIメッセージを使って外部機器からパフォーマンスを切り替えたいときは、以下の手順で本機に各MIDIメッセージを送信してください。

1. システム・エクスクルーシブ・メッセージを送信して、コントローラー・チャンネル（パフォーマンス切り替えに使うMIDIチャンネル）を設定する（工場出荷時はOFFに設定されています）。
（例）コントロール・チャンネルを16に設定する
F0 41 10 46 12 00 00 00 20 0F 51 F7
2. コントローラー・ナンバー0の値を、本機の「バンク・セレクト・メッセージ受信スイッチ」で設定した値に合わせて送信する。その後、コントローラー・ナンバー32の値として0を送信する。
3. プログラム・ナンバー1～17を送信する。

■パッチ一覧表について

コントローラー・ナンバー0の値は工場出荷時のものです。本機のバンク・セレクト・メッセージ受信スイッチの設定（サウンド・エクスパンション・シリーズ取扱説明書p.5参照）を変更している場合は、その値を参照してください。

■音色テーブル2について

M-VS1にはGM/GS音源用のSMFミュージック・データを利用する際に便利な「音色テーブル2」という音色配列があります。MIDI INからGMシステム・オン、またはGSリセットを受信すると音色テーブル2に切り替わり、パフォーマンスNo.17 (Default Perf) が呼び出されます。

音色テーブル2に切り替えると、本機のバンク・セレクト・メッセージ受信スイッチの設定（サウンド・エクスパンション・シリーズ取扱説明書p.5参照）が無効になり、表のプログラム・ナンバー、コントローラー・ナンバー0の値、コントローラー・ナンバー32の値にしたがってパッチ、リズム・セットが切り替わります。

上記以外の値を受信するとディスプレイに「noP.」と表示されそのパートは発音しません。ただし、パネルの操作ではすべてのパッチ、リズム・セットを選ぶことができます。

■リズム・セット一覧表について

コントローラー・ナンバー0の値は工場出荷時のものです。本機のバンク・セレクト・メッセージ受信スイッチの設定（サウンド・エクスパンション・シリーズ取扱説明書p.5参照）を変更している場合は、その値を使用してください。

[EXC]が同じ番号になっている打楽器音は同時に鳴りません。

■ウェーブフォーム一覧表について

M-VS1では表に挙げるさまざまなウェーブフォームを用いてパッチやリズム・セットを作成しています。パッチやリズム・セットを構成するウェーブフォームを、パネル操作で変更することはできませんが、システム・エクスクルーシブ・メッセージを使うと変えることができます。その際に、本表をご利用ください。

<注意>

※プログラム・チェンジで実際に送受信されるデータは、PC No.から1を引いた値になりますのでご注意ください。

※本機ではエフェクトのかかり具合が各パッチに対して最適になるようにあらかじめ設定しています。したがってリバーブ/コーラス・センド・レベルの効き具合は各パッチで異なります。

※パフォーマンス・モードで、パッチで設定されているエフェクトのセンド・レベルをそのまま有効にしたいときは、パートのセンド・レベルを64にしてください。64以外にするとパッチのセンド・レベルの値も相対的に増減します。

About the Tone List

■ About the Performance List

Performances P01 and P02 contain representative sounds from vintage synthesizers.

Synthesizer sounds geared for specific styles of music are located at Performances P03 through P09.

The demo songs the unit provides are located in Performances P10 through P12.

In Performances P13 through P15 you will find a selection of Performances that are ideal for use with solo pieces, and which make the best use of the effects'. Pan-Delay causes delayed sound to be panned left and right, while Flanger provides a unique kind of undulation.

Performance P16 combines multiple Patches to provide a truly fat sound. (Parts 1-5 are set to receive on channel 1, while Parts 6-8 are set to "Mute.")

Performance P17 could be thought of as the standard Performance, since each Part is set to the most neutral values. This Performance is the one that is called up whenever a General MIDI System On or GS Reset is received. The initial values for the Part Parameters are shown below.

Part Param1	Part Param2	MIDI Rx
Level = 100	Rx Ch = 1-7,10	Vol&Hold = ON
Pan = 0	Key Shift = 0	Prog Chg = ON
Reverb = 64	Detune = 0	-----
Chorus = 64	Assign = 0	-----

• How to Switch Performances from an External Instrument

If you want to connect an external instrument to switch Performances using MIDI messages, you need to carry out the following steps to send the required MIDI messages to the M-VS1.

1. Send System Exclusive (SysEx) messages to set the control channel (the MIDI channel used for changing Performances). At the factory defaults, this parameter is set to OFF.
Example:
To set the control channel to "16," send:
F0 41 10 46 12 00 00 00 20 0F 51 F7
2. Send a value for Controller Number 0 that matches the value set for Bank Select Message Reception on the M-VS1. Then send "0" as the value for Controller Number 32.
3. Send the Program Number (PC #1 through #17).

■ About the Patch List

The Controller No. 0 (CC0) value shown in the lists is the value when at the factory defaults. If you have altered the setting for "Bank Sel" (Bank Select Message Reception; see page 5 in the Sound Expansion Series manual), remember to take the current value into account.

■ Tone Table 2.....

The M-VS1 offers a tone layout called Tone Table 2 that comes in handy when using a GM score or music data for a GS sound module.

When a General MIDI System On message or GS Reset message is received from the MIDI IN connector, the M-VS1 switches to Tone Table 2 and calls up Performance Number 17.

When switched to Tone Table 2, the setting for Bank Select Message Reception on the M-VS1 (see page 5 of the Sound Expansion Series Owner's Manual) is disabled, and Patches are switched according to the Program Number listed above and the values for Controller Number 0 and Controller Number 32.

If a value other than those in the list is received, the message "noP." appears on the display and that Part is not played. However, you can use the panel to choose any Patch or Rhythm Set.

■ About the Rhythm Set List

The Controller No. 0 (CC0) value shown in the lists is the value when at the factory defaults. If you have altered the setting for "Bank Sel" (Bank Select Message Reception; see page 5 in the Sound Expansion Series manual), remember to take the current value into account.

[EXC]: Percussion sounds with the same number are not played at the same time.

■ About the Waveform List

The Patches and Rhythm Sets provided by the M-VS1 were all created using the Waveforms shown in the lists. Although the way the Waveforms are assigned to Patches cannot be altered from the panel, you can change these assignments using System Exclusive messages. The lists should be referred to carefully whenever you wish to carry out such changes.

Notes

- * Please be aware that the Program Change data that is actually sent or received is one less than the value of the PC number described above.
- * The extent to which the Reverb/Chorus Send Level will act in modifying the sound will be different depending on the Patch. This is because the effects have been set differently for each Patch, in order to produce the best possible sound.
- * The Send Level for Parts should be set to "64" if you want the Send Level for the effects that are specified to be used by the Patches to be applied in the originally intended way. At any value other than "64," the value of the Patch Send Level will increase/decrease in a relative manner with respect to it.

主な仕様

サウンド・エクспанション・シリーズ M-VS1
: マルチティンバー・サウンド・モジュール

- パート
パート 1~7、リズム・パート
- 最大同時発音数
28音
- エフェクト
リバーブ (8種類)
コーラス (3種類)
- メモリー
システム・セットアップ: 1
パフォーマンス: 17
パッチ: 255
リズム・セット: 8
- 接続端子
MIDI 端子 (イン、アウト、スルー)
インプット・ジャック (L, R)
アウトプット・ジャック (L, R)
ヘッドホン・ジャック (ステレオ)
- ディスプレイ
7セグメント3桁 (LED)
- 電源
AC100V
- 消費電力
7 W
- 外形寸法
482 (幅) × 165 (奥行) × 44 (高さ) mm
(EIA-1Uラック・マウント・タイプ)
- 重量
2.65kg
- 付属品
サウンド・エクспанション・シリーズ取扱説明書
M-VS1 取扱説明書
AC電源コード
- 別売品
ステレオ・ヘッドホン: RH-20/80/120
システム・ラック: SYRシリーズ

※本機の仕様および外観は、改良のため予告無く変更することがあります。

Specifications

Sound Expansion Series M-VS1
: Multi-timbral Sound Module

- Parts
Parts 1 — 7, Rhythm Part
- Maximum Polyphony
28 Voices
- Effects
Reverb (8 types)
Chorus (3 types)
- Internal Memory
System Setups: 1
Performances: 17
Patches: 255
Rhythm Sets: 8
- Connectors
MIDI Connectors (In, Out, Thru)
Input Jacks (L, R)
Output Jacks (L, R)
Phones Jack (Stereo)
- Display
7 Segments, 3 Characters (LED)
- Power Supply
AC 117 V, AC 230 V or AC 240 V
- Power Consumption
10 W (AC 117 V, AC 230 V) or 11 W (AC 240 V)
- Dimensions
482 (W) x 165 (D) x 44 (H) mm
19 (W) x 6-1/2 (D) x 1-3/4 (H) inches
(EIA-1U Rack Mount Type)
- Weight
2.65 kg
5 lbs, 14 oz
- Accessories
Sound Expansion Series Owner's Manual
M-VS1 Owner's Manual
AC Cord

* In the interest of product development, the specifications and/or appearance of this unit are subject to change without prior notice.

サービスの窓口

商品と修理に関するお問い合わせは 最寄りの営業所までご相談ください。

札幌営業所

〒060 札幌市中央区大通西6-2-6
三井生命札幌大通ビル7F TEL (011) 281-0708

仙台営業所

〒980 仙台市青葉区本町2-10-33
第2日本オフィスビル1F TEL (022) 225-6221

大宮営業所

〒331 大宮市桜木町1-441
GINZA YAMATO3 6F TEL (048) 648-8977

東京営業所

〒101 東京都千代田区神田須田町2-7
タームスビル7F TEL 代表(03) 3251-5595

横浜営業所

〒221 横浜市神奈川区鶴屋町2-11-3
KMビル5F TEL (045) 313-3841

名古屋営業所

〒460 名古屋市中区栄2-11-7
伏見大島ビル2F TEL (052) 202-1881

大阪営業所

〒530 大阪市北区堂島浜1-4-16
大和堂島ビル5F TEL代表 (06) 345-9521

広島営業所

〒730 広島市中区紙屋町1-1-17
広島MIDビル4F TEL (082) 247-2731

福岡営業所

〒812 福岡市博多区店屋町1-31
東京生命福岡ビル7F TEL (092) 282-4190

修理に関するお問い合わせは . . . 商品をお求めの販売店か上記営業所、または下記のサービス・ステーション
あるいはサービス・スポットまでご相談ください。 なお、保証期間内の場合は保証書を添えてご依頼ください。

東京サービス・ステーション

〒101 東京都千代田区神田須田町2-7
タームスビル7F TEL (03) 3251-1391

浜松サービス・ステーション

〒433 浜松市高丘町1006-14
TEL (053) 437-3212

大阪サービス・ステーション

〒559 大阪市住之江区新北島3-8-53
TEL (06) 681-5321

福岡サービス・ステーション

〒812 福岡市博多区店屋町1-31
東京生命福岡ビル7F TEL (092) 282-4190

函館サービス・スポット〈(有)ドルビィ〉

〒042 函館市柏木町35-25 TEL (0138) 53-6249

秋田サービス・スポット〈(有)音響サービス〉

〒010 秋田市南通亀の町12-16
TEL (0188) 33-3465

新潟サービス・スポット〈サウンド・リペア北越〉

〒940 長岡市荻野1-7-16 TEL (0258) 29-2732

金沢サービス・スポット〈オリバー電子(有)〉

〒921 金沢市額谷1-32 TEL (0762) 98-8309

姫路サービス・スポット〈ギター ワークショップ PEG〉

〒670 姫路市総社本町214 TEL (0792) 82-6529

商品のお取り扱いに関するお問い合わせは . . . お客様相談センターまでご相談ください。

お客様相談センター 受付時間：午前10時～午後5時（土、日曜、祝日を除く）

■東京 TEL (03) 3251-6150

〒101 東京都千代田区神田須田町2-7 タームスビル7F

■大阪 TEL (06) 345-9500

〒530 大阪市北区堂島浜1-4-16 大和堂島ビル5F

*上記窓口の名称、所在地、電話番号等は、予告なく変更することがありますのでご了承ください。

Apparatus containing Lithium batteries

ADVARSEL!

Lithiumbatteri - Eksplosionsfare ved fejlagtig håndtering. Udskitning må kun ske med batteri af samme fabrikat og type. Levér det brugte batteri tilbage til leverandøren.

VARNING!

Explosionsfara vid felaktigt batteribyte. Använd samma batterityp eller en ekvivalent typ som rekommenderas av apparattillverkaren. Kassera använt batteri enligt fabrikantens instruktion.

ADVARSEL!

Lithiumbatteri - Eksplosjonsfare. Ved utskifting benyttes kun batteri som anbefalt av apparatfabrikanten. Brukt batteri returneres apparatleverandøren.

VAROITUS!

Paristo voi räjähtää, jos se on virheellisesti asennettu. Vaihda paristo ainoastaan laitevalmistajan suosittelemaan tyyppiin. Hävitä käytetty paristo valmistajan ohjeiden mukaisesti.

Bescheinigung des Herstellers/Importeurs

Hiermit wird bescheinigt, daß der/die/das
M-VS1 SOUND MODULE

(Gerät, Typ, Bezeichnung)

in Übereinstimmung mit den Bestimmungen der BMPT-AmtsblVfg 243/1991 funk-entstört ist. Der vorschriftsmäßige Betrieb mancher Geräte (z. B. Meßsender) kann allerdings gewissen Einschränkungen unterliegen. Beachten Sie deshalb die Hinweise in der Bedienungsanleitung.

Dem Zentralamt für Zulassungen im Fernmeldewesen wurde das Inverkehrbringen dieses Gerätes angezeigt und die Berechtigung zur Überprüfung der Serie auf die Einhaltung der Bestimmungen eingeräumt.

Roland Corporation

4-16 Dojimahama 1-Chome Kita-ku Osaka 530 Japan

(Name und Anschrift des Herstellers/Importeurs)

FEDERAL COMMUNICATIONS COMMISSION RADIO FREQUENCY INTERFERENCE STATEMENT

This equipment has been tested and found to comply with the limits for a Class B digital device, pursuant to Part 15 of the FCC Rules. These limits are designed to provide reasonable protection against harmful interference in a residential installation. This equipment generates, uses, and can radiate radio frequency energy and, if not installed and used in accordance with the instructions, may cause harmful interference to radio communications. However, there is no guarantee that interference will not occur in a particular installation. If this equipment does cause harmful interference to radio or television reception, which can be determined by turning the equipment off and on, the user is encouraged to try to correct the interference by one or more of the following measures:

- Reorient or relocate the receiving antenna.
- Increase the separation between the equipment and receiver.
- Connect the equipment into an outlet on a circuit different from that to which the receiver is connected.
- Consult the dealer or an experienced radio/TV technician for help.

Unauthorized changes or modification to this system can void the users authority to operate this equipment. This equipment requires shielded interface cables in order to meet FCC class B Limit.

CLASS B

NOTICE

This digital apparatus does not exceed the Class B limits for radio noise emissions set out in the Radio Interference Regulations of the Canadian Department of Communications.

CLASSE B

AVIS

Cet appareil numérique ne dépasse pas les limites de la classe B au niveau des émissions de bruits radioélectriques fixés dans le Règlement des signaux parasites par le ministère canadien des Communications.

Information

When you need repair service, call your local Roland Service Station or the authorized Roland distributor in your country as shown below.

U. S. A.

Roland Corporation U.S.
7200 Dominion Circle
Los Angeles, CA. 90040-3696, U. S. A.
TEL: (213) 685 5141

CANADA

Roland Canada Music Ltd. (Head Office)
5480 Parkwood Way
Richmond B. C., V6V 2M4
CANADA
TEL: (604) 270 6626

Roland Canada Music Ltd. (Montreal Office)
9425 Transcanadienne
Service Rd. N., St Laurent,
Quebec H4S 1V3, CANADA
TEL: (514) 335 2009

Roland Canada Music Ltd. (Toronto Office)
346 Watline Avenue,
Mississauga, Ontario L4Z
1X2, CANADA
TEL: (416) 890 6488

AUSTRALIA

Roland Corporation Australia Pty. Ltd.
38 Campbell Avenue
Dee Why West. NSW 2099
AUSTRALIA
TEL: (02) 982 8266

NEW ZEALAND

Roland Corporation (NZ) Ltd.
97 Mt. Eden Road, Mt. Eden,
Auckland 3, NEW
ZEALAND
TEL: (09) 3098 715

UNITED KINGDOM

Roland (U.K.) Ltd.
Rye Close Ancells Business
Park Fleet, Hampshire GU13
8UY, UNITED KINGDOM
TEL: (0252) 816181

Roland (U.K.) Ltd., Swansea Office

Atlantic Close, Swansea
Enterprise Park, Swansea,
West Glamorgan SA79FJ,
UNITED KINGDOM
TEL: (0792) 700 139

IRELAND

The Dublin Service Centre Audio Maintenance Limited
11 Brunswick Place Dublin 2
Republic of Ireland
TEL: (01) 677322

ITALY

Roland Italy S. p. A.
Viale delle Industrie 8 20020
ARESE MILANO ITALY
TEL: (02) 93581311

SPAIN

Roland Electronics de España, S. A.
Calle Bolivia 239 08020
Barcelona, SPAIN
TEL: (93) 308 1000

GERMANY

Roland Elektronische Musikinstrumente Handelsgesellschaft mbH.
Oststrasse 96, 22844
Norderstedt, GERMANY
TEL: (040) 52 60090

FRANCE

Guillard Musiques Roland
ZAC de Rosarge Les Echets
01700
MIRIBEL FRANCE
TEL: (72) 26 5060

Guillard Musiques Roland (Paris Office)

1923 rue Léon Geoffroy
94400 VITRY-SUR-SEINE
FRANCE
TEL: (1) 4680 86 62

BELGIUM/HOLLAND/ LUXEMBOURG

Roland Benelux N. V.
Houtstraat 1 B-2260 Oevel-
Westerlo BELGIUM
TEL: (014) 575811

DENMARK

Roland Scandinavia A/S
Langebrogade 6 Box 1937
DK-1023 Copenhagen K.
DENMARK
TEL: 31 95 31 11

SWEDEN

Roland Scandinavia A/S
Danvik Center 28 A, 2 tr.
S-131 30 Nacka SWEDEN
TEL: (08) 702 0020

NORWAY

Roland Scandinavia Avd. Kontor Norge
Lilleakerveien 2 Postboks 95
Lilleaker N-0216 Oslo 2
NORWAY
TEL: (02) 73 0074

FINLAND

Fazer Musik Inc.
Länsituulentie POB 169,
SF-02101 Espoo FINLAND
TEL: (00) 43 5011

SWITZERLAND

Roland (Switzerland) AG Musitronic AG
Gerberstrasse 5, CH-4410
Liestal, SWITZERLAND
TEL: (061) 921 1615

AUSTRIA

E. Dematte & Co.
Neu-Rum Siemens-Strasse 4
A-6040 Innsbruck P.O.Box
83
AUSTRIA
TEL: (0512) 26 44 260

GREECE

V. Dimitriadis & Co. Ltd.
20, Alexandras St. &
Bouboulinas 54 St. 106 82
Athens, GREECE
TEL: (01) 8232415

PORTUGAL

Caius - Tecnologias Audio e Musica, Lda.
Rue de Catarina 131
4000 Porto, PORTUGAL
TEL: (02) 38 4456

HUNGARY

Intermusica Ltd.
Warehouse Area 'DEPO'
Pf.83 H-2046 Torokbalint,
Budapest HUNGARY
TEL: (1) 1868905

ISRAEL

D.J.A. International Ltd.
Twin Towers, 33 Jabtinsky St.
Room 211, Ramat Gan 52511
ISRAEL
TEL: (03) 751 8585

CYPRUS

Radex Sound Equipment Ltd.
17 Diagorou St., P.O.Box
2046, Nicosia CYPRUS
TEL: (2) 453 426
(2) 466 423

U.A.E

Zak Electronics & Musical Instruments Co.
P.O. Box 8050
DUBAI, U.A.E
TEL: 360715

KUWAIT

Easa Husain Al-Yousifi
P.O. Box 126 Safat 13002
KUWAIT
TEL: 5719499

LEBANON

A. Chahine & Fils
P.O. Box 16-5857
Beirut, LEBANON
TEL: (01) 335799

TURKEY

Barkat Sanayi ve Ticaret
Siraselviler Cad. 86/6
Taksim Istanbul, TURKEY
TEL: (0212) 2499324

EGYPT

Al Fanny Trading Office
9, Ebn Hagar At Askalany
Street, Ard El Golf,
Heliopolis, Cairo, 11341
EGYPT
TEL: (02) 4171828
(02) 4185531

QATAR

Badie Studio & Stores
P.O.Box 62,
DOHA Qatar
TEL: 423554

SYRIA

Technical Light & Sound Center
Khaled Ebn Al Walid St.
P.O.Box 13520
Damascus - Syria
TEL: (11) 2235 384

BAHRAIN

Moon Stores
Bad Al Bahrain Road,
P.O.Box 20077
State of Bahrain
TEL: 211 005

REUNION

FO - YAM Marcel
25 Rue Jules MermanZL
Chaudron - BP79 97491
Ste Clotilde REUNION
TEL: 262 28 29 16

BRAZIL

Roland Brasil Ltda.
R. Coronel Octaviano da
Silveira 203 05522-010
Sao Paulo BRAZIL
TEL: (11) 843 9377

MEXICO

Casa Veerkamp, s.a. de c.v.
Mesones No. 21 Col. Centro
MEXICO D.F. 06080
TEL: (905) 709 3716

La Casa Wagner de Guadalajara s.a. de c.v.

Av. Corona No. 202 S.J.
Guadalajara, Jalisco
MEXICO C.P.44100
TEL: (36) 13 1414

VENEZUELA

Musicland Digital C.A.
Av. Francisco de Miranda,
Centro Parque de Cristal,
Nivel C2 Local 20 Caracas
VENEZUELA
TEL: (2) 285 9218

PANAMA

Productos Superiores, S.A.
Apartado 655 - Panama 1
REP. DE PANAMA
TEL: 26 3322

ARGENTINA

Instrumentos Musicales S.A.
Florida 638
(1005) Buenos Aires
ARGENTINA
TEL: (1) 394 4029

HONG KONG

Tom Lee Music Co., Ltd. Service Division
22-32 Pun Shan Street, Tsuen
Wan, New Territories,
HONG KONG
TEL: 852 2 737 7688

KOREA

Cosmos Corporation Service Station
261 2nd Floor Nak-Won
Arcade Jong-Ro ku, Seoul,
KOREA
TEL: (02) 742 8844

SINGAPORE

Swee Lee Company
BLOCK 231,
Bain Street #03-23
Bras Basah Complex,
Singapore 0718
TEL: 3367886

CRISTOFORI MUSIC PTE LTD

335, Joo Chiat Road
SINGAPORE 1542
REPUBLIC OF SINGAPORE
TEL: 3450435

PHILIPPINES

G.A. Yupango & Co. Inc.
339 Gil J. Puyat Avenue
Makati, Metro Manila 1200,
PHILIPPINES
TEL: (02) 817 0013

THAILAND

Theera Music Co., Ltd.
330 Verng Nakorn Kasem,
Soi 2, Bangkok 10100,
THAILAND
TEL: (02) 2248821

MALAYSIA

Bentley Music SDN BHD
No.142, Jalan Bukit Bintang
55100 Kuala Lumpur,
MALAYSIA
TEL: (03) 2443333

INDONESIA

PT CITRARAMA BELANTIKA
Kompleks Perkantoran Duta
Merlin Blok E No.6-7
Jl. Gajah Mada No.3-5,
Jakarta 10130,
INDONESIA
TEL: (021) 3850073

TAIWAN

Siruba Enterprise (Taiwan) Co., LTD.
Room. 5, 9fl. No. 112 Chung
Shan N.Road Sec.2 Taipei,
TAIWAN, R.O.C.
TEL: (02) 571 5860

SOUTH AFRICA

That Other Music Shop (PTY) Ltd.
11 Melle Street (Cnr Melle
and Juta Street)
Braamfontein 2001
Republic of South Africa
TEL: (011) 403 4105

Paul Bothner (PTY) Ltd.

17 Werdmuller Centre
Claremont 7700
Republic of South Africa
TEL: (021) 64 4030

As of Feb. 23, 1995

サウンド・エクステンション・シリーズ取扱説明書の記載に誤りがありました。お詫びするとともに、下記のように訂正させていただきます。

p.6 「バルクダンプのしかた」

【追加】

Part Param 1に含まれるパラメーターの情報はコントロール・チェンジ・メッセージを使って管理されるため、バルク・ダンプでは保存されません。

【誤】

ALL 下記のすべてのデータとフロント・パネルで調節できる Master、MIDI Rxに含まれるパラメーターの設定を送信します。

PF パフォーマンスの設定と、フロント・パネルで調節できる Part Param1、Part Param 2に含まれるパラメーターの設定を送信します。

【正】

ALL 本機のすべての設定情報を送信しますが、下記の設定は送信されません。

- Part Param 1に含まれるすべてのパラメーター
- MIDI RxのBank Selパラメーター、SysExパラメーター
- NRPN受信スイッチ
- MasterのDevice ID
- Monitorの設定

PF パフォーマンスの設定を送信しますが、Part Param 1に含まれるパラメーターの設定情報は送信されません。フロント・パネルで調節できるパラメーターについては、Part Param 2に含まれるパラメーター、MIDI RxのVol&Holdパラメーター、Prog Chgパラメーター、そして各パートのミュートの設定を送信します。

p.14 「リセット・オール・コントローラー」

【誤】

コントローラー	設定値
モジュレーション	0 (最小)
ボリューム	127 (最大)
パンポット	64 (中央)
エクスプレッション	0 (最小)
ホールド1	0 (オフ)
チャンネル・プレッシャー	0 (最小)
ピッチ・バンド・チェンジ	±0 (中点)
RPN	RPNナンバー未設定状態、内部データは変化しない
NRPN	NRPNナンバー未設定状態、内部データは変化しない

【正】

コントローラー	設定値
モジュレーション	0 (最小)
ソフト	0
ソステヌート	0
エクスプレッション	0 (最小)
ホールド1	0 (オフ)
チャンネル・プレッシャー	0 (最小)
ピッチ・バンド・チェンジ	±0 (中点)
RPN	RPNナンバー未設定状態、内部データは変化しない
NRPN	NRPNナンバー未設定状態、内部データは変化しない

The Sound Expansion Series Owner's Manual contained errors. We apologize for any inconvenience. Please make the following corrections.

p. 6 "How to Make a Bulk Dump"

[Addition]

Because the information for parameters included in Part Param 1 is controlled by Control Change messages, it cannot be stored using Bulk Dump.

[Wrong]

ALL Sends all of the data as well as the Parameter settings for Master and MIDI Rx that can be adjusted from the front panel.

PF Sends Performance settings and the Parameter settings for Part Param 1 and Part Param 2 that can be adjusted from the front panel.

[Correct]

ALL The information for all settings (except the ones listed below) is sent.

- All parameters included in Part Param 1
- Bank Sel and SysEx parameters for MIDI Rx
- NRPN receive switch
- Master device ID
- Monitor settings

PF Performance settings are sent, but the setting information for parameters included in Part Param 1 is not sent. For parameters that can be adjusted from the front panel, the settings that are sent are the parameters included in Part Param 2, Vol & Hold parameters for MIDI Rx, Prog Chg parameters, and the mute settings for each Part.

p.9: "Pitch Is Strange"

[Wrong]

Are the settings for Key Shift and Tune (p. 4) appropriate?

[Correct]

Are the settings for Key Shift and Tune (p. 4-5) appropriate?

p.9: "Patch Table 2 Not Obtained With GM System On or GS Reset"

[Wrong]

Make sure the "Sys Ex" setting (a switch for enabling reception of System Exclusive messages) is not set at "OFF."

[Correct]

Make sure the "Sys Ex" setting (a switch for enabling reception of System Exclusive messages) is not set at "OFF" or "PAr."

p.14: "Reset All Controllers"

[Wrong]

Controller	Value
Modulation	0 (minimum)
Volume	127 (maximum)
Panpot	64 (center)
Expression	0 (minimum)
Hold 1	0 (off)
Channel pressure	0 (minimum)
Pitch bend change	±0 (center)
RPN	No specified parameter, no value is changed.
NRPN	No specified parameter, no value is changed.

[Correct]

Controller	Value
Modulation	0 (minimum)
Soft	0
Sostenuto	0
Expression	0 (minimum)
Hold 1	0 (off)
Channel pressure	0 (minimum)
Pitch bend change	±0 (center)
RPN	No specified parameter, no value is changed.
NRPN	No specified parameter, no value is changed.

SOUND EXPANSION Sound Expansion Series

Owner's Manual

Using This Manual...

This owner's manual is for use with all models in the Sound Expansion Series. It covers virtually all the available functions, and explains how to use them. However, each model in the Sound Expansion Series also provides its own unique features, designed to deliver a great deal more expressiveness and realism within the musical realism that the model is specialized for. Since each model also has its own individual owner's manual, please refer to that manual as well.

© 1995 ROLAND CORPORATION

All rights reserved. No part of this publication may be reproduced in any form without the written permission of Roland Corporation.

Contents

Part Names and Descriptions	2
Quick Start	3
■ Connections and Power-up	3
Making the Connections	3
Before Turning On the Power	3
Turning On the Power	3
■ About the Unit's Operation Modes	3
<About the Temporary Area>	3
■ Try Listening to Sounds in the Performance Mode	3
Switching to the Performance Mode	3
Choosing a Performance	4
Changing Performance Settings	4
About the Functions for the Parameters	4
Muting a Part	5
Monitoring a Part	5
■ Try Listening to Sounds in the Patch Mode	5
Switching to the Patch Mode	5
Setting Patches	5
■ Storing the Unit's Settings	6
<How to DO a Bulk Dump>	6
Saving Settings	6
Returning Saved Settings to the Unit	6
■ Returning Settings to Their Factory Defaults (Factory Preset)	6
■ NRPN Receive Switch	6
■ How to Listen to the Demo Songs	6
■ Other Handy Functions	7
Level Meter Function	7
MIDI Monitor Function	7
■ Error Messages	7
Using MIDI Messages to Control the Unit	8
Changing Patches	8
Changing Performances	8
Changing the Patch Table	8
Reference	9
■ Parameters	9
■ Troubleshooting	9
Roland Exclusive Messages	10
MIDI IMPLEMENTATION	12
MIDI Implementation Chart	20



Part Names and Descriptions

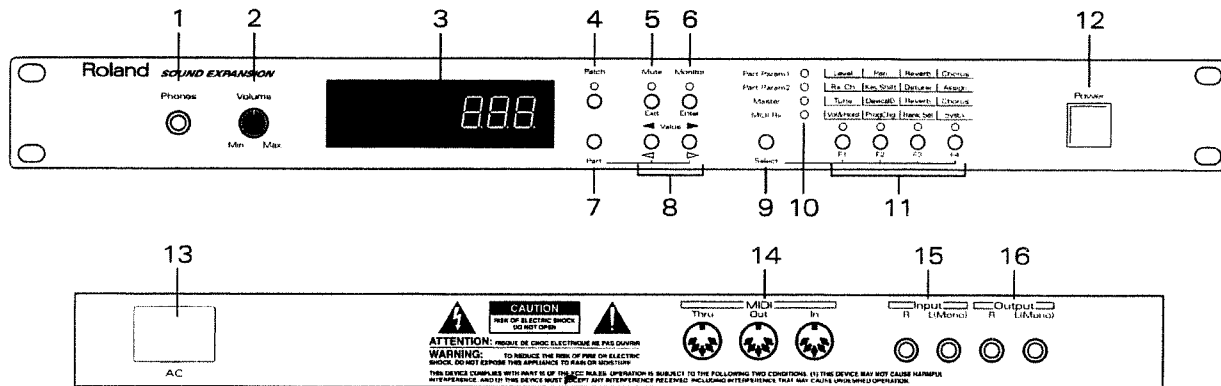

1. Phones (headphones) Jack

This is for connecting headphones. Sound still comes out of the Output L/R jacks even when headphones are plugged in.

2. Volume Knob

Used to adjust the volume of the sound output to the Output L/R jacks and the headphones jack.

3. Display

Shows the numbers assigned to Patches and the values of Parameters. It also displays messages in the event of an error.

4. Patch Button

Patches can be selected by using Value buttons when the indicator for this button is lit up or flashing.

5. Mute Button

To stop the part sounding, press this button and the indicator for this button is lit up.

6. Monitor Button

Parts for which the indicator on this button is lighted are played — all other Parts will be silent.

7. Part Button

To switch Parts, hold down the Part button while you press the Value button.

8. Value Buttons

These buttons are used to change various settings. You can reduce a value rapidly by holding down the ◀ Value button and pressing the ▶ button. In the same way, you can increase a value rapidly by holding down the ▶ Value button and pressing the ◀ button.

9. Select Button

10. Select Indicator

11. Function Buttons

These are used to change the settings for this sound module. They are also used to return values to their factory defaults (p. 6). The Select indicator also serves as a level meter for the unit (p. 7).

12. Power Switch

This is used to switch the power on and off. Press the button once to switch the power on, and press it again to return it to its original position and switch the power off.

13. AC Jack

Insert the power cord included with the unit into this jack, and plug the other end into an AC power outlet.

14. MIDI In/MIDI Out/MIDI Thru Connectors

MIDI In: Receives messages from external MIDI devices.

MIDI Out: Transmits messages from the unit to external MIDI devices (Bulk Dump: p. 6).

MIDI Thru: Provides duplicate of the complete MIDI message stream received via MIDI In, without change.

15. Input L/R Jacks

By connecting the output jacks of another sound module to these jacks, you can obtain the mixed output for the two sound modules from the Output L/R jacks and the Phones jack. If you want monaural input, connect the cable to the L jack.

The volume of the sound input to the Input L/R jacks remains constant regardless of the position of this unit's Volume knob.

16. Output L/R jacks

These jacks provide output of the audio signals. If you want monaural output, connect the audio cable to the L jack.

Quick Start

Connections and Power-up

■ Making the Connections

First make sure that the power off this unit, and on all other external devices is switched off. Then hook up the unit and the other equipment as shown below.

Use cables with 1/4" phone plugs to connect the unit's Output jacks to a keyboard amp; or to connect the unit's Input jacks with the output jacks on another device. Use MIDI cables to make connections between MIDI connectors.

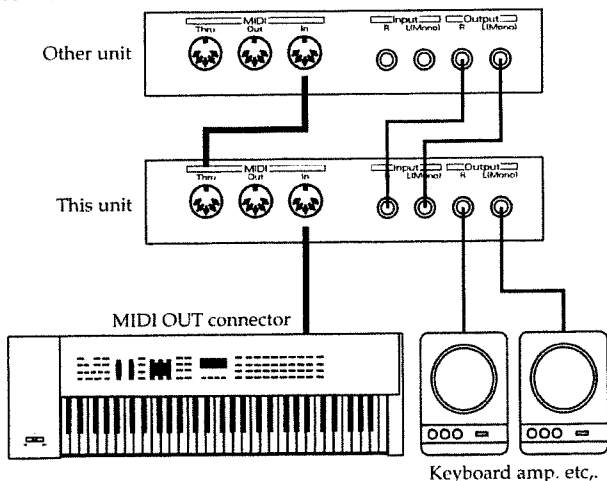

If you connect the output jacks on another sound module to the unit's Input jacks, you can listen to the sounds output from the two sound modules without using a mixer.

You can listen to the unit even if you have no keyboard amp or audio set. Just plug in headphones to the Phones jack.

■ Before Turning On the Power.....

Before you switch on the power, make sure that the unit's Volume knob is at "Min," and make sure that the volume knobs for the keyboard amp and any other external equipment are also at their lowest settings.

■ Turning On the Power

First switch on the power for the unit, and then turn on the keyboard amp or other connected equipment. After you've done that, adjust the unit's Volume knob and the volume controls on the other equipment to get the appropriate sound level. When switching off the power, first turn off the keyboard amp or other equipment, and then switch off the unit.

* This unit is equipped with a protection circuit. A brief interval (a few seconds) after power up is required before the unit will operate normally.

About the Unit's Operation Modes

This unit has a Performance mode and a Patch mode. In the Performance mode, it functions as a multi-timbral sound generator capable of playing eight Parts. In the Patch mode, it works as a sound generator which focuses on playing just a single Part.

The Performance mode can be used for ensemble play with a sequencer, and the Patch mode works well for live-stage performances with a MIDI keyboard hooked up.

About the Temporary Area

When a Performance or Patch is called up, the information for its settings is stored in a temporary area. The only Performances and Patches that you can play with MIDI messages from the MIDI In connector, or can manipulate with the buttons on the front panel are the Performances and Patches that have been read into the temporary area.

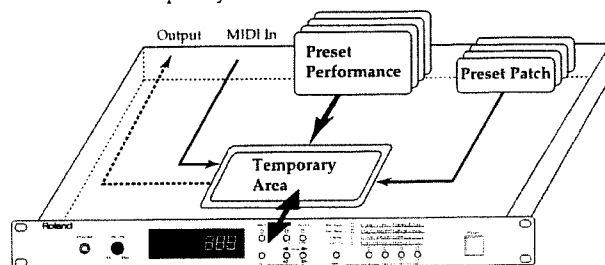

You can change the parameters for Performance or Patch that has been called up into the temporary area. You can also change parameters remotely using an external MIDI device connected to the MIDI in connector.

The data in the temporary area is preserved in memory even while the power is off.

Note, however, that if you select another Performance or Patch, settings data in the temporary area before that is discarded.

You can also output the setting values through the MIDI Out connector for storage on an external MIDI device (p. 6).

Try Listening to Sounds in the Performance Mode

This unit has a large number of built-in Performances. A "Performance" is a collection of many settings, including Patches assigned to Parts 1 to 7, Rhythm Set values assigned to Part 8, and the values for Level, Pan, and Effects for each of these Parts.

■ Switching to the Performance Mode.....

You can start up the unit in the Performance mode by switching on the power while holding down the Part button. This setting remains in memory even after the power is switched off.

* The unit is set to the Performance mode when shipped from the factory.

Quick Start

■ Choosing a Performance.....

Hold down the Select button and press the F1 button. "PF" appears on the display. Then the currently selected Performance number appears on the display, as shown below.



While in this state, you can use the Value buttons to choose a Performance. Pressing the Enter button makes it possible to start playing with the selected Performance. To cancel instead, press the Exit button.

For more information on the settings for each Performance, refer to the Performance Chart in the owner's manual for the particular model that you're using.

■ Changing Performance Settings

If the MIDI receive channels set for the various Parts don't match the MIDI send channels used by the connected MIDI keyboard, no sound is played.

Try changing the settings for the Patches and Effects assigned to the Parts to modify a Performance to suit your own style of play. Here's how to change these settings.

• Choosing a Part

To switch Parts, hold down the Part button while you press / . The display shows you which Part is selected — for example, "P-1" on the display indicates "Part 1"; and "P-2" means "Part2."

The figure below shows how the display looks when Part 1 has been selected.



• Changing the Patches and Rhythm Set

Press the Patch button to make the indicator light up, and then use the Value buttons to choose the desired Patches or Rhythm Set.

* A Rhythm Set can be assigned only to Part 8.

• Changing Parameter Settings

You can make changes to the various Parameters printed on the right-hand side of the unit's front panel.

Choose the Parameter Group with the Select button, and then use the F1, F2, F3, or F4 button to select the Parameter. The lit-up indicator shows you which Parameter has been selected.

In the example below, the Key Shift Parameter is selected.

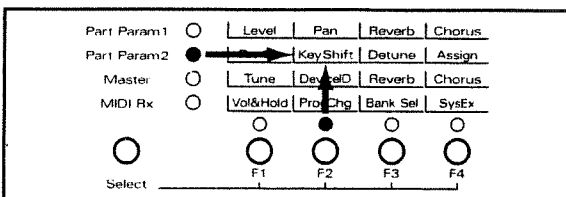

View the value shown in the display while using the Value buttons to change the value.

■ About the Functions for the Parameters

The Parameters that make up Part Param 1, Part Param 2 and a part of MIDI Rx (Vol&Hold, Prog Chg) can be set independently for each Part. The Parameters contained in Master and a part of MIDI Rx (Bank Sel, SysEx) are set commonly for all Parts.

See the Parameter Chart on page 9 for a description of each Parameter's possible range and their default values.

• Part Param 1 (Part Parameter 1)

Level: This adjusts the volume level for each Part.

Pan: Allows you to localize the sound image for each Part. At "0," the sound is centered in the stereo field. Settings of "L1" to "L64" place the sound at positions toward the left, with a larger number indicating a further distance away from the center. In the same way, settings of "r1" to "r63" position the sound to the right, with a larger number indicating a further distance away from the center.

Reverb (Reverb Level): This sets the depth of the Reverb effect (reverberation effect) for each of the Parts.

Chorus (Chorus Level): This sets the depth of the Chorus effect (an effect that makes the sound "fatter") that is applied to each Part.

There are patches that are set the chorus output send to reverb. The chorus level is changed, and the reverb level changes when using the these patches.

• Part Param 2 (Part Parameters 2)

Rx Ch (MIDI Receive Channel): This sets the MIDI receive channel for each Part.

Key Shift: This alters, in half-steps, the pitch at which each Part is played. This pitch is raise (or lowered) by an octave for each setting of +12 (or -12).

This parameter is set to too high or low value, and this unit might not sound or make strange sound in key range.

Detune: This is used to make fine adjustments in the pitch for each Part. The pitch is raised (or lowered) by half a semitone for each setting of +50 (or -50).

Assign (Voice Assign): This assigns a minimum number of voices available for play by a Part. This unit can simultaneously play a maximum of 28 voices. If you are using a sequencer to play complex arrangements, the number of voices available may not be enough, and some notes could be dropped.

If this happens, you may want to assign a number of voices that are required for certain Parts to prevent voices for such important Parts from being stolen, even when the total number of simultaneous notes exceeds 28. Remember, however, that the total number of voices assigned to all Parts together cannot be greater than 28.

• **Master Parameters**

Tune: This adjusts the pitch that becomes the overall standard for the unit (middle A = A4). This display shows "27.4 Hz" to "52.6 Hz," which represents a value of from 427.4 Hz to 452.6 Hz.

Device ID: The same model ID may be held by other sound modules in this series, or by the JV-80, JV-90, JV-1000, or JV-880. The device ID is information that is used to individually distinguish each device when MIDI devices are used together. If you are using any of the above units at the same time, change the device ID when sending system exclusive (SysEx) messages to them.

Reverb (Reverb Switch): This toggles the reverb effect for the entire unit on or off.

Chorus (Chorus Switch): This toggles the chorus effect for the entire unit on or off.

• **MIDI Rx (MIDI Message Reception)**

Vol&Hold (Volume/Hold Message Reception Switch): Determines whether Volume and/or Hold messages are to be received or not. The meaning of the settings shown in the display is as follows:

- on* Volume messages and hold messages are both received.
- hLd* Hold messages are received, but volume messages are not.
- uOL* Volume messages are received, but hold messages are not.
- oFF* Neither volume messages nor hold messages are received.

Prog Chg (Program Change Message Receive Switch): Allows you to enable/disable reception of Program Change messages. Program Change messages are accepted when "on" is displayed, and ignored when "oFF" is selected.

Bank Sel (Bank Select Message Reception): This changes the unit's Patch, using a Bank Select message (Controller Number 0 or 32) in combination with a Program Change message. When shipped from the factory the Patch can be changed with a Controller Number 0 value of 80 or 81. The display reads "80" at this time. When the display shows "0," Patches can be switched with Controller Number 0 values of 0 and 1. Similarly, Patches can be switched with Controller Number 0 values of 10 and 11 when "10" is shown. You can set this value to any number from 0 to 126. When set to "oFF," no Bank Select messages are received. When the Patch Table set to "2," this parameter cannot be work.

SysEx (System Exclusive Message Receive Switch): This setting determines whether or not system exclusive messages are received. Bulk Dump data is also one type of system exclusive message.

- on* System Exclusive message is received.
- PAr* System Exclusive message other than "GS Reset," "Exit GS," "GM System On," or "GM System Off" is received.
- oFF* System Exclusive message is not received.

■ **Muting a Part**

Parts for which the Mute button is pressed (the indicator lights) will remain silent.

■ **Monitoring a Part**

After pressing the Monitor button to light up the indicator, only one Part will be heard at a time, with all other Parts muted out. During ensemble play with a sequencer, it can sometimes be hard to tell how each Part is being played. At such times, you can activate the Monitor button (get its indicator to light) and then switch through the Parts to listen to how each is played.

■ **Try Listening to Sounds in the Patch Mode**

In the Patch mode, the unit functions as a sound generator for just one Part. Reverb and Chorus can be selected for each Patch in this mode, which can give you powerful sounds for live performances.

■ **Switch to the Patch Mode**

The Patch mode is enabled by switching on the power while holding down the Patch button. This setting remains in memory even after the power is switched off. The indicator for the Patch button flashes when in the Patch mode.

■ **Setting Patches**

In the same way as for the Performance mode, you can make changes to the various Parameters printed on the right-hand side of the unit's front panel. The functions of the Parameters are no different from the Performance mode — check out "Changing Parameter Settings" (p. 4) for more information. However, Key Shift, Detune and Assign parameter of the Part Param 2 and Vol&Hold, Prog Chg parameter of the MIDI Rx doesn't work in the Patch mode. When these parameters are selected, "---" appears on the display as shown below.



Quick Start

Storing the Unit's Settings

You can transmit the information for the unit's settings from the MIDI Out connector. This function is called a "Bulk Dump." This sends the unit's data to a sequencer or some other MIDI device in real-time for storage on the other device. You can also use this function to return settings stored on another device to the unit.

How to Do a Bulk Dump

Hold down the select button and press the F2 button. "bd" appears on the display. Then use the Value buttons to select the information that you want to send.

- ALL* Sends all of the data as well as the Parameter settings for Master and MIDI Rx that can be adjusted from the front panel.
- PF* Sends Performance settings and the Parameter settings for Part Param 1 and Part Param 2 that can be adjusted from the front panel.
- PAT* Sends the information for Patches assigned to Parts 1 to 7.
- rhy* Sends the settings for the Rhythm Set assigned to Part 8.

* The display and operation shown above explain the usage when in the Performance mode. In the Patch mode, the selections "PF" and "rhy" are not available. Also, selecting "Pat" causes the information for only one Patch to be sent.

After starting recording on the sequencer, press the unit's Enter button. The Bulk Dump is executed when you press this button. If you want to cancel the Bulk Dump, press the Exit button.

■ Saving Settings.....

To save the unit's setting data, connect its MIDI Out connector to the MIDI In connector on a sequencer (or some other MIDI device), and then set the unit's Device ID number (p. 5). When you've done this, start recording on the sequencer and execute a Bulk Dump. After the Bulk Dump has finished, stop recording on the sequencer.

■ Returning Saved Settings to the Unit

To load settings data back into the unit, connect the MIDI Out connector on the sequencer to the unit's MIDI In connector. Make sure that the unit's Device ID number (p. 5) is set to the same number that was used when the settings were save. Also check to make sure that the System Exclusive Message Receive Switch (p. 5) is set to "on."

After you have checked these, send the settings data stored on the sequencer to the unit.

If you record Bulk Dump data at the start of a batch of music data, you can set up the unit simply by sending the song data to the unit.

Returning Settings to Their Factory Defaults (Factory Preset)

This returns all of the unit's settings to the data in effect when the unit was shipped from the factory.

Hold down the Select button and press F3. When the message "FP" flashes on the display, confirm that you want to go ahead by pressing the Enter button. Press the Exit button instead if you change your mind.

NRPN Receive Switch

If you hold down the Select button and press F4, "nrP" flashes on the display. After this disappears, you can use the Value button to select "on" or "oFF." When set to "on," you can use an NRPN (non-registered parameter number) to edit the unit's Patches and Rhythm Sets. This is automatically set to "on" when a GS Reset or GM System On message is received.

When at "oFF," a Patch or Rhythm Set cannot be edited even when an NRPN is received. The setting is always at "oFF" when the power is switched on.

* No GS Reset or GM System On messages are received when the SysEx parameter is set to "oFF" or "PAr."

How to Listen to the Demo Songs

Holding down the Select button as you switch on the power makes it possible to listen to the demo songs. Use the Value buttons to choose a song number. The Demo song is played back when you press the Enter button. Pressing the Exit button stops playback.

Press the Exit button once more, you can play this unit it was. For more information on the Demo songs, see the owner's manual for the particular model that you're using.

Other Handy Functions

■ Level Meter Function

When the indicator for a Patch button is lit up or flashing, the Select indicator works like a level meter for the unit. It normally indicates the total level for all Patches taken together, but when you're monitoring a Part it indicates only the level for that Part.

■ MIDI Monitor Function.....

You can display the status of receiving MIDI messages for each Part (Note messages only). If you hold down the Part button, the Select indicator and the indicators for the F1 to F4 buttons will light up while the Part button is held down. The following figure shows the relationship between the Part and the indicators.

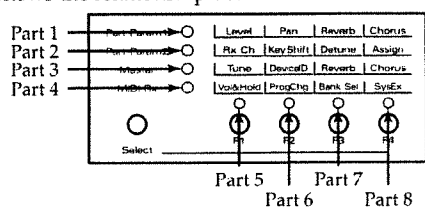

Error Messages

$\square \square P$ (No Patch)

Patch not found in the Bank specified by means of Program Change and/or Controller No. 0 & 32 messages.

$b \ell L$ (Battery Low)

The battery required for preserving parameter settings is nearly depleted. Consult with the nearest Roland Service Station.

$\square FL$ (MIDI Off Line)

MIDI communications have been disrupted. Consider if the cable connected to MIDI In is faulty, or if there could be a problem with the external device. (The error will appear if the external device has been switched off.)

$b FL$ (MIDI Buffer Full)

Data could not be processed successfully because too much was received within a short period of time.

$\subset SE$ (MIDI Checksum Error)

A checksum contended in System Exclusive messages received by the unit was found to be in error.

* Should an error other than those explained above (such as Er1, Er2, etc.) appear, you should consult with the nearest Roland Service Center or other authorized service personnel.

Using MIDI Messages to Control the Unit

This unit can send and receive the MIDI messages indicated by "O" in the MIDI Implementation Chart on page 20. You can use these MIDI message external device. For details, see "MIDI Implementation" (p. 12). Read on for an explanation of some typical functions that you can use.

■ Changing Patches

This unit has more than 128 built-in Patches, so it's not possible to select every Patch with just Program Change messages. For this reason, Patches can be switched by using Program Change messages together with Bank Select messages.

A Bank Select message is a combination of Controller Number 0 and Controller Number 32, but this unit always treats the value of Controller Number 32 as "0" (zero).

When the unit is shipped from the factory, you can select Patches from 1 to 128 with a value of 80 for Controller Number 0 and with the Program Number. You can select Patches from 129 to 255 with a value of 81 for Controller Number 0 and with the Program Number. This is shown in the following figure.

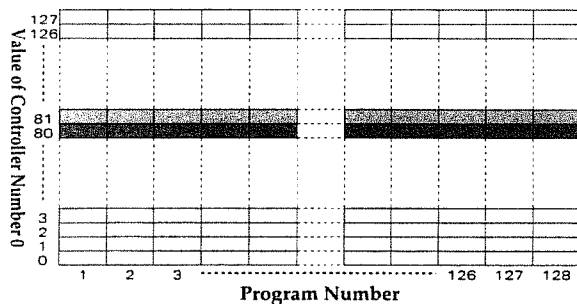

To change a Patch, send MIDI messages from the external device in the sequence shown below.

- Controller Number 0
 - Value: 80 (Patches 1 to 128)
 - Value: 81 (Patches 129 to 256)
- Controller Number 32
 - Value: 0
- Program Number
 - Value: 1 to 128

The Patch is changed when the MIDI messages are received in this sequence. If you sent only a Program Number without sending Controller Number 0, the previously sent value for Controller Number 0 and the Program Number just sent are used to choose the Patch.

- * When shipped from the factory, the unit is set up for switching patches with a value of 80 or 81 for Controller Number 0, but you can modify the Bank Sel parameter (p. 5) to change the value for Controller Number 0 that is used to switch Patches.
- * The number of Patches varies from one model to another.
- * If you specify a Bank in which a Patch is not assigned, the message "noP" (no Patch) appears on the display and no sound is played. Press the Value button to return to the previous display. Refer to the owner's manual for the particular model you are using for descriptions of the Patches assigned to the different Banks.

■ Changing Performances.....

You can also use Program Change messages to change the Performance. When shipped from the factory, however, the unit was set so this feature is disabled. See "MIDI Implementation" (p. 16: Control channel) for more details.

■ Changing the Patch Table

This unit has two Patch Tables. Patch Table 1 (details of which can be found in the owner's manuals for the particular model that you're using) is enabled when the unit's power is switched on, but changes to Patch Table 2 when a General MIDI System On or GS Reset message is received. You can switch back to Patch Table 1 by sending a General MIDI System Off or Exit GS message to the unit; or by switching the power off, then on again.

See the owner's manual for the particular model that you're using for information on the Patch Table 2.

- * This unit receives GS reset or GM system on message when it is set to Patch mode, automatically change to Performance mode.
- * If SysEx parameter (p.5) set to "oFF" or "PAr," this unit doesn't change to Patch Table 2 because of this unit doesn't receive GM system on and GS reset message.

Important!

When Patch Table 2 has been selected, a dot appears in the lower left corner of the display, as shown below.



Reference

Parameters

• Part Param 1

Parameter	Value
Level	0 — 127
Pan	L64 — 0 — r63
Reverb	0 — 127
Chorus	0 — 127

• Part Param 2

Parameter	Value
Rx Ch	1 — 16
Key Shift	-48 — 0 — +48
Detune	-50 — 0 — +50
Assign	0 — 28

• Master

Parameter	Value
Tune (°)	427.4 — 452.6 Hz
Device ID	1 — 32
Reverb	oFF, on
Chorus	oFF, on

• MIDI Rx Sw

Parameter	Value
Vol&Hold	oFF, voL, hLd, on
Prog Chg	oFF, on
Bank Sel	oFF, 0 — 126
Sys Ex	oFF, PAr, on

(*) The hundreds digit (always 4) is not displayed.

Troubleshooting

If your unit is not providing the expected response, check through the following for a ready solution.

• Power Doesn't Come On

Make sure the power cord is connected properly (both the plug going to this unit and the one at the outlet).

• Sound Not Produced

Recheck that power is indeed switched on — on this unit as well as any other devices (keyboard amp, mixer, etc.).

Could the volume be turned down too low on this unit, or on your keyboard amp, mixer, or other device?

Are all your cable connected properly?

Could any of the cables possibly be faulty?

Check settings for "Level" (p. 4) to make sure they are not at "0."

Could the volume possibly have been lowered by MIDI messages sent to the unit by another device (such as Controller Number 7 or 11)?

Have you checked to make sure that the channel number being used by the keyboard or sequencer for transmission is the same as what this unit is set to be receiving on?

Could you futilly be trying to play while a Demo is playing?

Have you checked that relevant Parts are not set to be muted?
Could you be sending an invalid Bank Select message?

• Reverb/Chorus Not Obtained

Could the Master setting for Reverb or Chorus be set to "oFF"?

Are you sure that the Part Param 1 settings for Reverb or Chorus are not set to a value that is too low?

• Distortion or Other Noise Is Heard

Is the volume at a suitable level on this unit, or on your keyboard amp, mixer, or other device?

Could you possibly be using an excessively high level for this unit's Level (p. 4) and Master Level? (These settings are alterable only through System Exclusive messages.)

Have the Output or Phones jacks gotten very dirty?

• Pitch Is Strange

Are the settings for Key Shift (p. 4) and Tune (p. 5) appropriate?

Are Pitch Bend messages being constantly sent to the unit?

• Sound Doesn't Change

Could you have Prog Chg or Bank Sel (p. 5) switched off?

If sending Bank Select messages and/or Program Change message, make sure you are sending them in the correct order.

• Multiple Sounds Heard at the Same Time

Check the channels you have assigned to Parts. The same channel could be assigned to more than one Part.

• Notes Get Dropped

The maximum polyphony of the unit is 28 notes. Not all notes can be played if you attempt to sound more than this at the same time. To avoid having voices stolen from your most important Parts, use the (Voice) Assign setting to reserve a minimum number of voices for those Parts you want to sound.

• Patch Table 2 Not Obtained With GM System On or GS Reset

Make sure the "Sys Ex" setting (a switch for enabling reception of System Exclusive messages) is not set at "oFF."

Roland Exclusive Messages

1. Data Format for Exclusive Messages

Roland's MIDI implementation uses the following data format for all Exclusive messages (type IV):

Byte	Description
F0H	Exclusive Status
41H	Manufacturer ID (Roland)
DEV	Device ID
MDL	Model ID
CMD	Command ID
[BODY]	Main data
F7H	End of exclusive

•MIDI status: F0H, F7H

An Exclusive message must be flanked by a pair of status codes, starting with a Manufacturer ID immediately after F0H (MIDI version 1.0).

•Manufacturer ID: 41H

The Manufacturer ID identifies the manufacturer of a MIDI instrument that sends an Exclusive message. Value 41H represents Roland's Manufacturer ID.

•Device ID: DEV

The Device ID contains a unique value that identifies individual devices in the implementation of several MIDI instruments. It is usually set to 00H-0FH, a value smaller by one than that of a basic channel, but value 00H-1FH may be used for a device with several basic channels.

•Model ID: MDL

The Model ID contains a value that identifies one model from another. Different models, however, may share an identical Model ID if they handle similar data.

The Model ID format may contain 00H in one or more places to provide an extended data field. The following are examples of valid Model IDs, each representing a unique model:

01H
02H
03H
00H, 01H
00H, 02H
00H, 00H, 01H

•Command ID: CMD

The Command ID indicates the function of an Exclusive message. The Command ID format may contain 00H in one or more places to provide an extended data field. The following are examples of valid Command IDs, each representing a unique function:

01H
02H
03H
00H, 01H
00H, 02H
00H, 00H, 01H

•Main data: BODY

This field contains a message to be exchanged across an interface. The exact data size and content will vary with the Model ID and Command ID.

2. Address-mapped Data Transfer

Address mapping is a technique for transferring messages conforming to the data format given in Section 1. It assigns a series of memory-resident records—waveform and tone data, switch status, and parameters, for example, to specific locations in a machine-dependent address space, thereby allowing access to data residing at the address a message specifies.

Address-mapped data transfer is therefore independent of models and data categories. This technique allows use of two different transfer procedures: one-way transfer and handshake transfer.

•One-way transfer procedure (See Section 3 for details.)

This procedure is suited to the transfer of a small amount of data. It sends out an Exclusive message completely independent of the receiving device's status.

Connection Diagram

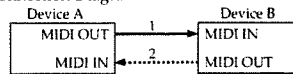

Connection at point 2 is essential for "Request data" procedures. (See Section 3.)

•Handshake-transfer procedure (This device does not use this procedure)

This procedure initiates a predetermined transfer sequence (handshaking) across the interface before data transfer takes place. Handshaking ensures that reliability and transfer speed are high enough to handle a large amount of data.

Connection Diagram

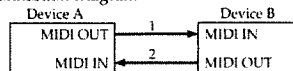

Connection at points 1 and 2 is essential.

Notes on the above procedures

- * There are separate Command IDs for different transfer procedures.
- * Devices A and B cannot exchange data unless they use the same transfer procedure, share identical Device ID and Model ID, and are ready for communication.

3. One-way Transfer Procedure

This procedure sends out data until it has all been sent and is used when the messages are so short that answerbacks need not be checked.

For longer messages, however, the receiving device must acquire each message in time with the transfer sequence, which inserts 20 milliseconds intervals.

Types of Messages

Message	Command ID
Request data 1	RQ1 (11H)
Data set 1	DT1 (12H)

•Request data #1: RQ1 (11H)

This message is sent out when there is a need to acquire data from a device at the other end of the interface. It contains data for the address and size that specify designation and length, respectively, of data required.

On receiving an RQ1 message, the remote device checks its memory for the data address and size that satisfy the request.

If it finds them and is ready for communication, the device will transmit a "Data set 1 (DT1)" message, which contains the requested data. Otherwise, the device won't send out anything.

Byte	Description
F0H	Exclusive Status
41H	Manufacturer ID (Roland)
DEV	Device ID
MDL	Model ID
11H	Command ID
aaH	Address MSB
	LSB
ssH	Size MSB
	LSB
sum	Check sum
F7H	End of exclusive

- * The size of the requested data does not indicate the number of bytes that will make up a DT1 message, but represents the address fields where the requested data resides.
- * Some models are subject to limitations in data format used for a single transaction. Requested data, for example, may have a limit in length or must be divided into predetermined address fields before it is exchanged across the interface.
- * The same number of bytes comprises address and size data, which, however, vary with the Model ID.
- * The error-checking process uses a checksum that provides a bit pattern where the last 7 bits are zero when values for an address, size, and that checksum are summed.

•Data set 1: DT1 (12H)

This message corresponds to the actual data transfer process. Because every byte in the data is assigned a unique address, a DT1 message can convey the starting address of one or more bits of data as well as a series of data formatted in an address-dependent order.

The MIDI standards inhibit non real-time messages from interrupting an Exclusive one. This fact is inconvenient for devices that support a "soft-thru" function. To maintain compatibility with such devices, Roland has limited the DT1 to 256 bytes so that an excessively long message is sent out in separate 'segments'.

Byte	Description
F0H	Exclusive Status
41H	Manufacturer ID (Roland)
DEV	Device ID
MDL	Model ID
12H	Command ID
aaH	Address MSB
	LSB
ddH	Data MSB
	LSB
sum	Check sum
F7H	End of exclusive

- * A DT1 message is capable of providing only the valid data among those specified by an RQ1 message.
- * Some models are subject to limitations in data format used for a single transaction. Requested data, for example, may have a limit in length or must be divided into predetermined address fields before it is exchanged across the interface.
- * The number of bytes comprising address data varies from one Model ID to another.
- * The error-checking process uses a checksum that provides a bit pattern where the last 7 bits are zero when values for an address, size, and that checksum are summed.

•Example of Message Transactions

•Device A sending data to Device B

Transfer of a DT1 message is all that takes place.

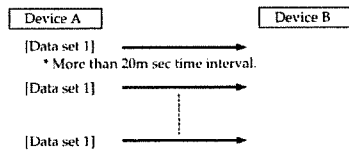

•Device B requesting data from Device A

Device B sends an RQ1 message to Device A. Checking the message, Device A sends a DT1 message back to Device B.

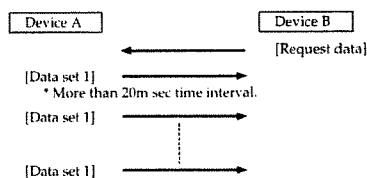

1. RECEIVE DATA

Channel Voice Message

• Note Off

Status	Second	Third
8nH	kkH	vvH
9nH	kkH	00H

n = MIDI channel number: 0H — FH (ch.1 — ch.16)
kk = Note number: 00H — 7FH (0 — 127)
vv = velocity: 00H — 7FH (0 — 127)

In the performance mode, ignored when the "MIDI receive switch" is OFF for each part.
In the rhythm part (part 8), ignored when "ENV mode" is at "NO-SUSTAIN" for each rhythm tone.

• Note On

Status	Second	Third
9nH	kkH	vvH

n = MIDI channel number: 0H — FH (ch.1 — ch.16)
kk = Note number: 00H — 7FH (0 — 127)
vv = velocity: 01H — 7FH (1 — 127)

In the performance mode, ignored when the "MIDI receive switch" is OFF for each part.

Control change

• Bank select

Status	Second	Third
BnH	00H	mmH
BnH	20H	llH

n = MIDI channel number: 0H — FH (ch.1 — ch.16)
mm = MSB of the bank number: 50H — 51H (80 — 81)
"mm" is adjustable from 0, 1 to 126, 127.
ll = LSB of the bank number: 0H (0)

The Bank Select is suspended until receiving a program change.
This message is ignored when "Program bank sel" of the system common is OFF.
If the part which MIDI receive channel is set the same as the control channel, the performance is changed when receive the bank select message.

The bank number specified as following.

Bank select		Program change	Media (Patch number)
MSB	LSB	1 — 128	Preset A (#1 — #128)
B1	0	1 — 127	Preset B (#129 — #255)

When the module receives bank select LSB, it will always count as 0.

• Modulation

Status	Second	Third
BnH	01H	vvH

n = MIDI channel number: 0H — FH (ch.1 — ch.16)
vv = Modulation depth: 00H — 7FH (0 — 127)

The effect of the modulation depends on the value of "Mod1 — 4" of the patch tone.
This message is ignored when "Receive Modulation" of the system common is OFF.

• Portamento time

Status	Second	Third
BnH	05H	vvH

n = MIDI channel number: 0H — FH (ch.1 — ch.16)
vv = Portamento time: 00H — 7FH (0 — 127)

You can adjust the portamento time of the patch common.
This message is ignored when "Receive Control change" of the system common is OFF.

• Volume

Status	Second	Third
BnH	07H	vvH

n = MIDI channel number: 0H — FH (ch.1 — ch.16)
vv = Volume: 00H — 7FH (0 — 127)

You can adjust the volume of specified channel.
This message is ignored when "Receive volume" of the system common is OFF.

In the performance mode, ignored when the "Receive volume switch" is OFF for each part.
This message is ignored when "Volume switch" of the patch tone is OFF.

• Pan

Status	Second	Third
BnH	0AH	vvH

n = MIDI channel number: 0H — FH (ch.1 — ch.16)
vv = Pan: 00H — 7FH (0 — 127)

0 represents the left end, 64 the center, and 127 the right end.
This message is ignored when "Receive Control Change" of the system common is OFF.

• Expression

Status	Second	Third
BnH	0BH	vvH

n = MIDI channel number: 0H — FH (ch.1 — ch.16)
vv = Expression: 00H — 7FH (0 — 127)

The effect of the expression depends on the value of "Exp1 — 4" of the patch tone.
This message is ignored when "Receive Control Change" of the system common is OFF.

• Hold 1

Status	Second	Third
BnH	40H	vvH

n = MIDI channel number: 0H — FH (ch.1 — ch.16)
vv = Control value: 00H — 7FH (0 — 127) 0 — 63 = OFF, 64 — 127 = ON

Note played can be sustained for as long as the time that elapses between turning hold on and off.
This message is ignored when "Receive Control Change" of the system common is OFF.
In the performance mode, ignored when the "hold1 receive switch" is OFF for each part.
In the rhythm part (part 8), ignored when "ENV mode" is at "NO-SUSTAIN" for each rhythm tone.
This message is ignored when "Hold-1 switch" of patch tone is OFF.

• Portamento

Status	Second	Third
BnH	41H	vvH

n = MIDI channel number: 0H — FH (ch.1 — ch.16)
vv = Control value: 00H — 7FH (0 — 127) 0 — 63 = OFF, 64 — 127 = ON

Switches over "Portamento sw" of patch common.
This message is ignored when "Receive control change" of the system common is OFF.

• Sostenuto

Status	Second	Third
BnH	42H	vvH

n = MIDI channel number: 0H — FH (ch.1 — ch.16)
vv = Control value: 00H — 7FH (0 — 127) 0 — 63 = OFF, 64 — 127 = ON

• Soft

Status	Second	Third
BnH	43H	vvH

n = MIDI channel number: 0H — FH (ch.1 — ch.16)
vv = Control value: 00H — 7FH (0 — 127)

The value is changed, and the "Soft" effect change.

• Effect 1 depth (Reverb send level)

Status	Second	Third
BnH	5BH	vvH

n = MIDI channel number: 0H — FH (ch.1 — ch.16)
vv = Control value: 00H — 7FH (0 — 127)

You can adjust the Reverb send level of specified channel.
This message is ignored when "Receive control change" of the system common is OFF.

• Effect 3 depth (Chorus send level)

Status	Second	Third
BnH	5DH	vvH

n = MIDI channel number: 0H — FH (ch.1 — ch.16)
vv = control value: 00H — 7FH (0 — 127)

You can adjust the Chorus send level of specified channel.
This message is ignored when "Receive control change" of the system common is OFF.

• NRPN MSB/LSB

Status	Second	Third
BnH	63H	mmH
BnH	62H	llH

n = MIDI channel number: 0H — FH (ch.1 — ch.16)
mm = MSB of the specified parameter by NRPN
ll = LSB of the specified parameter by NRPN

When the power is turned on, or "General MIDI System On" is received, Rx.NRPN will be set OFF, and NRPN will not be received.

When "GS reset" or Rx.NRPN = 0H is received, NRPN can be received.
The value set by NRPN will not be reset even if Program change or Reset all controller is received.

•• NRPN ••

The NRPN (Non Registered Parameter number) message allows an extended range of control changes to be used, letting you use control messages which are not part of the MIDI Specification and may be unique to an individual model. To use these messages, you must first use NRPN MSB and NRPN LSB message to specify the parameter to be controlled, and then use Data Entry messages to specify the value of the specified parameter. Once an NRPN parameter has been specified, all Data Entry messages received on that channel will modify the value of that parameter. To prevent accidents, it is recommended that you set RPN Null (RPN Number = 7FH/7FH) when you have finished setting the value of the desired parameter.

On This module, the following NRPN can be received.

NRPN MSB LSB	Data entry MSB	Function and range
01H 08H	mmH	Vibrato Rate (relative change) mm: 0EH — 40H — 72H (-50 — 0 — +50)
01H 09H	mmH	Vibrato Depth (relative change) mm: 0EH — 40H — 72H (-50 — 0 — +50)
01H 0AH	mmH	Vibrato Delay (relative change) mm: 0EH — 40H — 72H (-50 — 0 — +50)
01H 20H	mmH	TVF Cutoff Frequency (relative change) mm: 0EH — 40H — 72H (-50 — 0 — +50)
01H 21H	mmH	TVF Resonance (relative change) mm: 0EH — 40H — 72H (-50 — 0 — +50)
01H 63H	mmH	TVF&TVA Envelope Attack Time (relative change) mm: 0EH — 40H — 72H (-50 — 0 — +50)
01H 64H	mmH	TVF&TVA Envelope Decay Time (relative change) mm: 0EH — 40H — 72H (-50 — 0 — +50)
01H 66H	mmH	TVF&TVA Envelope release Time (relative change) mm: 0EH — 40H — 72H (-50 — 0 — +50)
18H rrH	mmH	Rhythm Instrument Pitch Coarse (relative change) rr: Rhythm Instrument note number mm: 00H — 40H — 7FH (-64 — 0 — +63 semitone)
1AH rrH	mmH	Rhythm Instrument TVA level (absolute change) rr: Rhythm Instrument note number mm: 00H — 7FH (0 — max)
1CH rrH	mmH	Rhythm Instrument Panpot (absolute change) rr: Rhythm Instrument note number mm: 00H, 01H — 40H — 7FH (random, left-center-right)
1DH rrH	mmH	Rhythm instrument Reverb Send Level (absolute change) rr: Rhythm Instrument note number mm: 00H — 7FH (0 — max)
1EH rrH	mmH	Rhythm Instrument Chorus Send Level (absolute change) rr: Rhythm Instrument note number mm: 00H — 7FH (0 — max)

Data entry LSB (llH) is ignored
Parameters marked "relative change" change relative to the preset value (40H). Even among different GS devices, "relative change" parameters may sometimes differ in the way the sound changes or in the range of change.
Parameters marked "absolute change" will be set to the absolute value of the parameter, regardless of the preset value.

• RPN MSB/LSB

Status	Second	Third
BnH	65H	mmH
BnH	64H	llH

n = MIDI channel number: 0H — FH (ch.1 — ch.16)
mm = MSB of the specified parameter by RPN
ll = LSB of the specified parameter by RPN

•• RPN ••

RPN (registered parameter number) is a parameter number of tone color or musical expression defined in MIDI specification.

With the Sound Expansion Series as the receiver, RPN#0 (pitch bend sensitivity), RPN#1 (fine tuning) and RPN#2 (coarse tuning) are effective. when sending an RPN to the Sound Expansion Series, first specify the MSB and LSB of the RPN to be used to control a parameter and then set the value in the data entry field.

RPN MSB LSB	Data entry MSB LSB	Description
00H 00H	mmH —	Pitch bend sensitivity mm: 00H — 0CH (0 — 12 semitone) ll: Ignored Up to 1 octave You can adjust "BENDER — RANGE DOWN" and "BENDER — RANGE UP" at same time. In the rhythm part (partB), this message is not recognized.
00H 01H	mmH llH	Fine tuning mm, ll: 20H, 00H — 40H, 00H — 60H, 00H (-8192 x 50 / 8192 — 0 — +8192 x 50 / 8192 cent) In the patch mode, the master tune is adjusted. In the performance mode, fine tune at each part is adjusted. In the performance mode, when received as specified control channel, the master tune is adjusted.
00H 02H	mmH —	Coarse tuning mm: 10H — 40H — 70H (-48 — 0 — +48 semitone) ll: Ignored In the patch mode, this message is not recognized. In the performance mode, coarse tune for each part is adjusted.
7FH 7FH	— —	RPN reset mm, ll: Ignored It returns to the state where no RPN parameters are specified. Current setting value is no change.

• Data entry MSB/LSB

Status	Second	Third
BnH	06H	mmH
BnH	26H	llH

n = MIDI channel number: 0H — FH (ch.1 — ch.16)
mm = MSB of the value of the parameter specified with RPN
ll = LSB of the value of the parameter specified with RPN

This message is ignored when "Receive control change" of the system common is OFF.

• Program Change

Status	Second
CnH	ppH

n = MIDI channel number: 0H — FH (ch.1 — ch.16)
pp = Program number: 00H — 7FH (prog.1 — prog.128)

This message is ignored when "Receive program change" of the system common is OFF.
If the part which MIDI receive channel is set the same as the control channel, the performance is changed when receive the program change message.

• Channel pressure

Status	Second
DnH	vvH

n = MIDI channel number: 0H — FH (ch.1 — ch.16)
vv = value: 00H — 7FH (0 — 127)

The effect of the Channel pressure depends on the value of "After 1 — 4" of the patch tone.
This message is ignored when "Receive Channel pressure" of the System common is OFF.

• Pitch bend change

Status	Second	Third
CnH	llH	mmH

n = MIDI channel number: 0H — FH (ch.1 — ch.16)
mm, ll = value: 00H, 00H — 7FH, 7FH (-8192 — +8191)

This message is ignored when "Receive Pitch bend" of the system common is OFF.

MIDI IMPLEMENTATION

Channel Mode Message

• All Sound Off

Status	Second	Third
BnH	78H	00H

n = MIDI channel number: 0H — FH (ch.1 — ch.16)

When this message is received, all currently-sounding notes on this corresponding channel will be turned off immediately.

This message is ignored when the "MIDI receive switch" is OFF for each part.

• Reset All Controllers

Status	Second	Third
BnH	79H	00H

n = MIDI channel number: 0H — FH (ch.1 — ch.16)

If this message is received, the values of following controllers will be changed.

Controller	Value
Modulation	0 (off)
Volume	127 (maximum)
Panpot	64 (center)
Expression	0 (off)
Hold 1	0 (off)
Channel pressure	0 (off)
Pitch bend change	0 (center)
RPN	No specified parameter, no value is changed.
NRPN	No specified parameter, no value is changed.

• All note off

Status	Second	Third
BnH	78H	00H

n = MIDI channel number: 0H — FH (ch.1 — ch.16)

When this message is recognized, all the note which have been turned on by "MIDI note on" message are turned off. However if Hold 1 or Sostenuato is on, the sound will be continued until these are turned off.

• OMNI Off

Status	Second	Third
BnH	7CH	00H

n = MIDI channel number: 0H — FH (ch.1 — ch.16)

Recognized as "All note off".

• OMNI On

Status	Second	Third
BnH	7DH	00H

n = MIDI channel number: 0H — FH (ch.1 — ch.16)

This message is recognized as "All note off". (Sound Expansion Series doesn't recognize OMNI on.)

• MONO

Status	Second	Third
BnH	7EH	mmH

n = MIDI channel number: 0H — FH (ch.1 — ch.16)

mm = number of mono: 00H — 10H (0 — 16)

"Assign mode" of patch common is Switched to "SOLO."

Recognize as "All notes off", and sets each patch MODE4 (M = 1).

• POLY

Status	Second	Third
BnH	7FH	00H

n = MIDI channel number :0H — FH (ch.1 — ch.16)

Switched over "Assign mode" of patch common.

Recognized all notes off, and set MODE3 at each patch.

System Realtime message

• Active sensing

Status
FEH

When Sound Expansion Series receives an "Active sensing," it measures time intervals between incoming messages. If the subsequent message does not come within 350 ms after the previous one, Sound Expansion Series will turn off all MIDI-on notes as if it received "Reset all controllers," stop measuring message interval.

• System Exclusive message

status	data bytes
F0H	iiH, ddH, ..., eeH
F7H	

F0H System exclusive

ii = manufacturer ID :41H (65)

dd, ..., ee = data: 00H — 7FH (0 — 127)

F7H: EOX (End of Exclusive/System common)

System exclusive message is ignored when "Receive Exclusive" of the system common is OFF.

Refer to section 3.4

System Exclusive Message for setting the Modes

"Data set 1 (DT1)", the Roland's Exclusive Format, is used for "GS reset" and "Exit GS Mode." The "Universal non-realtime message" format is used for "General MIDI system on" and "General MIDI system off."

• General MIDI system on

This model will be in an operational mode of "Patch Table 2" when receiving this message.

Status	Data byte	Status
F0H	7EH, 7FH, 09H, 01H	F7H

Byte	Description
F0H	Exclusive status
7EH	ID number (Universal Non-realtime Message)
7FH	Device ID (Broadcast)
09H	Sub ID#1 (General MIDI Message)
01H	Sub ID#2 (General MIDI On)
F7H	EOX (End Of Exclusive)

When this message is received, Rx.BANK SELECT will be OFF and Rx.NRPN will be OFF.

This message will not be received when "Exclusive" parameter of "MIDI Rx Sw" group = OFF.

Make an interval of 50ms or more, before receiving the next message.

• General MIDI system off

This model will be in an operational mode of "Patch Table 1" when receiving this message.

Status	Data byte	Status
F0H	7EH, 7FH, 09H, 02H	F7H

Byte	Description
F0H	Exclusive status
7EH	ID number (Universal Non-realtime Message)
7FH	Device ID (Broadcast)
09H	Sub ID#1 (General MIDI Message)
02H	Sub ID#2 (General MIDI On)
F7H	EOX (End Of Exclusive)

This message will not be received when "SysEx" parameter of "MIDI Rx Sw" group = OFF.

Make an interval of 50ms or more, before receiving the next message.

• GS reset

This model will be in an operational mode of "Patch Table 2" when receiving this message.

Status	Data byte	Status
F0H	41H, dev, 42H, 12H, 40H, 00H, 7FH, 00H, 41H	F7H

Byte	Description
F0H	Exclusive status
41H	ID number (Roland)
dev	Device ID (dev: 00H — 1FH (1 — 32), Initial value is 10H (17))
42H	Model ID (GS)
12H	Command ID (DT1)
40H	address MSB
00H	address
7FH	address LSB
00H	data (GS reset)
41H	Check sum
F7H	EOX (End Of Exclusive)

When this message is received, Rx.NRPN will set ON.
 This message will not be received when "SysEx" parameter of "MIDI Rx Sw" group = OFF.
 Make an interval of 50ms or more, before receiving the next message.

• Exit GS mode

This model will be in an operational mode of "Patch Table 1" when receiving this message.

Status	Data byte	Status
FOH	41H, dev, 42H, 12H, 40H, 00H, 7FH, 7FH, 42H	F7H

Byte	Description
FOH	Exclusive status
41H	ID number (Roland)
dev	Device ID (dev: 00H — 1FH (1 — 32), Initial value is 10H (17))
42H	Model ID (GS)
12H	Command ID (DT1)
40H	Address MSB
00H	Address
7FH	Address LSB
7FH	Data (Exit GS mode)
42H	Check sum
F7H	EOX (End Of Exclusive)

This message will not be received when "Exclusive" parameter of "MIDI Rx Sw" group = OFF.
 Make an interval of 50ms or more, before receiving the next message.

2. TRANSMIT DATA

System realtime

• Active sensing

status
FEH

This message is transmitted with 250 milli seconds interval.

• System exclusive message

status	data bytes
FOH	iiH, ddH, ..., eeH
F7H	

FOH: System exclusive
 ii = manufacturer ID: 41H (65)
 dd, ..., ee = Data: 00H — 7FH (0 — 127)
 F7H: EOX (End of Exclusive/System common)

Refer to section 3.4.

3. Exclusive communications

The Sound Expansion Series can send and receive patch parameter, etc using the system exclusive message.
 The model ID code of the Sound Expansion Series is 46H. The device ID code is to be determined by the "Device ID" setting of Master.

The Sound Expansion Series ignores GS exclusive message other than "GS reset," "Exit GS mode" and "Scale tune parameter," General MIDI system on, General MIDI system off, GS reset and Exit GS.
 The model ID of the GS is 42H.

One way communication.

• Request data 1 RQ1 (11H)

Bytes	Description
FOH	Exclusive status
41H	Manufacturer ID (Roland)
Dev	Device ID
46H	Model ID (Sound Expansion Series)
11H	Command ID (RQ 1)
aaH	Address MSB
bbH	Address
ccH	Address
ddH	Address LSB
ssH	Size MSB
ttH	Size
uuH	Size
vvH	Size LSB
sum	Check sum
F7H	EOX (End of exclusive)

Receive only: the Sound Expansion Series does not send this message.

Data set 1 DT1 (12H)

• 1. Sound Expansion Series (MODEL ID = 46H)

Bytes	Description
FOH	Exclusive status
41H	Manufacturer ID (Roland)
Dev	Device ID
46H	Model ID
12H	Command ID (DT 1)
aaH	Address MSB
bbH	Address
ccH	Address
ddH	Address LSB
eeH	Data
:	:
ffH	Data
sum	Check sum
F7H	EOX (End of exclusive)

2. GS (MODEL ID = 42H)

Bytes	Description
FOH	Exclusive status
41H	Manufacturer ID (Roland)
Dev	Device ID
42H	Model ID (GS)
12H	Command ID (DT1)
aaH	Address MSB
bbH	Address
ccH	Address
eeH	Data
:	:
ffH	Data
sum	Check sum
F7H	EOX (End of Exclusive)

Note: When the device ID is 7FH, Sound Expansion Series can receive the exclusive message even if the unit number is anything.

• Parameter address map

Address and size are configured in 7 bits, hexadecimal notation.

Address	MSB	LSB
Binary	0aaa 0aaa	0bbb 0bbb 0ccc 0ccc 0ddd 0ddd
7-bits hex	AA	BB CC DD

Size	MSB	LSB
Binary	0sss 0sss	0ttt 0ttt 0uuu 0uuu 0vvv 0vvv
7-bits hex	SS	TT UU VV

• Parameter base address

- 1) A pair of two addresses preceded by the symbol # represents a divided — by -two data. e.g. the data ABH (hex) is divided into 0AH and 0BH and sent in that order.
- 2) Parameter associated with address following the symbol % are for Sound Expansion Series

• Example of exclusive data

Data Set 1 (1 byte data)
 To Select Pan-Delay for the Reverb Type.
 FO 41 10 46 12 00 00 10 0D 07 5C F7

Note that the 5th byte value is 12H in order to "Set" the data.
 Send the data (07 for Pan-Delay) with the address (00 00 01 0D for reverb type) of the "Performance common" parameter.

Data set 1 (2 byte data)
 To Select Wave Number 141 for Patch Tone 1 in Part 1.
 FO 41 10 46 12 00 00 28 01 08 0C 43 F7

The Address for Patch Tone 1 in Part 1 is 00 00 28 01.
 If you want to send 140 as a data, first you need to change it to hex-decimal notation which is 8C.
 Then divide this in 2 byte, which is called "mblitzing", and send 08 0C as data.

Request Data
 Make the module to send the chorus level.
 FO 41 10 46 11 00 00 10 12 00 00 00 01 5D F7

Note that the 5th byte value is 11H, in order to "Request" the data.
 Send 00 00 10 12 as an Address for Chorus Level and 00 00 00 01 as "Size of the data" for it, which is 1 byte.
 When the module receives this data, it will automatically send back the following data from MIDI OUT.
 FO 41 10 46 12 00 00 10 12 3C 22 F7

MIDI IMPLEMENTATION

You will notice that the Chorus Level is 3C (60).

Check sum

The error checking process uses a checksum and provides a bit pattern where the last significant 7 bits are zero, when values for an address, data (or size) and the checksum are summed.

< Example >

F0 41 10 46 12 00 00 10 0D 06 5D F7

$[80H - ((00H + 00H + 10H + 0DH + 06H) \& 7FH)] \& 7F = 5DH$
 Address data

1. Sound Expansion Series <MODEL ID = 46H>

* 1 - 1 System Common

Address	Description	
00 00 00 00	0000 000a	0 — 1 (PERFORMANCE, PATCH)
00 00 00 01	000a 000a	Master tune 1 — 127 (427.4 — 452.6)
%00 00 00 02	000a 000a	Key transpose 28 — 100
%00 00 00 03	0000 000a	Transpose Switch 0 — 1
00 00 00 04	0000 000a	Reverb switch 0 — 1 (OFF, ON)
00 00 00 05	0000 000a	Chorus switch 0 — 1 (OFF, ON)
%00 00 00 06	0000 000a	Hold polarity 0 — 1
%00 00 00 07	0000 000a	Pedal 1 polarity 0 — 1
%00 00 00 08	0000 000a	Pedal 1 mode 0 — 3
%00 00 00 09	000a 000a	Pedal 1 assign 0 — 100
%00 00 00 0A	0000 000a	Pedal 2 polarity 0 — 1
%00 00 00 0B	0000 000a	Pedal 2 mode 0 — 3
%00 00 00 0C	000a 000a	Pedal 2 assign 0 — 100
%00 00 00 0D	0000 000a	CI mode 0 — 3
%00 00 00 0E	000a 000a	CI assign 0 — 100
%00 00 00 0F	000a 000a	Aftertouch threshold 0 — 127
MIDI receive switch		
00 00 00 10	0000 000a	Volume 0 — 1 (OFF, ON)
00 00 00 11	0000 000a	Control change 0 — 1 (OFF, ON)
00 00 00 12	0000 000a	Channel pressure 0 — 1 (OFF, ON)
00 00 00 13	0000 000a	Modulation 0 — 1 (OFF, ON)
00 00 00 14	0000 000a	Pitch bend 0 — 1 (OFF, ON)
00 00 00 15	0000 000a	Program change 0 — 1 (OFF, ON)
00 00 00 16	0000 000a	Bank select 0 — 1 (OFF, ON)
MIDI transmit switch		
%00 00 00 17	0000 000a	Volume 0 — 1
%00 00 00 18	0000 000a	Control change 0 — 1
%00 00 00 19	0000 000a	Channel pressure 0 — 1
%00 00 00 1A	0000 000a	Modulation 0 — 1
%00 00 00 1B	0000 000a	Bender 0 — 1
%00 00 00 1C	0000 000a	Program change 0 — 1
%00 00 00 1D	0000 000a	Bank select 0 — 1
00 00 00 1E	0000 000a	Patch receive channel 0 — 15 (1 — 16)
%00 00 00 1F	000a 000a	Patch transmit channel 0 — 17
00 00 00 20	000a 000a	Control channel 0 — 16 (1 — 16, OFF)
%00 00 00 21	0000 000a	Output mode 0 — 1 (OUT2, OUT4)
%00 00 00 22	0000 000a	Rhythm edit key 0 — 1 (INT&MIDI, INT)
00 00 00 23	0000 000a	Scale tune switch 0 — 1 (OFF, ON)
00 00 00 24	000a 000a	Scale Tune Part1 C 0 — 127 (–64 — +63)
00 00 00 25	:	C#
00 00 00 26	:	D
00 00 00 27	:	D#
00 00 00 28	:	E
00 00 00 29	:	F
00 00 00 2A	:	F#
00 00 00 2B	:	G
00 00 00 2C	:	G#
00 00 00 2D	:	A
00 00 00 2E	:	A#
00 00 00 2F	:	B
00 00 00 30	000a 000a	Scale Tune Part2 C 0 — 127 (–64 — +63)
00 00 00 31	:	:
00 00 00 32	:	B
00 00 00 33	000a 000a	Scale Tune Part3 C 0 — 127 (–64 — +63)
00 00 00 34	:	:
00 00 00 35	:	B

00 00 00 48	000a 000a	Scale Tune Part4 C 0 — 127 (–64 — +63)
00 00 00 49	:	:
00 00 00 50	:	B
00 00 00 51	:	:
00 00 00 52	:	:
00 00 00 53	:	B
00 00 00 54	000a 000a	Scale Tune Part5 C 0 — 127 (–64 — +63)
00 00 00 55	:	:
00 00 00 56	:	B
00 00 00 57	:	:
00 00 00 58	:	:
00 00 00 59	:	B
00 00 00 60	000a 000a	Scale Tune Part6 C 0 — 127 (–64 — +63)
00 00 00 61	:	:
00 00 00 62	:	B
00 00 00 63	000a 000a	Scale Tune Part7 C 0 — 127 (–64 — +63)
00 00 00 64	:	:
00 00 00 65	:	B
00 00 00 66	:	:
00 00 00 67	:	B
00 00 00 68	:	:
00 00 00 69	:	B
00 00 00 70	000a 000a	Scale Tune Part8 C 0 — 127 (–64 — +63)
00 00 00 71	:	:
00 00 00 72	:	B
00 00 00 73	:	:
00 00 00 74	:	B
00 00 00 75	:	:
00 00 00 76	:	B
00 00 00 77	:	:
00 00 00 78	000a 000a	Scale Tune Part8 C 0 — 127 (–64 — +63)
00 00 00 79	:	:
00 00 00 80	:	B
00 00 00 81	:	:
00 00 00 82	:	B
00 00 00 83	:	:
00 00 00 84	000a 000a	Scale Tune Patch C 0 — 127 (–64 — +63)
00 00 00 85	:	:
00 00 00 86	:	B
00 00 00 87	0 — —	(Dummy)
00 00 00 88	:	:
00 00 00 89	:	B
00 00 00 90	:	:
00 00 00 91	0 — —	(Dummy)
00 00 00 92	:	:
00 00 00 93	:	B
00 00 00 94	:	:
00 00 00 95	:	B
00 00 00 96	:	:
00 00 00 97	:	B
00 00 00 98	:	:
00 00 00 99	:	B
00 00 00 100	:	:
00 00 00 101	:	B
00 00 00 102	:	:
00 00 00 103	:	B
00 00 00 104	:	:
00 00 00 105	:	B
00 00 00 106	:	:
00 00 00 107	:	B
00 00 00 108	:	:
00 00 00 109	:	B
00 00 00 110	:	:
00 00 00 111	000a 000a	Master volume 0 — 127
Total Size	00 00 01 12	

1-2 Performance

1-2-1 Performance Common

Address	Description	
00 00 10 00	000a 000a	Performance name 1 32 — 127
00 00 10 01	000a 000a	Performance name 2 32 — 127
00 00 10 08	000a 000a	Performance name 12 32 — 127
00 00 10 0D	0000 000a	Reverb type 0 — 7
(ROOM1, ROOM2, STAGE1, STAGE2, HALL1, HALL2, DELAY, PAN-DLY)		
00 00 10 0E	000a 000a	Reverb level 0 — 127
00 00 10 0F	000a 000a	Reverb time 0 — 127
00 00 10 10	000a 000a	Reverb feedback 0 — 127
00 00 10 11	0000 000a	Chorus type 0 — 2 (CHORUS1, CHORUS2, CHORUS3)
00 00 10 12	000a 000a	Chorus level 0 — 127
00 00 10 13	000a 000a	Chorus depth 0 — 127
00 00 10 14	000a 000a	Chorus rate 0 — 127
00 00 10 15	000a 000a	Chorus feedback 0 — 127
00 00 10 16	0000 000a	Chorus output 0 — 1 (OUTPUT, REV)
If this parameter set to "OUTPUT," chorus signal send to "Output."		
If this parameter set to "REV," chorus signal send to reverb.		
00 00 10 17	000a 000a	Part 1 Voice assign 0 — 28
00 00 10 18	000a 000a	Part 2 Voice assign 0 — 28
00 00 10 1E	000a 000a	Part 8 Voice assign 0 — 28
Total Size	00 00 00 1F	

Note: The sum of Voice reserves must be less than or equal to 28

1-2-2 Performance Part

00 00 1x dd
 x = 08H — 0FH (Part1 — part8), dd = Description

Address	Description	
%00 00 1x 00	0000 000a	Transmit switch 0 — 1
%00 00 1x 01	0000 000a	Transmit channel 0 — 15
%00 00 1x 02	0000 000a	Transmit program change 0 — 128
%00 00 1x 04	0000 000a	Transmit volume 0 — 128
%00 00 1x 06	0000 000a	Transmit pan 0 — 128
%00 00 1x 08	0000 000a	Transmit key range lower 0 — 127
%00 00 1x 09	000a 000a	Transmit key range upper 0 — 127
%00 00 1x 0A	000a 000a	Transmit key transpose 28 — 100
%00 00 1x 0B	000a 000a	Transmit velocity sense 1 — 127
%00 00 1x 0C	000a 000a	Transmit velocity max 0 — 127
%00 00 1x 0D	0000 000a	Transmit velocity curve 0 — 6
%00 00 1x 0E	0000 000a	Internal switch 0 — 1
%00 00 1x 0F	000a 000a	Internal key range lower 0 — 127
%00 00 1x 10	000a 000a	Internal key range upper 0 — 127
%00 00 1x 11	000a 000a	Internal key transpose 28 — 100
%00 00 1x 12	000a 000a	Internal velocity sense 1 — 127
%00 00 1x 13	000a 000a	Internal velocity max 0 — 127

MIDI IMPLEMENTATION

%00 00 1x 14	0000 0000	Internal velocity curve	0 — 6
00 00 1x 15	0000 000a	Receive switch	0 — 1 (OFF, ON)
00 00 1x 16	0000 000a	Receive channel	0 — 15 (1 — 16)
#00 00 1x 17	0000 000a 0000 bbbb	Patch number	0 — 254
00 00 1x 19	000a 000a	Part level	0 — 127
00 00 1x 1A	000a 000a	Part pan	0 — 127 (L64 — 63R)
00 00 1x 1B	000a 000a	Part coarse tune	16 — 112 (-48 — +48)
00 00 1x 1C	000a 000a	Part fine tune	14 — 114 (-50 — +50)
00 00 1x 1D	0000 000a	Reverb switch	0 — 1 (OFF, ON)
00 00 1x 1E	0000 000a	Chorus switch	0 — 1 (OFF, ON)
00 00 1x 1F	0000 000a	Receive program change	0 — 1 (OFF, ON)
00 00 1x 20	0000 000a	Receive volume	0 — 1 (OFF, ON)
00 00 1x 21	0000 000a	Receive hold-1	0 — 1 (OFF, ON)
%00 00 1x 22	0000 000a	Output select	0 — 2 (M1, S8, PAT)
%00 00 1x 23	0000 000a	Patch media	2 (EXP)
%00 00 1x 24	0000 000a	Sequencer switch	0 — 1 (ON, OFF)
Total Size	00 00 00 25		

Note: The value of the Transmit key range upper must be greater than or equal to the Transmit key range lower.
 Note: The value of the Internal key range upper must be greater than or equal to the Internal key range lower.

* 1-3 Patch

00 0s 2y dd
 0s = 00H — 06H (Performance Mode Temporary patch)
 08H (Patch Mode Temporary patch)
 dd = Description

* 1-3-1 Patch Common

Address	Description
00 0s 20 00	000a 000a Patch name 1 32 — 127
00 0s 20 01	000a 000a Patch name 2 32 — 127
00 0s 20 08	000a 000a Patch name 12 32 — 127
00 0s 20 0C	0000 000a Velocity switch 0 — 1 (OFF, ON)
00 0s 20 0D	0000 000a Reverb type 0 — 7 (ROOM1, ROOM2, STAGE1, STAGE2, HALL1, HALL2, DELAY, PAN-DLY)
00 0s 20 0E	000a 000a Reverb level 0 — 127
00 0s 20 0F	000a 000a Reverb time 0 — 127
00 0s 20 10	000a 000a Delay feedback 0 — 127
00 0s 20 11	0000 000a Chorus type 0 — 2 (CHORUS1, CHORUS2, CHORUS3)
00 0s 20 12	000a 000a Chorus level 0 — 127
00 0s 20 13	000a 000a Chorus depth 0 — 127
00 0s 20 14	000a 000a Chorus rate 0 — 127
00 0s 20 15	000a 000a Chorus feedback 0 — 127
00 0s 20 16	0000 000a Chorus output 0 — 1 (OUTPUT, REV) If this parameter set to "OUTPUT," chorus signal send to "Output." If this parameter set to "REV," chorus signal send to reverb.
00 0s 20 17	000a 000a Analog feel 0 — 127
00 0s 20 18	000a 000a Patch level 0 — 127
00 0s 20 19	000a 000a Patch pan 0 — 127 (L64 — 63R)
00 0s 20 1A	000a 000a Bender range down 16 — 64 (-48 — 0)
00 0s 20 1B	0000 000a Bender range up 0 — 12
00 0s 20 1C	0000 000a Key assign 0 — 1 (POLY, SLD)
00 0s 20 1D	0000 000a Solo legato 0 — 1 (OFF, ON)
00 0s 20 1E	0000 000a Portamento switch 0 — 1 (OFF, ON)
00 0s 20 1F	0000 000a Portamento mode 0 — 1 (LEGATO, NORMAL)
00 0s 20 20	0000 000a Portamento type 0 — 1 (TIME, RATE)
00 0s 20 21	000a 000a Portamento time 0 — 127
Total Size	00 00 00 22

* 1-3-2 Patch Tone

y = 08H — 0BH (Patch Tone 1 — Patch Tone 4)

Address	Description
%00 0s 2y 00	0000 000a Wave group 1 (EXP)
#00 0s 2y 01	0000 000a Wave number 0 — 254 (1 — 255)
00 0s 2y 03	0000 000a Tone switch 0 — 1 (OFF, ON)
00 0s 2y 04	0000 000a FXM switch 0 — 1 (OFF, ON)
00 0s 2y 05	0000 000a FXM depth 0 — 15 (1 — 16)
00 0s 2y 06	000a 000a Velocity range lower 0 — 127
00 0s 2y 07	000a 000a Velocity range upper 0 — 127 (Turn "On" the Velocity switch of the Patch common parameters to make "Velocity Range" work.)
00 0s 2y 08	0000 000a Volume switch 0 — 1 (OFF, ON)
00 0s 2y 09	0000 000a Hold-1 switch 0 — 1 (OFF, ON)
00 0s 2y 0A	0000 000a Modulation 1 destination 0 — 12 (*1)
00 0s 2y 0B	000a 000a Modulation 1 depth 1 — 127 (-63 — +63)
00 0s 2y 0C	0000 000a Modulation 2 destination 0 — 12 (*1)
00 0s 2y 0D	000a 000a Modulation 2 depth 1 — 127 (-63 — +63)

00 0s 2y 0E	0000 000a Modulation 3 destination 0 — 12 (*1)
00 0s 2y 0F	000a 000a Modulation 3 depth 1 — 127 (-63 — +63)
00 0s 2y 10	0000 000a Modulation 4 destination 0 — 12 (*1)
00 0s 2y 11	000a 000a Modulation 4 depth 1 — 127 (-63 — +63)
00 0s 2y 12	0000 000a Aftertouch 1 destination 0 — 12 (*1)
00 0s 2y 13	000a 000a Aftertouch 1 depth 1 — 127 (-63 — +63)
00 0s 2y 14	0000 000a Aftertouch 2 destination 0 — 12 (*1)
00 0s 2y 15	000a 000a Aftertouch 2 depth 1 — 127 (-63 — +63)
00 0s 2y 16	0000 000a Aftertouch 3 destination 0 — 12 (*1)
00 0s 2y 17	000a 000a Aftertouch 3 depth 1 — 127 (-63 — +63)
00 0s 2y 18	0000 000a Aftertouch 4 destination 0 — 12 (*1)
00 0s 2y 19	000a 000a Aftertouch 4 depth 1 — 127 (-63 — +63)
00 0s 2y 1A	0000 000a Expression 1 destination 0 — 12 (*1)
00 0s 2y 1B	000a 000a Expression 1 depth 1 — 127 (-63 — +63)
00 0s 2y 1C	0000 000a Expression 2 destination 0 — 12 (*1)
00 0s 2y 1D	000a 000a Expression 2 depth 1 — 127 (-63 — +63)
00 0s 2y 1E	0000 000a Expression 3 destination 0 — 12 (*1)
00 0s 2y 1F	000a 000a Expression 3 depth 1 — 127 (-63 — +63)
00 0s 2y 20	0000 000a Expression 4 destination 0 — 12 (*1)
00 0s 2y 21	000a 000a Expression 4 depth 1 — 127 (-63 — +63)

(*1) 0 to 12 of (!) refer to the followings
 (OFF, PITCH, CUTOFF, RESONANCE, LEVEL, PITCH LFO1, PITCH LFO2, TVF LFO1, TVF LFO2, TVA LFO1, TVA LFO2, LFO1 RATE, LFO2 RATE)

00 0s 2y 22	0000 000a LFO-1 form 0 — 5 (TRI, SIN, SAW, SQR, RND1, RND2)
00 0s 2y 23	0000 000a LFO-1 offset 0 — 4 (-00, -50, 0, +50, +100)
00 0s 2y 24	0000 000a LFO-1 synchro 0 — 1 (OFF, ON)
00 0s 2y 25	000a 000a LFO-1 rate 0 — 127
#00 0s 2y 26	0000 000a LFO-1 delay 0 — 128 (0 — 127, KEY-OFF)
00 0s 2y 28	0000 000a LFO-1 fade polarity 0 — 1 (IN, OUT)
00 0s 2y 29	000a 000a LFO-1 fade time 0 — 127
00 0s 2y 2A	000a 000a LFO-1 pitch depth 1 — 127 (-63 — +63)
00 0s 2y 2B	000a 000a LFO-1 TVF depth 1 — 127 (-63 — +63)
00 0s 2y 2C	000a 000a LFO-1 TVA depth 1 — 127 (-63 — +63)
00 0s 2y 2D	0000 000a LFO-2 form 0 — 5 (TRI, SIN, SAW, SQR, RND1, RND2)
00 0s 2y 2E	0000 000a LFO-2 offset 0 — 4 (-100, -50, 0, +50, +100)
00 0s 2y 2F	0000 000a LFO-2 synchro 0 — 1 (OFF, ON)
00 0s 2y 30	000a 000a LFO-2 rate 0 — 127
#00 0s 2y 31	0000 000a LFO-2 delay 0 — 128 (0 — 127, KEY-OFF)
00 0s 2y 33	0000 000a LFO-2 fade polarity 0 — 1 (IN, OUT)
00 0s 2y 34	000a 000a LFO-2 fade time 0 — 127
00 0s 2y 35	000a 000a LFO-2 pitch depth 1 — 127 (-63 — +63)
00 0s 2y 36	000a 000a LFO-2 TVF depth 1 — 127 (-63 — +63)
00 0s 2y 37	000a 000a LFO-2 TVA depth 1 — 127 (-63 — +63)
00 0s 2y 38	000a 000a Pitch coarse 16 — 112 (-48 — +48)
00 0s 2y 39	000a 000a Pitch fine 14 — 114 (-50 — +50)
00 0s 2y 3A	0000 000a Random pitch 0 — 15 (0, 5, 10, 20, 30, 40, 50, 70, 100, 200, 300, 400, 500, 600, 800, 1200)
00 0s 2y 3B	0000 000a Pitch key follow 0 — 15 (-100, -70, -50, -30, -10, 0, +10, +20, +30, +40, +50, +70, +100, +120, +150, +200)
00 0s 2y 3C	000a 000a P-ENV velocity sense 1 — 127 (-63 — +63)
00 0s 2y 3D	0000 000a P-ENV T1 velocity 0 — 14 (-100, -70, -50, -40, -30, -20, -10, 0, +10, +20, +30, +40, +50, +70, +100)
00 0s 2y 3E	0000 000a P-ENV T4 velocity 0 — 14 (-100, -70, -50, -40, -30, -20, -10, 0, +10, +20, +30, +40, +50, +70, +100)
00 0s 2y 3F	0000 000a P-ENV time key follow 0 — 14 (-100, -70, -50, -40, -30, -20, -10, 0, +10, +20, +30, +40, +50, +70, +100)
00 0s 2y 40	000a 000a P-ENV depth 52 — 76 (-12 — +12)
00 0s 2y 41	000a 000a P-ENV time 1 0 — 127
00 0s 2y 42	000a 000a P-ENV level 1 1 — 127 (-63 — +63)
00 0s 2y 43	000a 000a P-ENV time 2 0 — 127
00 0s 2y 44	000a 000a P-ENV level 2 1 — 127 (-63 — +63)
00 0s 2y 45	000a 000a P-ENV time 3 0 — 127
00 0s 2y 46	000a 000a P-ENV level 3 1 — 127 (-63 — +63)
00 0s 2y 47	000a 000a P-ENV time 4 0 — 127
00 0s 2y 48	000a 000a P-ENV level 4 1 — 127 (-63 — +63)
00 0s 2y 49	0000 000a TVF mode 0 — 2 (OFF, LPF, HPF)
00 0s 2y 4A	000a 000a Cutoff frequency 0 — 127
00 0s 2y 4B	000a 000a Resonance 0 — 127
00 0s 2y 4C	0000 000a Resonance mode 0 — 1 (SOFT, HARD)
00 0s 2y 4D	0000 000a TVF key follow 0 — 15 (-100, -70, -50, -30, -10, 0, +10, +20, +30, +40, +50, +70, +100, +120, +150, +200)
00 0s 2y 4E	0000 000a TVF-ENV velocity curve 0 — 6 (1 — 7)
00 0s 2y 4F	000a 000a TVF-ENV velocity sense 1 — 127 (-63 — +63)
00 0s 2y 50	0000 000a TVF-ENV T1 velocity 0 — 14 (-100, -70, -50, -40, -30, -20, -10, 0, +10, +20, +30, +40, +50, +70, +100)
00 0s 2y 51	0000 000a TVF-ENV T4 velocity 0 — 14 (-100, -70, -50, -40, -30, -20, -10, 0, +10, +20, +30, +40, +50, +70, +100)

MIDI IMPLEMENTATION

00 0s 2y 52	0000 0000	TVF-ENV time key follow	0 — 14 (-100, -70, -50, -40, -30, -20, -10, 0, +10, +20, +30, +40, +50, +70, +100)
00 0s 2y 53	0000 0000	TVF-ENV depth	1 — 127 (-63 — +63)
00 0s 2y 54	0000 0000	TVF-ENV time 1	0 — 127
00 0s 2y 55	0000 0000	TVF-ENV level 1	0 — 127
00 0s 2y 56	0000 0000	TVF-ENV time 2	0 — 127
00 0s 2y 57	0000 0000	TVF-ENV level 2	0 — 127
00 0s 2y 58	0000 0000	TVF-ENV time 3	0 — 127
00 0s 2y 59	0000 0000	TVF-ENV level 3	0 — 127
00 0s 2y 5A	0000 0000	TVF-ENV time 4	0 — 127
00 0s 2y 5B	0000 0000	TVF-ENV level 4	0 — 127
00 0s 2y 5C	0000 0000	Level	0 — 127
00 0s 2y 5D	0000 0000	TVA key follow	0 — 14 (-100, -70, -50, -40, -30, -20, -10, 0, +10, +20, +30, +40, +50, +70, +100)
#00 0s 2y 5E	0000 0000	Pan	0 — 128 (L64 — 63R, RND)
00 0s 2y 60	0000 0000	Panning key follow	0 — 14 (-100, -70, -50, -40, -30, -20, -10, 0, +10, +20, +30, +40, +50, +70, +100)
00 0s 2y 61	0000 0000	TVA delay mode	0 — 2 (NORMAL, HOLD, PLAY-MATE)
#00 0s 2y 62	0000 0000	TVA delay time	0 — 128 (0 — 127, KEY-OFF)
00 0s 2y 64	0000 0000	TVA-ENV velocity curve	0 — 6 (1 — 7)
00 0s 2y 65	0000 0000	TVA-ENV velocity sense	1 — 127 (-63 — +63)
00 0s 2y 66	0000 0000	TVA-ENV T1 velocity	0 — 14 (-100, -70, -50, -40, -30, -20, -10, 0, +10, +20, +30, +40, +50, +70, +100)
00 0s 2y 67	0000 0000	TVA-ENV T4 velocity	0 — 14 (-100, -70, -50, -40, -30, -20, -10, 0, +10, +20, +30, +40, +50, +70, +100)
00 0s 2y 68	0000 0000	TVA-ENV time key follow	0 — 14 (-100, -70, -50, -40, -30, -20, -10, 0, +10, +20, +30, +40, +50, +70, +100)
00 0s 2y 69	0000 0000	TVA-ENV time 1	0 — 127
00 0s 2y 6A	0000 0000	TVA-ENV level 1	0 — 127
00 0s 2y 6B	0000 0000	TVA-ENV time 2	0 — 127
00 0s 2y 6C	0000 0000	TVA-ENV level 2	0 — 127
00 0s 2y 6D	0000 0000	TVA-ENV time 3	0 — 127
00 0s 2y 6E	0000 0000	TVA-ENV level 3	0 — 127
00 0s 2y 6F	0000 0000	TVA-ENV time 4	0 — 127
00 0s 2y 70	0000 0000	Dry level	0 — 127
00 0s 2y 71	0000 0000	Reverb send level	0 — 127
00 0s 2y 72	0000 0000	Chorus send level	0 — 127
%00 0s 2y 73	0000 0000	Output select	0 — 1 (MAIN, SUB)
00 0s 2y 74	0000 0000	Redampers switch	0 — 1 (OFF, ON)
Total Size	00 00 00 75		

The values of the Velocity Range Upper must be greater than or equal to the values of Velocity Range Lower.

* 1-4 Rhythm Setup 1

00 mm rr cc
mm = 07
rr = 40H — 7CH (Note #36 — Note #96)
cc = Description

* 1-4-1 Rhythm Note 1

Address	Description
00 mm rr 00	0000 0000 Wave group 1 (EXP)
#00 mm rr 01	0000 0000 Wave number 0 — 254
0000 bbbb	(1 — 255)
00 mm rr 03	0000 0000 Tone switch 0 — 1 (OFF, ON)
00 mm rr 04	0000 0000 Coarse tune 0 — 127 (C-1 — G9)
00 mm rr 05	0000 0000 Mute group 0 — 31 (OFF, 1 — 31)
00 mm rr 06	0000 0000 Envelope mode 0 — 1 (NO-SUSTAIN, SUSTAIN)
00 mm rr 07	0000 0000 Pitch fine 14 — 114 (-50 — +50)
00 mm rr 08	0000 0000 Random pitch 0 — 15 (0, 5, 10, 20, 30, 40, 50, 70, 100, 200, 300, 400, 500, 600, 800, 1200)
00 mm rr 09	0000 0000 Bender range 0 — 12
00 mm rr 0A	0000 0000 P-ENV velocity sense 1 — 127 (-63 — +63)
00 mm rr 0B	0000 0000 P-ENV time velocity sense 0 — 14 (-100, -70, -50, -40, -30, -20, -10, 0, +10, +20, +30, +40, +50, +70, +100)
00 mm rr 0C	0000 0000 P-ENV depth 52 — 76 (-12 — +12)
00 mm rr 0D	0000 0000 P-ENV time 1 0 — 127
00 mm rr 0E	0000 0000 P-ENV level 1 1 — 127 (-63 — +63)
00 mm rr 0F	0000 0000 P-ENV time 2 0 — 127
00 mm rr 10	0000 0000 P-ENV level 2 1 — 127 (-63 — +63)
00 mm rr 11	0000 0000 P-ENV time 3 0 — 127
00 mm rr 12	0000 0000 P-ENV level 3 1 — 127 (-63 — +63)
00 mm rr 13	0000 0000 P-ENV time 4 0 — 127
00 mm rr 14	0000 0000 P-ENV level 4 1 — 127 (-63 — +63)
00 mm rr 15	0000 0000 TVF mode 0 — 2 (OFF, LPF, HPF)
00 mm rr 16	0000 0000 Cutoff frequency 0 — 127
00 mm rr 17	0000 0000 Resonance 0 — 127

00 mm rr 18	0000 0000	Resonance mode	0 — 1 (SOFT, HARD)
00 mm rr 19	0000 0000	TVF-ENV velocity sense	1 — 127 (-63 — +63)
00 mm rr 1A	0000 0000	TVF-ENV time velocity sense	0 — 14 (-100, -70, -50, -40, -30, -20, -10, 0, +10, +20, +30, +40, +50, +70, +100)
00 mm rr 1B	0000 0000	TVF-ENV depth	1 — 127 (-63 — +63)
00 mm rr 1C	0000 0000	TVF-ENV time 1	0 — 127
00 mm rr 1D	0000 0000	TVF-ENV level 1	0 — 127
00 mm rr 1E	0000 0000	TVF-ENV time 2	0 — 127
00 mm rr 1F	0000 0000	TVF-ENV level 2	0 — 127
00 mm rr 20	0000 0000	TVF-ENV time 3	0 — 127
00 mm rr 21	0000 0000	TVF-ENV level 3	0 — 127
00 mm rr 22	0000 0000	TVF-ENV time 4	0 — 127
00 mm rr 23	0000 0000	TVF-ENV level 4	0 — 127
00 mm rr 24	0000 0000	Level	0 — 127
#00 mm rr 25	0000 0000	Pan	0 — 128 (L64 — 63R, RND)
0000 bbbb	(L64 — 63R, RND)		
00 mm rr 27	0000 0000	TVA-ENV velocity sense	1 — 127 (-63 — +63)
00 mm rr 28	0000 0000	TVA-ENV time velocity sense	0 — 14 (-100, -70, -50, -40, -30, -20, -10, 0, +10, +20, +30, +40, +50, +70, +100)
00 mm rr 29	0000 0000	TVA-ENV time 1	0 — 127
00 mm rr 2A	0000 0000	TVA-ENV level 1	0 — 127
00 mm rr 2B	0000 0000	TVA-ENV time 2	0 — 127
00 mm rr 2C	0000 0000	TVA-ENV level 2	0 — 127
00 mm rr 2D	0000 0000	TVA-ENV time 3	0 — 127
00 mm rr 2E	0000 0000	TVA-ENV level 3	0 — 127
00 mm rr 2F	0000 0000	TVA-ENV time 4	0 — 127
00 mm rr 30	0000 0000	Dry level	0 — 127
00 mm rr 31	0000 0000	Reverb send level	0 — 127
00 mm rr 32	0000 0000	Chorus send level	0 — 127
%00 mm rr 33	0000 0000	Output select	0 — 1 (MAIN, SUB)
Total Size	00 00 00 34		

* 1-5 Rhythm Setup 2

00 mm rr cc
mm = 20
rr = 38H — 3FH (Note #28 — Note #35)
= 40H — 46H (Note #97 — Note #103)
cc = Description

* 1-5-1 Rhythm Note 2

Same as 1-4-1.

2 GS

< MODEL ID = 42H >

2-1 Scale Tune

w = 0 — 7 (Scale tune PartB, 1, 2, ..., 7)

Address	Description
40 1w 40	0000 0000 Scale Tune C 00 — 127 (-64 — +63)
40 1w 41	: : C#
40 1w 42	: : D
40 1w 43	: : D#
40 1w 44	: : E
40 1w 45	: : F
40 1w 46	: : F#
40 1w 47	: : G
40 1w 48	: : G#
40 1w 49	: : A
40 1w 4A	: : A#
40 1w 4B	: : B
Total Size	00 00 0C

Note: If you send the Scale Tune data, must send from "C" to "B" (1 oct) per packet.

/ Example of DT1 application /

To set the tune (C — B) of the performance part 1 Arabic, send the data as follow:
 FDH 41H 10H 42H 12H 40H 11H 40H 3AH 6DH 3EH 34H 0DH 38H 6BH 3CH 6FH 40H 36H 0FH 50H 7FH

Table A-1: Decimal to Hexadecimal

The MIDI message are expressed in hexadecimal configured in 7 bits.
 This table is useful when you read or write MIDI messages.

(D) = decimal
 (H) = Hexadecimal

(D)	(H)	(D)	(H)	(D)	(H)	(D)	(H)
0	00H	32	20H	64	40H	96	60H
1	01H	33	21H	65	41H	97	61H
2	02H	34	22H	66	42H	98	62H
3	03H	35	23H	67	43H	99	63H
4	04H	36	24H	68	44H	100	64H
5	05H	37	25H	69	45H	101	65H
6	06H	38	26H	70	46H	102	66H
7	07H	39	27H	71	47H	103	67H
8	08H	40	28H	72	48H	104	68H
9	09H	41	29H	73	49H	105	69H
10	0AH	42	2AH	74	4AH	106	6AH
11	0BH	43	2BH	75	4BH	107	6BH
12	0CH	44	2CH	76	4CH	108	6CH
13	0DH	45	2DH	77	4DH	109	6DH
14	0EH	46	2EH	78	4EH	110	6EH
15	0FH	47	2FH	79	4FH	111	6FH
16	10H	48	30H	80	50H	112	70H
17	11H	49	31H	81	51H	113	71H
18	12H	50	32H	82	52H	114	72H
19	13H	51	33H	83	53H	115	73H
20	14H	52	34H	84	54H	116	74H
21	15H	53	35H	85	55H	117	75H
22	16H	54	36H	86	56H	118	76H
23	17H	55	37H	87	57H	119	77H
24	18H	56	38H	88	58H	120	78H
25	19H	57	39H	89	59H	121	79H
26	1AH	58	3AH	90	5AH	122	7AH
27	1BH	59	3BH	91	5BH	123	7BH
28	1CH	60	3CH	92	5CH	124	7CH
29	1DH	61	3DH	93	5DH	125	7DH
30	1EH	62	3EH	94	5EH	126	7EH
31	1FH	63	3FH	95	5FH	127	7FH

The decimal value of MIDI channel, Program change, etc is the decimal number in the table plus 1.
 In the hexadecimal notation in configured 7 bits, the maximum data of 1 byte is 128. If the data is more than 128, used plural bytes.
 The signed value is 00H = -64, 40H = 0, 7FH = +63. In decimal notation, the value is the decimal number in the table minus 64.
 The signed value of dual bytes is 00 00H = -8192, 40 40H = 0, 7F 7FH = 8191. For example, converted aaH bbH (hex) to decimal to the following: aa bbH — 40 00H = aa x 128 + bb - 64 x 128

Table A-2: ASCII code

Patch Name and Performance Name of MIDI data are described the ASCII code in the table below.

(H) = hexadecimal

Character	(H)	Character	(H)	Character	(H)	Character	(H)
(Space)	20H						
A	41H	Q	51H	j	6AH	1	31H
B	42H	R	52H	k	6BH	2	32H
C	43H	S	53H	l	6CH	3	33H
D	44H	T	54H	m	6DH	4	34H
E	45H	U	55H	n	6EH	5	35H
F	46H	V	56H	o	6FH	6	36H
G	47H	W	57H	p	70H	7	37H
H	48H	Y	59H	q	71H	8	38H
I	49H	Z	5AH	r	72H	9	39H
J	4AH	a	61H	s	73H	0	30H
K	4BH	b	62H	t	74H	+	2BH
L	4CH	c	63H	u	75H	-	2DH
M	4DH	d	64H	v	76H	-	2AH
N	4EH	e	65H	w	77H	/	2FH
O	4FH	f	66H	x	78H	#	23H
P	50H	g	67H	y	79H	!	21H
		h	68H	z	7AH	,	2CH
				i	69H	.	2EH

MIDI Implementation Chart

Function...	Transmitted	Recognized	Remarks
Basic Channel	Default X Changed X	1 — 16 1 — 16	Memorized
Mode	Default X Messages X Altered *****	Mode 3 Mode 3, 4 (M = 1)	
Note Number :	True Voice X *****	0 — 127 0 — 127	
Velocity	Note ON X Note OFF X	O O	
After Touch	Key's X Ch's X	X O	
Pitch Bend	X	O	Resolution: 9 bits
Control Change	0, 32 X 1 X 5 X 6, 38 X 7 X 10 X 11 X 64 X 65 X 66 X 67 X 91 X 93 X 98, 99 X 100, 101 X	O *1 O *2 O *2 O *2 O *1 O *2 O *2 O *1 O *2 O *2 O *2 O *2 O *2 O *2 O *1 O *2	Bank select Modulation Portamento time Data entry Volume Panpot Expression Hold 1 Portamento Sostenuto Soft Reverb Chorus NRPN LSB, MSB RPN LSB, MSB
Prog Change	: True # X *****	O *1 0 — 127	
System Exclusive	O	O	
System Common	: Song Pos X : Song Sel X : Tune X	X X X	
System Real Time	: Clock X : Commands X	X X	
Aux Message	: All Sound Off X : Reset All Controllers X : Local ON/OFF X : All Notes Off X : Active Sense O : Reset X	O O X O (123 — 127) O O X	
Notes	* 1 O X is selectable * 2 O X is selectable using external MIDI device		

Mode 1 : OMNI ON, POLY

Mode 2 : OMNI ON, MONO

O : Yes

Mode 3 : OMNI OFF, POLY

Mode 4 : OMNI OFF, MONO

X : No

 Roland®

17048247

UPC

17048247



1298:

Roland