

DARKSTAR SYNTHESIS

DARKSTAR

8 VOICE POLYPHONIC SYNTHESIZER



Thank you for purchasing the RED Sound DARKSTAR 8-voice polyphonic synthesizer.

The Analogue Synthesiser, mainstay of Seventies' and Eighties' music, is back, reinvented in a new, more reliable and flexible form. Physical modelling via powerful DSPs (Digital Signal Processors) allow all the warmth and control of the synthesizers of yesteryear without the problems of unstable tuning and unrepeatabe sounds, and with modern benefits like realtime control and multitimbral access.

Welcome to DARKSTAR, an 8-voice polyphonic synthesiser with all the highlights of the analogue tradition, Pulse Width Modulation, Ring Mod, Resonant Filtering and ADSR Enveloping, combined with all the advantages of modern MIDI instruments like rock-solid tuning, perfect program recall, velocity response and 5 different timbres simultaneously available.

So whether your aim is to recreate 'classic' timbres like 70's Disco Bassline / Screaming PWM Lead, chart new sonic territory with realtime joystick manipulation of ring modulation and velocity controlled resonance, or even combine both approaches in the same MIDI sequence, DARKSTAR is the perfect tool for you.

In the future, DARKSTAR's capabilities will grow thanks to the ability to change its EPROM-based DSP algorithms. This will allow you to convert DARKSTAR into many different products such as a mega-mono synthesizer or vocoder.

But DARKSTAR already offers so much with its marriage of proven synthesis techniques and state-of-the-art control. Now it's time to unlock the potential of analogue-style synthesis with modern control techniques in your music.

Be creative!

FRONT PANEL

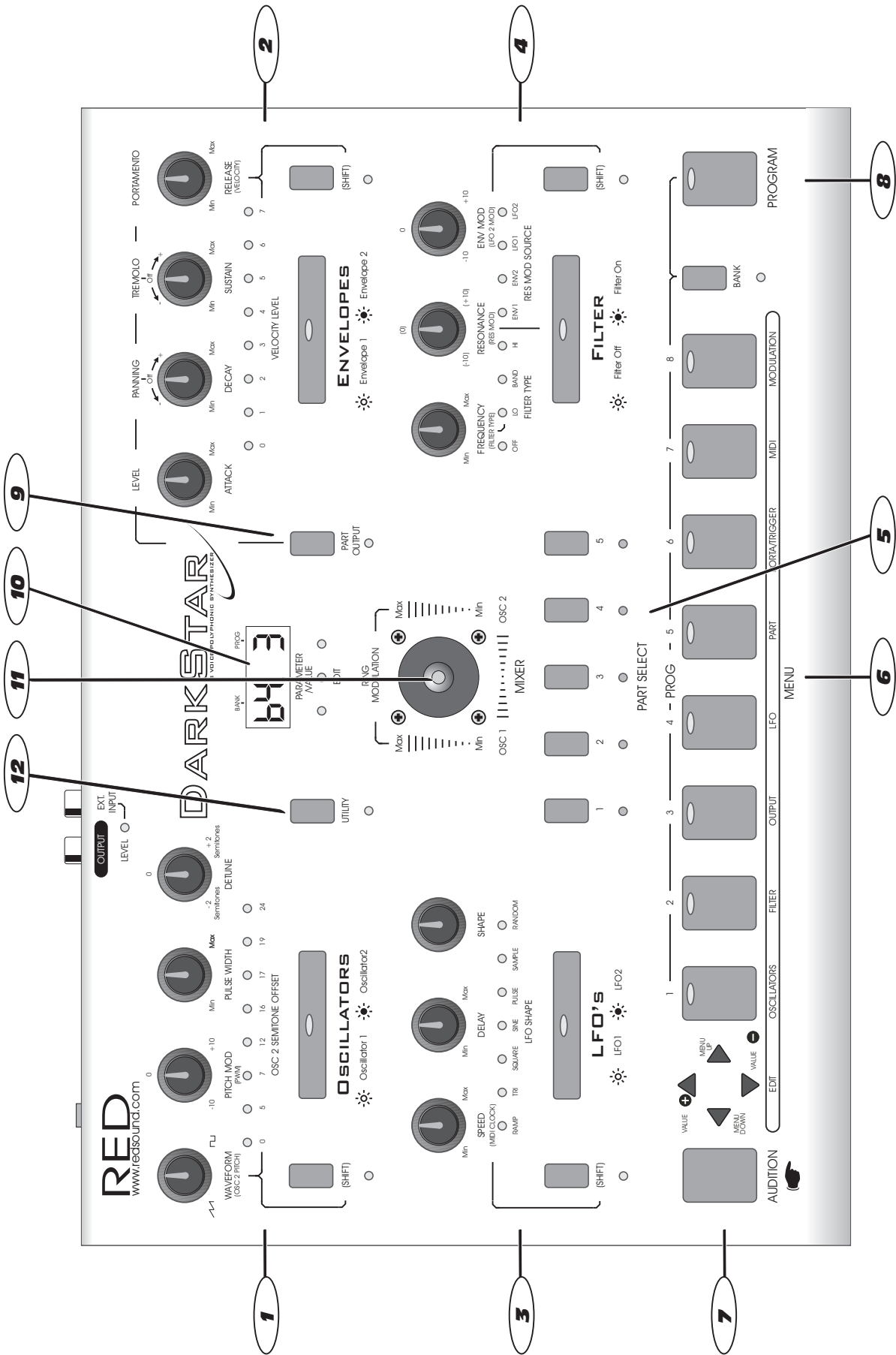

FRONT PANEL FEATURES

- 1. OSCILLATORS:** This section features [WAVEFORM], [PITCH MOD], [PULSE WIDTH] and [DETUNE] controls for each oscillator. The large [OSCILLATOR] button switches between oscillators 1 & 2. The [SHIFT] button is used to access the [OSC 2 PITCH] and [PWM] controls in the oscillator sub-menu.
- 2. ENVELOPES:** This section features [ATTACK], [DECAY], [SUSTAIN] and [RELEASE] controls for each envelope. The large [ENVELOPE] button switches between envelopes 1 & 2. The [SHIFT] button is used to access the [VELOCITY] control in the envelope sub-menu.
- 3. LFO'S:** This section features [SPEED], [DELAY] and [SHAPE] controls for each LFO. The large [LFO] button switches between LFO 1 & 2. The [SHIFT] button is used to access the [MIDI CLOCK] control in the LFO sub-menu.
- 4. FILTER:** This section features [FREQUENCY], [RESONANCE] and [ENV MOD] controls for the filter. The large [FILTER] button switches the filter on and off. The [SHIFT] button is used to access the [FILTER TYPE], [RES MOD] and [LFO 2 MOD] controls in the oscillator sub-menu.
- 5. PART SELECT:** These buttons are used to select the 5 Multitimbral 'PARTS'. You can create and store 5 totally different sounds in each program.
- 6. MENU:** This section features 8 menu buttons and a 4-way keypad. The MENU buttons are used to select additional parameters for editing whilst the [EDIT] keypad is used to scroll up and down the menu and change the values.
- 7. AUDITION:** This button can be used to trigger the currently selected PART.
- 8. PROGRAM:** This section features the [PROGRAM] and [BANK] buttons which are used to select the 8 banks of 8 programs (total programs = 64).
- 9. PART OUTPUT:** This button is used to access the [LEVEL], [PANNING], [TREMOLO] and [PORTAMENTO] parameters for each individual PART.
- 10. PARAMETER/VALUE DISPLAY:** This 4-digit LED display shows bank/program numbers, parameter information and edit values.
- 11. MIXER:** The joystick mixer adjusts the balance between OSCILLATORS 1 and 2 (or external input) and also sets the amount of RING MODULATION.
- 12. UTILITY:** This button is used to access the SYSTEM EXCLUSIVE utility parameters.

REAR PANEL

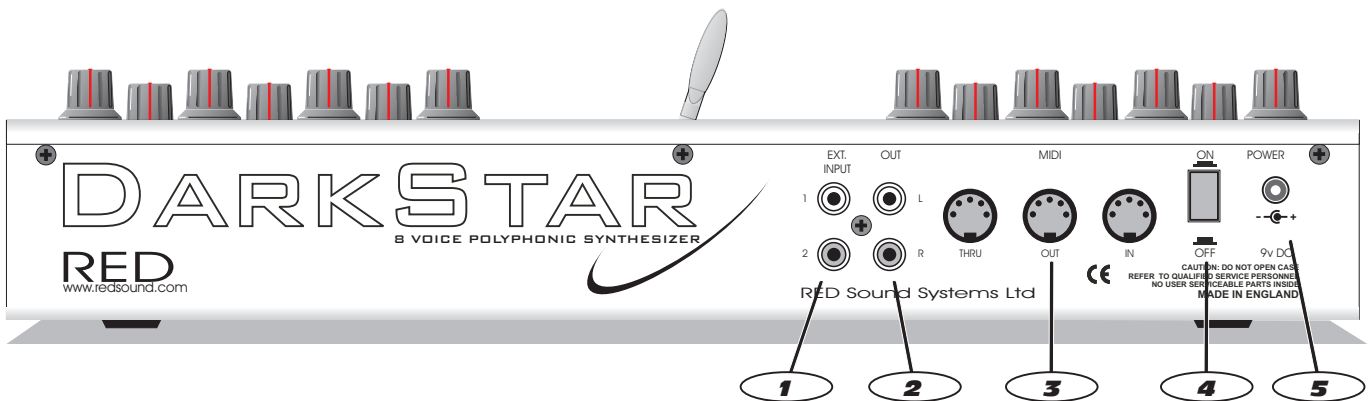

1. EXTERNAL INPUTS 1&2 - RCA Phono Connectors

Use these sockets to connect any external line level sound sources to DARKSTAR for filter/envelope processing.

2. STEREO OUTPUT - RCA Phono Connectors

Use these sockets to connect DARKSTAR to your mixing desk or amplification system.

3. MIDI IN/OUT/THRU - Connectors

MIDI data will be transmitted and received by these connectors.

4. POWER - Switch

This turns the power on and off.

5. DC POWER IN - Connector

Only use the 9vDC 800 mA PSU supplied with DARKSTAR to power the unit.

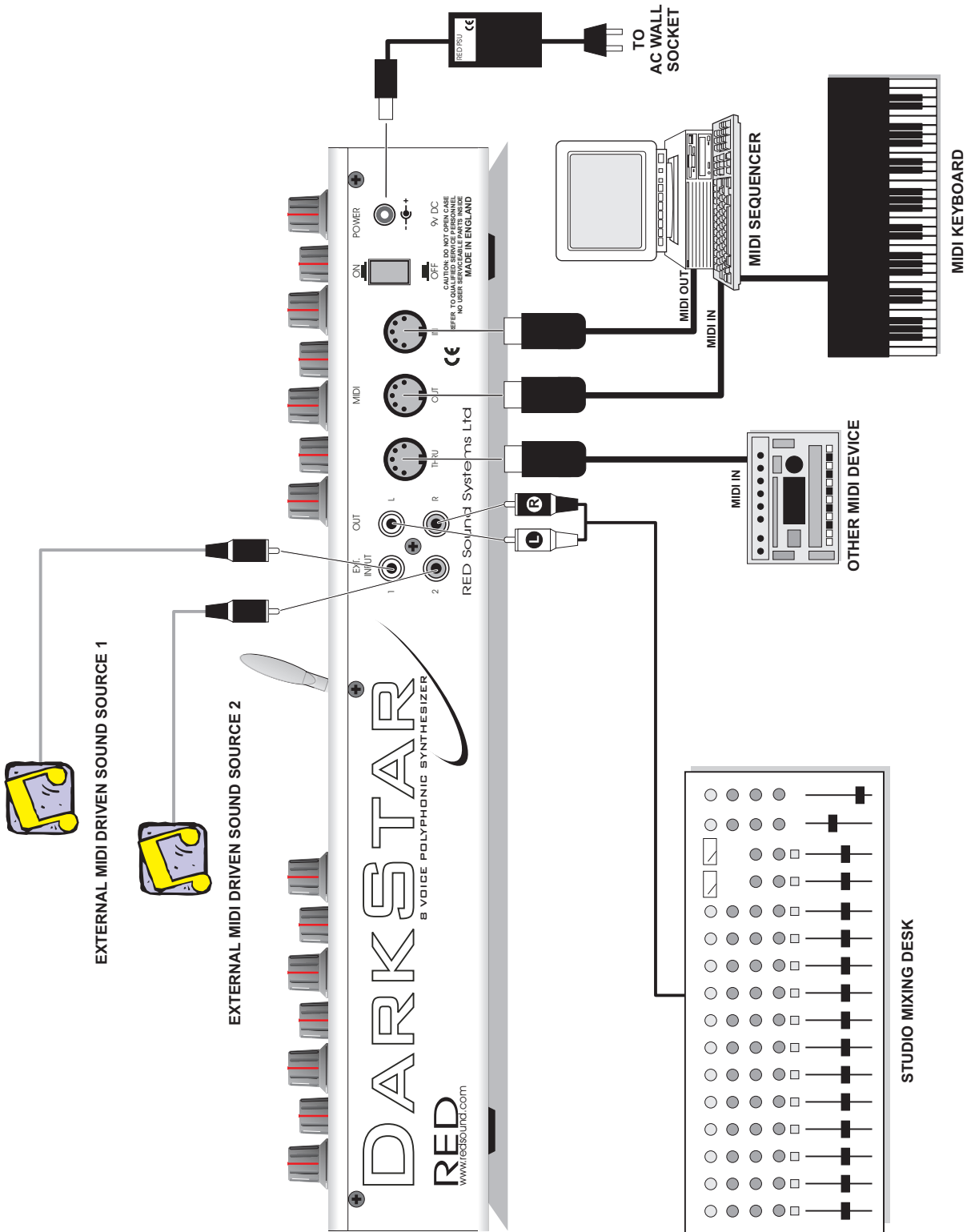

QUICK START

QUICK START

If you want to quickly try out the performance of DARKSTAR, please read the following points carefully:

CONNECTIONS: Before making any connections, make sure that the power on all your equipment is turned OFF. Connect the power supply (included) to the 'power in' socket on the rear panel of DARKSTAR and plug it into a suitable AC outlet. Connect the audio cables for a basic system setup as shown on page 5.

TURNING ON THE POWER: Make sure all connections have been made correctly and the volume controls on the mixing desk and amplifier system are turned completely down. Press the rear panel power switch on DARKSTAR. Turn on the power of the mixing desk and then turn on the power of the amplifier system.

POWER UP INDICATIONS: When DARKSTAR is powered up, the main display will show the software version whilst various parameters are being set internally. When this process is complete, the display will show the BANK and PROGRAM number. If this does not happen, check the power supply is of the correct type and the unit was switched on correctly.

SETTING THE MIDI RECEIVE CHANNEL: To select the correct MIDI receive channel press the [MIDI] MENU button and use the [EDIT] keypad [VALUE +] and [VALUE -] buttons to set the channel of the active PART (as DARKSTAR can have up to 5 different sounds/MIDI channels setup in each PROGRAM you may have to change the MIDI transmit channel on your keyboard a few times to play all the sounds).

SELECTING A PROGRAM: To select the factory programs in BANK 1, press and hold the [PROGRAM] button (LED on) and then press one of the buttons marked 1-8. To select one of the other 7 banks of 8 programs press and hold the [PROGRAM] button then press the [BANK] button. Now you can select one of the 8 programs in the new bank using the buttons marked 1-8 (*keep your finger on the [PROGRAM] button at all times when selecting programs/banks*).

NOTE: Banks 1 to 6 (48 programs) feature factory presets that demonstrate the sonic power of DARKSTAR. Programs in banks 7 and 8 all contain the same basic sound ready for you to overwrite with newly created sounds.

Use the [AUDITION] button or connected MIDI keyboard to trigger the sounds. You can modify the sounds in real-time by altering the controls in the OSCILLATOR, FILTER, ENVELOPE and LFO sections.

Please read the following "OPERATION" section carefully to fully appreciate the range of features and facilities the DARKSTAR 8-Voice Synthesizer has to offer.

GETTING STARTED

After connecting DARKSTAR to your system as detailed on page 5, press in the power switch on the rear panel to turn the power on. As the software is initialising (takes approximately 12 seconds) rows of indicators will light in sequence and the version number fitted to your unit will be shown on the main display:

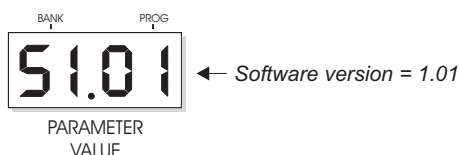

Afterwards, the last selected program (before power was switched off at the previous session) will be recalled and displayed as follows:

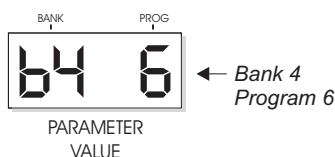

OSCILLATOR SECTION

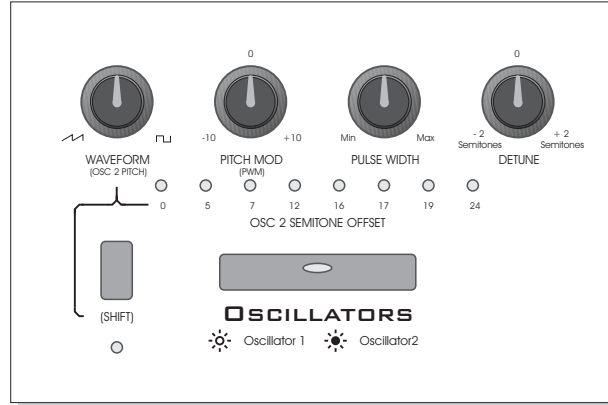

This section of DARKSTAR produces the musical tones which form the basis of subtractive synthesis. There are two oscillators per 'voice' (musical note), each producing audible vibrations to act as a sound source. The timbre of each oscillator depends on its harmonic content which is determined by the waveform. There are basically two waveforms available, SAWTOOTH and RISING, each with its own specific set of harmonics.



Controls for changing the amount of modulation to the pitch timbre of the oscillators are also included in this section. These timbral and pitch modulations give the oscillator sound more depth and stimulate musical appeal to the ear.

OSCILLATOR SELECT button

This large button switches between oscillator 1 and 2. When the indicator is OFF, oscillator 1 will be selected. When the indicator is ON, oscillator 2 will be selected.

WAVEFORM (OSC 2 PITCH)

This control has two functions determined by the [SHIFT] button.

When the [SHIFT] function is *NOT selected* (SHIFT LED Off), this control sets the selected oscillator's waveform. At the fully anti-clockwise position () the waveform will be shaped like a SAWTOOTH. This waveform contains every harmonic in decreasing volume and produces a very rich sound. As the control is moved in a clockwise direction the shape progressively changes, becoming more and more 'squared-off' until, at the fully clockwise position () the shape will be a SQUARE or 'pulse' waveform. As a pure square wave (max and min values equal) the harmonic content will be all the odd-numbered harmonics in decreasing volume which gives the sound a hollow or 'woody' timbre. The width of the pulse can also be altered by the [PULSE WIDTH] knob to make the sound thinner.

When the [SHIFT] function is selected (SHIFT LED Flashing), this control sets the amount of oscillator 2 pitch offset. This detune setting is calibrated in semitones with the eight indicators labelled [OSC 2 SEMITONE OFFSET] showing the value, as in the following example:

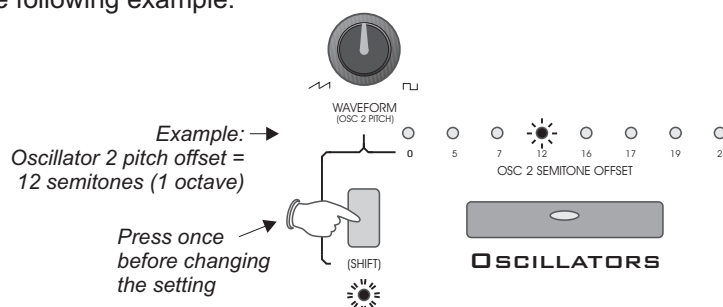

PITCH MOD (PWM)

This control has two functions determined by the [SHIFT] button.

When the [SHIFT] function is *NOT selected* (SHIFT LED Off), this control sets the amount of pitch modulation to the selected oscillator. At the 12 o'clock position there will be no pitch modulation applied. As the knob is moved in an anti-clockwise direction the pitch modulation will become negative, first falling then rising. At the fully anti-clockwise position the modulation will be at its maximum negative depth. As the knob is moved in a clockwise direction from the centre position, the pitch modulation will become positive, first rising then falling. At the fully clockwise position the modulation will be at its maximum positive depth. See [OSCILLATOR] menu section below for further details on the pitch modulation source.

When the [SHIFT] function is selected (SHIFT LED Flashing), this control sets the amount of pulse width modulation or PWM for the selected oscillator when its [WAVEFORM] is set to SQUARE (□). The PWM SOURCE can be set to LFO1, LFO2, ENV1 or ENV2 (see [OSCILLATOR] menu) with negative and positive modulations available. At the 12 o'clock position there will be no PWM. As the knob is moved in an anti-clockwise direction the variation in the pulse width will become more and more pronounced in a negative manner. As the knob is moved in a clockwise direction the variation in the pulse width will become more and more pronounced in a positive manner.

PULSE WIDTH

This control sets the actual width of the pulse. At the fully anti-clockwise position the fundamental will be at its minimum producing an extremely thin sound. As the knob is moved in a clockwise direction the pulse width gets wider, with progressively less high harmonics being added giving the sound a fuller timbre. At the fully clockwise position the minimum and maximum values of the pulse width will be equal.

DETUNE

This control sets the fine tuning for each oscillator. At the 12 o'clock position the oscillators tuning will be unaffected. As the knob is moved in an anti-clockwise direction the oscillators tuning will become more 'Flat', with a total negative detune of - 2 semitones available at the fully anti-clockwise position. As the knob is moved in a clockwise direction the oscillators tuning will become more 'Sharp', with a total positive detune of + 2 semitones available at the fully clockwise position. Small variations in the oscillators relative tuning will fatten up a sound giving it a rich texture. Larger amounts of detuning create a more extreme effect.

OSCILLATOR MENU

This section contains the remaining functions for the oscillators. To access these settings, press the MENU button labelled [OSCILLATORS], as shown in the following example:

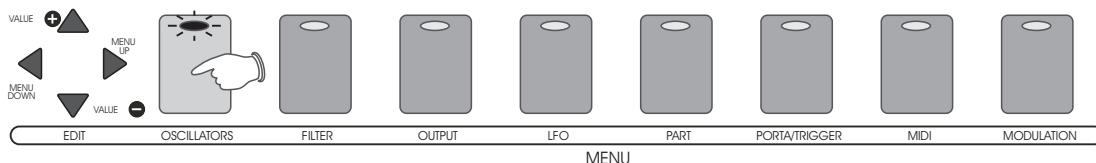

The indicator in the [OSCILLATOR] button will light and the main display will now alternate between the first function and its current value, as shown below:



There are 4 functions in the oscillator menu with multiple settings as detailed in the following paragraphs.

1. Pitch Modulation Source: This function allows you to derive the selected oscillator's PITCH modulation from one of four different sources. The selections are:

- Envelope1** - The settings of envelope 1 controls will affect the oscillators pitch.
- Envelope 2** - The settings of envelope 2 controls will affect the oscillators pitch.
- LFO1** - The settings of the LFO1 controls will affect the oscillators pitch.
- LFO2** - The settings of the LFO2 controls will affect the oscillators pitch.

2. Pulse Width Modulation source: This function allows you to link the selected oscillator's PULSE WIDTH modulation to one of four different sources. The selections are:

- Envelope1** - The settings of envelope 1 controls will affect the oscillators pulse width modulation.
- Envelope 2** - The settings of envelope 2 controls will affect the oscillators pulse width modulation.
- LFO1** - The settings of the LFO1 controls will affect the oscillators pulse width modulation.
- LFO2** - The settings of the LFO2 controls will affect the oscillators pulse width modulation.

3. Oscillator 2 source: This function allows you to select the sound source for OSCILLATOR 2. The selections are:

- Type 1(normal oscillator)** - This oscillator contains the full range of frequencies.
- Type 2(Formant style oscillator)** - This oscillator is formed from a limited band of frequencies.
- Noise1(Pink)** - PINK noise has the higher frequencies reduced.
- Noise 2(White)** - WHITE noise and has all frequencies at an equal level.
- Noise 3(Blue)** - BLUE noise has the lower frequencies reduced.
- External Input1&2** - You can switch off all the internal sound generators for oscillator 2 and instead use the rear panel connectors marked [EXTERNAL INPUTS 1 - 2] to process any MIDI driven external sound source through the filter and envelope sections. See page 29 for further details.

4. Oscillator Sync: This function synchronises oscillator 2 with oscillator 1. The oscillator 2 waveform will now restart its cycle each time oscillator 1 starts its own cycle. The result of this keeps the pitch of both oscillators identical making a distinct change to the timbre. For the best results use envelope 2 to try and move the pitch of oscillator 2. The pitch cannot change but you will hear timbral changes to the sound with vocal characteristics. The selections are: ON and OFF.

To change the current oscillator menu setting, use the [EDIT] keypad [VALUE +] and [VALUE -] buttons as shown in the following example:

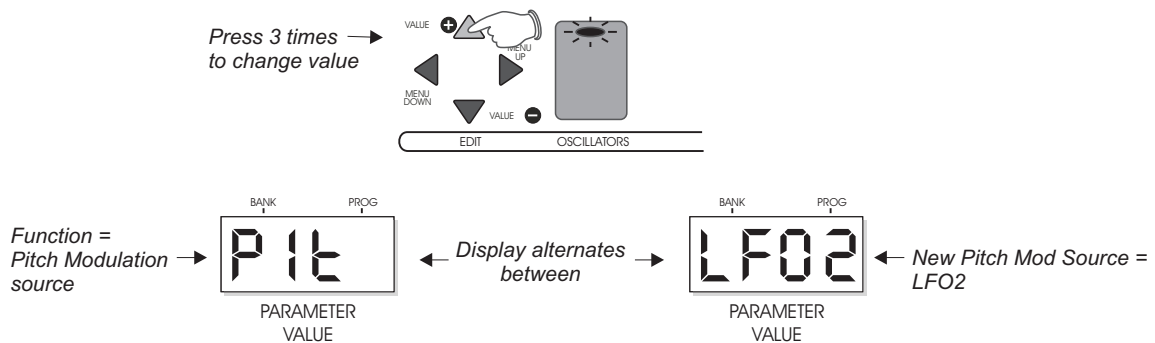

To select a different menu function, use the [MENU DOWN] and [MENU UP] buttons. To EXIT oscillator menu mode, simply press the [OSCILLATOR] MENU button and check that the indicator goes out.



ENVELOPE SECTION



This section of DARKSTAR is used to shape the sound over a period of time with two envelopes available. The first envelope is fixed to amplitude (or volume) and decides how quickly the sound starts, sustains and then fades away. The second envelope can be used to control the filter frequency, pulse width or pitch modulations to alter the character of the sound.

ENVELOPE SELECT button

This large button switches between envelope 1 and 2. When the indicator is OFF, envelope 1 will be selected. When the indicator is ON, envelope 2 will be selected.

ATTACK

This control sets the time period for the envelope to reach its maximum after a note is played. At the fully anti-clockwise position the response is virtually instantaneous giving a percussive edge to the sound. As the knob is moved in a clockwise direction the time to reach maximum gradually increases giving a softer start to the sound. At the fully clockwise position the attack time will be at its maximum.

DECAY

This control sets the rate at which the envelope falls to the [SUSTAIN] level after the maximum [ATTACK] level has been reached. At the fully anti-clockwise position the response is virtually instantaneous. As the knob is moved in a clockwise direction the decay duration gradually increases until, at the fully clockwise position the decay time will be at its maximum.

SUSTAIN

This control sets the level of the envelope after the decay element is completed and until the note is released. At the fully anti-clockwise position the envelope will continue to decay to zero without interruption. As the knob is moved in a clockwise direction the level at which the decay ends gradually increases until, at the fully clockwise position the sustain level will be at its maximum.

RELEASE (VELOCITY)

This control has two functions determined by the [SHIFT] button.

When the [SHIFT] function is *NOT selected* (SHIFT LED Off), this control sets the time taken for the sustain level to reach zero once the note has been released. At the fully anti-clockwise position the response is virtually instantaneous giving an abrupt end to the sound. As the knob is moved in a clockwise direction the release time gradually increases resulting in a softer, more natural end to the sound. At the fully clockwise position the release time will be at its maximum.

When the [SHIFT] function is selected (SHIFT LED Flashing), this control sets how much the selected envelope is affected by the velocity level. Firmly struck notes will open the envelope to its maximum level whilst softer strokes will produce a lesser result, dependent on the velocity setting. The eight VELOCITY LEVEL indicators show the velocity setting for the selected envelope. To change the setting, first press the [SHIFT] button and then move the [VELOCITY] knob. The indicators will show the value, as shown in the following example:

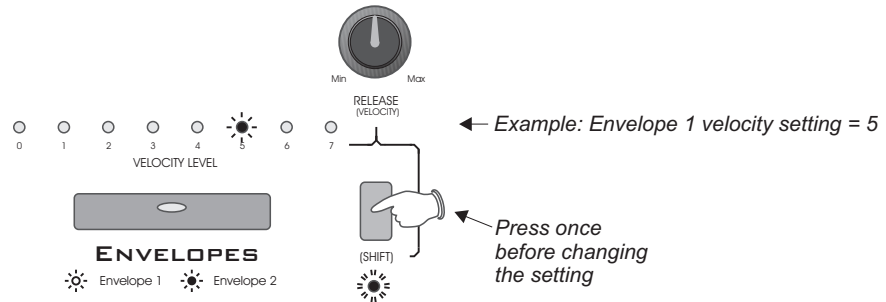

At the fully anti-clockwise position [indicator 0] there will be no velocity effect, with soft and hard notes each producing the same, maximum result. As the knob is moved in a clockwise direction [indicators 1 to 6] the envelope will open less and less when softer notes are played until, at the fully clockwise position [indicator 7] the softest notes will not open the envelope at all. On envelope 1 this maximum setting will make soft notes sound very quiet whilst on envelope 2 this will result in much less pitch, pulse width or filter modulation.

LFO SECTION

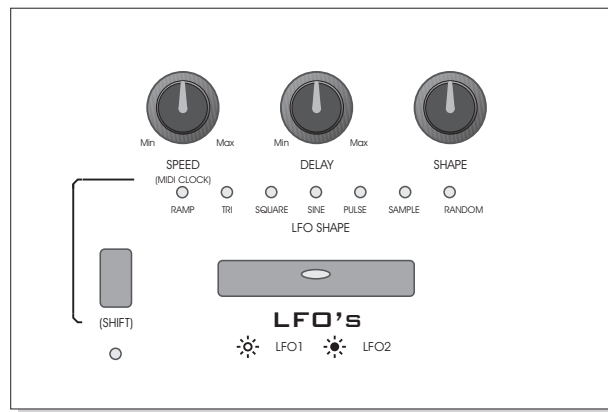

This section of DARKSTAR features 2 LFOs (Low Frequency Oscillators) which make regular electronic variations, too low to be heard when converted into audio vibrations. They can be used independently to alter elements of the sound by adding vibrato or changes to the harmonic content.

LFO SELECT button

This large button switches between LFO1 and 2. When the indicator is OFF, LFO1 will be selected. When the indicator is ON, LFO2 will be selected.

SPEED

This control has two functions determined by the [SHIFT] button.

When the [SHIFT] function is *NOT selected* (SHIFT LED Off), this control sets the rate of the selected LFO.

OPERATION

At the fully anti-clockwise position the speed will be at its slowest. As the knob is moved in a clockwise direction the speed gradually increases until, at the fully clockwise position the LFO rate will be at its maximum.

When the [SHIFT] function is selected (SHIFT LED Flashing), this control is used to synchronise the LFO with an external MIDI clock. The trigger rate can be set to a range of values from 1/8th beat to 4 bars in duration. At the fully anti-clockwise position the LFO to MIDI synchronisation feature will be OFF. As the knob is moved in a clockwise direction the trigger rate becomes less frequent until, at the fully clockwise position the LFO will cycle once every 4 bars.

To view the setting, press the [SHIFT] button. The main display will now show the current value, as shown in the following example:

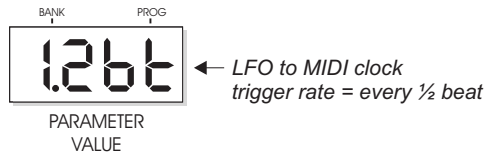

To change the setting move the [MIDI CLOCK] knob. The main display will show the new value.

Range = OFF, 1/8bt, 1/6bt, 1/4bt, 1/3bt, 1/2bt, 2/3bt, 3/4bt, 1bt, 2bt, 3bt, 1bar, 1.5 bars, 2 bars, 3 bars, 4 bars.

DELAY

This control sets the time taken for the LFO to be introduced after a note is struck. At the fully anti-clockwise position the LFO will start immediately. As the knob is moved in a clockwise direction the delay period before the LFO starts will gradually increase until, at the fully clockwise position the delay time will be at its maximum.

SHAPE

This control selects the waveform which determines the contour of the LFO modulation. There are 8 waveforms to choose from as follows:

- RAMP [/]
- TRI [^]
- SQUARE [□]
- SINE [~]
- PULSE [▭]
- SAMPLE&HOLD [▭]
- RANDOM [~]

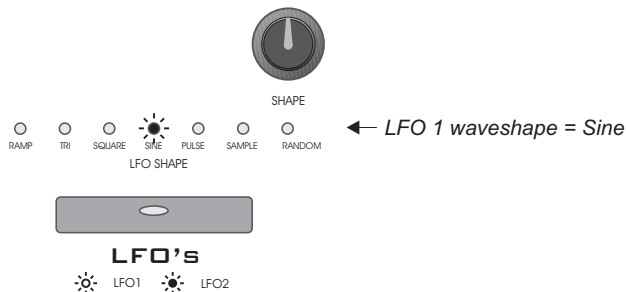

LFO MENU

This section contains the remaining functions for the LFOs. To access the LFO settings, press the MENU button labelled [LFO], as shown in the following example:

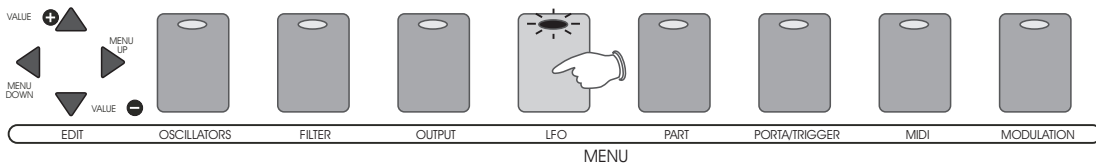

The indicator in the [LFO] button will light and the main display will now alternate between the first function and its current value, as shown below:

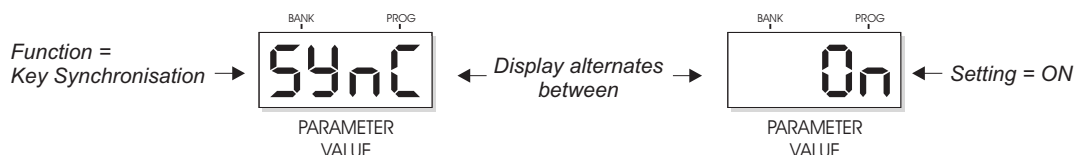

The first function in the LFO menu is:

1. Key Synchronisation: This function sets the LFOs to start from the beginning of the selected waveform each time a note is played. The selections are:

Off - The waveforms of all LFOs are synchronised but will be free running.

On - The waveforms of all LFOs are synchronised but will re-start from the beginning of the selected waveshape each time a note is played.

To EXIT LFO menu mode, simply press the [LFO] MENU button and check that the indicator goes out.

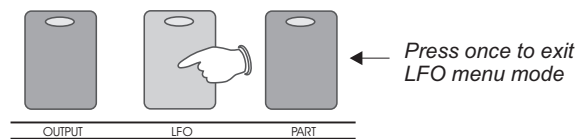

FILTER SECTION

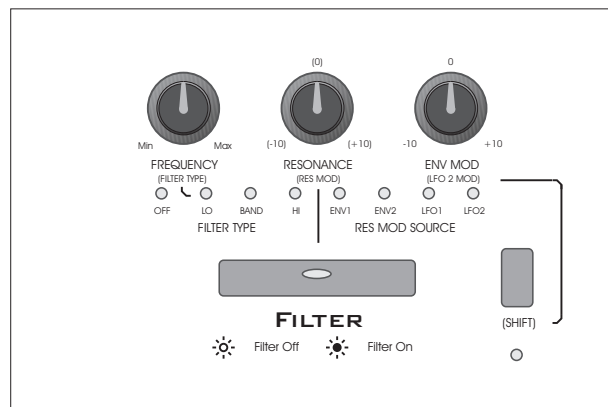

This section of DARKSTAR features a classic 12dB per octave filter which, in subtractive synthesis, is used to remove unwanted frequencies. There are three different types of filter to choose from, LOW PASS, BAND PASS and HIGH PASS or the filter can be totally switched off.

FILTER SELECT button

This large button switches the filter on and off. When the indicator is OFF the filter will be bypassed. When the indicator is ON the filter will be active.

FREQUENCY (FILTER TYPE)

This control has two functions determined by the [SHIFT] button.

When the [SHIFT] function is *NOT* selected (SHIFT LED Off), this control sets the basic cut-off frequency of the filter. The affect this control has on the sound depends on the type of filter selected (low, band or high-pass), as detailed in the following paragraph.

When the [SHIFT] function is selected (SHIFT LED Flashing), this control selects the FILTER TYPE. The four indicators labelled FILTER TYPE show the current setting at all times. To change the filter type, first press the [SHIFT] button and then move the [FILTER TYPE] knob. The indicators will show the value, as shown in the following example:

OPERATION

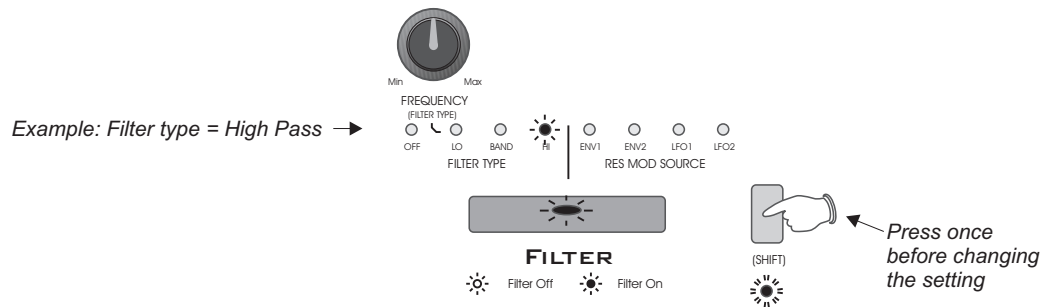

At or near the fully anti-clockwise position the LOW PASS filter type will be selected:

LOW-PASS: This type of filter allows the low frequency elements to pass whilst reducing the higher frequencies as the FREQUENCY control is moved *anti-clockwise*.

About the 12 o'clock position the BAND PASS filter type will be selected:

BAND-PASS: This type of filter allows a limited band of frequencies to pass whilst reducing the remaining high and low frequencies, the filtered frequency band being set by the position of the FREQUENCY control.

At or near the fully clockwise position the HIGH PASS filter type will be selected:

HIGH-PASS: This type of filter allows the high frequency elements to pass whilst reducing the lower frequencies as the FREQUENCY control is moved *clockwise*.

RESONANCE (RES MOD)

This control has two functions determined by the [SHIFT] button.

When the [SHIFT] function is *NOT selected* (SHIFT LED Off), this control sets the boost level of the frequencies around the cut-off point as set by the FREQUENCY control. At the fully anti-clockwise position there is no boost. As the control is moved in a clockwise direction the frequencies will be gradually increased until, at the fully clockwise position, the resonance will reach self-oscillation producing a new pitched element similar to acoustic feedback.

When the [SHIFT] function is selected (SHIFT LED Flashing), this control sets the level of resonance modulation. At the 12 o'clock position there will be no resonance modulation. As the knob is moved in an anti-clockwise direction the amount of resonance modulation will become more and more pronounced in a negative manner. As the knob is moved in a clockwise direction the amount of resonance modulation will become more and more pronounced in a positive manner - see [FILTER] MENU below for details on selecting the resonance modulation source.

ENV MOD (LFO 2 MOD)

This control has two functions determined by the [SHIFT] button.

When the [SHIFT] function is *NOT selected* (SHIFT LED Off), this control sets the amount of change (depth) of the cut-off frequency as set by the FREQUENCY control. At the 12 o'clock position there will be no change to the filter cut-off frequency. As the control is moved in an anti-clockwise direction the filter will be increasingly opened by the audio modulation in a negative manner. As the knob is moved in a clockwise direction from the centre position the filter will be increasingly opened by the audio modulation in a positive manner.

When the [SHIFT] function is selected (SHIFT LED Flashing), this control sets the level of LFO 2 modulation. At the 12 o'clock position there will be no LFO 2 modulation applied. As the knob is moved in an anti-clockwise direction LFO 2 modulation will be applied more and more in a negative manner. As the knob is moved in a clockwise direction from the centre position LFO 2 modulation will be applied more and more in a positive manner.

FILTER MENU

This section contains the remaining functions for the filter. To access these settings labelled [FILTER], as shown in the following example:

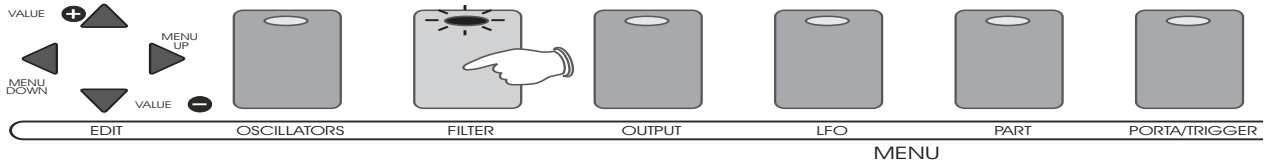

The indicator in the [FILTER] button will light and the main display will now alternate its current value, as shown below:

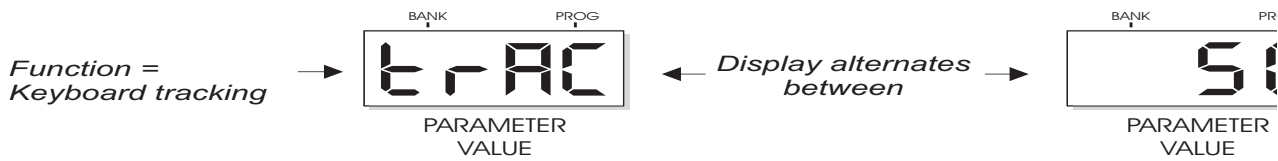

The functions in the filter menu are:

1. Keyboard tracking: This function lets you choose whether the filter has the same range or has a different effect on the lower and higher notes. This function is applied to the filter. The selections are:

- Off** - The keyboard tracking is off and so the filter's effect will be the same across all notes.
- 25, 50, 100, 150%** - The keyboard tracking is now on. The filter will now open increasingly more for the high notes until the effect is at its maximum when the level is set to 150%. The settings included, **-25 and -50** where the filter will open less for the *high* notes and more for the *low* notes.

2. Resonance Modulation Source: This function allows you to derive the filter resonance modulation from four different sources. The selections are:

- Envelope 1** - The settings of envelope 1 controls will affect the resonance modulation.
- Envelope 2** - The settings of envelope 2 controls will affect the resonance modulation.
- LFO1** - The settings of the LFO1 controls will affect the resonance modulation.
- LFO2** - The settings of the LFO2 controls will affect the resonance modulation.

To select a different menu function, use the [MENU UP] and [MENU DOWN] buttons:

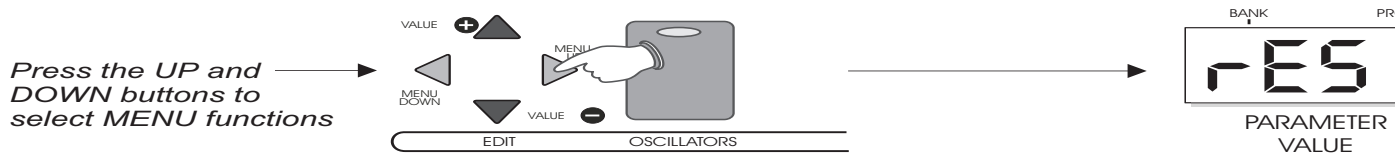

To EXIT filter menu mode, simply press the [FILTER] MENU button and check that

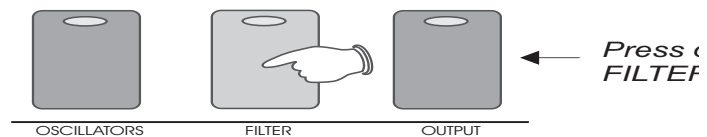

OPERATION

MIXER Joystick Control

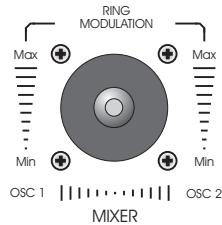

The centrally mounted joystick [MIXER] control is a unique feature of DARKSTAR which allows you to mix between the oscillators (or external sound sources) and ring modulation 'on-the-fly' for extra expression and creative power.

OSCILLATOR 1-2 MIXING

The balance between oscillators 1 & 2 can be varied according to the 'X' axis (left-to-right) position. To hear oscillator 1 by itself position the joystick knob at the South-West (lower left) position, as shown in the following diagram:

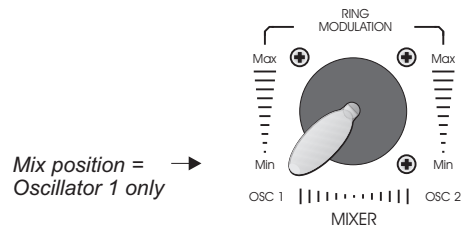

To hear oscillator 2 by itself position the joystick knob at the South-East (lower right) position, as shown in the following diagram:

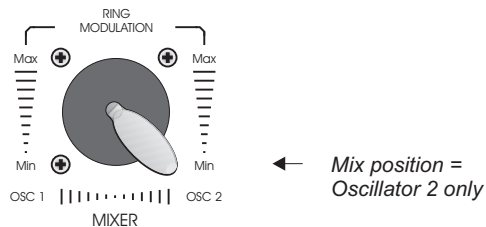

To hear oscillator 1 & 2 together at equal levels, position the joystick knob at the due-South (lower centre) position, as shown in the following diagram:

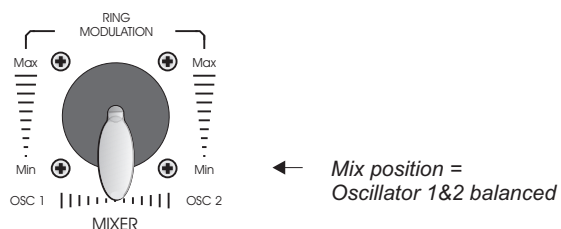

RING MODULATION

Ring modulation occurs when the two sound sources are multiplied together and this gives the resultant sound a powerful, metallic edge. To introduce ring modulation on both sound sources simultaneously, move the joystick away from the due-South position, as shown in the following example:

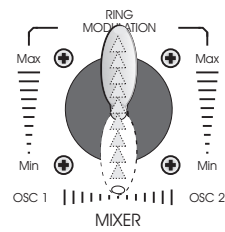

← *Ring Modulation = maximum setting on both sound sources*

To introduce high levels of ring modulation on one sound source more than the other, move the joystick away from the centre line towards the North-West or North-East positions, as shown in the following example:

Ring Modulation ⇒
mainly oscillator 1



← *Ring Modulation = mainly oscillator 2*



Try moving the joystick around its axis whilst making changes to the filter [FREQUENCY] and [RESONANCE] controls to hear how these controls react with one another.

MULTITIMBRAL PARTS

This section of DARKSTAR lets you to set up to five different sounds on each program for multiple sound generation. You can specify the number of voices, note range, transposition, MIDI channel and other parameters for each individual sound so that for instance, a fat dirty bass sound can be played right alongside a warm string sound simultaneously on the same keyboard. When connected to a MIDI sequencer you can really get the maximum sound generating power out of DARKSTAR by setting each PART to different MIDI channels for complex synthesizer layering.

The five [PARTS SELECT] buttons grouped beneath the joystick mixer are used to select the active PART for editing. When a [PART] button indicator is on, any changes to the front panel controls and/or MENU functions will be applied to that part only.

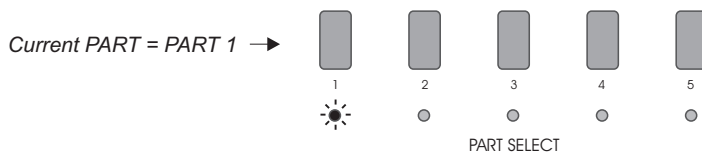

To select another PART, press the required [PART] button as shown in the following example:

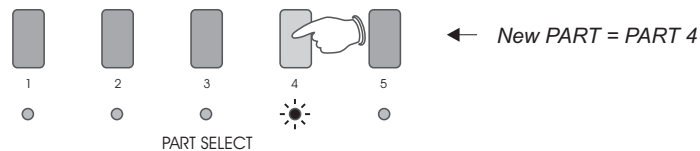

PART COPY: You can copy all the parameter settings from one PART to another. This allows you to quickly build up powerful unison sounds on a single MIDI channel - see page 26 for further details.

Before creating the sound for a PART you must first setup the basic 'structure' which defines how the PART is played and what limitations will apply in relation to the other PARTS. The following functions and associated parameters can be set for each part, namely:

1. **[MENU] PART button:** POLYPHONY, KEY TRANSPOSE, NOTE RANGE - LOW, NOTE RANGE - HIGH
2. **[MENU] MIDI button:** MIDI CHANNEL, SUSTAIN, PITCH BEND RANGE,
3. **[PART OUTPUT] button:** OUTPUT LEVEL, PANNING LEVEL / SOURCE, TREMOLO LEVEL / SOURCE PORTAMENTO LEVEL / TYPE, AUTO-GLIDE ON/OFF

MENU - PART button

This section contains the first four functions for PART editing. To access these settings, press the MENU button labelled [PART], as shown in the following example:

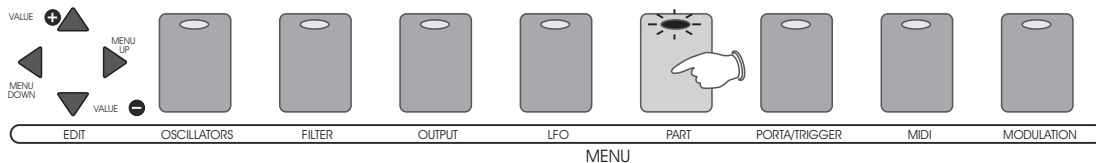

The indicator in the [PART] button will light and the main display will show the first function which is:

1: POLYPHONY

This function allows you set the maximum note allocation for each PART. The DARKSTAR synthesizer has a total number of 8 notes or 'voices' available and you must carefully allocate these between the different PARTS so as not to leave unused voices on one PART whilst missing notes played (because of under-allocation) on another. As an example, a bass sound will probably only require one or two notes to be played at any one time so it would be extremely wasteful to allocate any higher number of voices to this type of sound. Also, this will leave a greater number of spare voices for parts where you want to use chords.

With this first menu function selected the main display will alternate as follows:

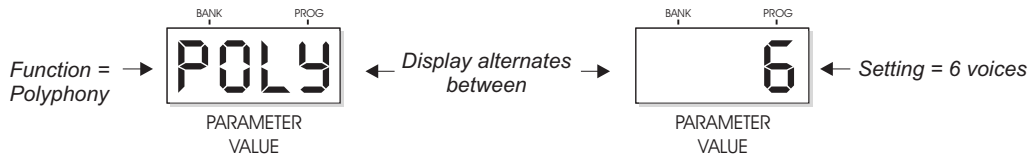

RANGE = 0 to 8 notes/voices

Use the menu [EDIT - VALUE + and VALUE -] buttons to change the setting as follows:



With all 8 voices assigned there will be no further allocation allowed.

e.g. if PART 1 = 3 voices, PART 2 = 1 voice and PART 3 = 4 voices you will be unable to set any further voices for PARTS 4 and 5. If you wish to create an additional PART, go back and lower the voice allocation for the existing PARTS or setup another PROGRAM.

2: KEY TRANSPOSE

This function allows you to change the musical key of the selected PART by moving it up or down, in single semitone steps to a maximum of +/- 24 notes (2 octaves). With the second menu function selected the main display will alternate as follows:



RANGE = 0 to +24 semitones, 0 to -24 semitones

Use the menu [EDIT - VALUE + and VALUE -] buttons to change the setting as follows:

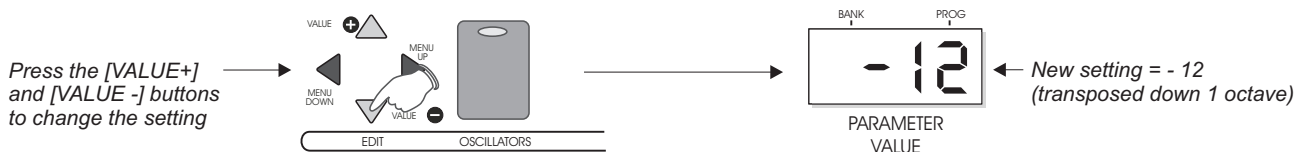

3: NOTE RANGE - LOW

This function allows you to set the LOW note range for the selected PART. By allocating groups of notes to each PART you can play up to five different sounds simultaneously on a single keyboard using just one MIDI channel. With the third menu function selected the main display will alternate as follows:



RANGE = 0 to 100 notes (limited by setting of NOTE RANGE - HIGH e.g. the highest LOW NOTE value will be determined by the note value set in NOTE RANGE - HIGH) - see next section.

OPERATION

Use the menu [EDIT - VALUE + and VALUE -] buttons to change the setting as follows:

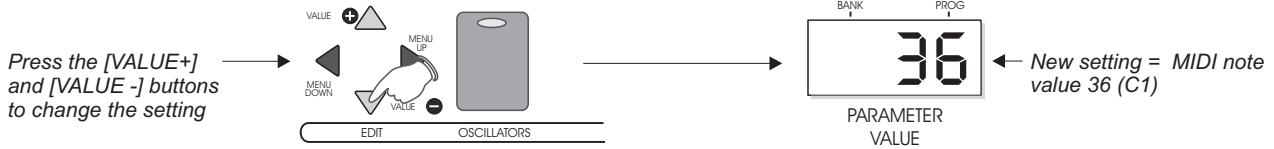

4: NOTE RANGE - HIGH

This function allows you to set the HIGH note range for the selected PART. The lowest HIGH NOTE value will be determined by the note value set in NOTE RANGE - LOW. With the fourth menu function selected the main display will alternate as follows:



RANGE = 0 to 100 notes (limited by setting of NOTE RANGE -LOW).

Use the menu [EDIT - VALUE + and VALUE -] buttons to change the setting as follows:

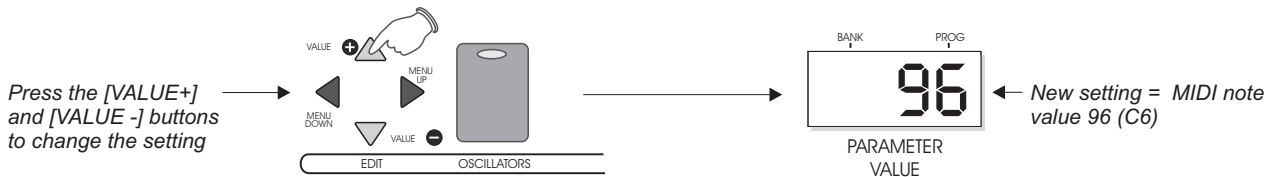

MENU - MIDI button

This section contains three PART functions related to MIDI. To access these settings, press the MENU button labelled [MIDI], as shown in the following example:

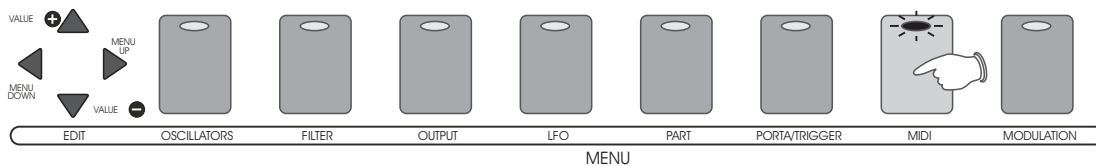

The indicator in the [MIDI] button will light and the main display will show the first function which is:

1: MIDI CHANNEL

This function allows you to set the MIDI transmit/receive channel for the selected PART. The front panel controls will transmit MIDI controller data on the selected channel. With the first menu function selected the main display will alternate as follows:

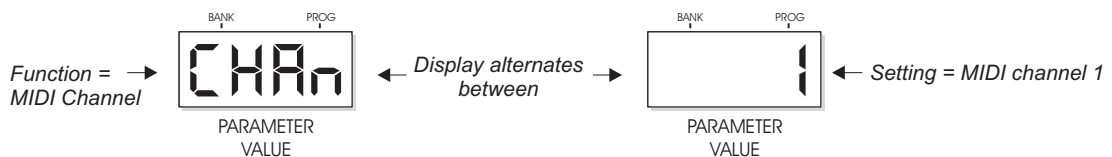

RANGE = MIDI channel 1 to 16

Use the menu [EDIT - VALUE + and VALUE -] buttons to change the setting as follows:

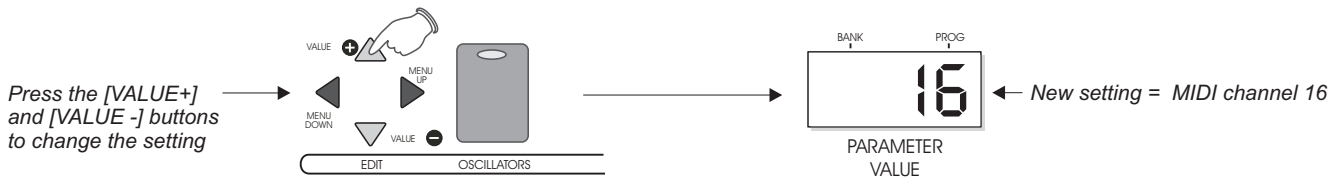

2: SUSTAIN

This function allows you to apply MIDI sustain to the selected PART. With the second menu function selected the main display will alternate as follows:

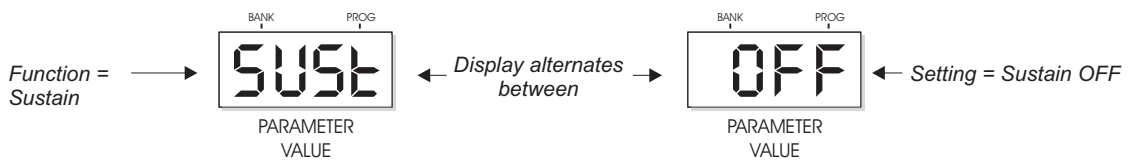

RANGE = Off and On

Use the menu [EDIT - VALUE + and VALUE -] buttons to change the setting as follows:



3: PITCH BEND RANGE

This function allows you to set the effective range of a controller keyboard's Pitch Bend wheel when used to 'bend' the selected PART. With the third menu function selected the main display will alternate as follows:

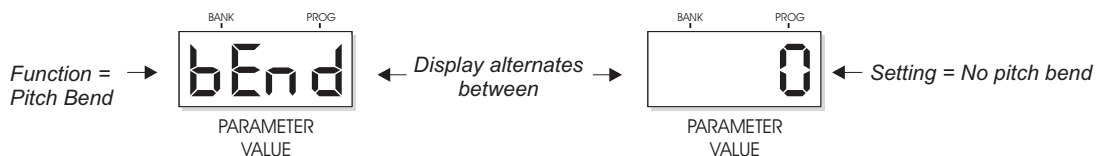

RANGE = 0 to 12 (1 octave)

Use the menu [EDIT - VALUE + and VALUE -] buttons to change the setting as follows:



OPERATION

PART OUTPUT button/knobs

This section contains further functions for PART editing. To access, press the [PART OUTPUT] button, as shown in the following example:

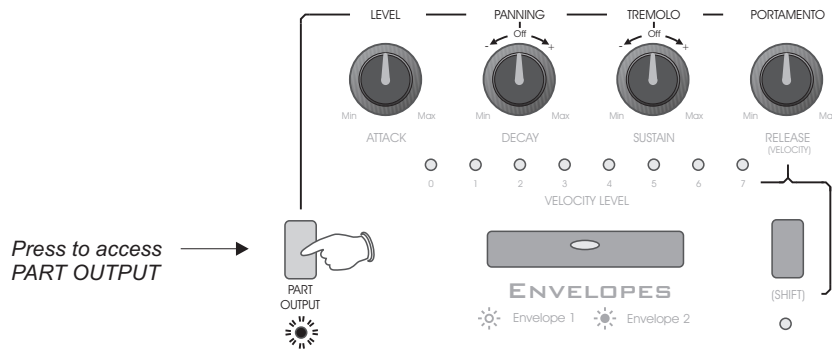

The indicator below the [PART OUTPUT] button will flash to indicate this mode is active.

CAUTION! as these controls are shared with the ENVELOPE section care must be taken to check the status of the PART OUTPUT indicator before attempting to make any changes to the associated parameters.

LEVEL

This control sets the relative output LEVEL for the selected PART. At the fully anti-clockwise position there will be no sound. As the control is moved in a clockwise direction the level will be gradually increased until, at the fully clockwise position, the output level will be at its maximum. The main display will show the volume level setting from 0 to 127(max) when this control is moved.

PANNING

This control sets the amount of PANNING effect for the selected PART. At the 12 o'clock position there will be no panning effect. As the knob is moved in an anti-clockwise direction the panning effect will be applied more and more, with initial emphasis to the LEFT channel. As the knob is moved in a clockwise direction from the centre position the panning effect will be applied more and more, with initial emphasis to the RIGHT channel.

The source for modulating the panning effect can be changed using a MENU function. To access the PANNING OUTPUT settings, press the MENU button labelled [OUTPUT], as shown in the following example:

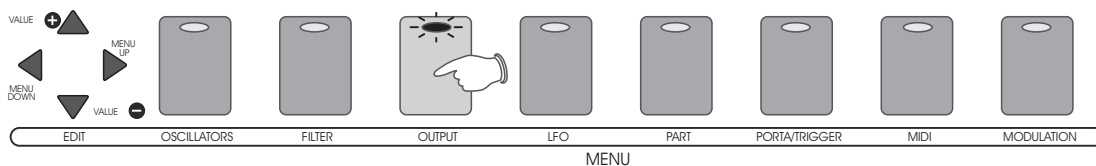

The indicator in the [OUTPUT] button will light and the main display will now alternate between the first function and its current value, as shown below:

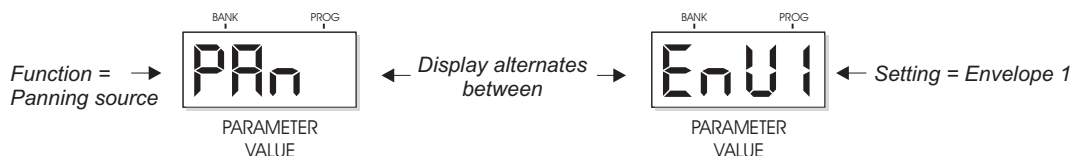

The selections are:

Pot - The PANNING knob will affect the pan position directly. Anti-clockwise = Left, clockwise = Right.

Envelope 1 - The settings of envelope 1 controls will affect the pan position.

Envelope 2 - The settings of envelope 2 controls will affect the pan position.

LFO1 - The settings of the LFO1 controls will affect the pan position.

LFO2 - The settings of the LFO2 controls will affect the pan position.

Use the menu [EDIT - VALUE + and VALUE -] buttons to change the setting as follows:



TREMOLO

This control sets the amount of TREMOLO effect for the selected PART. At the 12 o'clock position there will be no tremolo effect. As the knob is moved in an anti-clockwise direction the tremolo effect will be applied more and more in a negative manner. As the knob is moved in a clockwise direction from the centre position the tremolo effect will be applied more and more in a positive manner.

The source for modulating the tremolo effect can be changed using a MENU function. To access the TREMOLO OUTPUT settings, press the MENU button labelled [OUTPUT], as shown in the following example:

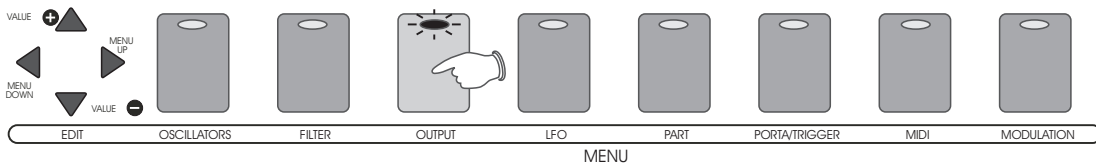

The indicator in the [OUTPUT] button will light and the main display will now alternate between the first function and its current value. Use the menu [EDIT - MENU UP] button to select the tremolo setting as follows:

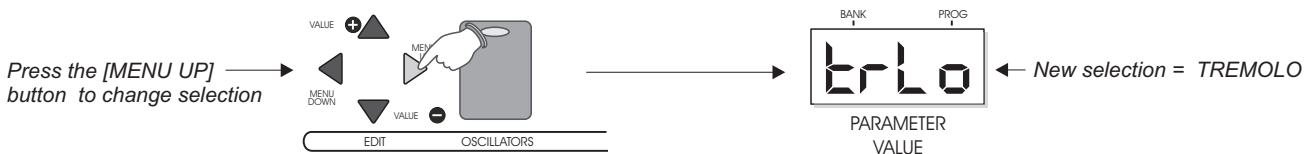

The selections are:

- LFO1** - The settings of the LFO1 controls will affect the tremolo.
- LFO2** - The settings of the LFO2 controls will affect the tremolo.

Use the menu [EDIT - VALUE + and VALUE -] buttons to change the setting as follows:

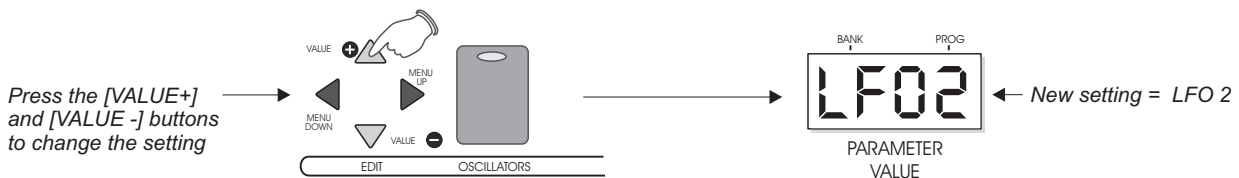

PORTAMENTO

This control sets the amount of PORTAMENTO for the selected PART. This feature changes the pitch from one note to the next creating a sliding or 'glide' effect from note to note. The CONSTANT TIME portamento featured on DARKSTAR uses a regular time period between notes regardless of how far the pitch has to travel.

At the fully anti-clockwise position there will be no portamento effect. As the control is moved in a clockwise direction the portamento level will be gradually increased until, at the fully clockwise position, the portamento effect will be at its maximum.

OPERATION

The type of portamento can be changed using a MENU function. To access the PORTAMENTO TYPE settings, press the MENU button labelled [PORTA/TRIGGER], as shown in the following example:

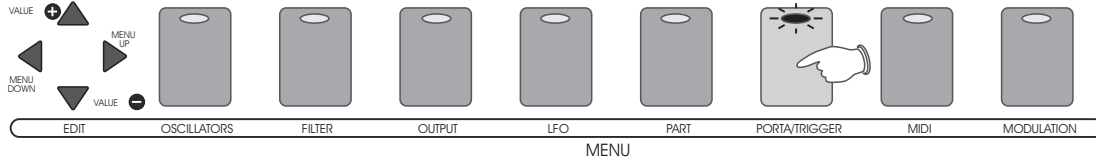

The indicator in the [PORTA/TRIGGER] button will light and the main display will now alternate between the first function (AUTOGLIDE) and its current value. Use the menu [EDIT - MENU UP] button to select the portamento setting as follows:

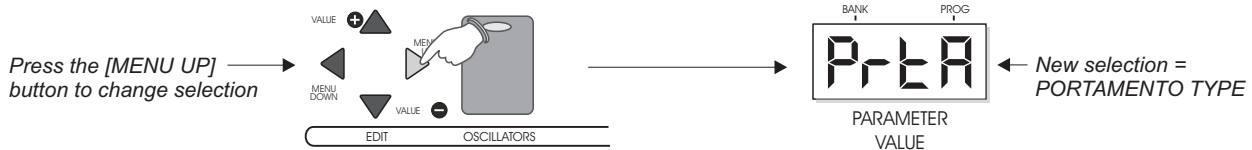

The selections are:

OFF - No portamento will be applied

Type 1 - The portamento starts from the current pitch of the last note played

Type 2 - The portamento starts from the current pitch of the voice used for the new note

Pre-glide 1 - The portamento starts 2 semitones above the note pitch

Pre-glide 2 - The portamento starts 2 semitones below the note pitch

Pre-glide 3 - The portamento starts 5 semitones above the note pitch

Pre-glide 4 - The portamento starts 5 semitones below the note pitch

Pre-glide 5 - The portamento starts 12 semitones above the note pitch

Pre-glide 6 - The portamento starts 12 semitones below the note pitch

NOTE: For monophonic parts (polyphony set to 1 voice) portamento TYPE's 1 and 2 will have the same effect.

Use the menu [EDIT - VALUE + and VALUE -] buttons to change the setting as follows:

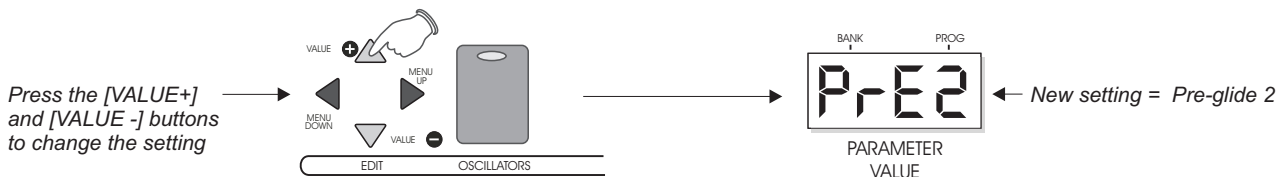

AUTO-GLIDE TRIGGERING

This function introduces a glide between notes without re-triggering the envelopes. As featured on many classic monophonic synthesizers (1 voice only), this 'guitar-style' glide occurs on DARKSTAR when a note is held down and a second note is played (if the PART polyphony is set to 1 voice). When PART polyphony is set to 2 voices, and more than 2 notes are played, the 3rd note played will 'steal' the 1st note but the envelopes will not be re-triggered. TYPE 2 portamento will be used regardless of the current portamento setting. If the 3rd note is released, the 1st note will be re-instated, again, without re-triggering the envelopes. This feature allows polyphonic auto-glide.

To setup conventional auto-glide the PART polyphony should be set to 1, AUTO-GLIDE should be ON and PORTAMENTO type should be OFF.

To access the AUTO-GLIDE function, press the MENU button labelled [PORTA/TRIGGER], as shown in the following example:

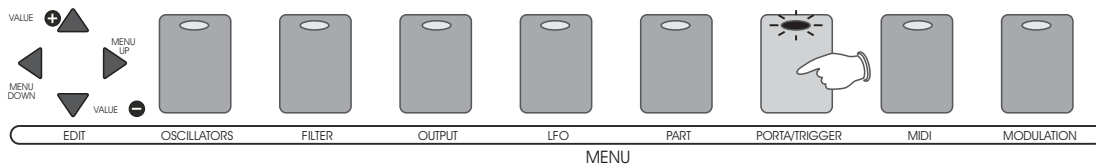

The indicator in the [PORTA/TRIGGER] button will light and the main display will now alternate between the first function and its current value, as shown below:

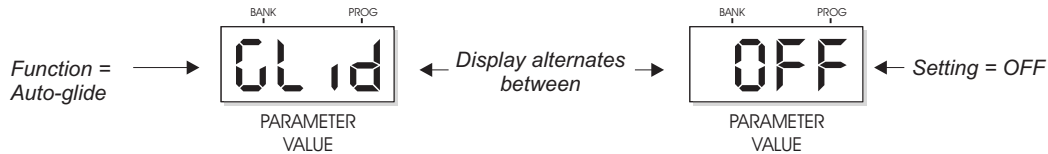

RANGE = OFF and ON:

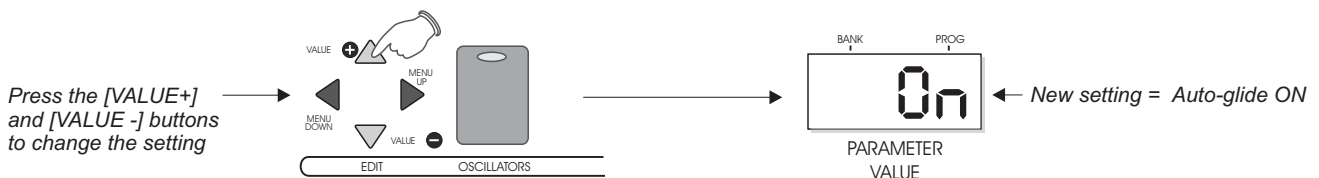

OTHER MENU FUNCTIONS

MODULATION

The MODULATION function is also contained in the [MENU] section. These settings determine the amount of depth for the MODULATION WHEEL and AFTER TOUCH MIDI controllers.

To access these settings, press the MENU button labelled [MODULATION], as shown in the following example:

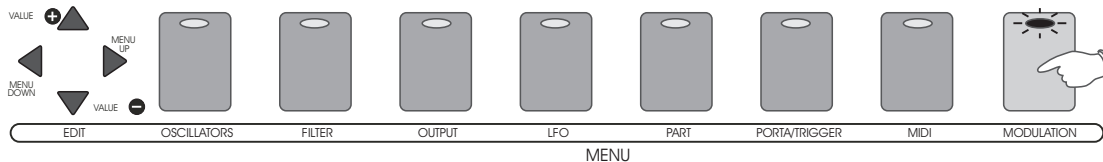

The indicator in the [MODULATION] button will light and the main display will now alternate between the first function and its current value, as shown below:

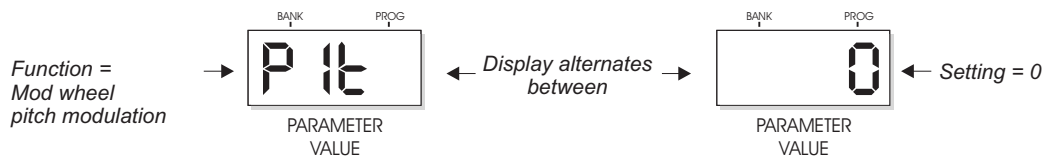

There are four functions in the MODULATION menu as follows:

1. Modulation Wheel - Pitch Mod Depth: This function allows you to set the amount of pitch modulation that will be applied when the Modulation Wheel is used. RANGE = +7 to -7. *NOTE: if pitch mod source is set to envelope 1 or 2 then the mod wheel will affect the amount of pitch envelope modulation.*

2. Modulation Wheel - Filter Mod Depth: This function allows you to set the amount of filter modulation that will be applied when the Modulation Wheel is used. RANGE = +7 to -7

3. After-Touch - Pitch Mod Depth: This function allows you to set the amount of pitch variation that will be applied when After-Touch controller data is received. RANGE = +7 to -7

4. After-touch - Filter Mod Depth: This function allows you to set the amount of filter variation that will be applied when After-Touch controller data is received. RANGE = +7 to -7

Use the menu [EDIT - VALUE + and VALUE -] buttons to change the setting as follows:



To select a different menu function, use the [MENU UP and [MENU DOWN] buttons.

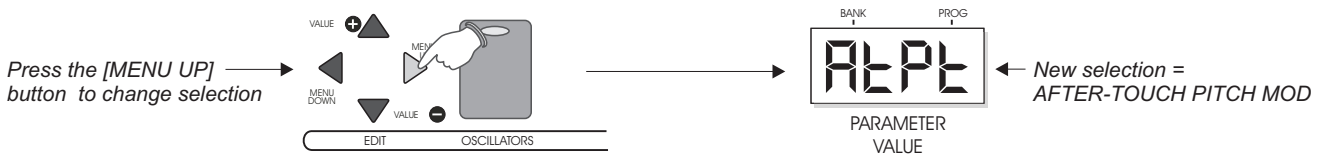

To EXIT modulation menu mode, simply press the [MODULATION] MENU button and check that the indicator goes out.

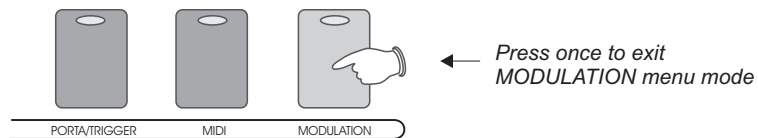

PART COPYING: This feature allows you to transfer all parameter data (except the polyphony setting) from one PART to another at the press of a button. As an example, if you create a great sound on PART 1, you can easily copy this sound in its entirety to any number of other PARTS in the same program. By using the same MIDI channel and note ranges for all PARTS the oscillators will sound simultaneously (in 'unison') when a note is struck. PART copying is also useful for making new sounds from the basis of an original.

To copy a PART, first *press and hold down* the currently selected [PART] button (LED will flash), as shown in the following example:

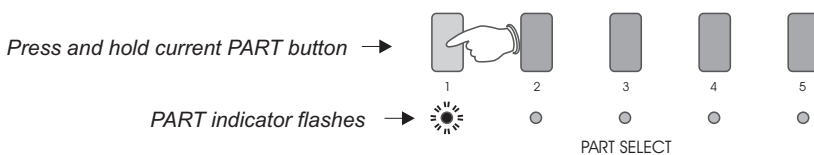

Now press the [PART] button which coincides with the desired destination, as shown below:

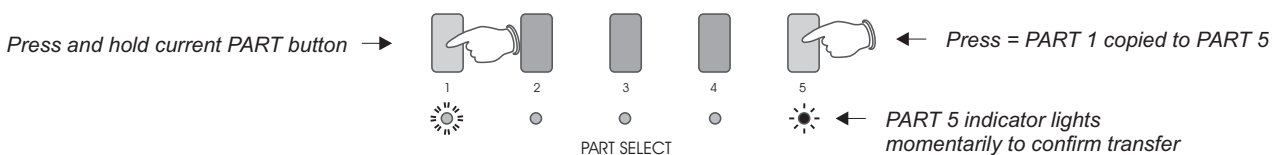

After copying, the original PART will still be selected. You can repeat this operation for other PARTS until the polyphony is used up. Remember to save the program after editing has been completed.

PROGRAMS

This feature allows you to store all the DARKSTAR settings in memory for instant recall of your favourite sounds. The position of every knob, switch and even the joystick position can be memorised in 64 user definable program memories.

The [MENU] buttons are used to recall, compare and store the programs. To enter program mode, press *and hold down* the [PROGRAM] button (indicator ON), as in the following example:

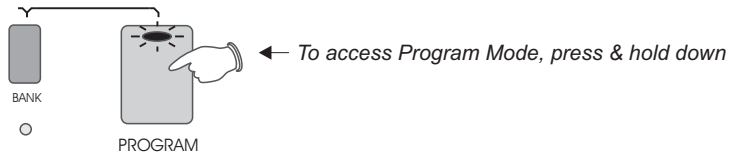

NOTE: The functions within program mode can only be accessed whilst the [PROGRAM] button is held down. The labelling above each button designates the program number from 1 to 8.

RECALL: To recall a program, press any of the [PROG] buttons whilst holding down the [PROGRAM] button, as in the following example:

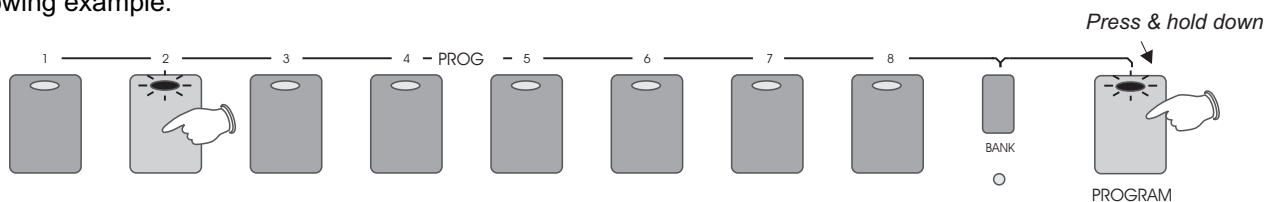

The main display will indicate the new setting, as shown in the following example:

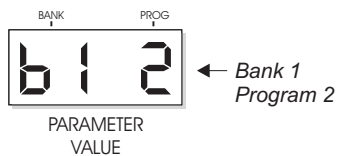

DARKSTAR features a total of 64 programs that are grouped into 8 banks of 8 programs. To access the other 7 BANKS, press the [BANK] button (*whilst holding down the [PROGRAM] button*) and then press the required BANK number, as shown in the following example:

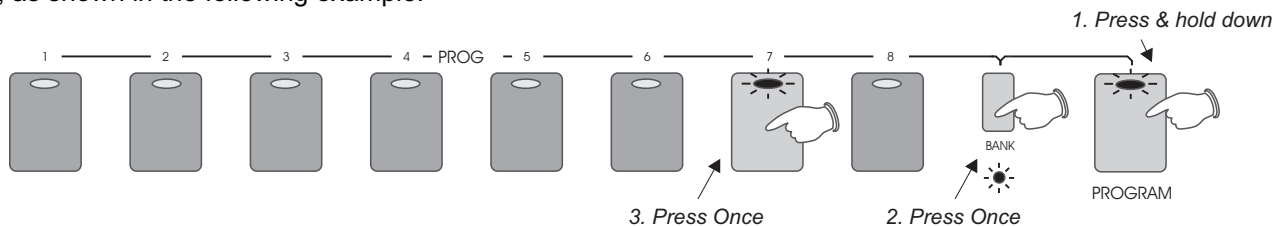

As soon as the numbered button is pressed the new BANK will be recalled. The indicators for the [BANK] button and selected BANK number button (example= 7) will go out and the last selected PROGRAM in that BANK will be automatically recalled. The main display will indicate the new setting, as shown in the following example:

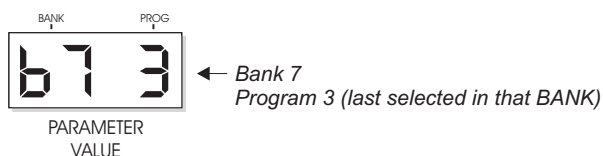

EDITING: To edit the selected program simply adjust the controls. When the first control or switch is moved, the [EDIT] indicators (and the selected program button indicator) will start to flash to indicate 'EDIT' mode, as shown in the following example:

OPERATION

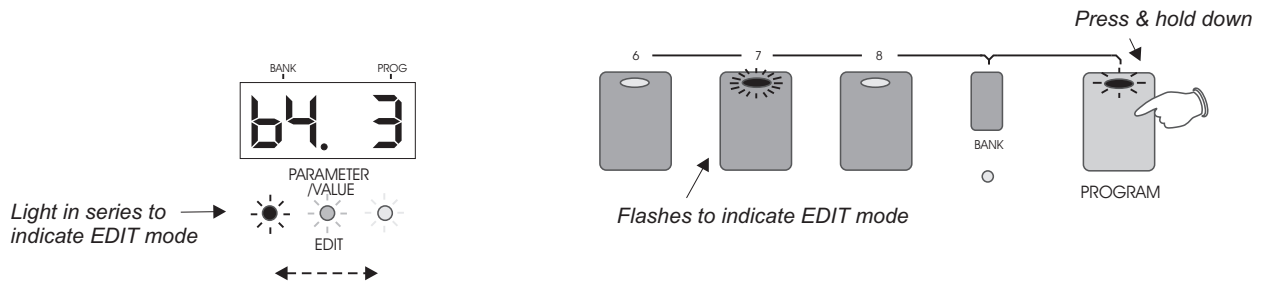

If you *don't* want to keep the parameter changes made during editing, simply select another program number.

COMPARE: To hear the ORIGINAL settings of the selected program, press and hold down the [PROGRAM] button, then press the flashing program button once. The indicator in the selected program button will now flash at twice the rate to indicate 'Compare' mode, the PART setup reverting back temporarily to the pre-edit condition. You can switch from 'Edit' to 'Compare' modes as often as you like, simply press the button again to jump from one mode to the next.

STORE IN SELECTED PROGRAM: If you want to store the new settings, they can be saved into the selected program (any previous settings will be overwritten). To store the new settings, press and hold down the selected program button (whilst holding down the [PROGRAM] button) for approximately 2 seconds. The indicator in the program button will flash rapidly and 'SAVE' will appear briefly in the main display whilst the store operation is carried out.

STORE IN ANOTHER PROGRAM: If you want to keep the existing program *and still save* the edited setup, you can store it in any of the other program/bank locations. First press and hold down the [PROGRAM] button and then select another program number, KEEP THE [PROGRAM] BUTTON HELD DOWN and then press the new program button a second time. The previously edited setup will now be recalled into this program buffer. If you are happy to overwrite the program, press and hold down the selected program button (whilst still holding down the [PROGRAM] button) for approximately 2 seconds. The indicator in the program button will flash rapidly and 'SAVE' will appear briefly in the main display whilst the store operation is carried out.

STORE IN ANOTHER BANK: If you want to store the edited sound in a different BANK altogether, press and hold down the [PROGRAM] button and then press the [BANK] button once. KEEPING THE [PROGRAM] BUTTON HELD DOWN AT ALL TIMES select the program number you wish to overwrite. The previously edited setup will be recalled into the program buffer of the new bank. If you are happy to overwrite the program, press and hold down the selected program button (whilst still holding down the [PROGRAM] button) for approximately 2 seconds. The indicator in the program button will flash rapidly and 'SAVE' will appear briefly in the main display whilst the store operation is carried out.

You can try any amount of program locations before saving the new setup by repeating this procedure. To exit PROGRAM mode at any time simply release the [PROGRAM] button (LED off).

The 64 factory presets can be re-loaded back into memory at any time.

RE-LOAD ALL 64 FACTORY PRESETS: Ensure power is switched OFF. Press and hold down the [PROGRAM] button and then turn power on. The main display will show 'SURE' to prompt confirmation of the load. Press the MENU [EDIT] button marked 'VALUE +' to confirm the operation ('LOAD' appears briefly in display).

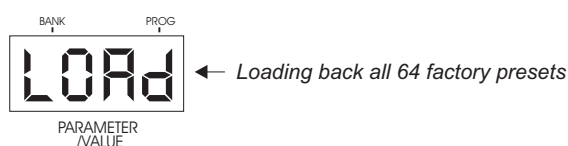

EXTERNAL INPUTS

This feature allows you to process external MIDI driven audio signals through the Filter and Envelope sections of DARKSTAR. Connect the audio output of your MIDI synthesizer/guitar etc. to one of the rear panel sockets marked [EXT INPUT].

The bi-colour 'LEVEL' indicator at the top edge of the front panel monitors the input signal level. This indicator shows three input level conditions as follows:

- OFF - No signal or very low signal level
- BRIGHT GREEN - Normal line level signal present - **Ideal working level**
- RED - Overloaded signal - Level too high

This indicator should be normally illuminated GREEN, occasionally flashing RED. If the level indication is incorrect, adjust the output level on the external sound source accordingly.

NOTE: if the input signal level is set incorrectly the audio quality may be affected.

Connect the MIDI OUT socket from your MIDI device to the MIDI IN on DARKSTAR, as detailed in the following diagram:

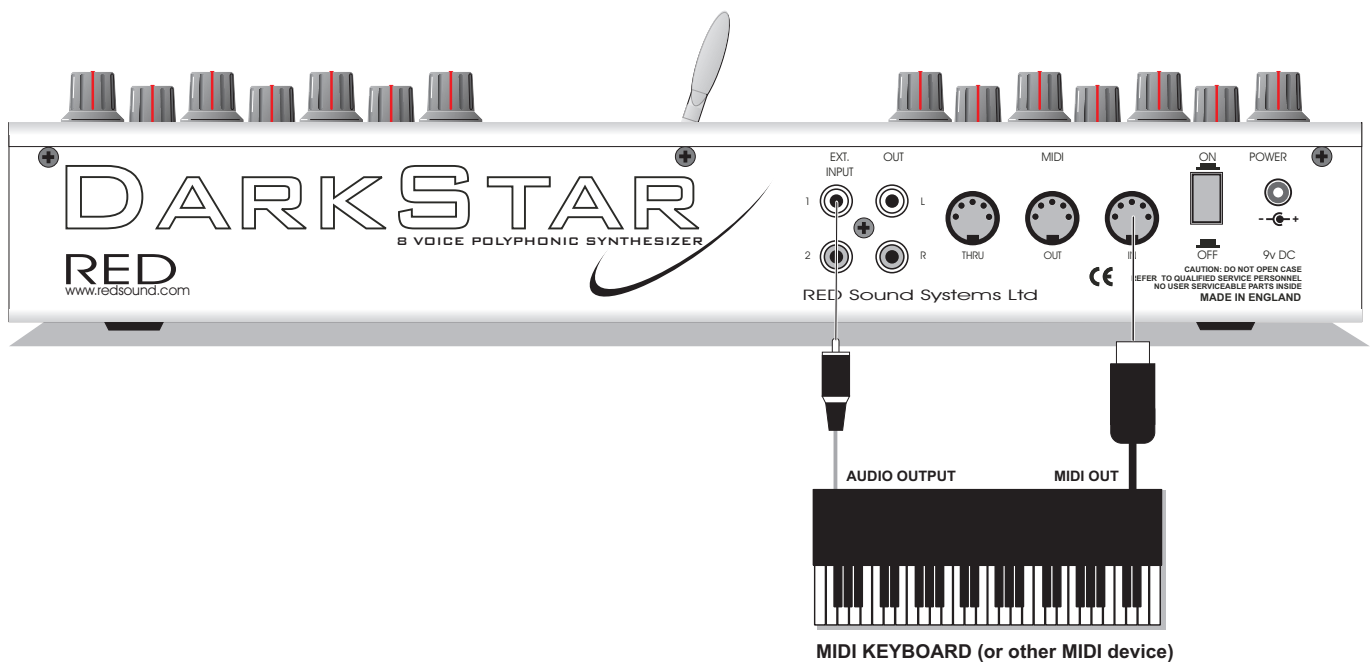

Using the [OSCILLATOR] menu function (see page 9 for further details), set oscillator 2 source to 'IN-1'. Move the [MIXER] joystick over to the lower left position and play some notes on the external instrument. You should only hear the sound from the external sound source through the filter and envelopes. Use the joystick to mix oscillator 1 and ring modulation in with the external input for a combined effect.

MIDI CONTROLLERS

DARKSTAR's comprehensive MIDI specification allows you to record and playback changes to the front panel knobs/switches in real-time. This extensive power and control over these parameters will allow you to explore new areas of creativity in the studio. Whenever a control knob is turned, the joystick moved or a button pressed, MIDI controller data will be transmitted from the MIDI OUT socket directly into your MIDI sequencer allowing you to record detailed parameter changes for instant, automated playback. You can record simple, 'one-shot' parameter changes or over-dub as many as you like to build up complex, multi-layered sound scenarios.

Example: To record these events, first ensure your MIDI sequencer is connected to the MIDI In/Out sockets on the rear panel of DARKSTAR as detailed on page 6. Check the MIDI transmit/recieve channels on the sequencer's record channel match those on DARKSTAR and when you're ready, press RECORD on the sequencer. Whilst the sequencer is recording, move any knobs/switches to transmit the MIDI data. When you're happy with the control changes, STOP the sequencer. Now reset the MIDI sequence to the beginning and press PLAY to hear the changes re-played precisely as you recorded them. See the MIDI implementation chart at the end of this booklet for detailed MIDI controller information.

UTILITY MODE

The Utility section contains MIDI System Exclusive functions for saving programs to an external MIDI device. Using 'sysex' dumps you can create an unlimited library of sounds and programs for instant recall at any time.

To enter utility mode, press the [UTILITY] button once, as in the following example:



UTILITY



← Indicator on = Utility mode

The parameters in utility mode are as follows:

UTILITY 1: PROTECT ON/OFF

This is where you enable DARKSTAR to overwrite existing programs. System exclusive bulk dump messages from an external MIDI storage device can only be received and stored in memory when the protect is set to OFF. With utility mode '1' selected, the display will alternate between:

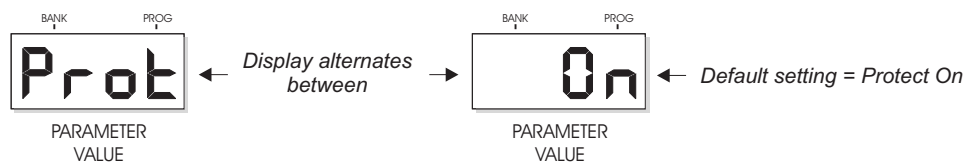

Use the menu [EDIT - VALUE + and VALUE -] buttons to change the setting as follows:



SYSTEM EXCLUSIVE RECEIVE:

VOICE - The received VOICE will be loaded into the current PART of the selected PROGRAM but never saved, regardless of PROTECT setting. MIDI channel and POLYPHONY values will be retained from original voice.

SINGLE PROGRAM - The received PROGRAM will be loaded into the current PROGRAM and, if PROTECT is OFF, it will be saved. If PROTECT is ON, the program will be 'held' in buffer memory, just like an edited program, allowing you to use the sounds in real-time or store wherever you choose at a later stage.

You can use the buffer memory to receive multiple sys-ex dumps 'on-the-fly' from your MIDI sequencer as a track plays from beginning to end. When power is switched off, data in the buffer memory will be lost.

ALL PROGRAMS (1-32 or 33-64) - If PROTECT is ON, these system exclusive messages will be ignored. If PROTECT is OFF, the PROGRAMS will be stored in memory before being saved. The display will show the current save program as it is downloaded, as shown in the following example:

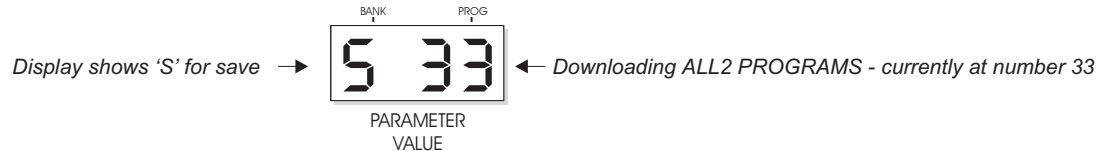

NOTE: Whilst this process is happening it is important not to send any other system exclusive messages to DARKSTAR.

UTILITY 2: SAVE PART VOICE

This feature allows you to save individual sounds from within each PART. You can quickly recall these sounds into buffer memory during a performance for 'on-the-fly' patch changes. These voices cannot be saved directly into memory but can be saved into the program once loaded by carrying out a 'save program' procedure. Use the menu [EDIT - MENU UP] button to select this feature. With utility mode '2' selected, the display will alternate between:

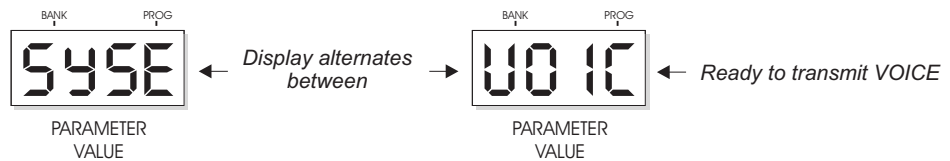

Ensure the connected MIDI storage device is ready to receive the data. Use the menu [EDIT VALUE + or VALUE -] button to transmit the voice, as shown in the following example:

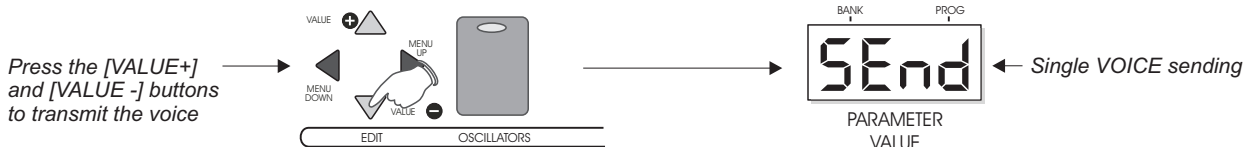

The display will show 'SEnt' after the transmission.

UTILITY 3: SAVE PROGRAM

This feature allows you to save any of the 64 PROGRAMS individually. The transmitted program will be the one selected prior to entering UTILITY mode. Use the menu [EDIT - MENU UP] button to select this feature. With utility mode '3' selected, the display will alternate between:

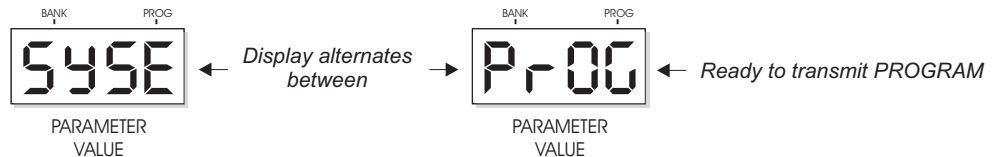

Ensure the connected MIDI storage device is ready to receive the data. Use the menu [EDIT VALUE + or VALUE -] button to transmit the program, as shown in the following example:

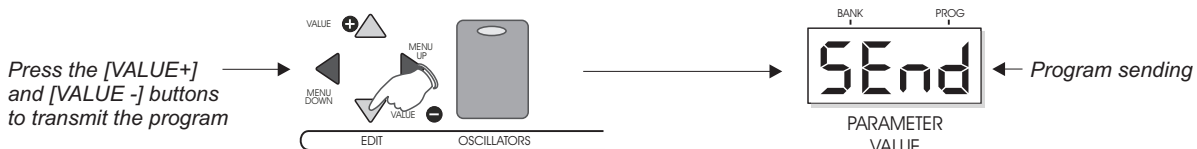

UTILITY 4: SAVE ALL PROGRAMS (1 - 32)

This feature allows you to save the *lower* group of 32 PROGRAMS together as one sysex dump. Use the menu [EDIT - MENU UP] button to select this feature. With utility mode '4' selected, the display will alternate between:

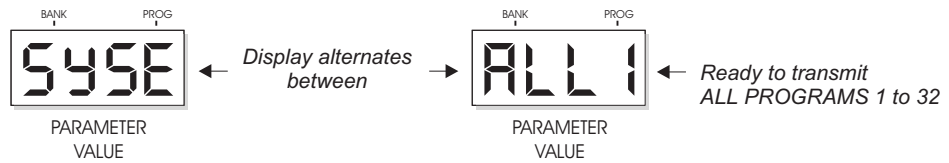

Ensure the connected MIDI storage device is ready to receive the data. Use the menu [EDIT VALUE + or VALUE -] button to transmit the program, as shown in the following example:

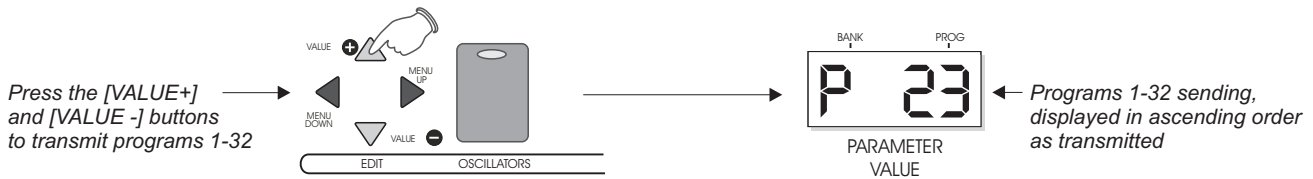

The main display counts up the program numbers (1, 2, 3...) as they are transmitted. When all 32 programs have been transmitted the display will show 'SEnt' briefly to confirm completion.

UTILITY 5: SAVE ALL PROGRAMS (33 - 64)

This feature allows you to save the *upper* group of 32 PROGRAMS together as one sysex dump. Use the menu [EDIT - MENU UP] button to select this feature. With utility mode '5' selected, the display will alternate between:

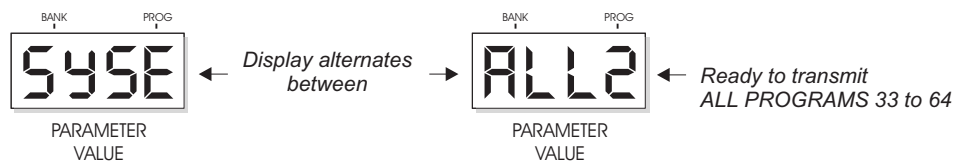

Ensure the connected MIDI storage device is ready to receive the data. Use the menu [EDIT VALUE + or VALUE -] button to transmit the program, as shown in the following example:

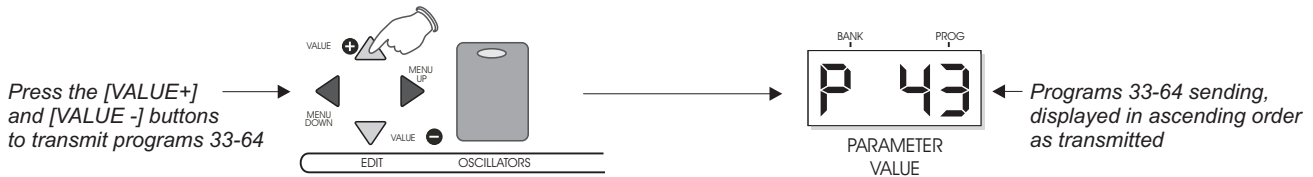

The main display counts up the program numbers (33, 34, 35...) as they are transmitted. When all 32 programs have been transmitted the display will show 'SEnt' briefly to confirm completion.

NOTE: Ensure the PROTECT feature is set to ON (or disconnect the MIDI IN) before attempting to save programs. This will avoid sys-ex data from the save transmission coming straight back into DARKSTAR which could result in irregularities to the program data.

TROUBLESHOOTING

Problem
No Power

Check
Check power supply connection
Check internal program EPROM is fitted correctly (inside access panel)

No sound

Check PART level
Filter Frequency or Decay/Sustain levels set to zero
Osc 2 set to External input with no source connected
Envelope 1 Attack time set to maximum

DARKSTAR - ACCESSORIES

For conveniently mounting DARKSTAR in any 19" rack environment there is a custom rack kit available: **RACK-02**



Complete with all fixings and EXTERNAL INPUT extension socket/lead to allow instant access to input connections once DARKSTAR is installed. Please ask your dealer / distributor for availability.

UPGRADING DARKSTAR

When you purchase an upgrade kit for DARKSTAR you will need to change the program EPROM chip inside the product. The access panel is situated on the rear panel. To open, remove the single fixing screw and lift out the panel taking care to not lose any of the parts or drop any objects inside the main casing. Follow the instructions supplied with the upgrade kit for replacing the chip safely.

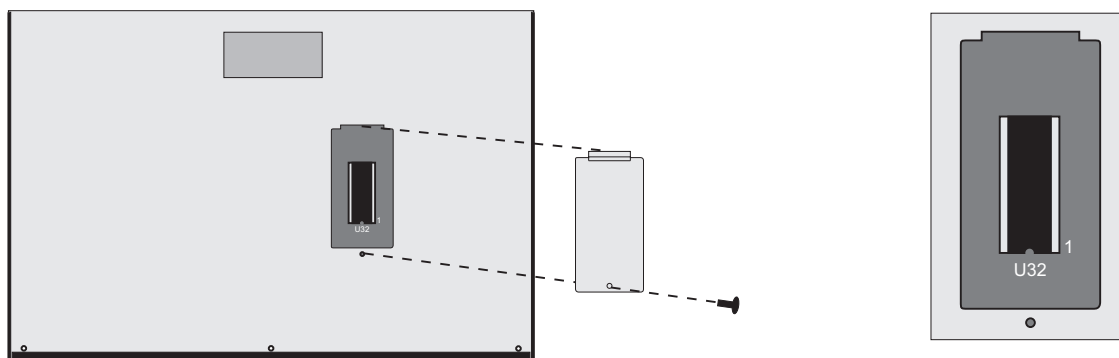

Correct chip polarity

SPECIFICATION

DARKSTAR 8-VOICE SYNTHESIZER

Polyphony: 8 Voices

Multitibral: 5 Parts

Each part features: *Level, Transpose and Note range setting. Tremolo effect modulated from one LFO. Pan effect modulated from one LFO or Envelope.*

Voice Specification: 2 Oscillators

Each continuously variable between Sawtooth and square/pulse output.
Each can be de-tuned and can be modulated by one of the envelopes/LFOs.
For each the pulse width can be varied and modulated by one of the envelopes/LFOs.
Oscillator 2 can be transposed 5, 7, 12, 16, 17, 19 or 24 semitones.
Oscillator 2 can be switched between: *Normal, Formant wave, Pink noise, White noise, Blue noise, Input 1, Input 2.*

Mixer: X/Y Joystick (X axis = oscillator mix, Y axis = Ring Modulation)

Filter: 12dB per octave resonant

The cut-off frequency can be modulated by the LFO or envelope and set to track the keyboard.
The resonance can be varied and modulated by one of the envelopes or LFOs.
The output can be switched between off, low pass, band pass and high pass.

Envelopes: 2 x ADSR envelopes, each of which can be set to respond to key velocity

LFOs: 2 x LFOs, each with a separate speed and delay control.

Each LFO can be set to output one of the following waveforms: *Ramp, Triangle, Square, Sine, Pulse, Sample & hold, Random*
Each can be set to key sync.
Each can be synced to incoming MIDI clock.

Triggering/Port'mto: Note triggering can be normal or autoglide

Polyphonic portamento for polyphonic parts.
Portamento has constant time, two polyphonic modes and six pre-glide modes.

MIDI:

Note ON/OFF, Velocity, Pitch bend, Mod wheel / aftertouch (assignable), Program change, Sustain pedal, most parameter controls, System exclusive.

Power Supply: External (9vDC 800mA minimum) output plug wired centre pin +.

Dimensions/Weight: 340x230x50mm (13.4x9x2 inches) 2.35kg

Optional Accessories: Rack-02 (19" rack kit with extension lead to External inputs)

Function		Transmitted	Recognized	Remarks
Basic Channel	Default Changed	1-16 1-16	1-16 1-16	Memorized
Mode	Default Messages Altered		Mode 3	
Note Number:	True Voice	X	O	
Velocity	Note ON Note OFF	X X	O X	
Aftertouch	Key's Ch's	X X	X O	
Pitch Bend		X	O	
Control Change	1	X	O	Mod Wheel
	7	O	O	Part Volume
	10	O	O	Panning
	29	O	O	Tremolo
	30	O	O	Mixer joystick 'X' (left/right)
	31	O	O	Mixer joystick 'Y' (up/down)
	35	O	O	Filter Frequency
	36	O	O	Filter LFO Modulation
	37	O	O	Filter Envelope Modulation
	38	O	O	Filter Resonance
	39	O	O	Filter Resonance Modulation
	43	O	O	Envelope 1 Attack
	44	O	O	Envelope 1 Decay
	45	O	O	Envelope 1 Sustain
	46	O	O	Envelope 1 Release
	47	O	O	Envelope 2 Attack
	48	O	O	Envelope 2 Decay
	49	O	O	Envelope 2 Sustain
	50	O	O	Envelope 2 Release
	51	O	O	LFO 1 Speed
	52	O	O	LFO 1 Delay
	53	O	O	LFO 1 Shape
	54	O	O	LFO 1 Midi
	55	O	O	LFO 2 Speed
	56	O	O	LFO 2 Delay
	57	O	O	LFO 2 Shape
58	O	O	LFO 2 Midi	
64	X	O	Sustain	
70	O	O	Oscillator 1 Detune	
71	O	O	Oscillator 2 Detune	
72	O	O	Oscillator 1 Pitch Modulation	
73	O	O	Oscillator 2 Pitch Modulation	
74	O	O	Oscillator 1 Pulse Width	
75	O	O	Oscillator 2 Pulse Width	
76	O	O	Oscillator 1 Pulse Width Modulation	
77	O	O	Oscillator 2 Pulse Width Modulation	
78	O	O	Oscillator 1 Waveform	
79	O	O	Oscillator 2 Waveform	
Program Change	True #	O 0 - 63	O 0 - 63	Program No. 1- 64 On Master Channel.
System Exclusive		O	O	
System Real Time	Clock Commands	X	O	Clock, Start.
Aux Messages	:All sound off :Reset all controllers :Local ON/OFF :All Notes OFF :Active sense :System Reset	X X X X X X	X X X X X X	
Mode 1 : OMNI ON, POLY Mode 2 : OMNI OFF, POLY		Mode 3 : OMNI ON, MONO Mode 4 : OMNI OFF, MONO		