

A - S T A T I O N



A•station

polyphonic synthesizer

▲ User Manual

 **novation**
in music, anything is possible.

*Copyright: Novation E.M.S Limited 2001 A-Station User Guide
Version 1.1*

*Features and specifications subject to change without notice due
to improvements*

Table of Contents

Introduction	1	Chorus, Phaser.....	29
Using this manual.....	2	Distortion.....	30
Main Features.....	2	Panning.....	31
Conventions used in this manual.....	3	EQ Filter.....	32
Quick Start Guide	4	Vocoder.....	34
Connecting to audio equipment.....	4	Other Menus	36
Listening to the factory preset sounds.....	4	Arpeggiator.....	36
Selecting sounds.....	4	Oscillators.....	40
Auditioning a sound.....	5	Oscillators - FM synthesis.....	41
Editing a sound.....	5	Pitch and Modulation wheels.....	44
Saving a sound.....	6	Aftertouch and Breath Control.....	46
Listening to the factory demonstration.....	7	Velocity, Triggering and Synchronisation.....	47
Synthesis Tutorial	8	Utility Mode	52
Elements of a sound.....	8	Global Master tuning - Local On / Off.....	52
Oscillators and Waveforms.....	9	Global Midi clock - Midi sync.....	53
Mixer and Filter.....	10	Global Velocity Curve, Display operation, Ext Audio Input.....	54
Envelopes and Amplifier.....	11	Saving (backing up) sounds to an external device.....	56
LFOs and Memories.....	12	Loading (restoring) factory preset sounds.....	56
Summary.....	13	Receiving sounds from an external device.....	57
Main features and operation	14	Connection diagram.....	58
Volume, Portamento controls ,Function Switch and LED.....	14	Notes.....MIDI Volume... Sustain Pedal.....	59
Mode select button.....	15	Appendix	A1
Oscillators.....	16	Factory Preset Sounds Listings and Examples.....	A1
Mixer.....	19	Operating System Upgrade Process.....	A3
Filter.....	20	Technical Specification.....	A4
Amp and Mod Envelopes.....	22	MIDI Controller List.....	A5
LFO's.....	23	MIDI NRPN List.....	A8
Advanced features	24	Packed Controller / NRPN Details.....	A9
Effects	24	MIDI System Exclusive	A10
Delay.....	24	MIDI Implementation Chart.....	A16
Reverb.....	28	Menu Lists.....	A17
		FCC Information.....	A20

Using this Manual - Main Features

Thank you for purchasing the Novation A-Station Synthesizer.

This polyphonic sound module has evolved from the classic Novation Bass Station, using the very latest Novation technology from award winning products such as the Nova and SuperNovall. It is capable of producing an enormous range of high quality synthesized sounds and is an ideal machine for a home studio set-up or for an experienced producer looking to add an extra dimension of controllable sound power.

Using this Manual

This manual consists of four chapters, **Introduction, Quick Start Guide, Main Features and Operation, and Advanced Features**. For easy reference, the chapter name is printed in the footer margin of each page. An **Appendix** on the final pages lists all menu options and factory preset sounds list.

In order to become an expert user as quickly as possible, it is recommended that this manual is read in sequence chapter by chapter. If sound synthesis is an unfamiliar subject, then the chapter 'About Analogue synthesis' will provide a useful introduction to the techniques used to electronically simulate the sound of a musical instrument using an analogue music synthesizer.

If the general principles of Sound Synthesis are already familiar, then the Quick Start Guide is the place to begin. Once familiar with the main features of the machine, the Advanced Features section which covers the Effects, Arpeggiator, Synchronisation, Triggering and the Utilities, will provide all the information to operate the A-Station in the most creative, productive way.

Main Features

* **Four hundred Program sound locations**

Two hundred factory programmed sounds are included and a further two hundred user sound memory locations are provided (the two hundred factory sounds may be overwritten).

* **Powerful Oscillators**

Three Oscillators provide Sawtooth, Square, Variable Pulse, Triangle and Sine waves. The Sawtooth, Triangle and Sine waveforms may be duplicated within an Oscillator to provide thicker sounding waveforms. Synchronization and FM between two Oscillators allow the generation of metallic or percussive timbres. A white noise source completes the waveform engine.

* **External Audio Input**

The Mixer allows an external audio signal to be combined with the Oscillators and processed through the Filter and Envelopes. Envelopes may then be auto-triggered by the external signal.

* **Filter**

The filter in the A-Station Synthesizer delivers the liquid sound of an analogue filter. Selectable Low-pass, 12dB or 24dB cut-off curves with Resonance, Overdrive and Resonance normalize make it easy to faithfully recreate anything from distorted rave screams to tightly rounded bass patches.

* **Vocoder**

The 12 band Vocoder makes it easy to create Robot and Talky sound effects.

* **Arpeggiator**

The arpeggiator features six different pattern types with adjustable gate time for staccato effects.

* **Comprehensive MIDI control spec**

Adjustments of any controls transmit MIDI Controller numbers for real time recording by a sequencer or computer.

* **Powerful Effects**

The effects processor includes Distortion, Stereo Chorus, Phaser, Reverb, Synchronized Delay and Synchronized Stereo Panning. Complex, dynamic timbres may be created using tempo synchronized effects settings. A final output EQ and Filter section complete with a tempo synchronized LFO allow for a performance to be automatically filtered and time locked from 32nd triplets through to several bars.

Conventions used in this Manual.

The word 'Program' refers to a collection of knob and switch settings that define an individual 'Sound'. These settings are then saved as a 'Program' that has a corresponding number in the machines non volatile memory.

Throughout this manual the two words, 'Sound' and 'Program' are frequently referred to and essentially have the same meaning.

Text in CAPITALS refer to a front panel control or legend (even though the name of the control may be in lower case on the

actual front panel). It could be a knob or button. For example FREQUENCY refers to the Filter frequency control knob. MODE select refers to the mode select button.

Warning Mode

If for any reason the front panel switches are set to an undetermined position (mid way between one setting and another) the display will alert the condition by flashing the following sequence



Should this occur, simply locate the switch that is mid position and move it left or right.

Connecting to audio equipment - Listening to factory preset sounds - Selecting sounds

The fastest way to become familiar with the A-Station is to follow this quick start guide. It covers connecting up the A-Station, listening to the factory preset sounds, selecting sounds, editing a sound and saving a sound.

Connecting to audio equipment

Before connecting the A-Station to other units in the system, ensure the power to all units is off. Connect an audio cable from the Left and Right master output sockets to a suitable amplifier or mixing desk stereo inputs. If the A-Station is to be operated in MONO, either output may be used.

Connect the MIDI Out from a master keyboard or sequencer to the MIDI In on the A-Station. Connect the power supply (Novation PSU-6) to the socket 'Power In 9VDC' and connect the adapter to the AC mains. Switch on the power. The A-Station front panel LED display will now display the last selected program number. Switch on other units in the Audio system.

Listening to the factory preset sounds

Ensure the FUNCTION switch is set to NORMAL. Set the VOLUME control to a reasonably high output level. This will maintain a good signal to noise ratio. Make sure that the input volume setting on the system amplifier or mixer is initially set to zero.

The A-Station is set at the factory to receive on MIDI channel 1, so ensure the keyboard or sequencer is set to transmit on this channel. Play the master keyboard or sequencer and the currently selected factory preset sound will be heard.

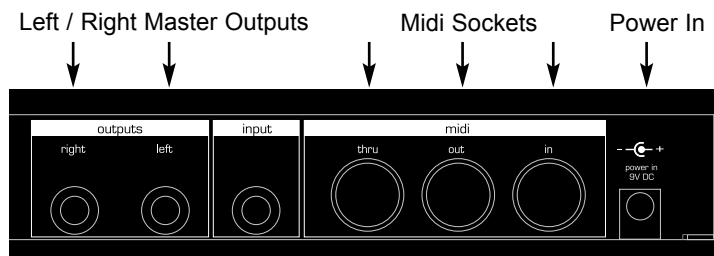

Rear Panel

Selecting Sounds

There are three ways to step through the factory preset sounds.

PROGRAM mode must be selected (the Program LED is lit or flashing). If necessary press the MODE button until it is.

There are 4 banks of 100 sounds in the A-Station named Bank 1, 2, 3 and 4

- Bank 1 100 - 199 - First bank of factory preset sounds
- Bank 2 200 - 299 - Second bank of factory preset sounds
- Bank 3 300 - 399 - First bank of user sounds
- Bank 4 400 - 499 - Second bank of user sounds

1 - Using the 0 - 9 Keypad

Ensure the FUNCTION button is set to NORMAL. There must always be a three digit entry on the numeric keypad, for example: To select Bank 1 sound 8, press the **1**, **0** and **8** buttons. The display reads **08** and the PROGRAM LED will blink continuously indicating that the selected program is from Bank 1;

To select a program in Bank 2, sound 17, press the **2**, **1** and **7** buttons, the display reads 17 and the program LED will blink twice continuously indicating that the selected program is from Bank 2; Selecting Bank 3 or 4 with a three digit entry will cause the PROGRAM LED to blink three and four times respectively.

2 - Using the + / - Keypad buttons

Use the **+** and **-** buttons to move up or down to the next program. Pressing and holding either button for a short period will cause the program number to advance by a further 9. This is useful for auditioning factory preset sounds that are set ten locations apart. For example Bass type sounds are at 100, 110, 120 etc.

3 - Using MIDI Program Change Commands

A MIDI Program change or Bank Change command sent from an external sequencer or controller keyboard will select the appropriate Program or Bank Number.

Auditioning a sound

As well as responding to MIDI commands from a keyboard or sequencer, the sounds in the A-Station may be triggered or Auditioned by pressing the AUDITION button. Each press of the button will sequence through a selection of notes to give a clear indication of the sound at different pitches.

Editing a Sound

Once familiar with the sounds that are available, select program number 499. This is a very basic synthesizer sound. It can be used as a starting point to create a new, more interesting

sound. When this sound is played from the keyboard, it will be noticed that there is no change to the volume of the sound other than it being on when the key is pressed, and off when the key is released. The most useful editing controls on the A-Station are on the front panel and some of these will be now be used to modify (edit) this basic program.

While playing the keyboard, adjust the Amplifier Envelope SUSTAIN control. Notice that the sound level when holding a key down changes. Set this control to just over half. Now adjust the RELEASE control. Notice how, when a key on the keyboard is released the sound will continue after the key is released.

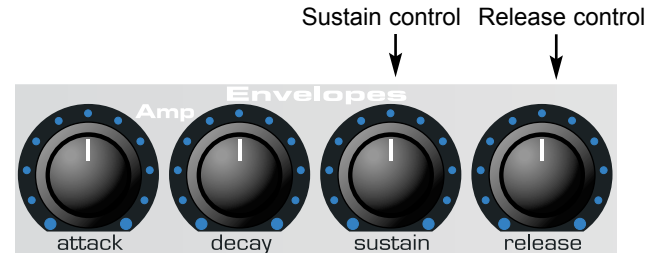

How quickly the sound dies away depends on the setting of this control. The sound is still a little too bright. Adjust the FREQUENCY control in the filter area. Notice how the sound becomes softer as the control is rotated anticlockwise. Continue to make adjustments until a desired sound is heard. The first small edit is complete on the A-Station!

The sound must now be saved if it is needed for the future.

Saving a sound

Saving a sound

Sounds may be saved in any location. It is recommend that the user locations (Banks 3 and 4, 300 - 499) be used early on for saving new sound creations. The factory preset sounds in Banks 1 and 2 may also be overwritten if desired. Once these factory presents are overwritten, they may only be retrieved by performing a factory restore - See page 54 (A backup of the factory preset or user programs, either one by one or by bank may be made to an external MIDI storage device - See page 54)

NOTE: When the A-Station is shipped from the factory, the global memory protect switch is set to on. In order to save a sound, the global memory protect must be switched off.

Switching off Global Memory Protect

Press the MODE button repeatedly until the UTILITY LED is lit. Press the +(UNPROTECT) button once. The LED above and to the right of the FUNCTION switch will now light indicating that memory protect is now off (writing is enabled).

To save a program in the same location

Assuming the sound in location 499 has been edited, it may be saved in the same location or a different one. To save it in the same location, repeatedly press the MODE button until the SAVE mode LED is lit.

Press the + (WRITE) button once. The write and edit dots on the LED display will flash once to confirm that a new program has been written. If a program is written and there has been no edits (changes to the sound) then the write dot *only* on the LED display will flash. Once a sound has been written, the operating

MODE will automatically return to PROGRAM mode.

NOTE: Any edits to any parameters will cause the edit LED to light.

NOTE: Since there is only a two digit display available, a value of any parameter greater than 99 (100 - 127) will be displayed as (00. - 27.) Negative values greater than -9 will also be displayed as 10. - 63."

To save a program in a different location

Press the MODE select button until the SAVE LED is lit. Using the keypad buttons 0 - 9 only, select the program number where the new program is to be stored. Remember this is a three digit entry, (100 - 499)

Press the + (WRITE) once. The write dot (and the edit dot if there has been an edit) on the LED display will flash once to confirm that a new program has been written. Once a sound has been written, the MODE will automatically return to PROGRAM mode.

Using the Compare Function

After editing a sound it may be useful to compare it to the originally stored program.

Press the MODE button until the SAVE mode LED is lit. Hold down the - (COMPARE) button. The sound being listened to will be the originally stored program. Releasing the - (COMPARE) button will switch to listening to the edited sound again. To save the edited sound, press the + (WRITE) button.

Listening to the factory demonstration

To complete this Quick Start Guide section, some time spent listening to the sounds that the A-Station is capable of producing will be of benefit when it comes to creating new sounds.

Press the MODE select button repeatedly until the UTILITY LED is lit. Press the AUDITION (demo) button. The Factory demonstration will begin to play. To stop the demonstration, either press the AUDITION (demo) button again or press the MODE button to return to program mode.

Elements of a Sound

It is recommended that this chapter is read carefully if Analogue sound synthesis is an unfamiliar subject. Experienced users can skip this chapter and move to the chapter - **Main features and Operation** on Page 14.

Elements of a Sound

To gain an understanding of how a Synthesizer generates sound it is helpful to have an understanding of the components that make up a sound, be it musical or non musical.

The only way that a sound may be detected is by air vibrating the eardrum in a regular, periodic manner. The brain interprets these vibrations (very accurately) into one of an infinite number of different types of sound.

Remarkably, *any sound* may be described by just *three terms*, and all sounds *always* have them. They are :

- * Volume
- * Pitch
- * Tone

What makes one sound different to another is how these three terms *change* during the duration of the sound.

In a musical synthesizer we deliberately set out to have precise control over these three terms and, in particular, how they can be changed throughout the duration of the sound. These terms are often given different names, Volume is referred to as Amplitude, Pitch as Frequency and Tone as Timbre.

Pitch

Taking the example of air vibrating the ear drum, the pitch is determined by how fast the vibrations are. For an adult human the lowest vibration perceived as sound is about twenty times a second, which the brain interprets as a bass type sound, and the highest is many thousands of times a second, which the brain interprets as a treble type sound.

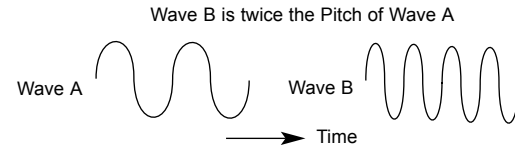

Tone

Musical sounds consist of several different related pitches occurring simultaneously. The loudest is referred to as the 'Fundamental' pitch. Pitches related to the fundamental are called harmonics. The relative loudness of these harmonics compared to the loudness of all the other harmonics (including the fundamental) determines the tone or 'Timbre' of the sound.

Volume

Volume, which is referred to as the amplitude or loudness of the sound is determined by how large the vibrations are. Very simply, listening to a piano from a metre away would sound louder than if it were fifty metres away.

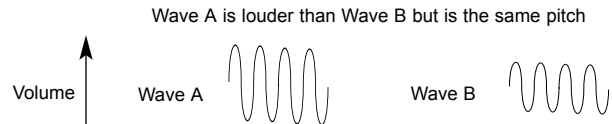

Having shown that just three elements make up a sound, these elements now have to be related to a Musical synthesizer. It is logical that a different section of the Synthesizer 'synthesizes' these different elements.

Oscillators and Waveforms

The Oscillator is really the heartbeat of the Synthesizer. It generates an electronic wave (which creates the vibrations) at a controllable musical pitch that has a distinctive tone or timbre.

Many years ago pioneers of musical synthesis discovered that just a few distinctive waves contained most of the useful harmonics for musical synthesis. They are known as, Sine waves, Square waves, Sawtooth waves, Triangle waves and Noise Waves.

Each one has a specific fixed amount of musically related harmonics (except noise waves) that can be manipulated by other sections of the Synthesizer. These waves are referred to as *Waveforms*.

A piece of equipment known as an *Oscilloscope* is able to display these waveforms on a television type screen. The name given to the waveform is simply because, when viewed on this piece of equipment, it looks like its named wave.

The diagrams show how these waveforms look on the Oscilloscope and illustrate the relative volumes of their harmonics.

In summary, the Oscillators generate *Waveforms* at a controllable pitch. These *Waveforms* determine the character (Timbre) of the sound.

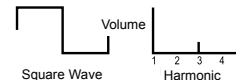
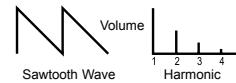
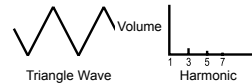
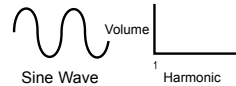

Sine waves have just a single frequency. This waveform produces the purest sound because it only has this single pitch (frequency).

Triangle waves contain odd harmonics only. The volume of each is the square of its position in the harmonic series. For example, the 5th harmonic has a volume of 1/25th of the fundamental.

Sawtooth waves contain all the harmonics of the fundamental frequency. The volume of each harmonic is proportional to its position in the harmonic series.

Square waves have only the odd harmonics present. These are at the same volume as the odd harmonics in a sawtooth wave.

Noise waves have no fundamental frequency and all frequencies are at the same volume.

Mixer and Filter

Mixer

To extend the range of sounds that may be reproduced, a typical Analogue synthesizer has more than one Oscillator. The A-Station has three independent Oscillators and a separate Noise Oscillator.

For flexibility, a mixer section is included so that the amplitude (volume level) of each of the Oscillators may be adjusted independently and mixed together to form a harmonically complex waveform.

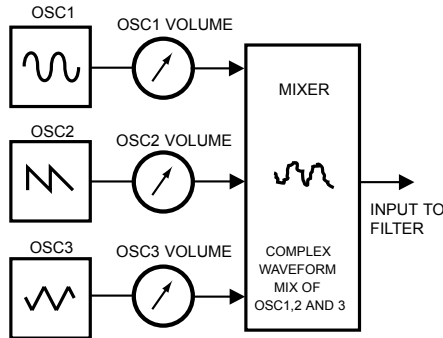

Filter

The A-Station is an *Analogue subtractive* type of music synthesizer. *Subtractive* implies that part of the sound is subtracted somewhere in the synthesis process.

The Oscillators provide the raw waveforms with plenty of harmonic content and it is the *Filter* that subtracts harmonics in a controllable manner.

The Filter in the A-Station is a Low Pass type. A cut-off point is

chosen and any frequencies below the point are passed and any above are filtered out. This process of removing harmonics from the waveforms has the effect of changing the sounds character or timbre.

In practice there is a gradual reduction in the volume of the harmonics above the cut-off point. How quickly these harmonics are reduced in volume above the cut-off frequency is determined by the Filter's slope. This slope is measured in 'volume units per octave' Since Volume is measured in decibels this slope is quoted in number of decibels per octave (dB). Typical values are 12dB or 24 dB per Octave. The higher the number, the faster the harmonics are cut and the more pronounced the filtering effect.

A further important feature of the Filter is the Resonance control. Frequencies at the cut-off point may be increased in volume by this control. This is useful for emphasizing certain harmonics of the sound.

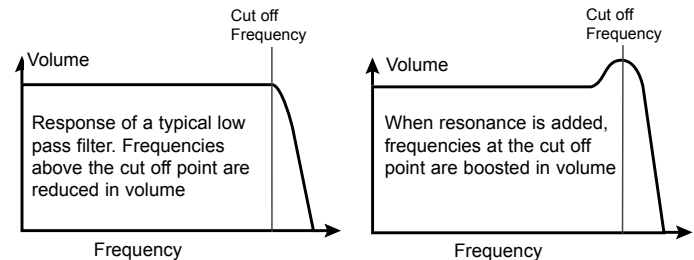

Envelopes and Amplifier

In earlier paragraphs, it was determined how the pitch and timbre of a sound is synthesized. This final part describes how the volume is controlled. The volume throughout the duration of a sound created by a musical instrument varies greatly according to the type of instrument.

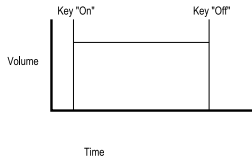

An Organ sound quickly attains full volume when a key is pressed. It stays at full volume until the key is released, at which point the volume falls to zero.

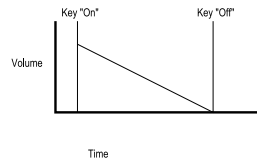

A Piano quickly attains full volume when a key is pressed and gradually falls back down to zero after several seconds, even if a key is held.

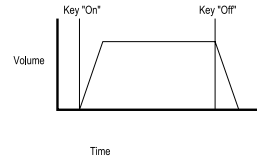

A String Section emulation attains full volume gradually when a key is pressed. It remains at full volume until the key is released, when gradually, the volume falls to zero.

The diagrams show how three instruments have very different volume characteristics. These volume intensity curves are referred to as volume *envelopes*.

In an Analogue synthesizer, an Envelope Generator circuit is connected to an *Amplifier*, which controls the Volume of the sound.

The envelope generators have four controls that are used to adjust the shape of the envelope.

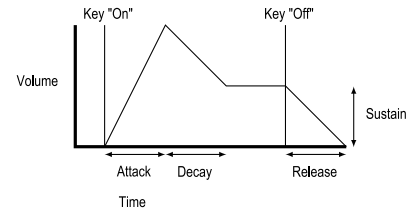

When controlling Volume, these controls adjust the following phases of the Envelope as shown in the illustration.

A = Attack time. Adjusts the time it takes when a key is pressed for the envelope to climb from zero to full volume. It can be used to create a sound with a slow fade in.

D = Decay time. Adjusts the time it takes for the envelope to decay from full volume to the level set by the Sustain control.

S = Sustain level. Sets the level that the envelope remains at while the key is held down.

R = Release time. Adjusts the time it takes when key is released from the Sustain level to zero. It can be used to create sounds that slowly fade away in volume.

A typical synthesizer will have one or more envelopes. One is always applied to the amplifier. Additional envelopes are typically used to modify the filter cut off frequency or change an oscillators pitch.

LFOs

The electronic building blocks so far described allow a sound to be synthesized. However, apart from the volume changing throughout the duration, the sound would be fairly static and uninteresting.

Most musical instruments produce sounds that vary not just in volume but also in pitch and timbre. To generate this movement, additional sound modifying blocks are included in a typical Analogue Synthesizer. These generate low frequency waveforms of distinct shapes. They are given the name **LFOs** (Low Frequency Oscillators).

The waveforms generated by the LFO's may be fed to other parts of the synthesizer to create the desired movements.

A typical waveshape for an LFO would be a Triangle wave. Imagine this slow moving wave being applied to an Oscillator's pitch. The result would be that the pitch slowly rises and falls above and below its original pitch.

This would simulate, for example, a violinist moving a finger up and down the string of the instrument whilst it is being bowed.

This subtle up and down movement of pitch is referred to as the 'Vibrato' effect.

As well as LFOs being available to modify (or more commonly known as **Modulate**) different sections of the synthesizer, additional Envelopes may also be used.

Clearly the more Oscillators, Filters, Envelopes and LFO's there are in a Synthesizer, the more powerful it becomes.

Memories

Many years ago large modular machines were produced where each part of the synthesizer was housed in a separate unit (block). These blocks could be connected together in any combination by patch leads. Every time a new sound was required the leads would have to be physically disconnected and reconnected.

Modern machines such as the A-Station have all the blocks in one compact unit and the sound generating or modifying blocks are arranged in a sensible fashion. Front panel switches and knobs determine how each block functions and where the sound modifying blocks such as the LFOs and Envelopes are routed.

The settings of these front panel controls (which of course determine the current sound) may then be stored in memory locations in the machine which can be recalled at any time.

knobs and switches are made will make to process of creating new and exciting sounds easy - Have fun.

Summary

An Analogue synthesizer can be broken down into five main sound generating or sound modifying (modulating) blocks.

- 1 Oscillators that generate Waveforms at a certain pitches.
- 2 A Mixer that mixes the outputs from the Oscillators together.
- 3 A Filter that cuts out certain harmonics, which changes the characteristic or timbre of the sound.
- 4 An Amplifier that is controlled by an Envelope generator, that alters the volume of a sound over time.
- 5 LFO's and Envelopes that can be used to modulate any of the above.

Much of the enjoyment to be had with a Synthesiser is with experimenting with the factory preset sounds and creating new ones. There is no substitute for 'hands on' experience.

Armed with the knowledge in this chapter, and understanding what is actually happening in the machine when tweaks to the

Volume and Portamento controls - Function Switch and LED

This chapter describes the main front panel controls and how they affect a sound.

Volume knob

This knob is dual function. When the FUNCTION switch is set to NORMAL it adjusts the *overall output volume* on both the Left and Right master audio outputs on the rear panel and the Headphone output on the front panel. Using a mixing desk as a comparison, this control can be thought of as the channel volume fader.

When the FUNCTION switch is set to SHIFT the volume knob adjusts the *program output level*. This control is used to maintain a consistent volume level without distortion throughout all sound programs. Delicate sounds, those which use just one Oscillator and closed filter settings, can be increased in volume using this control. Conversely, sounds that use all Oscillators and high polyphony (6 to 8 notes played at once), can be reduced in volume to avoid distortion. Using a mixing desk as a comparison, this control can be thought of as the *gain* or *trim* control for the channel.

Portamento / Value knob

This knob is dual function. When the FUNCTION switch is set to NORMAL (left position) it adjusts the Portamento effect. Notes change instantly from one pitch to another when this knob is zero. Turning the knob clockwise introduces the Portamento effect. Notes will glide smoothly from one pitch to the next. Increasing the amount will slow the time taken for the pitch of the first note to reach that of the second note played. When the FUNCTION switch is set to SHIFT (right position) this



knob adjusts the value of the data on the display. For example if Reverb is selected, this knob will control the amount of Reverb applied to the sound.

Function switch and LED

This switch and its associated LED behave differently depending on the MODE selected.

Function switch operation in PROGRAM MODE

Set to NORMAL, programs may be selected by using the 0-9 and + / - keys on the data entry keypad. Set to SHIFT, the 0-9 keys select the function labeled in the light blue highlighted area below each rubber key such as Delay, Reverb. The + / - keys may still be used to select the PROGRAM number. The LED above the switch will light to indicate SHIFT selected. In SHIFT position, certain other front panel knobs and switches have a secondary (shifted) function. - See following pages.

LED operation SAVE and UTILITY mode

In SAVE and UTILITY mode, the LED above the FUNCTION switch will light if writing to program memory is enabled. (Global memory protect set to 'off').

Headphone Jack

This stereo output jack socket will drive most Stereo headphones and monitors the main Left and Right audio outputs.

Mode Select button

Selects which MODE the 0-9 keys and + / - keys are operating in. The mode is indicated by one of five LEDs on the right hand side of the LED display panel.

When the A-Station is switched on, PROGRAM mode is automatically selected.

Each time the button is pressed, the next operating mode will be selected - SAVE, UTILITY, MIDI TX Channel and MIDI RX Channel and a final loop back to PROGRAM mode. The MODE sequence will run from the bottom to the top of the column of LEDs.

Mode Button	Operating Mode
Power up default	Program
1st Press	Save
2nd	Utility
3rd	MIDI Transmit Channel
4th	MIDI Receive Channel
5th	

PROGRAM MODE

Sounds (programs) may be selected using the 0-9 and + / - key on the keypad. The PROGRAM LED indicates what program-

bank is selected.

SAVE MODE

Sounds (programs) may be compared (using - key), or written to (using + key) a memory location in this mode. The 0 - 9 keypad buttons are used to select the destination memory location for the sound to be saved. - Also see Page 6.

UTILITY MODE

The Global Menu (which has options that affect the overall operation of the machine and the sending of Program memories to external devices (backing up)) may be accessed in this mode. Pressing keypad button 0 activates the Global Menu. See Page 50 for Global settings and Page 54 for saving sounds to external devices.

MIDI Tx CH mode allows the MIDI transmit channel to be set. Use the PORTA/DATA knob to enter the channel number. The recognised MIDI channel numbers are 01 to 16.

NOTE: The MIDI TX and RX channel settings are automatically memorised when exiting from this mode.

MIDI Rx CH mode allows the MIDI receive channel. Use the PORTA/DATA knob to enter the channel number.

The MIDI RX CH LED will flash when MIDI data is received on the selected channel.

Oscillators

Oscillators

The Oscillators generate pitched waveforms (as described in the Synthesis tutorial) and these are fed into the Mixer. Most of the controls that determine the pitch and waveform of the Oscillators, and how they react to modulation are in this area.

Osc Select Switch

There are three independent Oscillators and each one can be independently controlled by the switches and knobs in the Oscillator area. To adjust the controls for Oscillator 1, select position 1, to adjust Oscillator 2, select position 2 and to adjust Oscillator 3, select position 3.

Octave Switch

Sets the basic pitch of Oscillator 1, 2 or 3 in Octave jumps. To change the basic pitch of Oscillator 1, set the OSC SELECT switch to position 1 and move the OCTAVE switch to position 1

NOTE: The **0** position corresponds to the pitch of 440Hz when note A above middle C is played.

Waveform Switch

In the \nearrow [~] position, the selected Oscillator's waveform will change to Sawtooth if the FUNCTION switch is set to NORMAL or Sine if the FUNCTION switch is set to SHIFT.

In the \sqcap [^] position, the selected Oscillators waveform will change to Square if the FUNCTION switch is set to NORMAL or Triangle if the FUNCTION switch is set to SHIFT.

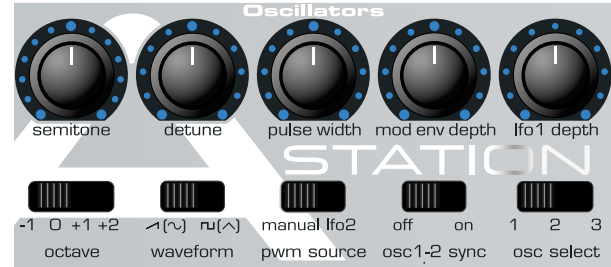

Oscillator 1 - 2 Sync Switch

Synchronizes the waveform of Oscillator 2 to Oscillator 1. Each time Oscillator 1 completes its cycle it resets the start cycle of Oscillator 2. When listening to Oscillator 2 only, it has a dramatic effect on the timbre of the sound. The easiest way to illustrate the effect is to create a sound using the Oscillator Sync.

Creating a sound using the Sync Effect

Select a factory preset basic sound - preset 499. Select OSC 1 and set its WAVEFORM to square - \sqcap [^]. Turn the OSC 1 & 2 knob in the MIXER section to fully clockwise to OSC 2. Select OSC 2 in the Oscillator Section. Select OSC 2 WAVEFORM to square - \sqcap [^]. Play a note and listen to the sound. It will be a simple tone.

Apply a little MODE ENV depth by turning the MOD ENV DEPTH knob slightly clockwise from centre. Adjust the MOD ENV ATTACK and MOD ENV DECAY in the Envelopes section. Listen to the sound, it will now rise and fall quickly at the begin

ning of the sound and rest at a final pitch. Finally turn the OSC 1-2 sync on by sliding the switch to the ON position.

Experiment with the sound by raising the semitone pitch of OSC 2 and by adjusting the MOD ENV ATTACK and DECAY knobs in the Envelopes section.

PWM (Pulse Width Modulation) Source switch and Pulse Width knob

The function of the PULSE WIDTH knob is dependent on the PWM SOURCE switch.

With the switch in the MANUAL position, the PULSE WIDTH knob will manually control the pulse width of a square waveform (The selected waveform for the Oscillator must be Square for this to happen). In order to understand how the Pulse Width knob affects other waveforms see the paragraph following titled:

Width control of other Waveforms.

With the PULSE WIDTH knob in the central position, the Pulse Width wave becomes a square wave. As the knob is adjusted clockwise, or anticlockwise, the Pulse Width becomes narrower, producing thinner more nasal sounds.

With the PWM SOURCE switch in the LFO 2 position, the width of the Pulse Wave may be modulated by either LFO 2, or, when the FUNCTION switch is set to SHIFT, the MOD ENV. The intensity of this modulation is determined by the PULSE WIDTH knob. With the Pulse Width knob at central position there is no effect. Turning clockwise or anticlockwise introduces the effect. Continuous variation in the width of a pulse waveform (which is

what is happening when LFO 2 is modulating it) changes the harmonic content. This is pleasing to the ear, especially at lower pitches where all the associated harmonics fall within the audio range.

When modulated by the MODE ENV, the effect is most apparent when using fairly long Mod Env Attack and Decay times.

Width control of other waveforms

If the square wave is not selected for the Oscillator being adjusted by the pulse width control, its waveform will gradually change to a double waveform of the same type as the pulse width control is moved away from its central position.

Very thick sound textures may be created by using LFO2 to modulate this doubling effect. To hear the effect, select a sawtooth waveform for one of the Oscillators. Set the PWM SOURCE switch to the LFO2 position. Set LFO2's waveform to triangle. Introduce an amount of modulation from LFO2 by moving the PULSE WIDTH knob from its central position. Adjust the speed of LFO2 and notice how the speed affects the apparent detuning 'thickening' of the sound.

Oscillators

Detune Knob

Sets the detune amount in Cents for the selected Oscillator 1, 2 or 3. If it is set fully clockwise, Oscillators pitch will be 50 cents sharper than its basic pitch, fully anticlockwise and it will be 50 cents flat.

Slight detuning between each Oscillator will enrich the sound by introducing a beating between the Oscillators (in the same way a 12-string guitar sounds richer than a 6-string). Bass and lead sounds can be fattened up using a small amount of detune. Large amounts of detuning will lead to more extreme effects.

Semitone

Raises or lowers the selected Oscillators pitch in semitone increments up to a full octave. By setting the pitch of Oscillator 1 to zero and adjusting the pitch of Oscillator 2 and 3 by differing amounts results in some musically pleasing intervals. Settings 5 (a perfect 4th), 7 (a perfect 5th), 3 (minor 3rd), 4 (major 3rd), 8 (minor 6th) and 9 (major 6th) offer the best results.

Mod Env Depth Knob

Controls the amount of pitch modulation to the currently selected Oscillator from the Mod Envelope. In the centre position there is no effect on the oscillator's pitch, anticlockwise the effect is negative (i.e. the pitch drops and then rises) and clockwise positive (the pitch rises and then falls).

See Page 22 - Amp and Mod Envelopes, for the setting of the rise and fall times.

LFO1 Depth Knob

Controls the amount of pitch modulation to an Oscillator from LFO 1. It controls how much above and below the basic pitch the Oscillator regularly rises and falls. If the LFO is set to Triangle wave and the LFO's speed knob is above the centre of its range, this will produce a vibrato effect. Other effects like a siren or sea gull cry are possible with more extreme settings.

Mixer

The Mixer makes it possible to combine the outputs of Oscillators 1, 2 and 3, the Noise source, the Ring modulator and the external Audio Input. The ability to mix together any or all of these sound sources makes it easy to create complex timbres.

Osc 1 & 2 Knob

Controls the volumes of the two Oscillators. Fully anticlockwise results in no signal. In this position and with all the other Mixer levels turned down, there will be no audio output. Turning clockwise, Oscillator 1 will be introduced. At the 1 & 2 position both Oscillators will be of equal volume. Fully clockwise results in Oscillator 2 only being heard.

Osc 3 Knob

Controls the volume of Oscillator 3. Fully anticlockwise results in no signal. Fully clockwise results in full volume for this Oscillator.

Source Switch and level Knob

Selects which sound source the level knob will control.

In the NOISE position it controls volume of the White Noise Generator. White Noise is useful for creating sound effects such as Wind.

In the RING position it controls the volume of the Ring Modulator. Ring Modulation is useful for creating harder Metallic tones.

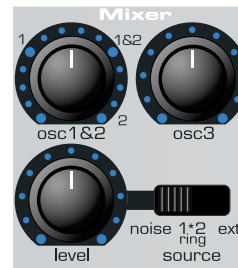

In the EXT position it controls the volume of the External audio input signal. This signal can be processed by the filter, envelopes and effects.

Note: All three sound sources may be used simultaneously and if they are, it may be necessary to reduce the program level (see page 14).

Filter

Filter

The Filter is a Low Pass type. As the frequency knob is adjusted anticlockwise, harmonics are gradually removed from the sound. When almost closed, only the fundamental frequency remains. Fully closed and no sound at all passes. This type of Filter is musically the most useful, especially for bass sounds.

Cut off Switch

Controls how drastically the frequencies above the Cut off point are removed from the sound. In the 12dB position, the Cut off slope is gentle so higher harmonics are not attenuated (reduced in volume) as sharply as they are when in the 24dB position.

Frequency (Overdrive) Knob

This knob is dual function, When the FUNCTION select switch is set to NORMAL it controls the basic Cut off frequency of the filter. If set fully clockwise and the filter is wide open allowing all frequencies (harmonics) produced by the Oscillators to sound. As the knob is turned anticlockwise, the filter closes, cutting out harmonics, starting with the highest, then increasingly lower ones until only the fundamental or nothing at all is allowed to sound (fully anticlockwise).

If there is silence when the VOLUME knob is turned up, it is most likely that the Filter is fully closed. Turn the Frequency knob clockwise to open the filter.

When the FUNCTION select switch is set to SHIFT, this knob controls the Filter OVERDRIVE. Used in large amounts it will have the effect of making the sound richer and slightly distorted.



Resonance (Resonance Normalize) Knob

This knob is dual function, When the FUNCTION select switch is set to NORMAL this knob will control the Resonance of the Filter. The control will boost frequencies at the Cut off frequency. On some synthesizers this control is known as Emphasis since it will emphasize certain frequencies. At the zero position there is no effect. Turning clockwise slowly introduces the emphasis.

If set fully clockwise, the Filter will begin to self oscillate, producing a new pitched element (similar to feedback on an electric guitar).

When the FUNCTION select switch is set to SHIFT, this knob controls the Resonance Normalize. At zero, when resonance is applied, the main audio signal will remain at normal levels. Adjusting clockwise will reduce the signal level in relation to the resonance level. This control enables the Filter to emulate

many of the classic Filters such as the Moog type, Oberheim type and Roland TB303* type.

If the A-Station produces a high pitched whistling sound, it is probably due to this knob is being adjusted too far clockwise. If this self-oscillating effect is not desired, keep the Resonance control away from the extreme clockwise setting. Increasing the Resonance is very good for bringing out modulation (movement or change) in the filter Cut off frequency, such as in Acid bass lines and other very edgy sounds.

K'YBD Track Knob

Controls the amount of change to the filter Cut off (set by the Frequency knob) by the pitch of the note played. Set fully anti-clockwise and there is no change to the filter Cut off frequency. With clockwise movement there will be an increasing amount of modulation. The filter will be opened more as higher notes are played on the keyboard. This control is used to define how the timbre of a sound changes over the keyboard. At the 10 position the filter tracks the pitch changes in a 1 to 1 ratio.

Mod Env Knob

Controls the amount of change to the filter Cut off (set by the Frequency knob) by the Modulation Envelope. In its central position there is no change to the filter Cut off frequency. Adjusting the knob anticlockwise from centre will introduce an increasing amount of negative modulation. The filter will close as the MOD ENV runs through its cycle. Adjusting the knob clockwise from centre will introduce an increasing amount of positive modulation. The filter will be opened by the MOD ENV.

LFO 2 Depth Knob

Controls the amount of change to the filter Cut off (set by the Frequency knob) by LFO 2. In its central position there is no change to the filter Cut off frequency. Adjusting the knob anti-clockwise from centre will introduce an increasing amount of negative modulation. The filter will close and open in time with LFO2 (this creates the popular wow wow effect).

Adjusting the knob clockwise from centre will introduce an increasing amount of positive modulation. The filter will open and close in time with LFO 2.

NOTE : An external audio signal such as a microphone, guitar or CD player may be processed by the filter and effects. Refer to pages 50, 54 and 55 in the Advanced Features Chapter for more details on setting up this feature.

*TB303 is a trademark of the Roland corporation of Japan

Amp and Mod Envelopes

Amp and Mod Envelopes

The Envelopes are used to shape the sound throughout its duration. The AMP Envelope determines the volume of the sound with respect to its duration.

The MOD Envelope may be used to control other sound elements of the synthesizer throughout the duration of the sound. It can control Pulse Width, Filter frequency and Oscillator Pitch.

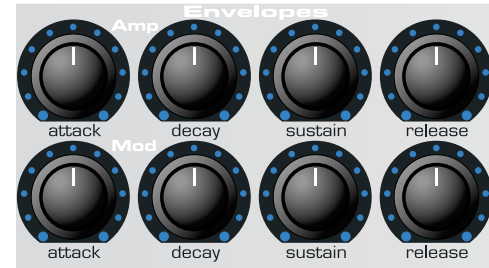

Attack Knob

Sets how quickly the envelope rises to its maximum level when a note is struck. Fully anticlockwise and this rise time or slope is very fast, less than half a thousandth of a second (instantaneous to the ear) increasing exponentially to twenty seconds when fully clockwise. To shorten attack times turn this knob anticlockwise and to lengthen attack times turn this knob clockwise.

NOTE: When the attack time is set to Zero the instantaneous rise time of the Envelope may produce audible 'clicks'. This is not a faulty condition and may be useful for the creation of certain sounds. If this is undesirable, increase the Attack time until the clicks are inaudible.

Decay Knob

Sets how quickly the envelope falls to a sustain level after the maximum level has been reached. Fully anticlockwise and this time is about one thousandth of a second (still instantaneous to the ear) increasing exponentially to twenty seconds when fully

clockwise. To shorten decay times turn this knob anticlockwise and to lengthen decay times turn this knob clockwise.

Sustain Knob

Sets the level at which the envelope remains following the Decay phase, only while a key is being held on a controller keyboard (or there is a Midi note on command present). Fully anticlockwise and the envelope will decay to zero without being interrupted. As the knob is turned clockwise, the sustain level increases until, when fully clockwise, the sustain level is at maximum.

Release Knob

Sets how quickly the envelope falls from the sustain level to zero once the note has been released. Fully anticlockwise this time is about one thousandth of a second (instantaneous to the ear) increasing exponentially to twenty seconds when fully clockwise. To shorten release times turn this knob anticlockwise and to lengthen release times turn this knob clockwise.

LFOs

There are two LFOs - Low Frequency Oscillators - available. These produce regular electronic variations which are too low to be heard when converted into audio vibrations. They can be used to modify various elements of the sound, producing regular changes in pitch (vibrato), pulse width or filter Cut off.

LFO Select Switch

Selects which LFO the Speed, Delay and waveform controls relate to. Select position 1 for LFO 1 and 2 for LFO 2.

Speed Knob

Controls the speed of the low frequency Oscillations. An LED directly below the knob indicates the speed. Faster speeds are set by turning the knob clockwise. These are suitable for vibrato and tremolo effects. Slower speeds are more appropriate for Pulse Width changes or special effects.

Delay Knob

Controls how long after the note is struck the selected LFO begins to take effect. Fully anticlockwise and the selected LFO effect will begin immediately. Turning clockwise it will introduce a time delay before the LFO effect can be heard. This is particularly useful for delayed vibrato effects.

Shape - Switch

Selects the waveform shape for the selected LFO.

S/H - Sample & Hold. At a regular interval (governed by the Speed knob), the level of the LFO jumps to a new random level



and stays there until the next jump. This creates a rhythmic effect particularly if routed to the Filter Cut off. Routing this to pitch gives a less musical result, but is useful for computer or machinery sound effects.

TRI - Triangle waveform gives the smoothest continuous change in level to the LFO. When routed to pitch, it introduces vibrato or a siren effect dependent of its speed setting. When routed to Filter Cut off, a Wow Wow effect results.

SAW - Sawtooth waveform generates a falling level which then jumps back up to full level. Routed to the Filter Cut off, it produces a rhythmic pulse effect. Routing it to pitch produces siren type sounds.

SQR - Square waveform changes level instantly from minimum to maximum. This waveform is useful for trills and computer game effects.

Effects - Delay

This chapter describes how to use the advanced features of the Effects, Arpeggiator, Synchronization, Triggering and the Utilities.

Effects

The A-Station features a powerful effects processor. Used in a creative fashion, it can greatly enhance a sound.

Delay Effect

The comprehensive Delay effects processor has many programmable parameters. These may be edited to create the desired delay effect for a particular sound and saved with the sound.

Delay Level

Sets how much of the delayed or echoed sound can be heard.

Delay Time

Controls the amount of time it takes for the delayed signal to be heard after the original signal.

Delay Feedback Amount

Controls how much of the delayed signal is fed back into the delay input. No feedback produces a slapback echo effect, just one delayed sound with no repeats. Small amounts of feedback produce repeated sounds resulting in a multiple echo effect. Large amounts of feedback produces infinite echoes.

Delay Sync

The time of the Delay repeats can be synchronized to the tempo of a song. The standard synchronization method is to use a MIDI clock as a master timer (See page 26). This may be used to lock the repeats in time with a range of musical timings (See table on page 27).

Delay Stereo Width

Sets the Stereo spread between the long and short Delay times. With a width setting of zero, both delays appear in the middle of the stereo field (Mono). At maximum width setting, the longer delay will appear on one output and the shorter on the other, producing a dramatic stereo effect.

Delay Ratio

Automatically adjusts the ratio of the longest delay time and the shorter delay time into timings that are musically useful. (See Delay ratio table on page 26 for timing).

Wheel Level

Sets how much the movement of the Modulation wheel on a Midi controller keyboard will introduce the delay effect.

To access the Effects processor and other menus, the FUNCTION switch in the master control area must be set to SHIFT (right hand position).

Instead of numerically selecting programs, the keypad accesses Menus as described by the legends below each key. For example KEY 1 accesses the *DELAY effects Menu*, KEY 5 accesses the *VOCODER effects Menu* etc.



Operation of Menus

In SHIFT mode, each key therefore has a menu associated with it and for ease, the contents of the menus are presented in this manual in the form of a table. The first press of the specific button enters the first level of the menu. Subsequent key presses select a new item in the menu until the final one is reached. A further press loops back to the first item (See the Delay table menu opposite as an example).

A previous item in the Menu may be selected by pressing the AUDITION button. This allows for easy navigation, both backwards and forwards in the menus. NOTE: The Audition button only behaves like this when the FUNCTION button is in the SHIFT mode.

Adding a Delay effect to a sound

Ensure the function switch is set to SHIFT. Press KEY 1 and the display shows **d L** with an alternating value. Turn the PORTA/DATA knob clockwise.

Depending on the settings of the other parameters in the

Delay Menu			
Key 1	Function	Alternating	LED Display
▶ 1st Press	Delay Level	d L	0 - 27.
2nd	Delay Time	d t	0 - 27.
3rd	Delay Feedback	d F	64. - 63
4th	Delay Sync	d y	oF - 2b
5th	Delay Stereo Width	d S	0 - 27.
6th	Delay Ratio	d r	11 - 14
7th	Delay Wheel Level	d u	0 - 27.
8th			

delay menu, a delay effect will be heard.

Note: As long as the function switch is set to shift, the display will alternate as in the menu table. To return to displaying and selecting a program, set the switch back to normal mode.

Effects - Delay

Delay Synchronisation

A very pleasing audio effect may be heard when the Delay time is synchronized to the tempo of musical piece. The table on the following page describes the musical timings available.

Setting up a synchronized delay effect using midi clock sync sent from an external sequencer.

Press the MODE SELECT button until the UTILITY LED is lit. Repeatedly press KEY 0 until the display shows **C S** (Clock Sync) and an alternating value. Set to **e** (external) by turning the PORTA/DATA knob. The tempo that the synchronization will lock to will now be dictated by the MIDI clock being sent by an external sequencer.

NOTE: When set to **i** (internal) the Arpeggiator Rate (set in the Arpeggiator Menu) will be the master tempo control.

Check that the sequencer is sending MIDI clock events, and play a previously recorded sequence.

Return to PROGRAM MODE (Press the MODE SELECT until the PROGRAM LED is lit).

Ensure the function switch is set to SHIFT. Turn the PORTA /DATA knob clockwise so that the delay effect may be heard. Repeatedly press KEY 1 until the display shows **d y** - delay sync value. Turn the PORTA/DATA knob to experiment with different lengths of delay. The repeats will now be in time with the musical piece, the repeat time being determined by the synchronization value.

Changing the Delay ratio

There are thirteen musically useful Delay ratios available. Ensure the function switch is set to SHIFT. Repeatedly press KEY 1 until the display shows **d r** - delay ratio value.

Use the PORTA/DATA knob to select the most suitable ratio. A Simple equal 1 to 1 ratio is the first entry in the table. This setting sends a delay of equal time to the left and right output channels. The number in the left column of the table indicates the ratio of the delay time that will be in the left channel versus the number in the right column.

Delay Ratio Table

Left	Right
1	1
4	3
3	4
3	2
2	3
2	1
1	2
3	1
1	3
4	1
1	4
1	0
0	1

For example, if a delay of twice the time is required in the left channel compared to the right, select the 2 1 option. The final 1 0 and 0 1 options will result in no delay being in the channel indicated by the 0.

Delay, Panning, Chorus, Arpeggiator and LFO's Synchronisation to MIDI Clock Table

Display	MIDI Clocks	Synchronised to:-	Display	MIDI Clocks	Synchronised to:-
o F	-	Free running	1 d	144	1.5 Bars
3 t	2	32nd Triplet	2 b	192	2 Bars
3 2	3	32nd	4 t	256	4 Bar Triplet
6 t	4	16th Triplet	3 b	288	3 Bars
1 6	6	16th	5 t	320	5 Bar Triplet
8 t	8	8th Triplet	4 b	384	4 Bars
6 d	9	16th Dotted	3 d	432	4.5 Bars
8	12	8th	7 t	448	7 Bar Triplet
4 t	16	4th Triplet	5 b	480	5 Bars
8 d	18	8th Dotted	8 t	512	8 Bar Triplet
4	24	4th	6 b	576	6 Bars
2 t	32	2nd Triplet	7 b	672	7 Bars
4 d	36	4th Dotted	5 d	720	7.5 Bars
2	48	2nd	8 b	768	8 Bars
1 t	64	1 Bar Triplet	9 b	864	9 Bars
2 d	72	2nd Dotted	7 d	1008	10.5 Bars
1 b	96	1 Bar	1 2	1152	12 Bars
2 t	128	2 Bar Triplet			

Five different effects use this table to determine the musical time synchronized to. For example, to Pan the sound to the left for 1 Bar and then to the right for 1 Bar select option **1 b** - 1 Bar. To have a Delay repeat every crotchet (quarter note) select **4**.

Effects - Reverb

Reverb

The Reverb Effect is an electronic simulation of a room or building that is acoustically reflective.

When a sound is made in a room or large building, there are sound reflections from all directions. When a Reverb effect is added, it is these reflections of the sound that are being added.

Adding a Reverb effect to a sound

Ensure the function switch is set to SHIFT. Press KEY 2 and the display will show **r L**. Turn the PORTA/DATA knob clockwise. A Reverb effect will be heard. The Reverb menu table opposite lists the parameters that may be edited for the Reverb processor.

Reverb type

Different types of rooms and halls have different acoustics, therefore different Reverb characteristics. The Reverb processor features six different Reverb types. These range from a small room to a large hall.

Changing the Type of Reverb

Ensure the function switch is set to SHIFT. Repeatedly press KEY 2 until the display shows **r t**. Turn the PORTA/DATA knob to experiment with different types of Reverb (See table opposite for display legends).

Reverb Decay Time

This is the time it takes for the Reverb to die away after the

original sound has decayed. Very acoustically reflective rooms (like those with metal or glass surfaces) tend to have long decay times and non reflective rooms have short ones.

Reverb Menu			
Key 2	Function	Alternating LED Display	
▶ 1st Press	Reverb Level	r L	0 - 27.
2nd	Reverb Type	r t	S r - L h
3rd	Reverb Decay	r d	0 - 27.
4th	Reverb - Wheel Level	r u	0 - 27.
5th			

Reverb Type	Description
E c	Echo Chamber
S r	Small Room
S h	Small Hall
L r	Large Room
L h	Large Hall
G h	Grand Hall

Reverb Wheel Level

Sets how much movement of the Modulation wheel on a MIDI controller keyboard will introduce the Reverb effect.

Chorus

This effect was originally designed to simulate the sound of many people singing together (hence the name Chorus) in contrast to a single voice. Instrumentally, consider the sound of a 12 string guitar compared to a 6 string guitar.

Chorus is an effect produced by mixing a continuously delayed version of the audio signal back with the original. The timing of the delayed version is very small and is controlled by the chorus's own internal LFO. The characteristic swirling Chorus effect is the result.

Adding a Chorus effect to a sound

Ensure the function switch is set to SHIFT. Press KEY 3 and the display will show **c L** with an alternating value. Turn the

Chorus Menu			
Key 3	Function	Alternating LED Display	
1st Press	Chorus Level	c L	0 - 27.
2nd	Chorus Type	c t	C h - P h
3rd	Chorus Rate	c r	0 - 27.
4th	Chorus Sync	c y	oF - 12
5th	Chorus Mod Depth	c d	0 - 27.
6th	Chorus Centre	c c	64. - 63
7th	Chorus Feedback	c F	64. - 63
8th	Chorus LFO Initial Pos'n	c l	o F - R t
9th	Chorus Wheel Level	c u	0 - 27.
10th			

PORTA/DATA knob clockwise. A Chorus effect will be heard. The Chorus menu table below lists the parameters that may be edited in for the Chorus processor.

Types of Chorus

Chorus

Chorus provides a stereo effect with a smooth swirling sensation that fattens up sounds and provides a stereo image. Chorus retains the definition of the effected sound making it more suitable for basses, organs and percussive sounds.

Phaser

Although referred to as a Chorus type, the Phaser effect is in fact entirely different. A portion of the audio signal is split off and phase shifted at certain frequencies. It is then mixed back with the original signal to generate the characteristic swishing effect.

Changing the Type of Chorus

Ensure the function switch is set to SHIFT. Repeatedly press KEY 3 until the display shows **c t** alternating with either **C h** - Chorus or **P h** - Phaser. Turn the PORTA/DATA knob to switch between Chorus and Phaser.

Chorus Speed

Controls how fast the internal LFO is oscillating. A fairly slow speed is recommended. Higher speeds tend to introduce a vibrato like quality to the sound.

Effects - Chorus - Phaser - Distortion

Chorus Sync

Similar to Delay Sync, the Chorus's own internal LFO may be synchronized to internal or external MIDI clock tempo - Refer to Page 26 - Setting up synchronization with MIDI clock.

Chorus Mod Depth

The Chorus has its own LFO which is continuously changing the delay time. The MOD DEPTH sets how much of the fixed delay time is being modulated. Large amounts of modulation will produce a more noticeable effect. Moderate amounts are recommended.

Chorus Centre

The Stereo Chorus can be thought of as two continuously variable delays. The delay variations are being controlled by the LFO. The LFO is constantly moving the two delay amounts from minimum to maximum. When one delay is at max the other is at min (hence the stereo effect) The CHORUS CENTRE control moves the middle point between the Min and Max values. Experiment with this control for the desired effect.

Chorus Feedback

Feedback controls how much of the delayed signal is fed back to the input of the Chorus generator. The Chorus effect benefits from low levels of feedback. The Phaser effect requires higher levels of feedback.

Chorus LFO Initial Position

As well as being able to synchronize to MIDI clock (tempo), the Chorus LFO may have its initial position set after a specific MIDI event is received (see page 51 - Global menu options).

Chorus LFO Initial Position	Description
o F	Off
L t	Left
C t	Centre
R t	Right

The initial positions are shown in the table above. For example, if the Chorus initial position sync is set to **R t**, after a MIDI event the Chorus effect will move from the right to the left.

Chorus Wheel Level

Sets how much movement of the Modulation wheel on a MIDI controller keyboard will introduce the Chorus effect.

Distortion

Distortion is an effect commonly used by Guitar players, however it is increasingly used in the production of modern Dance music. The effect gives the sound a hard edged, distorted and dirty kind of quality.

Adding a Distortion effect to a sound

Ensure the function switch is set to SHIFT Repeatedly press KEY 4 until the display shows **d d** (Distortion Drive) and an alternating value. Turn the PORTA/DATA knob clockwise. The sound will distort in relation to the setting of the PORTA/DATA knob.

The Distortion and Panning menu table opposite lists the parameters that may be edited in for the Distortion and Panning processor.

Distortion Compensation

If distortion is added to a sound it will tend to get louder. In order to contain or compress the sound back to a level which is consistent with other programs, use the compensation control.

Distortion Wheel Amount

Determines how much movement of the Modulation wheel on a MIDI controller keyboard will introduce the Distortion effect.

Panning

The Panning control in the A-Station performs the same function as the Panning knob on a mixing console. It can be used to position a sound anywhere from left to right in the stereo field.

Changing the Pan Position of a sound

Ensure the function switch is set to SHIFT. Repeatedly press KEY 4 until the display shows **P P** and an alternating value. Turn the PORTA/DATA knob clockwise or anticlockwise to move the sound across the Stereo field.

Pan Depth

A subsequent press of Key 4 will select Pan Depth. This parameter determines how much of the Panning effect can be heard.

Distortion.. Panning.. Menu			
Key 4	Function	Alternating LED Display	
▶ 1st Press	Distortion Drive	d d	0 - 27.
2nd	Distortion Compensation	d c	0 - 27.
3rd	Distortion Wheel Amt	d u	0 - 27.
4th	Pan Position	P P	64. - 63
5th	Pan Depth	P d	0 - 27.
6th	Pan Rate	P r	0 - 27.
7th	Pan Sync	P Y	oF - 12
8th	Panning's LFO Initial Position	P I	oF - R t
9th	EQ Amount	E A	64. - 63
10th	EQ Frequency	E F	0 - 27.
13th	EQ Depth	E d	0 - 27.
11th	EQ Rate	E r	0 - 27.
12th	EQ Sync	E y	oF - 12
14th	EQ LFO Initial Position	E k	oF - R t
15th			

Pan Rate

If the Pan Depth is set to a non zero value, the sound will move from the Left to the Right at at speed determined by the Pan Rate.

Effects - Panning - EQ Filter

Pan Sync

A very pleasing audio effect may be heard when the Panning effect is synchronized to the tempo of a musical piece. The table on the Page 27 describes the musical timings available.

Set to **o F** and the Panning effect will be at the rate determined by the Speed parameter. Set to any other selection, the Panning will be in time with the selected musical timing. This works in similar way to Delay sync (refer to Page 26 for information on setting up this feature).

Panning LFO Initial Position

As well as being able to be synchronized to a MIDI clock (tempo), the Panning LFO may have it's initial position set after a specific MIDI event is received (see page 53- Global menu options).

The initial positions are shown in the table below. For example, if the Panning initial position sync is set to **R t** (Right), after a MIDI event the sound will begin in the right output audio channel and then move to the left.

Panning LFO Initial Position	Description
o F	Off
L t	Left
C t	Centre
R t	Right

EQ Filter

As well as being able to boost low or high frequencies, the final output EQ Filter may be used to create automatic sweeps of EQ and filtering. It may be synchronized to tempo and locked to musical timings from 32nd triplets through to several bars.

EQ Amount

An EQ amount control is provided to give the sound a boost or cut at any chosen frequency. Positive amounts boost the volume of frequencies above the FREQUENCY POINT (see next page) and cut the volume of frequencies below it. Negative

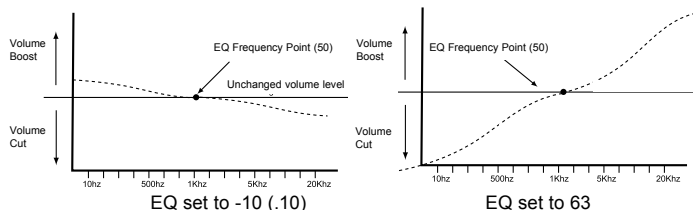

settings do the opposite. To change the EQ amount, ensure the function switch is set to SHIFT. Repeatedly press KEY 4 until the display shows **E A** and an alternating value. Adjust the PORTA/DATA knob for the desired boost / cut.

NOTE: The settings of the EQ FREQUENCY control will determine where in the spectrum the boost / cut appears. Operate this control in conjunction with EQ frequency.

EQ Frequency

The EQ frequency set point determines where in the sound spectrum the boost or cut occurs. It may be moved anywhere from very low frequencies (0 = less than 10Hz) to very high frequencies (127 = above 20,000Hz)

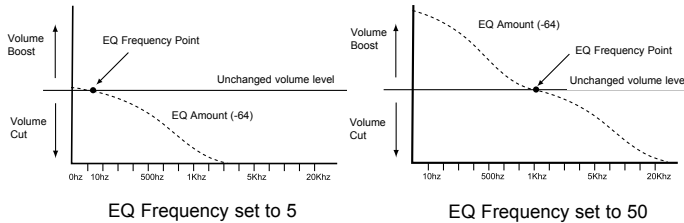

To change the EQ frequency, ensure the function switch is set to SHIFT. Repeatedly press KEY 4 until the display shows **E F** and an alternating value. Adjust the PORTA/DATA knob for the desired EQ frequency.

EQ Depth

The real power of the EQ filter is the ability to move the EQ frequency set point automatically with the dedicated LFO. This control dictates how intense the movements are from the LFO. Any amount of depth will result in EQ changes at the rate determined by the EQ rate control.

To change the depth, ensure the function switch is set to SHIFT. Repeatedly press KEY 4 until the display shows **E d** and an alternating value. Adjust the PORTA/DATA knob for the desired EQ Depth.

EQ Rate

Determines the rate (speed) of the dedicated LFO. This LFO is able to modulate the EQ frequency (see EQ depth). To change the rate, ensure the function switch is set to SHIFT. Repeatedly press KEY 4 until the display shows **E r** and an alternating value. Rotate the PORTA/DATA knob clockwise to increase the rate and anticlockwise to decrease the rate.

EQ Sync

The rate (speed) of the LFO may be locked to the tempo of the musical piece to allow auto EQ Filtering effects. The table on the Page 27 describes the musical timings available.

Set to **o F** and the LFO speed will be at the rate determined by the EQ RATE (see above). Set to any other selection, the LFO speed will be in time with the selected musical timing. This works in similar way to Delay sync (refer to Page 26 for information on setting up this feature).

EQ Initial Position

As well as being able to synchronize to MIDI clock (tempo), the dedicated LFO used to modulate the depth of the EQ may have its initial position set after a specific MIDI event is received such as program change of Start Song (see page 53- Global menu options).

To change the EQ Initial position, ensure the function switch is set to SHIFT. Repeatedly press KEY 4 until the display shows **E k** and an alternating value. The initial positions are shown in the table on the following page. For example, if the desired position is to start moving upwards then set to **L o** (Low). After a MIDI event the LFO wave will start to climb from this low

EQ LFO Initial Position	Description
o F	Off
L o	Low
C E	Centre
H i	High

position. Set to **C E** and it climbs from the centre of the waveform.

Using the EQ Filter Effect

One of the most powerful ways to use this effect is to automatically open and close the filter in time with the musical piece.

The easiest way to listen to this effect is to play a sound with this feature setup. Select a sound (a bright lead or string type sound is ideal for this example).

For this effect, the filter must be set to mimic a low pass filter that opens and closes ('sweeps' up and down the frequency spectrum)

Select the EQ FREQUENCY option (page33) and set it to **5**.

Select the EQ AMOUNT option (Page 32) and set it to **63**.

Play a few notes and listen to the sound. It should be a very muted bassy sound. This is because the EQ filter is cutting most of the frequencies above the set point and boosting those below.

Select the EQ FREQUENCY option again and while playing the keyboard, adjust the value and notice how the sound becomes

brighter as the value increases and softer as the value decreases. Set the EQ FREQ back to **5**.

Select the EQ DEPTH option (Page 33) and set it to **30**.

Select the EQ RATE option and set it to a medium speed.

While playing, notice how the sound automatically becomes brighter and softer in time with the speed of the LFO (If there is no effect, select the EQ SYNC option and make sure it is set to **o F**). The final step is to synchronize this with the musical piece. With a sequencer connected and sending MIDI clock information, (see page 26) set the EQ SYNC to the desired musical timing (See page 27 for listing of timings available).

Vocoder

Vocoder sounds have recently returned to popularity and are being used more frequently in modern Pop and Dance music.

In order to hear a Vocoder sound, recall one of the factory preset sounds (Bank 2 259,269 and 279) and experiment by entering the Vocoder Menu (Press KEY 5 when in SHIFT mode) and tweaking the settings.

All the factory presets require an external audio input such as a microphone to be connected to the external Audio Input jack on the rear panel (See pages 54,55 and 58 for setting up).

To listen to the sound, simultaneously play a connected MIDI keyboard and talk into the microphone (if another input device is being used such as a CD player, then ensure this is playing). The resulting sound will have a Robot or talky like quality to it.

What is a Vocoder ?

Assuming a voice is used via a microphone connected to the external input, the Vocoder superimposes a replica of the voice's energy pattern on to the currently selected sound.

The voice signal known as the *Modulator* is fed to a bank of band pass filters. Each of these filters, 12 of them in the A-Station covers a set band in the audio spectrum from low to high frequencies.

A program (for example a string sound) is known as the *Carrier*. It is routed to another complete set of 12 filters that have the same frequency band settings as the bank of filters used for the voice. Each of the outputs from the 12 band pass filters in the modulator (voice) bank control the volume of each of filters in the carrier bank.

It can now be visualized that, when a low frequency (extracted from the voice by the modulator filter bank) is received by the carrier bank, it passes the low frequency of the selected sound. The other frequencies from the voice are treated in the same way. This process creates the spoken or vocoded effect.

Adding a Vocoder effect to a sound

Ensure the function switch is set to SHIFT. Repeatedly press KEY 5 until the display shows **u d** (Vocoder Balance) and an alternating value. With a microphone or other sound source connected to the input jack (this being the modulator), play a note or chord on the connected MIDI keyboard (this being the carrier). At a setting of 64, a mix of the Modulator and Carrier will be heard - the Vocoder effect. At a setting of 0 the Carrier

Vocoder Menu			
Key 5	Function	Alternating LED Display	
▶ 1st Press	Vocoder Balance	u b	0 - 27.
2nd	Vocoder Sibilance Level	u L	0 - 27.
3rd	Vocoder SibilanceType	u t	h P - n o
4th	Vocoder Stereo Width	u S	0 - 27.
5th			

only will be heard and at a setting of 127 the Modulator only.

Sibilance Level

Determines the amount of sibilance there will be in the vocoded signal. Typically these are the 'S' type of sounds in speech. Adding sibilance gives the Vocoder a more defined sound.

Sibilance Type

Determines if the vocoder uses real sibilance filtered from the modulator or artificially generates it using noise. Set to **h P** and a high pass filter is used to extract the sibilance from the modulator (NOTE: this will allow some of the modulator signal to be heard). Set to **n o** and Noise is used to artificially generate sibilance.

Stereo Width

Determines how wide the stereo output of the vocoder will be. The 12 bands of the Vocoder are panned one by one to the left and to the right. Increasing the value moves the bands further away from the centre position.

Arpeggiator

Arpeggiator

The Arpeggiator breaks down chords into single notes and plays them one at a time. For example, if a 'C' triad chord is held, the notes C, E and G will play one by one in sequence. How the sequence is played is determined by parameters that may be set up in the Arpeggiator menu.

Adding an Arpeggio to a sound

Ensure the function switch is set to SHIFT. Press KEY 6 and the display will show **A c** (Arpeggiator Condition) and an alternating value. Turn the PORTA/DATA knob clockwise until the display reads **o n** (No Latch or Keysync). Play a note or chord on a MIDI controller keyboard and hold the keys down. The sound will now start repeating in a pattern determined by other parameters in the Arpeggiator Menu.

Arp Condition	Description
o F	Off
o n	On - No Latch or Keysync
o K	On - No Latch, Keysync on
o L	On - Latched, No Keysync
o b	On - Latched and Keysync On

Turning the porta/data knob further clockwise will set different Arpeggiator modes as described in the table above. Adjusting fully anticlockwise turns the Arpeggiator off - Display shows **o F**

No Latch or Keysync - o n

The arpeggiator will stop as soon as notes played on a controller keyboard are released. New notes played will not resynchronize the pattern. Experiment by changing modes and playing the keyboard.

No Latch, Keysync On - o K

The Arpeggiator will behave as above, however new notes played will resynchronize the pattern. This mode is useful for certain musical styles.

Latched, No Keysync - o L

This is similar to the **o n** option, however notes will continue to sound even when keys are released on the controller keyboard. To stop the sequence a program change must be made, or the Arp condition set back to option **o F**

Latched and Keysync on - o b

The final option is similar to **o K**, except that notes will continue to sound even when keys are released on the controller keyboard. Repeated presses of KEY 6 will move through the Arpeggiator menu as described in the table opposite.

Arpeggiator Rate

Sets the speed at which the Arpeggiator sweeps through its patterns. Fully anticlockwise and the Arpeggiator will step through a sequence at 64 beats per minute (Display shows **64**). Clockwise movement increases speed. The max speed range is 191 b.p.m. indicated by **91**.

Arpeggiator Menu			
Key 6	Function	Alternating	LED Display
▶ 1st Press	Arp Condition	A c	o F - o b
2nd	Arp Rate	A r	64 - 91.
3rd	Arp Oct Range	A o	1 - 4
4th	Arp Gate Time	A g	0 - 27.
5th	Arp Pattern	A P	u P - r d
6th	Arp Sync	A y	oF - 2b
7th	Arp Note Destination	A d	In - Et - IE - EP
8th			

Arpeggiator Range

Set how many octaves the Arpeggiator will sweep through. The sweep range is selectable from 1 to 4 octaves.

Arpeggiator Gate Time

Sets the gate time or duration of the notes being played by the Arpeggiator. Small values of gate time produce a Staccato effect. Large values produce a Legato effect. Anticlockwise and the gate time is very short, clockwise and the gate time is long.

Arpeggiator Pattern

Determines the type of Pattern the Arpeggiator will use. Six patterns are available from **Up** to **Random**. Use the PORTA/DATA knob to select the desired pattern.

u P - UP The arpeggio starts at the lowest note played and sweeps up through the notes until it reaches the highest note. It then starts at the bottom again and repeats the sequence.

d n - DOWN The arpeggio starts at the highest note played and sweeps down through the notes until it reaches the lowest note. It then starts at the top again and repeats the sequence.

U d - UP/DOWN The arpeggio starts at the lowest note played and sweeps up through the notes until it reaches the highest note. It then sweeps back down. This is useful when playing three notes in songs with a 3/4 time signature.

u d - UP/DOWN2 The arpeggio starts at the lowest note played, plays it twice, and sweeps up through the notes until it reaches the highest note. It then plays the top note again and sweeps back down.

L p - LAST NOTE PLAYED The arpeggio plays the last note played in sequence. Once at the end of the notes played it repeats the sequence.

r d - RANDOM Notes played will be arpeggiated in a random order.

NOTE: It is possible to control the Arpeggiator Latch On/Off from an external Computer/Sequencer. Transmit Midi controller number 64 with a value of 127 to turn the Arpeggiator latch **On** and transmit controller number 64 with a value of 0 to turn the latch **Off**.

Arpeggiator

Arpeggiator Sync

Allows the Arpeggiator to be synchronized with an external sequencer. A range of synchronization values are available as shown in the table below.

Arpeggiator Sync to MIDI Clock table

Display	MIDI Clocks	Synchronised to
o F	-	Manual Rate
3 t	2	32nd Triplet
3 2	3	32nd
6 t	4	16th Triplet
1 6	6	16th
8 t	8	8th Triplet
6 d	9	16th Dotted
8	12	8th
4 t	16	4th Triplet
8 d	18	8th Dotted
4	24	4th
2 t	32	2nd Triplet
4 d	36	4th Dotted
2	48	2nd
1 t	64	1 Bar Triplet
2 d	72	2nd Dotted
1 b	96	1 Bar

When a sync interval is selected, the tempo of the Arpeggiator is controlled by the Arpeggiator Rate setting (page 36) when **MIDI Clock Source** is set to **i** - internal - or by the external sequencer's tempo when **MIDI Clock Source** is set to **e** - external - See Page 52 for information on setting the Global **MIDI Clock Source**.

Arpeggiator Destination

For flexibility, the Arpeggiator output may be routed to a number of destinations. Setting the Arpeggiator destination to **In** (Internal) routes the Arpeggiated notes to the internal sound engine. This could be considered as the normal mode of operation. There will be no Arpeggiated notes output from the MIDI out socket using this setting.

Setting the destination to **Et** (external) will route the Arpeggiated notes ONLY to the MIDI output socket. *Please note:* There will be no sound from the A-Station rack's own sound engine when this option is selected.

Setting the destination to **IE** (internal and external) will route Arpeggiated notes to both the MIDI output socket and the internal sound engine.

Setting the destination to **EP** (External and Played) will route the Arpeggiated notes to the MIDI output socket but in addition the A-Station sound engine will just play the notes as received (not arpeggiated) from an external MIDI keyboard or controller device.

Oscillators

Oscillators

To complement the front panel controls in the Oscillator section there are many other parameters located in the Oscillators menu - KEY 7

Setting the Oscillators to play in Unison

Unison mode allows more than one voice to be used for each note played. This effect is useful when a very thick sound is required. The A-Station allows up to eight voices to sound layered one on top of another when just a single note is played.

To listen to the effect, ensure the function switch is set to SHIFT. Press KEY 7 and the display shows **u n** (Unison Number) and an alternating value. Turn the PORTA/DATA knob clockwise until the display shows **2**. Play a note and listen to the sound. It will become thicker sounding. Increasing the number of notes to a maximum of 8 will result in very dense sounding textures. NOTE: As voices are used, the polyphony will reduce, for example using 8 voices in Unison mode will result in just one note of polyphony!

Unison Detune Amount

Unison Detune Amount is used in conjunction with Unison mode as described above. When using more than one voice per note the Unison detune amount sets how much each voice is detuned relative to the others. Adjust the amount until the desired effect is heard.

VCO Drift

Controls the amount of tuning drift for the Oscillators. Setting a modest value, 10 for example will cause each Oscillator to

Oscillator Menu				
Key 7	Function	Alternating	LED Display	
1st Press	Unison	u n	o F - 8	
2nd	Unison Detune	u d	0 - 27.	
3rd	VCO Drift	d r	0 - 27.	
4th	Osc 1,2,3 Preglide	P g	12. - 12	
5th	Oscillator Start Phase	o P	o F - 14	
6th	Osc 2 - 3 FM Manual Level	F L	0 - 27.	
7th	Osc 2 - 3 FM Env Amt	F E	64. - 63	
8th	FM Env Attack	F A	0 - 27.	
9th	FM Env Decay	F d	0 - 27.	
10th				

slowly drift fractionally out of tune. Classic Analogue Synthesizers were known to gradually go out of tune as the internal circuits heated up. This helped to give them their own unique character.

Oscillator Preglide

A Preglide is applied to the pitch of the Oscillators starting at a pitch determined by the Preglide amount in semitones. Gliding up from a pitch occurs when the display indicates between **.12 - 1** (minus 12 to minus 1 semitones) and gliding down from a pitch occurs when the display indicates **1 - 12.** (plus 1 to plus 12 semitones) The time it takes to complete the Glide is determined by the Portamento time knob on the front panel. The Preglide is triggered with every note received.

Oscillator Start Phase

When synthesizing percussive or plucked type sounds, where there is a lot of detailed waveform information at the beginning of the sound, it is often useful to have the Oscillator wave start in *exactly* the same place every time a key is pressed.

The start phase option allows the precise starting point of the Oscillator wave to be determined. At zero, the wave will start at zero Degrees. Each increment on the display shifts the start point of the wave approximately 24 degrees. The wave will start at a random phase when set to **o F** (off).

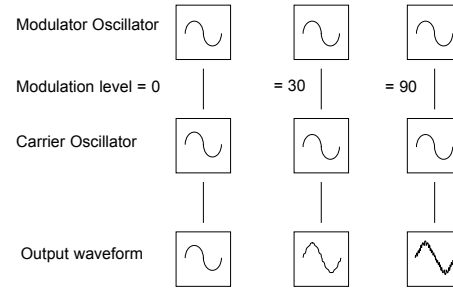

FM Synthesis.

The next four menu options allow sounds based on FM (Frequency Modulation) synthesis to be created. Before looking at the operations of these controls, a little explanation of FM synthesis follows.

Earlier in this manual, the basics of subtractive synthesis were introduced. Terms such as harmonics, timbre, waveforms and oscillators became familiar.

FM Synthesis is the technique of using *one waveform to Frequency Modulate - FM- another to produce a resultant more harmonically complex waveform.*

The following diagram illustrates that the higher the modulation between the Modulating wave and the Carrier wave, the more the waveform changes. In this illustration the Oscillators are producing Sine waves. It is the *change* in harmonics over time that makes a sound interesting to our ears. In FM synthesis, an envelope generator is inserted between the modulator and carrier waveforms so that there is control over of how much of the

frequency modulation is taking place with respect to time. Adding this envelope constructs the basic FM building block as illustrated below.

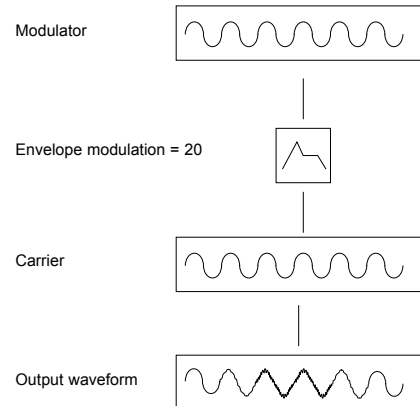

Oscillators - FM Synthesis

Referring to the diagram on the last page, it can be seen that the output waveform begins the same as the carrier, and becomes more complex (harmonics are added) as the amount of FM modulation increases via the envelope. It then returns to a simple wave again as the envelope decays.

The timbre of the Waveform is changing with time. This is the opposite of subtractive synthesis where a *low pass Filter* is used to *remove harmonics*.

To complete a simple synthesizer, a further envelope is added to control the output volume.

The complete FM building block is illustrated below.

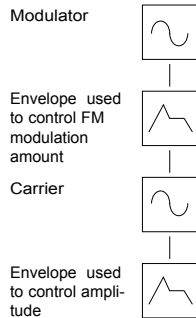

Programming FM sounds

OSC 2 is able to FM OSC 3 via a dedicated FM envelope. The diagram below shows in block diagram format how the A-Station can produce FM sounds.

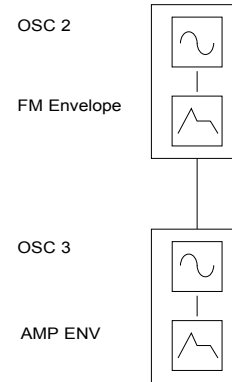

The easiest way to be totally familiar with FM is to take one of the factory preset FM sounds, for example Bank 2 - 49 (Sound 249) and modify it.

Setting OSC 2 - 3 manual FM amount

Ensure the function switch is set to SHIFT. Repeatedly press KEY 7 (Oscillator Menu) until the display shows **FL** (Osc 2-3 Manual Level) and an alternating value. Whilst playing a note, adjust the PORTA/DATA knob. Notice that increasing amounts of modulation level make the sound more metallic.

Setting the OSC 2 - 3 FM Envelope Amount

Many sounds have complex harmonic movements at the start of the sound. Introducing envelope modulation from an envelope with a fast attack and decay time to control the FM amount will simulate this fast changing harmonic effect.

Once in the Oscillator Menu (see previous page), a further key press will enter the OSC 2 - 3 Envelope Amount settings. The display will show **F E** and an alternating value. Adjust this value using the PORTA/DATA knob. Notice how the 'spit' at the beginning of the sound may be accentuated. Experiment with Oscillator 2 pitch using the OCTAVE switch, SEMITONE and DETUNE knobs.

Adjusting the FM Envelope Attack and Decay times

Assuming the the Oscillator Menu is selected and FM Envelope Amount was the last selected item, a further key press will enter the FM envelope attack time options. The display will show **F A** and an alternating value. Adjust this value using the PORTA/DATA knob.

A further press will select the FM envelope decay time options. The display will show **F d** and an alternating value. Adjust this value using the PORTA/DATA knob.

Pitch and Modulation wheels

Responding to Pitch and Modulation Wheel Data

The A-Station will respond to Pitch and Modulation wheel information from a MIDI keyboard. The response is set using the Wheels Menu - KEY 8.

Setting up a Pitch change when pushing a wheel forward

Press KEY 8 (ensure the function switch is in SHIFT mode) and the display will show **b 1** alternating with a numeric value. The value indicates how many semi-tones the pitch will change for Oscillator 1 when moving the pitch wheel.

Adjust the PORTA/DATA knob until the desired number of semi-tones is displayed. This affects the current program being listened to. Display values 1-12 will result in a higher pitch when the wheel is pushed forward. Display values -1 - .12 will result in a lower pitch.

Subsequent key presses of Key 8 will scroll through the Wheels menu as described in the table opposite.

NOTE: If the current program uses more than one Oscillator, it is recommended that the bend amount is set equal for each Oscillator. If chord type effects are required when moving the pitch wheel, different pitch bend amounts may be set for each Oscillator.

Changing the Absolute Pitch using the Modulation Wheel

During performance it may be desirable to drastically change the pitch of all the Oscillators using the Modulation Wheel. Repeatedly press KEY 8 (ensure

the function switch is in SHIFT mode) until the display shows **P A** alternating with a numeric value. Adjust the PORTA/DATA knob. A value from -1 to 64. will result in a lower pitch being generated when the mod wheel is pushed forward. A value from 01 to 63 will result in a higher pitch being generated when the mod wheel is pushed forward.

Setting up Vibrato using the Modulation Wheel

During a performance it is often desirable to introduce a Vibrato effect by pushing the Modulation Wheel forwards or backwards.

A Vibrato effect is simulated by adding a small amount of pitch modulation to the Oscillators. The A-Station allows modulation from LFO 1 to alter the pitch of the Oscillators. Repeatedly press KEY 8 (ensure the function switch is in SHIFT mode)

Wheels Menu				
Key 8	Function	Alternating LED Display		
→ 1st Press	Osc 1 Pitch Bend Amt	b 1	12.	- 12
2nd	Osc 2 Pitch Bend Amt	b 2	12.	- 12
3rd	Osc 3 Pitch Bend Amt	b 3	12.	- 12
4th	Osc 1,2,3 Absolute Pitch Amt	P A	64.	- 63
5th	Osc 1,2,3 Pitch Mod (LFO1) Amt	P L	64.	- 63
6th	Filter Cut Off Absolute Freq Amt	F A	64.	- 63
7th	Filter Cut Off Freq Mod (LFO2) Amt	F L	64.	- 63
8th	Amplifier Level	A L	64.	- 63
9th				

until the display shows **P L** alternating with a numeric value. Adjust the PORTA/DATA knob. A positive value (1 - 63) will introduce a pitch shift in time with LFO 1. If LFO 1 is set to a sawtooth wave then the pitch will climb, then rapidly return to the base pitch.

A negative value (-1 - .64) will result in the pitch falling then rapidly returning to the base pitch. To achieve the vibrato effect, set the LFO 1 waveform to triangle. Since this waveform is symmetrical, it does not matter if positive or negative modulation is used. Adjust the speed of the LFO until the vibrato is satisfactory.

Opening or closing the Filter using the Modulation Wheel

The filter Cut off frequency may be raised (opening the filter) or lowered (closing the filter) directly from the modulation wheel on a MIDI controller keyboard.

Press KEY 8 (ensure the function switch is in SHIFT mode) until the display shows **F A** alternating with a numeric value. Adjust the PORTA/DATA knob. A positive value (1 - 63) will open the Filter when the Mod wheel is pushed forward. A negative value (.1 - .64) will close the Filter when the Mod wheel is pushed forward.

Setting up a Wow WoW effect using the Modulation Wheel.

Sending a small amount of triangle LFO modulation to the Filter will simulate the popular Wow Wow effect. Repeatedly press KEY 8 (ensure function switch is in shift mode) until the display shows **F L** alternating with a numeric value. Adjust the PORTA/DATA knob. A positive value (1 - 63) will open the filter

in time with LFO 2 above the basic Cut off frequency. A negative value (-1 - .64) will close the filter in time with LFO 2 below the basic Cut off frequency.

Controlling the Volume from the Modulation Wheel.

By routing the Modulation wheel to the amplifier, the overall volume of the sound may be controlled.

Repeatedly press KEY 8 (ensure the function switch is in SHIFT mode) until the display shows **A L** alternating with a numeric value. Adjust the PORTA/DATA knob. A positive value (1 - 63) will increase the volume when the Mod wheel is pushed forward. A negative value (-1 - .64) will reduce the volume when the Mod wheel is pushed forward.

Aftertouch and Breath Control

Responding to Aftertouch and Breath Control Data

The A-Station will respond to Aftertouch information from a MIDI keyboard and Breath Control from from a Breath Controller. The response to this information can be set using the Aftertouch, Breath Menu - KEY 9.

Changing absolute pitch using Aftertouch or Breath control

Press KEY 9 (ensure the function switch is in SHIFT mode) the display shows **A P** (for Aftertouch adjustment) or with 5 more key presses **b P** (for Breath control adjustment) alternating with a numeric value. Adjust the PORTA/DATA knob. A value from -1 to .64 will result in a lower pitch being generated when aftertouch or breath control is received. A value from 1 to 63 will result in a higher pitch being generated when Aftertouch or Breath control is received.

Setting up a vibrato effect using Aftertouch or Breath Control

Repeatedly press KEY 9 (ensure the function switch is in SHIFT mode) - the display shows **A L** (for Aftertouch adjustment) or with 5 more key presses **b L** (for Breath control adjustment) alternating with a numeric value. Adjust the PORTA/DATA knob to a positive value (1 - 64). This will introduce a pitch shift in time with LFO 1 raising and lowering the basic pitch of the note.

Note : Ensure the Waveform of LFO 1 is set to triangle

Opening or closing the Filter using Aftertouch or Breath Control

The filter Cut off frequency may be raised (opening the filter) or lowered (closing the filter) directly from Aftertouch or Breath control. Repeatedly press KEY 9 (ensure the function switch is in SHIFT mode) until the display shows **A F** (for Aftertouch adjustment) or with 5 more key presses **b F** (for Breath control adjustment) alternating with a numeric value. Adjust the PORTA/ DATA knob. A positive value (1 - 63) will open the Filter when Aftertouch or Breath control is received. A negative value (.1 - 64.) will close the Filter when Aftertouch or Breath control is received.

Aftertouch..Breath.. Menu

Key 9	Function	Alternating LED Display
1st Press	Aftertouch to Osc 1,2,3	Absolute Pitch A P 64. - 63
2nd	Aftertouch to Osc 1,2,3	LFO 1 Mod Amt A L 64. - 63
3rd	Aftertouch to Filter	Absolute Freq A F 64. - 63
4th	Aftertouch to Filter	LFO 2 Mod Amt A n 64. - 63
5th	Aftertouch to Amplifier	Level A A 64. - 63
6th	Breath to Osc 1,2,3	Absolute Pitch b P 64. - 63
7th	Breath to Osc 1,2,3	LFO 1 Mod Amt b L 64. - 63
8th	Breath to Filter	Absolute Freq b F 64. - 63
9th	Breath to Filter	LFO 2 Mod Amt b n 64. - 63
10th	Breath to Amplifier	Level b A 64. - 63
11th		

Setting up a Wow Wow effect using Aftertouch or Breath Control.

Move the function switch to SHIFT and press KEY 9 four times. The display shows **A n** (Aftertouch adjustment) or with five more presses, **b n** (Breath control adjustment) alternating with a numeric value. Adjust the PORTA/DATA knob clockwise to a positive value (1 - 64). This setting will open and close the filter in time with LFO 2.

Note: Ensure the Waveform of LFO 2 is set to triangle

Setting the Volume of the Amplifier using Aftertouch or Breath Control.

Repeatedly press KEY 9 (ensure function switch is in shift mode) until the display shows **A A** (Aftertouch adjustment) or **b A** (Breath control adjustment) alternating with a numeric value. Adjust the PORTA/DATA knob. A positive value (1 - 63) will increase the output volume of the Amplifier Envelope. A negative value (-1 - .64) will decrease the output volume of the Amplifier Envelope.

Note: When Using Aftertouch and Breath control features, check that the MIDI controller device being used is able to transmit Aftertouch or Breath control information.

Note: In order to hear the effect of any of these settings, press a key on the MIDI controller, or blow into the breath controller while adjusting the parameters.

Velocity, Triggering and Synchronization Control

Powerful synchronization and triggering options are available through the KEY 0 Menu. The table below illustrates the options available in the menu.

Vel..Trig..Sync Menu			
Key 0	Function	Alternating LED Display	
▶ 1st Press	Velocity to Amp Env Level	u A	64. - 63
2nd	Velocity to Mod Env Level	u E	64. - 63
3rd	Velocity to FM Env Level	u F	64. - 63
4th	Voice Mode	n n	n A - P 2
5th	Porta Type	P t	E L
6th	Envelopes Triggering Type	E t	n E - b E
7th	Enable External Triggering	E E	o F - E d
8th	LFO's Delay Triggering	L d	n L - b L
9th	LFO 1 Lock and Sync Control	L 1	-- - k O
10th	LFO 2 Lock and Sync Control	L 2	-- - k O
11th	LFO 1 Midi Clock Sync	y 1	o F - 12
12th	LFO 2 Midi Clock Sync	y 2	o F - 12
13th			

Responding to velocity information from a Controller keyboard

The Amplifier Envelope, the Mod Envelope and the FM Envelope can respond to Velocity information. The response to this information is set using the first three options in this menu

Velocity - Triggering - Synchronisation

Setting up a sound to make its volume respond to velocity

Press KEY 0 (ensure the function switch is in SHIFT mode) and the display will show **u A** alternating with a numeric value. Adjust the PORTA/DATA knob. At a setting of zero a soft key stroke will produce a sound at the same volume as a hard key stroke. At a maximum positive value (63) soft key strokes will be much quieter than hard key strokes. At a maximum negative value (.64) soft key strokes will be much louder than hard key strokes.

Setting up a sound to make its brightness or pitch respond to velocity

Repeatedly press KEY 0 (ensure the function switch is in SHIFT mode) until the display shows **u E** alternating with a numeric value. Adjust the PORTA/DATA knob. Turn the FILTER FREQUENCY knob to a near zero setting or until the sound almost disappears. Turn the MOD ENV DEPTH knob in the Filter section to maximum clockwise.

In the Envelopes section, Set the MOD ENV ATTACK and SUSTAIN knob to zero and the DECAY knob to nearly full. While playing notes on a MIDI Keyboard, Adjust the PORTA/DATA knob. At a setting of zero there will no effect on the brightness of the sound.

At maximum positive value (63) soft key strokes will produce a tone much softer than hard key strokes. At a maximum negative value (.64) soft key strokes will produce a tone much brighter than than hard key strokes. To affect the pitch, adjust the MOD ENV knob in the Oscillator section.

Select a factory preset FM sound (such as 209) Repeatedly

Adjusting the Velocity Response of the FM Envelope

press KEY 0 (ensure the function switch is in SHIFT mode) until the display shows **u F** alternating with a numeric value. Adjust the PORTA/DATA knob. Notice how the FM effect at the start of the sound becomes dependent on how hard the keys are struck.

Voice Mode

Interpretation of new MIDI notes received is set using the Voice Mode option in the Triggering menu.

Mono Mode - n A For emulating sounds that are naturally monophonic, Mono mode is available. In this mode *only one voice* is used. When a new note is received, the current voice is truncated and re-run with the new pitch information.

Autoglide - A G A special mode where, only one voice is used but there must be a gap in between notes played in order for both Envelopes to re-trigger. Overlapping notes *will not trigger* either Envelope. If Portamento is applied to the sound, it will only be active when notes are overlapped. This mode allows TB303* type sounds to be easily programmed.

Poly 1 Mode - P 1 A new voice is allocated to every new note received even if a voice is already active at the same pitch. This is the standard polyphonic mode and is how most modern synthesizers allocate voices.

Poly 2 Mode - P 2 When a new note is received, any active voices at the same pitch will be soft triggered (re-used). This is how many vintage 6 or 8 voice analogue synthesizers allocated voices.

Voice Mode	Description
n A	Mono No Auto Glide
A G	Mono with Autoglide
P 1	Poly 1
P 2	Poly 2

Changing the Voice Mode

Repeatedly press KEY 0 (ensure the function switch is in SHIFT mode) until the display shows **n n** and an alternating value. The table above illustrates the modes according to the letters displayed. Use the PORTA/DATA knob to change the mode.

Portamento Type

When PORTAMENTO is applied to a sound, the slow change in pitch from one note to the next may be at a linear or exponential rate. Experimentation with this parameter is recommended for different playing styles. To change the type, repeatedly press KEY 0 (ensure function switch is in shift mode) until the display shows **P t** alternating with either **E** or **L**. Use the PORTA/DATA knob to change the mode.

Envelope Triggering Types (Mono mode only)

When the Voice mode is set to any of the Mono options, different envelope triggering options are available for legato playing styles (notes overlapping). When the first note of a musical phrase is played, it might be desirable to have both the

Amplifier and Filter envelopes trigger. For the remaining legato notes, just the filter envelope re-triggering would create the effect of the phrase becoming quieter and quieter.

Changing the Envelope Triggering Type (Mono mode only)

Repeatedly press KEY 0 (ensure function switch is in shift mode) until the display shows **E t** and an alternating value. The table below illustrates the modes according to the letters displayed. Use the PORTA/DATA knob to change the mode.

Env's Trig Type	Description
n E	None
A E	Amp Env Only
F E	Mod Env and FM Only
b E	Amp Env, mod Env & FM Env

Envelope Auto Triggering from External Audio Input

The external audio triggering menu option determines how the external audio signal is processed. To change the settings, repeatedly press KEY 0 (ensure function switch is in shift mode) until the display shows **E E** and an alternating value. Rotate the PORTA/DATA knob until the value changes to the required selection as shown in the table on the following page. The option **E d** will send the signal direct to the effects processor.

External Audio Trig	Description
o F	Triggering Disabled
t r	Triggering Enabled
F d	Ext Audio fed Direct to Effects

For more information on setting up and triggering from an external audio input signal, see page 52.

LFO Delay Triggering

When the Voice mode is set to any of the Mono options, different LFO delay settings are available for legato playing styles

LFO's Delay Trig Type	Description
n L	None
1 L	LFO 1 only
2 L	LFO 2 Only
b L	Both LFO's

(notes overlapping). When the first note of a musical phrase is played it might be desirable to have an initial delay on LFO 1. (If LFO is routed to pitch modulation, a vibrato effect would be introduced after the delay time). For the remaining legato notes, a non interrupted vibrato might be required.

Changing the LFO Delay Triggering (Mono mode only)

Repeatedly press KEY 0 (ensure function switch is in shift mode) until the display shows **L d** and an alternating value. The table opposite illustrates the options according to the letters displayed. Use the PORTA/DATA knob to change the mode.

LFO1 and LFO2 Locking and Key Sync

Both LFO 1 and LFO 2 may be locked or synchronized to Key presses.

Locking the LFOs

Each of the eight voices have two LFO's - sixteen in total. The eight LFOs designated LFO 1 (one per voice) may be 'phase' locked together and similarly the eight LFO's designated LFO 2 may be locked.

To illustrate this, assume the LFO waveform is a triangle wave and at a specific moment in time all eight are at the beginning of a the rising portion of the wave. At a later point in time all will be at the beginning of the falling portion of the wave. If this waveform is applied to pitch, when a number of notes are played simultaneously, the pitch of all the notes will rise and fall at precisely the same time.

If the LFO is not locked, then each wave will be at a random position relative to the others. In this pitch modulation example, the pitch of all the notes will be changing 'out of synchronization' with others.

Imagine a String section of eight violin players. With the LFO locked and the LFO being used to create a vibrato. All eight of the string players would have the bow in exactly the same position. This obviously does not occur in a real string section and if it did the sound would be very unusual. In reality each player's bow would be in a different position which gives the strings a 'chorus' type sound. To simulate the string section the LFOs would not be locked.

Key Synchronization.

Each LFO may be restarted every time a key is pressed. For example, if a siren type sound effect was required, an LFO using a sawtooth wave would be set to positively modulate pitch. Each time a new key is pressed the pitch would climb from the same point rather than being at an undetermined pitch position.

LFO's	Lock and Sync	Description
-	-	No Keysync No Lock
k	-	Keysync'd, No Lock
k	o	Keysync'd with offset, No Lock
-	L	No Keysync, Locked
k	L	Keysync'd, Locked *
k	O	Keysync'd with offset, Locked

Changing LFO1 and LFO2 Locking and Key Sync

Repeatedly press KEY 0 (ensure function switch is in shift mode) until the display shows **L 1** (for LFO1) or **L 2** (for LFO 2) and an alternating symbol. The table opposite illustrates the options according to the letters displayed. Use the PORTA / DATA knob to change the mode.

LFO1 and LFO2 Midi Clock Synchronization

Both LFOs may be locked to MIDI Clock. As an example, a very pleasing audio effect may be achieved when an LFO is modulating the filter cut off frequency and this is synchronized to the tempo of amusical piece.

To synchronize an LFO, repeatedly press KEY 0 (ensure the function switch is in SHIFT mode) until the display shows **y 1** (for LFO 1) or **y 2** (for LFO 2) and an alternating value. Rotate the PORTA/DATA knob until the desired musical timing value is displayed according to the table on Page 27.

This works in a similar way to Delay sync. Refer to Page 26 for information on how to set this up for use with an external sequencer or computer.

Utility Mode - Global Menu - Master tuning - Local On / Off

Utility Mode

General functions that are common to the whole machine rather than program specific are accessed by the GLOBAL MENU.

To access the GLOBAL menu, UTILITY MODE must be selected. Press the MODE SELECT button until the UTILITY LED is lit.

Pressing KEY 0 now enters the GLOBAL menu. The functions available with subsequent key presses are listed in the table below.

	Utility Mode	Global Menu
Key 0	Function	Alternating LED Display
▶ 1st Press	Tuning - Cents	t u 50. - 50
2nd	Local	L o of - on
3th	Midi Clock Source	c S i - e
4th	Midi Clock Inspector	c i - - 96
5th	Clock Sync Type	S t PC - SS
6th	Pot Display Persistence	P P 0 - 27.
7th	Velocity Curve	u c S t - H d
8th	Menu Initial Display	i d oF - on
9th	Input Sensitivity	i S Lo - HI
10th	Input Trim	i t 10. - 20
11th	Input Trig Sensitivity	i L 0 - 27.
12th		

Adjusting the Master Tuning

Ensure the MODE is set to UTILITY - Repeatedly press KEY 0 until the display shows t u (Global Tuning) and an alternating value.

The A-Station is preset at the factory with the display indicating 0 0. The zero value indicates there is no tuning offset. Playing the note 'A' above middle 'C' will produce a pitch of 440Hz. Turn the PORTA/DATA knob, the value on the display will indicate an offset in cents from this pitch. Negative offsets are displayed with a minus before the numeric value or a dot after.

Setting Local On - Off

The knobs on the A-Station will transmit MIDI controller data that may be recorded by a sequencer. This feature allows a sequencer, when in playback mode to send MIDI controller data which has the effect of adjusting knob values. Although there is no physical movement of the knobs, the sound will be manipulated in real time according to the controller data values.

NOTE: To prevent a MIDI data conflict arising when knobs are being adjusted and data being is received from a sequencer when there is a complete MIDI loop, LOCAL OFFf must be selected. If there is no MIDI loop LOCAL ON must be selected

See page 58 for a typical MIDI connection diagram where there is a loop and setting to LOCAL OFF would apply.

Ensure the MODE is set to UTILITY - Repeatedly press KEY 0 until the display shows L o (Local) and an alternating value. Turn the PORTA/DATA knob, to switch between off and on (o F and o n).

MIDI Clock Source

The A-Station requires a master timing clock in order to determine the tempo (rate) of the arpeggiator and to provide a time base for synchronization to other musical timings. This clock may be derived internally or received from an external device that is able to send a master timing clock (This is often known as a MIDI clock).

If synchronization to external events is not required, then setting this Master clock source to *Internal* is recommended. Set to internal, the Arpeggiator Rate (adjustable in the Arpeggiator Menu) sets the speed of the clock in Beats per Minute (B.P.M.).

To change from internal to external clock, press the MODE SELECT button until the UTILITY LED is lit. Repeatedly press KEY 0 until the display shows **c S** (Clock Sync) and an alternating value. Set to **e** (external) by turning the PORTA/DATA knob. The tempo that the Arpeggiator and any synchronisation will lock to will now be dictated by the MIDI clock being sent by an external sequencer. To change back to Internal, turn the PORTA/DATA knob until the display indicates **i**.

MIDI Clock Synchronization Type

If the MIDI clock source is set to external, a clock synchronization type may be selected. This allows a MIDI event, either *first note played after program change* or *MIDI Start Song Message* to synchronize the Panning, EQ Filter and Chorus LFO's. They may have their start position locked in time with the musical piece for stunning effects.

Clock Sync Type	Description
P C	First note after program chg
S S	Midi Start Song Msg

To change the clock sync type, press the MODE SELECT button until the UTILITY LED is lit. Repeatedly press KEY 0 until the display shows **S t** (Sync Type) and an alternating value. Set to **P C** for first note after Program Change or **S S** for Start Song Message by turning the PORTA/DATA knob.

MIDI Clock Inspector

It is possible to see if an external device is sending a MIDI clock by using the MIDI Clock inspector. This is useful for trouble shooting. Press the MODE SELECT button until the UTILITY LED is lit. Repeatedly press KEY 0 until the display shows **C i** (Clock Inspector) If an external clock is being received, the display will indicate the tempo of the external clock. If not - - will be displayed.

Knob value display time

In normal operation, when the front panel knobs are adjusted, the LED display momentarily switches from displaying the Program number, to displaying the value of the parameter being adjusted. It then switches back to displaying the Program number. The length of time that the adjusted parameter is displayed before switching back, may be set in this menu option.

Press the MODE SELECT button until the UTILITY LED is lit.

Global Menu - Velocity Curve - Display Menus - External Audio Input

Repeatedly press KEY 0 until the display shows **P P** (Potentiometer Persistence). To increase the display time of the adjusted value, turn the PORTA/DATA knob clockwise, to reduce the time, turn anticlockwise. A setting of **0 0** will inhibit the display from showing parameter values when knobs are adjusted.

Velocity Curve

The response to MIDI velocity information from an external device such as a MIDI controller keyboard or a sequencer may be set using this option. Press the MODE SELECT button until the UTILITY LED is lit. Repeatedly press KEY 0 until the display shows **u C** (Velocity Curve) and an alternating value.

Velocity Curve	Description
S t	Soft
H d	Hard

A setting of **S t** (Soft) indicates that smaller changes in velocity, a lighter playing style, is required to create a large change in response to velocity, be it volume or any other parameter that velocity routed to. A setting of **H d** (Hard) indicates that higher changes in velocity - a much harder playing style, is required to create large changes in response to velocity.

Operation of the Display Menus

The display menus (including this one) can operate in two different modes. The first mode (factory default setting) specifies that each time a new menu key is pressed, the *first item in the*

menu list is always selected. For example pressing KEY 2 - Reverb, after KEY 3 Chorus, will result in always selecting Reverb level. The second mode specifies *that the last used item in the menu list for a KEY is selected.* For example, if Reverb Decay is being adjusted - KEY 2, and the Chorus button is pressed - KEY 3, a subsequent press of KEY 2 will result in Reverb Decay being the menu item selected.

Press the MODE SELECT button until the UTILITY LED is lit. Repeatedly press KEY 0 until the display shows **i d** (Initial Display) and an alternating value. Adjust the PORTA/DATA knob. The display will switch from **o F** (first mode) to **o n** (second mode).

Using the External Audio Input

In order to use an external audio input, the A-Station must be set up to correctly to respond to the level (amplitude) of the incoming signal. Since the levels of these signals can vary substantially, the Global menu option, Input Sensitivity and Input Trim must be adjusted for optimum performance. This will minimize distortion and noise.

Adjusting the Input Sensitivity of the External Audio In

Connect the input device to the rear panel jack labeled INPUT. Repeatedly press the MODE SELECT button until the UTILITY LED is lit. Repeatedly press KEY 0 until the display shows **i S** (Input sensitivity) and an alternating value. When connecting devices such as CD's Turntables, Mixing desks or other line level equipment, set the sensitivity to **L o**. Set to **H I** for devices such as Guitars or Microphones.

Once set, play (or talk into the microphone), the column of LEDs to the right of the display should now respond to the level of the signal. It is likely that they will either all illuminate or just the lowest one or two in the column. The 'Input Trim' must now be set to optimize performance.

Input Sensitivity	Description
L o	Low Gain
H I	High Gain

Adjusting the AudioTrim for External Signals

After Input Sensitivity is set - see above, the sensitivity must be 'trimmed' for best performance. Ensure the MODE is set to UTILITY. Repeatedly press KEY 0 until the display shows **i t** (Input Trim) and an alternating value. Whilst the input signal is present adjust the PORTA/DATA knob until the all the LEDs except the very top one - PROGRAM - frequently light. The sensitivity level is now set correctly.

In order to hear the external signal through the effects processor or to make the signal trigger sounds, the current PROGRAM selected has to have external audio enabled (see page 50).

Setting an External Audio Signal to Trigger the Envelopes

Once the input sensitivity has been set for the input device (see above) set the SOURCE switch in the Mixer section on the front panel to EXT and turn up the LEVEL. Before adjusting the *threshold* (how loud the external signal has to be before it trig-

gers the envelopes) check that the specific program has its triggering options enabled for external audio.(Set Triggering Option **E E** to **E n** in the KEY 0 Vel..Trig..Sync Menu.. (see page 49)

Adjusting the Audio Input Auto triggering Sensitivity

Ensure the MODE is set to UTILITY. Repeatedly press KEY 0 until the display shows **i L** (Input Trigger Level) While playing the external audio input device (or talking into the microphone), adjust the PORTA/DATA knob until the external audio signal is heard at the output. If there is no output, check that the Envelope controls are set to sensible levels and that the Filter FREQUENCY is fully clockwise.

If any of the Oscillator volumes are turned up (Mixer section) a default middle 'C' note will be heard even when there is no MIDI input. If this is undesirable, then reduce the volumes of all the Oscillators.

Using External Audio Direct to Effects

The external audio signal may be fed directly to the effects bypassing the Mixer, Filter and Envelopes. Once the input sensitivity has been set for the input device (see previous page) set the SOURCE switch in the Mixer section on the front panel to EXT and turn up the LEVEL. Set the Triggering Option **E E** to **F d** in the KEY 0 Vel, Trig, Sync Menu, (see page 50) The external signal should now be heard at the outputs. It may now be processed by all the effects including the EQ Filter.

Utility Mode - Backing up sounds - Restoring factory preset sounds

Sending (Backing Up) sounds to an external device

Remaining KEYS in the UTILITY MENU are used for sending PROGRAMS (backing up) to external storage devices and for restoring factory preset programs. Press the MODE SELECT button until the UTILITY LED is lit.

Util Mode	
Key Number	Function
0	Global Menu
1	Send Bank 1 Programs
2	Send Bank 2 Programs
3	Send Bank 3 Programs
4	Send Bank 4 Programs
5	Not Used at Present
6	Send All Banks
7	Send current Sound
8	Send Global
9	Restore Menu

Referring to the table above, each button corresponds to the operation as listed. The action of pressing the button initiates the data transmission.

The data is sent in a standard format which is known as MIDI System Exclusive. This is often known by its shorthand name SYSEX. Before any sending data, check that the device (usually a sequencer) is able to receive this type of data. To send

Bank 3 Programs, for example, press KEY 3. The display will flash **b 3** while data transmission is in progress.

Restoring a single factory preset sound

Select PROGRAM mode and enter the destination location for the single factory preset to be restored to. Select UTILITY mode. Press Key 9, the display will indicate **1 P** (restore single program) Press the + KEY once, the display will start flashing the selected destination program number as a prompt. A second press of the + KEY actually restores the factory preset program.

NOTE: If at any time it is necessary to abandon the restore process, then press the MODE select button.

Utility Mode		Restore Menu	
Key 9	Function	LED Display	
→	1st Press	Restore One Program	1 P
└─┘	2nd	Restore 100 Sounds from Bank 1	B 1
	3th	Restore 100 Sounds from Bank 2	B 2
	4th		

Restoring a Bank of factory preset sounds

Select PROGRAM mode and enter the destination bank for the bank of factory presets to be restored to. (for example, if the sounds in bank 2 are required to be over written, select ANY

sound in bank2) Go to UTILITY mode. Press Key 9 twice, the display will indicate **B 1** (restore bank 1) Each subsequent press will move to the next bank, bank 2. Press the **+ KEY** once, the display will start flashing the selected destination bank number as a prompt.

A second press of the **+ KEY** and the two dots in the display will also flash. The third press actually initiates the restore process. Finally the two dots only will flash and the MODE will change back to PROGRAM mode.

NOTE: If at any time it is necessary to abandon the restore process, then press the MODE select button.

Receiving a single sound from an external device (or other A-Station)

Sounds (using MIDI SYSEX transfers) may be sent to the unit at any time from a sequencer/computer or other A-Station. When a sound is received the display will alternate with - - and the current program number. The received sound will be heard when a note is played. If the sound is to be kept it must be saved in the normal way.

Receiving a bank of sounds from an external device (or other A-Station)

As long as the Memory protect is switch off (see page 6) banks of sounds (using MIDI SYSEX transfers) may be sent to the unit at any time from a sequencer/computer or other A-Station. The bank of sounds will be written into the bank of the currently selected program. For example, if sound 321 is selected, the

incoming bank will be placed in bank 3. To acknowledge reception of incoming data, the display will show the incoming program numbers while data is being received.

Connection Diagram

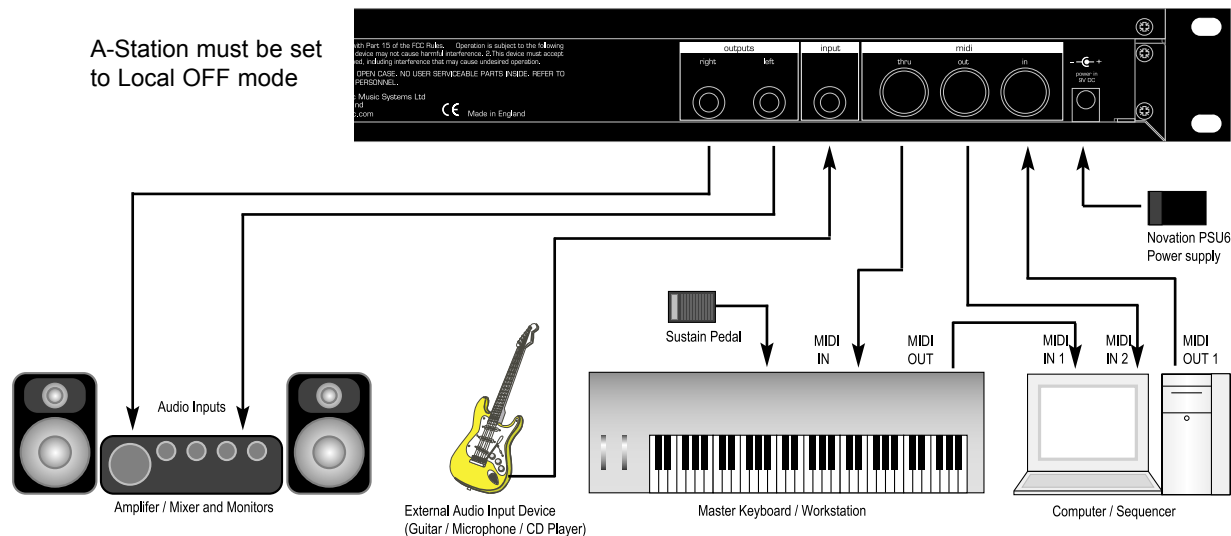

The diagram above illustrates how the A-Station is connected in a typical MIDI recording setup. It utilises all the Input and Output features. This setup allows real-time recording of knob movements into a Computer Software/Sequencer since both the MIDI output of the keyboard and the MIDI output of the A-Station are connected to the Computer Software/Sequencer.

The Computer Software/Sequencer MUST have at least 2 MIDI inputs to allow knob movements to be recorded at the same time as playing the keyboard. If it does not, then a MIDI merge box must be used to merge the MIDI information from the keyboard and the A-Station into a single stream (Consult the manufacturers user guide for the MIDI merge box for correct connec-

tion). If the Master Keyboard is a Workstation (it has a Synthesizer built in) set it to *Local Off* or the equivalent in its MIDI setup. Turn the Computer Software/Sequencers *Soft Thru* (or sometimes called *Echo Back*) to the *On* or *Enabled* position. Select a track in the Computer Software/Sequencer and assign it to the MIDI receive channel of the A-Station.

Play the keyboard and an audio output from the A-Station should be heard through the Headphones/Monitors. Tracks on the Computer Software/Sequencer that are assigned to the MIDI channel(s) of the workstation should also trigger sounds in the workstation.

Volume Control

The Volume may be overridden by MIDI Volume data. If MIDI Volume of 0 has been received by the A-Station, no output will be heard regardless of the position of the volume knob. To reset the volume, either transmit the relevant MIDI Volume level or move the Volume knob - this automatically overrides the MIDI setting.

Responding to MIDI Sustain Pedal On / Off

The A-Station will respond the normal MIDI controller message for Sustain Pedal On / Off. Connect a sustain pedal to the MIDI controller keyboard or workstation that is to be used in the system. It is often necessary to check that the polarity of the pedal is correct for the controller keyboard or workstation that it is to be used with.

Factory Preset Sounds Listings and Examples

Bank 1 - Sounds 100 - 199

No.	Name	No.	Name	No.	Name	No.	Name	No.	Name	No.	Name	No.	Name	No.	Name	No.	Name	No.	Name	No.	Name
100	Bass1	110	Bass2	120	Bass3	130	Bass4	140	Bass5	150	Bass6	160	Bass7	170	Bass8	180	Bass9	190	Bass10		
101	Hard Lead1	111	Hard Lead2	121	Hard Lead3	131	Hard Lead4	141	Hard Lead5	151	Hard Lead6	161	Hard Lead7	171	Hard Lead8	181	Hard Lead9	191	Hard Lead10		
102	Arpeggio1	112	Arpeggio2	122	Arpeggio3	132	Arpeggio4	142	Arpeggio5	152	Arpeggio6	162	Arpeggio7	172	Arpeggio8	182	Arpeggio9	192	Arpeggio10		
103	Dance1	113	Dance2	123	Dance3	133	Dance4	143	Dance5	153	Dance6	163	Dance7	173	Dance8	183	Dance9	193	Dance10		
104	Pad1	114	Pad2	124	Pad3	134	Pad4	144	Pad5	154	Pad6	164	Pad7	174	Pad8	184	Pad9	194	Pad10		
105	Keyboard1	115	Keyboard2	125	Keyboard3	135	Keyboard4	145	Keyboard5	155	Keyboard6	165	Keyboard7	175	Keyboard8	185	Keyboard9	195	Keyboard10		
106	Strings1	116	Strings2	126	Strings3	136	Strings4	146	Strings5	156	Strings6	166	Strings7	176	Strings8	186	Strings9	196	Strings10		
107	Brass1	117	Brass2	127	Brass3	137	Brass4	147	Brass5	157	Brass6	167	Brass7	177	Brass8	187	Brass9	197	Brass10		
108	Organ1	118	Organ2	128	Organ3	138	Organ4	148	Organ5	158	Organ6	168	Organ7	178	Organ8	188	Organ9	198	Organ10		
109	Soft Lead1	119	Soft Lead2	129	Soft Lead3	139	Soft Lead4	149	Soft Lead5	159	Soft Lead6	169	Soft Lead7	179	Soft Lead8	189	Soft Lead9	199	Soft Lead10		

Bank 2 - Sounds 200 - 299

No.	Name	No.	Name	No.	Name	No.	Name	No.	Name	No.	Name	No.	Name	No.	Name	No.	Name	No.	Name	No.	Name
200	Bass11	210	Bass12	220	Bass13	230	Bass14	240	Bass15	250	Bass16	260	Bass17	270	Bass18	280	Bass19	290	Bass20		
201	Hard Lead11	211	Hard Lead12	221	Hard Lead13	231	Hard Lead14	241	Hard Lead15	251	Hard Lead16	261	Hard Lead17	271	Hard Lead18	281	Hard Lead19	291	Hard Lead20		
202	Arpeggio11	212	Arpeggio12	222	Arpeggio13	232	Arpeggio14	242	Arpeggio15	252	Arpeggio16	262	Arpeggio17	272	Arpeggio18	282	Arpeggio19	292	Arpeggio20		
203	Dance11	213	Dance12	223	Dance13	233	Dance14	243	Dance15	253	Dance16	263	Dance17	273	Dance18	283	Dance19	293	Dance20		
204	Pad11	214	Pad12	224	Pad13	234	Pad14	244	Pad15	254	Pad16	264	Pad17	274	Pad18	284	Pad19	294	Pad20		
205	Keyboard11	215	Keyboard12	225	Keyboard13	235	Keyboard14	245	Keyboard15	255	Keyboard16	265	Keyboard17	275	Keyboard18	285	Keyboard19	295	Keyboard20		
206	Trance1	216	Trance2	226	Trance3	236	Trance4	246	Trance5	256	Trance6	266	Trance7	276	Trance8	286	Trance9	296	Trance10		
207	Brass11	217	Brass12	227	Brass13	237	Brass14	247	Brass15	257	Brass16	267	Brass17	277	Brass18	287	Brass19	297	Brass20		
208	Motion1	218	Motion2	228	Motion3	238	Motion4	248	Motion5	258	SFX1	268	SFX2	278	SFX3	288	SFX4	298	SFX5		
209	FM1	219	FM2	229	FM3	239	FM4	249	FM5	259	Vocoder1	269	Vocoder2	279	Vocoder3	289	Ex Aud Trig	299	Ex Aud to FX		

Example initialisation Sounds

A few example sounds have been provided that illustrate how some of the features of the A-Station can be used.

Sound 300 - Double Saw Example 1

The double effect works by making each oscillator produce two waves for each setting - sine, saw and tri. These are normally in phase and appear to be one waveform. The phase difference between each of the two waves for a single oscillator can be independently phase shifted by adjusting the pulse amount control. The phase can be moved from -180 to 180 degrees.

This can be automated by using an LFO to adjust the phase difference between the two waves. When a triangle LFO 2 wave is selected, this will ramp the phase difference of the double waves up and down and

the result is similar to a chorus effect. At moderate to high settings this sounds much like PWM of a square wave. In this sound only oscillator 1 is used. It is set to a sawtooth wave. The PWM position is set centrally and the PWM position from LFO 2 is set to +30. LFO 2 speed is set to 65 with the waveform as a tri wave.

Try varying the speed of LFO 2 and the PWM position from LFO 2 amount for different effects.

Sound 301 - Double Saw Example 2

When a sawtooth wave for LFO 2 is selected and used to modulate the phase difference between the two waves AND the LFO 2 pulse amount is set to maximum, a complete change in phase occurs between the double waves from maximum to minimum (180 to -180 degrees) during the cycle of 1 period of the LFO. This then repeats immediately

from 180 degrees again. This is equivalent to two waves with a constant detune.

In this example only Oscillator 1 is used again. It is set to a sawtooth wave. The PWM position is set centrally and the PWM position from LFO 2 is set to +63. The LFO speed is set to 50 with the LFO 2 waveform as a saw wave.

Try varying the LFO speed to adjust the amount of detune between the double oscillators. Note that settings for the LFO 2 pulse amount that are not maximum or minimum values will produce clicks in the sound because the phase difference will be interrupted.

Sound 302 - Oscillator Sync Example

Oscillator 1 can sync Oscillator 2 so that each time Oscillator 1 completes its cycle it resets the start cycle of Oscillator 2. When listening to only Oscillator 2 this has a very distinctive sound.

Here the Oscillator 2 level is 100% and Oscillator levels for Oscillators 1&3 are both 0%. Oscillator 1 has no envelope modulation whereas Oscillator 2 has a mod env depth of 45. The modulation envelope is set with an attack of 080 and a decay of

100. The sustain and release times for the mod envelope are 000. As the pitch of Oscillator 1 rises and falls this changes the way the Oscillator 2 wave is reset.

Try experimenting with the modulation envelope settings, the mod env depth amount for Oscillator 2 and the Octave / Semitone settings for Oscillators 1&2.

Sound 303 - Ring Mod Example

Here all the Oscillator levels are set to 000. The Ring Mod level is set

to 100%. The modulation envelope has an attack setting of 035 and a decay setting of 105. The mod env amount is set to +50 for Oscillator 2 and -40 for Oscillator 1.

Try experimenting with the modulation envelope settings, the mod env depth amount for Oscillators 1&2 and the octave / semitone settings for Oscillators 1&2.

Sound 304 - Main Output EQ Filter Example.

The additional main output tempo sync'ed enveloped filter.

This is a powerful eq filter which is at the output stage of the signal path of the A-Station. This can boost frequencies as well as attenuate them - compared the low pass filter which can only attenuate. Positive settings of the amount control will boost frequencies above the frequency point and attenuate frequencies below it. Negative settings of the eq amount will attenuate frequencies above the frequency point and boost frequencies below it.

The key point to this feature is the EQ Depth control. This will use a dedicated LFO to move the frequency point of the eq. The eq LFO can be sync'ed to midi clock or to the arpeggiator clock and an eq initial position can also be set just like for the chorus and pan effects.

This example has been set up for use with an external input. It will work particularly well with drum loops etc. Try varying the amp envelope controls and the eq level, depth, rate and frequency controls.

Operating System upgrading via the Internet

Operating System version and Upgrading via the Internet

The A-Station uses a special memory device known as "flash" that contains all of the information that determine how the A-Station functions.

This special device can be re-written by sending it a new set of information using the MIDI input. This set of information is known as an Operating System and has the format of a MIDI file. (Often referred to as O/S) From time to time a new O/S may become available that has new features, or where an existing feature has been improved.

To check the level of current O/S, apply power to the A-Station. The version number will be displayed will briefly. For example 1.0 or 1.1

A free download of the latest O/S is available from the Novation website www.novationmusic.com The O/S is located in the downloads section within the site.

This manual conforms to Operating System version 1.1

Loading in a new operating system (OS).

1) Make a back up of all data stored in the A-Station to a sequencer.

From program mode, press the select button twice so that the utility LED is lit. Connect midi out of the A-Station to midi in of a sequencer and set the sequencer recording. Press button 6 on

the A-Station keypad to initiate the "all banks" data transfer. Stop the sequencer recording when the sequencer midi in indicator shows that all midi activity has finished.

2) Verify the back up.

Change a setting in program 100 which can be remembered. Save the change to the A-Station program 100. Connect the midi out of the sequencer to the midi in of the A-Station. Play the back-up file originally recorded back into the A-Station. If program 100 reverts to the original setting then the back-up should be ok.

3) Play the OS .mid file into the A-Station

Once downloaded from the website, Import the midi file of the operating system into a sequencer. While holding the MODE SELECT down, apply power to the A-Station. 'nu' alternating with 'os' will be displayed. Release the MODE SELECT button and then press the demo button.

The machine will be ready to accept the OS midi file, 'se' alternating with 'nd' will be displayed. Play the midi file out of the sequencer into the A-Station. The LED display will show the percentage of operating system received. Once complete, the LED screen will show 'tn' alternating with 'of' (turn off). The A-Station will need to be turned off and on again for the new OS to take effect.

A-Station technical Specification

Oscillators

Waveform	Square / Saw / Variable Pulse / Tri / Sine / Double Saw / Double Tri / Double Sine
Octave Range	Shift -1 / 0 / +1 / +2
Mod Env Depth	-100% to +100%
LFO1 Depth	-100% to +100%
PWM Source	Mod Env / Manual / LFO2
Ring Mod	1 * 2
FM	2 * 3
2 * 3 FM Level	0 – 100%
2 * 3 FM Mod Level	0 – 100%
FM Env Attack Rate	500uS-20 Seconds
FM Env Decay Rate	1mS-20 Seconds

Mixer

Osc 1 - 2 Level	Off-Osc1-Osc2
Osc 3 Level	0 – 100%
Noise Level	0 – 100%
FM Level	0 – 100%
External Input Level	0 – 100%

Filter

Frequency	5Hz-24kHz
Resonance	0-Self Oscillation (24dB mode)
Mod Env Depth	-100% to +100%
LFO 2 Depth	-100% to +100%
Cut Off	0-100%
Keyboard Tracking	0-100%
Overdrive / Q normalise	0-100%

Amplifier and Mod Envelope

Velocity	-100% to +100%
Attack	250uS-20 Seconds
Decay	1mS-20 Seconds
Sustain	0-100%
Release	1mS – 20 Seconds

LF01 and LFO2

Waveform	Sample & Hold / Tri / Saw / Squ
Speed	0 Hz – 1Khz
Delay Fade In	0 – 5 Seconds
LFO Sync	Internal – MIDI Clock

Arpeggiator

Arpeggiator	Speed / Range / Gate Time / MIDI Clock / Sync / Keysync
-------------	--

Interfacing

MIDI Sockets	In / Out / Thru
Audio Input	Line Level 1 x Mono 1/4" Jack
Audio Outputs	Line Level 2 x Mono 1/4" Jack

Effects

Reverb	Level / Echo Chamber, Small Room Large Room, Small Hall, Large Hall Grand hall / Decay / Wheel Level
Chorus - Phaser	Level / Rate / Type / MIDI Clock Sync / Feedback / Mod Depth / Centre / MIDI clock sync initial Position Wheel Level
Distortion	Drive / Compensation / Wheel Level
Panning	Position / Mod Depth / Speed / MIDI clock Sync Initial Position
Delay	Depth / Time / Feedback / MIDI Clock Sync/ Stereo Width / Ratio / Wheel Level
Vocoder	On –Off / Sibalance Level / Sibalance Type
EQ / Filter	Depth / Freq / Mod Depth / Mod Speed MIDI clock sync / MIDI clock sync Initial position

General

Power	9 Volt D.C. 600 mA
Dimensions	W=483mm H=44mm D=125mm
Weight	1.6 Kg

MIDI Controller List

Midi Controller List

Some controllers adhere to the normal midi-specified use (eg mod-wheel, volume) but most are used arbitrarily and no claim is made of compatibility with other Novation products or other manufacturer's products. This is a common practice among manufacturers.

Whilst an attempt has been made to avoid misuse of "standard" controllers which could cause problems, Novation takes no responsibility for compatibility issues.

Unless noted, controllers are transmitted and received. Unless noted, values have the range 0-127.

#	MIDI-SPECIFIED USE	A-STATION USE
0	bank msb	IGNORED/NOT TRANSMITTED
1	modwheel msb	MODWHEEL (receive only)
2	breath msb	BREATH CONTROL (receive only)
3	undefined msb	ARP PATTERN (0.5 = up, dn, ud1, ud2, order, rand)
4	foot controller msb	---
5	portamento time msb	PORTAMENTO TIME
6	data entry msb	USED FOR NRPN DATA VALUES
7	volume msb	VOLUME
8	balance msb	PREGlide SEMITONES *** -12..+12 (0=preglide disabled)
9	undefined msb	ARP RATE (64..191 bpm)
10	pan msb	PAN POSITION ***
11	expression msb	---
12	effect control 1 msb	NON-SYNC PAN RATE
13	effect control 2 msb	SYNC PAN RATE 0..34 (non-sync, 32Triplet..12bars)
14	undefined msb	VOCODER STEREO WIDTH
15	undefined msb	VOCODER SIBALANCE LEVEL
16	gen. controller 1 msb	MODWHEEL DISTORTION ***
17	gen. controller 2 msb	DISTORTION COMPENSATION
18	gen. controller 3 msb	MODWHEEL DELAY SEND
19	gen. controller 4 msb	NON-SYNC DELAY TIME

*** denotes a signed value where 64 represents zero. Unless noted, this is -64..0..+63 stored as 0..64..127 another example is -12..0..+12 stored as 52..64..76
 --- denotes controller not used

Some controllers use the available 7 data value bits to control more than one parameter. These are noted as "packed parameters" and details are given.

The term "pulse width" is properly applied when squarewave is selected. For other waveforms, read "pulse width" as "double waveform phase offset". Double waveform phase offset is zero when the signed pulse width position parameter is 64 (meaning 0)

#	MIDI-SPECIFIED USE	A-STATION USE
20	undefined msb	SYNC DELAY TIME 0..19 (non-sync, 32Triplet..2Bars)
21	undefined msb	DELAY FEEDBACK
22	undefined msb	DELAY STEREO WIDTH
23	undefined msb	DELAY RATIO
24	undefined msb	MODWHEEL REVERB SEND ***
25	undefined msb	REVERB DECAY
26	undefined msb	MODWHEEL CHORUS SEND ***
27	undefined msb	NON-SYNC CHORUS RATE
28	undefined msb	SYNC CHORUS RATE 0..34 (non-sync, 32Triplet..12bars)
29	undefined msb	CHORUS FEEDBACK ***
30	undefined msb	CHORUS MOD DEPTH
31	undefined msb	CHORUS MOD CENTRE POINT
32	bank lsb	BANK SELECT 1..4
33	modwheel lsb	EQ LEVEL *** (0, 1..63, 64, 65..126, 127 = LP, LPshelf, flat, HPshelf, HP)
34	breath lsb	EQ FREQUENCY
35	undefined lsb	NON-SYNC EQ MOD RATE
36	foot controller lsb	SYNC EQ MOD RATE 0..34 (non-sync, 32Triplet..12bars)
37	portamento time lsb	EQ MOD DEPTH
38	data entry lsb	---

MIDI Controller List

#	MIDI-SPECIFIED USE	A-STATION USE	#	MIDI-SPECIFIED USE	A-STATION USE
39	volume lsb	---	70	sound controller 1	OSC 1,2,3 WAVEFORM / PORTAMENTO MODE (see packed parameter 3)
40	balance lsb	OSC1 SEMITONE *** -12..+12	71	sound controller 2	OSC 1,2,3 OCTAVE / OSC 1>2 SYNC (see packed parameter 4)
41	undefined lsb	OSC1 CENT *** -50..+50	72	sound controller 3	OSC1 LEVEL (to filter)
42	pan lsb	OSC1 BENDWHEEL PITCH AMOUNT ***	73	sound controller 4	OSC2 LEVEL (to filter)
43	expression lsb	OSC1 LFO1 PITCH AMOUNT ***	74	sound controller 5	OSC3 LEVEL (to filter)
44	effect control 1 lsb	OSC1 MOD.ENV PITCH AMOUNT ***	75	sound controller 6	NOISE LEVEL (to filter)
45	effect control 2 lsb	OSC1 PULSE WIDTH POSITION *** (0=50% or in-phase double wave)	76	sound controller 7	OSC 1*2 RINGMOD LEVEL (to filter)
46	undefined lsb	OSC1 LFO2 PULSE WIDTH MOD ***	77	sound controller 8	EXTERNAL INPUT (to filter)
47	undefined lsb	OSC1 MOD.ENV PULSE WIDTH MOD ***	78	sound controller 9	LFO 1,2 WAVEFORM / DELAY MULTI MODE (see packed parameter 5)
48	gen. controller 1 lsb	OSC2 SEMITONE *** -12..+12	79	sound controller 10	LFO 1,2 KEYSYNC / LOCK / PHASE CONTROL (see packed parameter 6)
49	gen. controller 2 lsb	OSC2 CENT *** -50..+50	80	gen. controller 5 lsb	NON-SYNC LFO1 SPEED
50	gen. controller 3 lsb	OSC2 BENDWHEEL PITCH AMOUNT ***	81	gen. controller 6 lsb	SYNC LFO1 SPEED (0=NON-SYNC)
51	gen. controller 4 lsb	OSC2 LFO1 PITCH AMOUNT ***	82	gen. controller 7 lsb	LFO1 DELAY (GRADUAL ONSET TIME)
52	undefined lsb	OSC2 MOD.ENV PITCH AMOUNT ***	83	gen. controller 8 lsb	NON-SYNC LFO2 SPEED
53	undefined lsb	OSC2 PULSE WIDTH POSITION *** (0=50% or in-phase double wave)	84	portamento control	SYNC LFO2 SPEED (0=NON-SYNC)
54	undefined lsb	OSC2 LFO2 PULSE WIDTH MOD ***	85	undefined	LFO2 DELAY (GRADUAL ONSET TIME)
55	undefined lsb	OSC2 MOD.ENV PULSE WIDTH MOD ***	86	undefined	--- (may be used in future software releases)
56	undefined lsb	OSC3 SEMITONE *** -12..+12	87	undefined	ARPEGGIATOR SYNC SETTING 0..15 (32Triplet..1 bar)
57	undefined lsb	OSC3 CENT *** -50..+50	88	undefined	ARPEGGIATOR GATE TIME (100+ GIVES TIED NOTE IN MONO MODE)
58	undefined lsb	OSC3 BENDWHEEL PITCH AMOUNT ***	89	undefined	ARPEGGIATOR CONTROL (see packed parameter 7)
59	undefined lsb	OSC3 LFO1 PITCH AMOUNT ***	90	undefined	
60	undefined lsb	OSC3 MOD.ENV PITCH AMOUNT ***	91	effects 1 depth	REVERB SEND LEVEL
61	undefined lsb	OSC3 PULSE WIDTH POSITION *** (0=50% or in-phase double wave)	92	effects 2 depth	DELAY SEND LEVEL
62	undefined lsb	OSC3 LFO2 PULSE WIDTH MOD ***	93	effects 3 depth	CHORUS SEND LEVEL
63	undefined lsb	OSC3 MOD.ENV PULSE WIDTH MOD ***	94	effects 4 depth	PAN MOD DEPTH
64	sustain pedal	SUSTAIN / MOMENTARY ARP LATCH ON	95	effects 5 depth	VOCODER BALANCE (0=off 64=full vocoder 127=modulator only)
65	portamento on/off	ENVELOPE MODES / OSC WAVEFORM KEYSYNC (see packed parameter 1)	96	data increment	---
66	sostenuto pedal	---	97	data decrement	---
67	soft pedal	UNISON / VOICE TYPE / FILTER TYPE (see packed parameter 2)	98	nrpn lsb	NRPN NUMBER
68	legato footswitch	UNISON DETUNE	99	nrpn msb	IGNORED / NOT TRANSMITTED (for future compatibility, assume value is 0)
69	hold 2	INDIVIDUAL OSCILLATOR RANDOM DETUNE			

MIDI Controller List

#	MIDI-SPECIFIED USE	A-STATION USE
100	rpn lsb	---
101	rpn msb	---
102	undefined	FILTER FREQUENCY LFO2 MOD DEPTH ***
103	undefined	FILTER Q NORMALISE (127=zero filter drive at max resonance)
104	undefined	FILTER OVERDRIVE
105	undefined	FILTER FREQUENCY
106	undefined	FILTER RESONANCE
107	undefined	FILTER FREQUENCY MOD.ENV DEPTH ***
108	undefined	AMPLITUDE ENVELOPE ATTACK
109	undefined	AMPLITUDE ENVELOPE DECAY
110	undefined	AMPLITUDE ENVELOPE SUSTAIN
111	undefined	AMPLITUDE ENVELOPE RELEASE
112	undefined	AMPLITUDE ENVELOPE VELOCITY DEPTH ***
113	undefined	--- (may be used in future software releases)
114	undefined	MOD. ENVELOPE ATTACK
115	undefined	MOD. ENVELOPE DECAY
116	undefined	MOD. ENVELOPE SUSTAIN
117	undefined	MOD. ENVELOPE RELEASE
118	undefined	MOD. ENVELOPE VELOCITY DEPTH ***
119	undefined	VOICE LEVEL TO OUTPUT & EFFECTS
120	all sounds off	ALL NOTES OFF WITH FAST RELEASE (receive only)
121	reset controllers	RESET CONTROLLERS (receive only)
122	local on/off	LOCAL ON/OFF
123	all notes off	ALL NOTES OFF (receive only)
124	omni off	ALL NOTES OFF (receive only)
125	omni on	ALL NOTES OFF (receive only)
126	mono mode setup	ALL NOTES OFF (receive only)
127	poly mode on	ALL NOTES OFF (receive only)

MIDI NRPN LIST

The A-Station uses a few NRPNs as detailed below. Since less than 128 of them are used, only one NRPN msb (bank) is needed. Therefore only the NRPN lsb is transmitted/received and the NRPN msb is ignored and is not transmitted.

For future compatibility, assume that the NRPN msb is 0.

NRPN lsb	A-STATION USE	NRPNs FOR GLOBAL DATA (not part of programs)	
0	FM FIXED LEVEL	32	MIDI RECEIVE CHANNEL 0..15
1	FM ENVELOPE DEPTH ***	33	MIDI TRANSMIT CHANNEL 0..15
2	FM ENVELOPE VELOCITY DEPTH ***	34-37	--- (may be used in future software releases)
3	FM ENVELOPE ATTACK	38	MIDI CLOCK SOURCE (0=internal 1=external)
4	FM ENVELOPE DECAY	39	--- (may be used in future software releases)
5	OSCs 1,2,3 MODWHEEL DIRECT PITCH DEPTH ***	40	MASTER TUNE CENTS ***
6	OSCs 1,2,3 AFTERTOUCH DIRECT PITCH DEPTH ***	41	VELOCITY CURVE (0=soft 1=hard)
7	OSCs 1,2,3 BREATH DIRECT PITCH DEPTH ***	42	EXTERNAL INPUT RANGE (0=line 1=mic)
8	OSCs 1,2,3 MODWHEEL LFO1 PITCH DEPTH ***	43	EXTERNAL INPUT TRIM (-10..+20 dB)
9	OSCs 1,2,3 AFTERTOUCH LFO1 PITCH DEPTH ***	44	EXTERNAL INPUT TRIGGER SENSITIVITY (0 is most sensitive)
10	OSCs 1,2,3 BREATH LFO1 PITCH DEPTH ***	45	GLOBAL SYNC TYPE (0,1,2 = note when all notes off, first note after prog change, midi song start)
11	FILTER KEYBOARD TRACKING (0=NONE, 127=PRECISE PITCH TRACK)	46	PARAMETER MOMENTARY DISPLAY TIME (off.200..1200mS)
12	FILTER MODWHEEL DIRECT FREQUENCY DEPTH ***	47	MENU INITIAL PAGE MODE (0=first 1=last used)
13	FILTER AFTERTOUCH DIRECT FREQUENCY DEPTH ***	48-127	--- (may be used in future software releases)
14	FILTER BREATH DIRECT FREQUENCY DEPTH ***		
15	FILTER MODWHEEL LFO2 FREQUENCY DEPTH ***		
16	FILTER AFTERTOUCH LFO2 FREQUENCY DEPTH ***		
17	FILTER BREATH LFO2 FREQUENCY DEPTH ***		
18	AMPLITUDE MODWHEEL DIRECT DEPTH ***		
19	AMPLITUDE AFTERTOUCH DIRECT DEPTH ***		
20	AMPLITUDE BREATH DIRECT DEPTH ***		
21	EFFECTS TYPE CONTROL (see packed parameter 8)		
22	EFFECTS GLOBAL SYNC CONTROL (see packed parameter 9)		
23	EFFECTS, VOCODER & EXTERNAL AUDIO CONTROL (see packed parameter 10)		
24-31	RESERVED --- (may be used in future software releases)		

Packed Controller / NRPN Parameter Details

Packed Controller / NRPN Parameter Details -

1	ENVELOPES SINGLE-MULTI / OSC WAVEFORM KEYSYNC bit 0 amp env trigger 0=single 1=multi bit 1 mod env trigger 0=single 1=multi bit 2 fm env trigger 0=single 1=multi bits 3-6 4-bit wave keysync phase 0=free-running 1..15 = 0..336 degrees in 24 degree steps
2	UNISON / POLY MODE / FILTER TYPE bits 0-2 3-bit unison count 0=off 1..7=2..8 voices bits 3-4 2-bit voice polyphony mode 0=mono 1=mono autoglide 2=poly 3=poly with "same note voice stealing" bit 5 filter type 0=12dB 1=24dB per octave
3	OSC 1/2/3 WAVEFORM / PORTAMENTO MODE bits 0-1 2-bit osc1 waveform sine, tri, saw, square (pulse) bits 2-3 2-bit osc2 waveform sine, tri, saw, square (pulse) bits 4-5 2-bit osc3 waveform sine, tri, saw, square (pulse) bit 6 portamento mode 0=exponential 1=linear
4	OSC 1,2,3 OCTAVE / OSC 1>2 SYNC bits 0-1 2-bit osc1 octave -1,0,1,2 bits 2-3 2-bit osc2 octave -1,0,1,2 bits 4-5 2-bit osc3 octave -1,0,1,2 bit 6 osc1>2 sync 1=on
5	LFO 1,2 WAVEFORM / DELAY MULTI MODE bit 0 lfo1 delay multi 1=on bit 1 lfo2 delay multi 1=on bits 2-3 2-bit lfo1 waveform tri, saw, square, s/h bits 4-5 2-bit lfo2 waveform tri, saw, square, s/h
6	LFO 1,2 KEYSYNC / LOCK / PHASE CONTROL bit 0 lfo1 keysync phase shift bit 1 lfo1 keysync 1=on bit 2 lfo1 lock 0=independent per voice 1=all voices same phase bit 3 lfo2 keysync phase shift bit 4 lfo2 keysync 1=on bit 5 lfo2 lock 0=independent per voice 1=all voices same phase note that when lock is on, keysync becomes global sync (ie note when all notes off, first note after prog change, song start message)

Refer to the lists of MIDI Controllers and NRPNs on Pages A-6 thru A-8

7	ARPEGGIATOR CONTROL bits 0-1 2-bit number of octaves 1,2,3,4 bit 2 arpeggiator off/on 1=on bit 3 arpeggiator keysync control 1=on bit 4 arpeggiator latch control 1=on bits 5-6 2 bit Arp Note Destination Control where 00 = Internal 01 = External 10 = Internal + External 11 = External + Played
8	EFFECTS TYPE CONTROL bits 0-2 3-bit reverb type Ec Sr Sh Lr Lh gh (values 6,7 not used) bit 3 chorus/phaser control 0=chorus 1=phaser
9	EFFECTS GLOBAL SYNC CONTROL bits 0-1 2-bit chorus global sync off,left,centre,right bits 2-3 2-bit pan global sync off,left,centre,right bits 4-5 2-bit eq frequency global sync off,low,mid,high
10	EFFECTS, VOCODER & EXTERNAL AUDIO CONTROL bit 3 vocoder sibilance type 0=hi-pass 1=noise bit 5 external audio trigger control 1=enabled bit 6 external audio to fx control 1=enabled
11	OSC SELECT, NOISE RING EXTERNAL SELECT PWM SOURCE SELECT LFO SELECT bits 0-1 Osc Select 0=1 1=2 2=3 bits 2-3 0=Noise 1=Ring 1,2 2=External Input bits 4-5 0=PW Position 1=LFO2 Mod 2=Mod Env Modbits 4-5 bit 6 LFO Select 0= LFO1 1=LFO2

SYSEX MESSAGES

COMMON FORMAT

F0h	SYSEX START	
00h	NOVATION ID 1	
20h	NOVATION ID 2	
29h	NOVATION ID 3	
01h	DEVICE TYPE	(1 = Synth)
40h	A-STATION	
SyCh	SYSEX CHANNEL	Always transmitted as 7Fh for receive can be 7Fh or the receive channel)
M	MESSAGE TYPE	(Current Sound, Program, Global data etc. See following Messages)
C	CONTROL BYTE	(Used to control destination bank when program dumps are received)
Vv	SOFTWARE VERSION	(Bits:- 0VVVVvvv eg 00001000 = version 1.0)
Vi	VERSION INCREMENT 0..99	(Hold keypad "3" during power-up to view the full version eg 1.0.06)
B	PROGRAM BANK 1..4	(Zero if not appropriate)
P	PROGRAM NUMBER 0..99	(Zero if not appropriate)
	DATA BLOCK	(data block(s))
	.	(included if)
	.	(appropriate to)
	DATA BLOCK	(message type)
F7h	END OF EXCLUSIVE	

Note: Currently, the software version and version increment bytes are transmitted for information only and are ignored when a message is received. Future software releases may, on receipt of some message types from an earlier version, alter the data before storing it. This will only apply to messages which contain data blocks. To ensure future compatibility, librarian programs should always maintain a match between the Vv and Vi byte values and the data block content.

SYSEX DATA DUMP MESSAGES

CURRENT SOUND DUMP

When received, this will be the active sound. It is not stored in flash. The source bank and program number are irrelevant and the control byte is ignored.

F0h	SYSEX START	
00h	NOVATION ID 1	
20h	NOVATION ID 2	
29h	NOVATION ID 3	
01h	DEVICE TYPE	
40h	A-STATION	
SyCh	SYSEX CHANNEL	Transmitted 7Fh : Received 7Fh or current receive channel
00h	MESSAGE TYPE	Current sound dump
00h	CONTROL BYTE	Transmitted 0 : Received don't care
Vv	SOFTWARE VERSION	
Vi	VERSION INCREMENT	
00h	PROGRAM BANK	Transmitted 0 : Received don't care
00h	PROGRAM NUMBER	Transmitted 0 : Received don't care
	PROGRAM BLOCK 128 bytes	See PROGRAM DATA BLOCK On page A-13 for format
F7h	END OF EXCLUSIVE	

MIDI System Exclusive

PROGRAM DUMP

When received, the sound is stored in flash at the supplied bank and program number if C = 1.

If C = 0, the bank used is the currently selected bank.

F0h	SYSEX START	
00h	NOVATION ID 1	
20h	NOVATION ID 2	
29h	NOVATION ID 3	
01h	DEVICE TYPE	
40h	A-STATION	
SyCh	SYSEX CHANNEL	Transmitted 7Fh : received 7Fh or current receive channel
01h	MESSAGE TYPE	Program dump
C	CONTROL BYTE	0 or 1 destination bank control
Vv	SOFTWARE VERSION	
Vi	VERSION INCREMENT	
B	PROGRAM BANK	Transmitted 1-4 : received don't care if C=0
P	PROGRAM NUMBER	0-99
	PROGRAM BLOCK 128 bytes.	See PROGRAM DATA BLOCK On page A-13 for format
F7h	END OF EXCLUSIVE	

PROGRAM PAIR DUMP

Conveys two adjacent programs where the first is even-numbered eg 98+99. Note that P must be even.

When received, the two sounds are stored in flash at the supplied bank and program number if C = 1.

If C = 0, the bank used is the currently selected bank.

F0h	SYSEX START	
00h	NOVATION ID 1	
20h	NOVATION ID 2	
29h	NOVATION ID 3	
01h	DEVICE TYPE	
40h	A-STATION	
SyCh	SYSEX CHANNEL	Transmitted 7Fh : Received 7Fh or current receive channel
02h	MESSAGE TYPE	Program pair dump
C	CONTROL BYTE	0 or 1 destination bank control
Vv	SOFTWARE VERSION	
Vi	VERSION INCREMENT	
B	PROGRAM BANK	Transmitted 1-4 : received don't care if C=0
P	PROGRAM NUMBER	0,2,4...98
	PROGRAM BLOCK 128 bytes.	Even numbered program - See PROGRAM DATA BLOCK On page A-13 for format
	PROGRAM BLOCK 128 bytes.	Odd numbered program - See PROGRAM DATA BLOCK On page A-13 for format
F7h	END OF EXCLUSIVE	

Note: the purpose of the program pair dump is for internal efficiency in flash memory storage. This message type is used for all bank dumps invoked from the front panel. A full bank dump consists of 50 program pair dumps.

When a single bank dump is transmitted, C=0 such that the receiving A-Station current bank will be the destination.

When an all banks dump is transmitted, C=1 such that the receiving Station will store the programs in the bank given in the B byte.

When a third party librarian or device receives either a program dump or program pair dump, it can ignore the C value but when it transmits one of these dumps to a A-Station, it must be aware of the effect of the C value.

GLOBAL DATA DUMP

When received, the flash global data block is overwritten.

The source bank and program number are irrelevant and the control byte is ignored.

F0h	SYSEX START	
00h	NOVATION ID 1	
20h	NOVATION ID 2	
29h	NOVATION ID 3	
01h	DEVICE TYPE	
40h	A-STATION	
SyCh	SYSEX CHANNEL	Transmitted 7Fh : received 7Fh or current receive channel
03h	MESSAGE TYPE	Global data dump
00h	CONTROL BYTE	Transmitted 0 : received don't care
Vv	SOFTWARE VERSION	
Vi	VERSION INCREMENT	
00h	(PROGRAM BANK)	Transmitted 0 : Received don't care
00h	(PROGRAM NUMBER)	Transmitted 0 : Received don't care

GLOBAL DATA BLOCK 256 bytes. See GLOBAL DATA BLOCK On page **A-13** for format

F7h END OF EXCLUSIVE

MIDI System Exclusive - Receive Requests

SYSEX REQUEST MESSAGES (receive only)

CURRENT SOUND DUMP REQUEST

F0h	SYSEX START	
00h	NOVATION ID 1	
20h	NOVATION ID 2	
29h	NOVATION ID 3	
01h	DEVICE TYPE	
40h	A-STATION	
SyCh	SYSEX CHANNEL	7Fh or current receive channel
40h	MESSAGE TYPE	Current sound dump request
00h	CONTROL BYTE	Don't care
Vv	SOFTWARE VERSION	Ddon't care
Vi	VERSION INCREMENT	Ddon't care
00h	PROGRAM BANK	Don't care
00h	PROGRAM NUMBER	Don't care
F7h	END OF EXCLUSIVE	

PROGRAM DUMP REQUEST

F0h	SYSEX START	
00h	NOVATION ID 1	
20h	NOVATION ID 2	
29h	NOVATION ID 3	
01h	DEVICE TYPE	
40h	A-STATION	
SyCh	SYSEX CHANNEL	7Fh or current receive channel
41h	MESSAGE TYPE	Program dump request
C	CONTROL BYTE	Reply will copy this value for C
Vv	SOFTWARE VERSION	Don't care
Vi	VERSION INCREMENT	Don't care
B	PROGRAM BANK	1-4 : don't care if C=0
P	PROGRAM NUMBER	0-99
F7h	END OF EXCLUSIVE	

PROGRAM PAIR DUMP REQUEST

F0h	SYSEX START	
00h	NOVATION ID 1	
20h	NOVATION ID 2	
29h	NOVATION ID 3	
01h	DEVICE TYPE	
40h	A-STATION	
SyCh	SYSEX CHANNEL	7Fh or current receive channel
42h	MESSAGE TYPE	Program pair dump request
C	CONTROL BYTE	Reply will copy this value for C
Vv	SOFTWARE VERSION	Don't care
Vi	VERSION INCREMENT	Don't care
B	PROGRAM BANK	1-4 : Don't care if C=0
P	PROGRAM NUMBER	0,2,4...98
F7h	END OF EXCLUSIVE	

GLOBAL DATA DUMP REQUEST

F0h	SYSEX START	
00h	NOVATION ID 1	
20h	NOVATION ID 2	
29h	NOVATION ID 3	
01h	DEVICE TYPE	
40h	A-STATION	
SyCh	SYSEX CHANNEL	7Fh or current receive channel
43h	MESSAGE TYPE	Global data dump request
00h	CONTROL BYTE	Don't care
Vv	SOFTWARE VERSION	Don't care
Vi	VERSION INCREMENT	Ddon't care
00h	(PROGRAM BANK)	Don't care
00h	(PROGRAM NUMBER)	Don't care
F7h	END OF EXCLUSIVE	

MIDI System Exclusive

GLOBAL DATA BLOCK (256 bytes)

Byte	Parameter	Byte	Parameter
0	POWER-UP PROGRAM BANK 1..4	5	OSC 1,2,3 WAVEFORM / PORTAMENTO MODE (see packed parameter 3)
1	POWER-UP PROGRAM NUMBER 0..99	6	OSC 1,2,3 OCTAVE / OSC 1>2 SYNC (see packed parameter 4)
2	MEMORY PROTECT (0=protected 1=not protected)		
3	MIDI LOCAL CONTROL (0=off 127=on)	7	OSC1 SEMITONE *** -12..+12
4	MIDI RECEIVE CHANNEL 0..15	8	OSC1 CENT *** -50..+50
5	MIDI TRANSMIT CHANNEL 0..15	9	OSC1 BENDWHEEL PITCH AMOUNT ***
6-9	--- (may be used in future software releases)	10	OSC1 LFO1 PITCH AMOUNT ***
10	MIDI CLOCK SOURCE (0=internal 1=external)	11	OSC1 MOD.ENV PITCH AMOUNT ***
11	--- (may be used in future software releases)	12	OSC1 PULSE WIDTH POSITION *** (0=50% or in-phase double wave)
12	MASTER TUNE CENTS ***	13	OSC1 LFO2 PULSE WIDTH MOD ***
13	VELOCITY CURVE (0=soft 1=hard)	14	OSC1 MOD.ENV PULSE WIDTH MOD ***
14	EXTERNAL INPUT RANGE (0=line 1=mic)		
15	EXTERNAL INPUT TRIM (-10..+20 dB)	15	OSC2 SEMITONE *** -12..+12
16	EXTERNAL INPUT TRIGGER SENSITIVITY (0 is most sensitive)	16	OSC2 CENT *** -50..+50
17	GLOBAL SYNC TYPE (0,1,2 = note when all notes off, first note after prog change, midi song start)	17	OSC2 BENDWHEEL PITCH AMOUNT ***
18	PARAMETER MOMENTARY DISPLAY TIME (off.200..1200ms)	18	OSC2 LFO1 PITCH AMOUNT ***
19	MENU INITIAL PAGE MODE (0=first 1=last used)	19	OSC2 MOD.ENV PITCH AMOUNT ***
20-255	--- (may be used in future software releases) Zeros are transmitted. Use zeros for future compatibility	20	OSC2 PULSE WIDTH POSITION *** (0=50% or in-phase double wave)
		21	OSC2 LFO2 PULSE WIDTH MOD ***
		22	OSC2 MOD.ENV PULSE WIDTH MOD ***

DATA BLOCKS USED IN SYSEX MESSAGES

See Midi Controller Map for further details of parameters and meaning of ***.

PROGRAM DATA BLOCK (128 bytes)

Byte	Parameter	Byte	Parameter
0	UNISON / VOICE TYPE / FILTER TYPE (see packed parameter 2)	23	OSC3 SEMITONE *** -12..+12
1	UNISON DETUNE	24	OSC3 CENT *** -50..+50
2	INDIVIDUAL OSCILLATOR RANDOM DETUNE	25	OSC3 BENDWHEEL PITCH AMOUNT ***
3	PORTAMENTO TIME	26	OSC3 LFO1 PITCH AMOUNT ***
4	PREGlide SEMITONES *** -12..+12 (0=preglide disabled)	27	OSC3 MOD.ENV PITCH AMOUNT ***
		28	OSC3 PULSE WIDTH POSITION *** (0=50% or in-phase double wave)
		29	OSC3 LFO2 PULSE WIDTH MOD ***
		30	OSC3 MOD.ENV PULSE WIDTH MOD ***
		31	OSCs 1,2,3 MODWHEEL DIRECT PITCH DEPTH ***
		32	OSCs 1,2,3 AFTERTOUCH DIRECT PITCH DEPTH ***
		33	OSCs 1,2,3 BREATH DIRECT PITCH DEPTH ***
		34	OSCs 1,2,3 MODWHEEL LFO1 PITCH DEPTH ***
		35	OSCs 1,2,3 AFTERTOUCH LFO1 PITCH DEPTH ***
		36	OSCs 1,2,3 BREATH LFO1 PITCH DEPTH ***

PROGRAM DATA BLOCK (continued)

Byte	Parameter	Byte	Parameter
37	OSC1 LEVEL (to filter)	74	LFO1 DELAY (GRADUAL ONSET TIME)
38	OSC2 LEVEL (to filter)	75	NON-SYNC LFO2 SPEED
39	OSC3 LEVEL (to filter)	76	SYNC LFO2 SPEED (0=NON-SYNC)
40	NOISE LEVEL (to filter)	77	LFO2 DELAY (GRADUAL ONSET TIME)
41	OSC 1*2 RINGMOD LEVEL (to filter)	78	LFO 1,2 WAVEFORM / DELAY MULTI MODE (see packed parameter 5)
42	EXTERNAL INPUT (to filter)	79	LFO 1,2 KEYSYNC / LOCK / PHASE CONTROL (see packed parameter 6)
43	FILTER OVERDRIVE	80	ENVELOPE MODES / OSC WAVEFORM KEYSYNC (see packed parameter 1)
44	FILTER RESONANCE	81	AMPLITUDE MODWHEEL DIRECT DEPTH ***
45	FILTER Q NORMALISE (127=zero filter drive at max resonance)	82	AMPLITUDE AFTERTOUCH DIRECT DEPTH ***
46	FILTER FREQUENCY	83	AMPLITUDE BREATH DIRECT DEPTH ***
47	FILTER KEYBOARD TRACKING (0=NONE, 127=PRECISE PITCH TRACK)	84	ARPEGGIATOR/GENERAL SYNC RATE (64..191 bpm)
48	FILTER MODWHEEL DIRECT FREQUENCY DEPTH ***	85	ARPEGGIATOR SYNC SETTING 0..15 (32Triplet..1 bar)
49	FILTER AFTERTOUCH DIRECT FREQUENCY DEPTH ***	86	ARPEGGIATOR GATE TIME (100+ GIVES TIED NOTE IN MONO MODE)
50	FILTER BREATH DIRECT FREQUENCY DEPTH ***	87	ARP PATTERN (0.5 = up, down, ud1, ud2, order, random)
51	FILTER FREQUENCY LFO2 MOD DEPTH ***	88	ARPEGGIATOR CONTROL (see packed parameter 7)
52	FILTER FREQUENCY MOD.ENV DEPTH ***	89	VOCODER BALANCE (0=off 64=full vocoder 127=modulator only)
53	FILTER MODWHEEL LFO2 FREQUENCY DEPTH ***	90	VOCODER STEREO WIDTH
54	FILTER AFTERTOUCH LFO2 FREQUENCY DEPTH ***	91	VOCODER SIBILANCE LEVEL
55	FILTER BREATH LFO2 FREQUENCY DEPTH ***	92	EQ LEVEL *** (0, 1..63, 64, 65..126, 127 = LP, LP shelf, flat, HP shelf, HP)
56	FM FIXED LEVEL	93	EQ FREQUENCY
57	FM ENVELOPE DEPTH ***	94	NON-SYNC EQ MOD RATE
58	FM ENVELOPE VELOCITY DEPTH ***	95	SYNC EQ MOD RATE 0..34 (non-sync, 32Triplet..12bars)
59	FM ENVELOPE ATTACK	96	EQ MOD DEPTH
60	FM ENVELOPE DECAY	97	DISTORTION LEVEL
61	AMPLITUDE ENVELOPE VELOCITY DEPTH ***	98	MODWHEEL DISTORTION ***
62	AMPLITUDE ENVELOPE ATTACK	99	DISTORTION COMPENSATION
63	AMPLITUDE ENVELOPE DECAY	92	EQ LEVEL *** (0, 1..63, 64, 65..126, 127 = LP, LP shelf, flat, HP shelf, HP)
64	AMPLITUDE ENVELOPE SUSTAIN	93	EQ FREQUENCY
65	AMPLITUDE ENVELOPE RELEASE	94	NON-SYNC EQ MOD RATE
66	MOD. ENVELOPE VELOCITY DEPTH ***	95	SYNC EQ MOD RATE 0..34 (non-sync, 32Triplet..12bars)
67	MOD. ENVELOPE ATTACK	96	EQ MOD DEPTH
68	MOD. ENVELOPE DECAY	97	DISTORTION LEVEL
69	MOD. ENVELOPE SUSTAIN	98	MODWHEEL DISTORTION ***
70	MOD. ENVELOPE RELEASE	99	DISTORTION COMPENSATION
71	--- (may be used in future software releases)		
72	NON-SYNC LFO1 SPEED		
73	SYNC LFO1 SPEED (0=NON-SYNC)		

MIDI System Exclusive

PROGRAM DATA BLOCK (continued)

Byte	Parameter
100	DELAY SEND LEVEL
101	MODWHEEL DELAY SEND
102	NON-SYNC DELAY TIME
103	SYNC DELAY TIME 0..19 (non-sync, 32Triplet..2bars)
104	DELAY FEEDBACK
105	DELAY STEREO WIDTH
106	DELAY RATIO
107	REVERB SEND LEVEL
108	MODWHEEL REVERB SEND ***
109	REVERB DECAY
110	CHORUS SEND LEVEL
111	MODWHEEL CHORUS SEND ***
112	NON-SYNC CHORUS RATE
113	SYNC CHORUS RATE 0..34 (non-sync, 32Triplet..12bars)
114	CHORUS FEEDBACK ***
115	CHORUS MOD DEPTH
116	CHORUS MOD CENTRE POINT
117	PAN POSITION ***
118	NON-SYNC PAN RATE
119	SYNC PAN RATE 0..34 (non-sync, 32Triplet..12bars)
120	PAN MOD DEPTH
121	EFFECTS TYPE CONTROL (see packed parameter 8)
122	EFFECTS GLOBAL SYNC CONTROL (see packed parameter 9)
123	EFFECTS, VOCODER & EXTERNAL AUDIO CONTROL (see packed parameter 10)
124	--- (may be used in future software releases)
125	VOICE LEVEL TO OUTPUT & EFFECTS
126	--- (may be used in future software releases)
127	OSC, SOURCE, PW, LFO SELECTORS (see packed parameter 11)

Function		Transmitted	Recognised	Remarks
Basic Channel	Default	1 - 16	1 - 16	Memorised
	Changed	1 - 16	1 - 16	
Mode	Default Messages Altered	X *****	MODE 3 - 4 X	Memorised in Program
Note Number	TRUE Voice	0 - 127 *****	0 - 127	
Velocity	Note On Note Off	O V = 1 - 127 X	O V = 1 - 127 X	
Aftertouch	Keys	X	X	
	Channel	X	O	
Pitch Bend		O	O	
Control Change		1, 3, 5 - 10 12 - 37,40 - 65 67 - 85, 87 - 89 91 - 95, 98, 100 102 - 112, 114 - 119	1, 3, 5 - 10 12 - 37,40 - 65 67 - 85, 87 - 89 91 - 95, 98, 100 102 - 112, 114 - 119	See Controller & NRPN tables in Appendix for full details
Program Change	TRUE	0 - 99 *****	0 - 99	
System Exclusive		O	O	Programs & Global Data Dumps, OS Upgrades
System Real - Time		X	O	Start Song, Clock
System Common		X	X	
Aux Messages	Local On All Notes Off Active Sense Reset Control All Sound Off	O O X X X	O O X X X	

Mode 1 : OMNI ON, POLY
Mode 3 : OMNI OFF, POLY

Mode 2 : OMNI ON, MONO
Mode 4 : OMNI OFF, MONO

O : Yes
X : No

Menus

	Global Mode	Program mode - Function switch set to SHIFT				
KEY PRESS	KEY 0	KEY 1	KEY 2	KEY 3	KEY 4	KEY 5
	Global	Delay	Reverb	Chorus	Distortion.. Panning.. EQ...	Vocoder
1st	Tuning - Cents t u 50. - 50	Delay Level d L 0 - 27.	Reverb Level r L 0 - 27.	Chorus Level c L 0 - 27.	Distortion Drive d d 0 - 27.	Vocoder Balance u b 0 - 27.
2nd	Local L o of - on	Delay Time d t 0 - 27.	Reverb Type r t S r - L h	Chorus Type c t C h - P h	Distortion Compensation d c 0 - 27.	Vocoder Sibalance Level u L 0 - 27.
3rd	Midi Clock Source c S i - e	Delay Feedback d F 64. - 63	Reverb Decay r d 0 - 27.	Chorus Rate c r 0 - 27.	Distortion Wheel Amt d u 0 - 27.	Vocoder SibalanceType u t h P - n o
4th	Midi Clock Inspector c i - - 96	Delay Sync d y oF - 2b	Reverb - Wheel Level r u 0 - 27.	Chorus Sync c y oF - 12	Pan Position p p 64. - 63	Vocoder Stereo Width u S 0 - 27.
5th	Clock Sync Type S t P C - S S	Delay Stereo Width d S 0 - 27.		Chorus Mod Depth c d 0 - 27.	Pan Depth P d 0 - 27.	
6th	Pot Display Persistence P P 00 - 99	Delay Ratio d r 11 - 14		Chorus Centre c c 64. - 63	Pan Rate p r 0 - 27.	
7th	Velocity Curve u C S t - H d	Delay Wheel Level d u 0 - 27.		Chorus Feedback c F 64. - 63	Pan Sync p y oF - 12	
8th	Menu Initial Display i d oF - on			Chorus LFO Initial Pos'n c l oF - R t	Panning's LFO's Init Position P l oF - R t	
9th	Input Sensitivity i S Lo - H I			Chorus Wheel Level c u 0 - 27.	EQ Amount E A 64. - 63	
10th	Input Trim i t 10. - 20				EQ Frequency E F 0 - 27.	
11th	Input Trig Sensitivity i L 00 - 99				EQ Depth E d 0 - 27.	
12th					EQ Rate E r 0 - 27.	
13th					EQ Sync E y oF - 12	
14th					EQ LFO Initial Position E k oF - H I	

Program mode - Function switch set to SHIFT

KEY 6	KEY 7	KEY 8	KEY 9	KEY 0
Arpeggiator	Oscillators	Wheels	Aftertouch.. Breath..	Velocity.. Triggering.. Synchronisation
Arp Mode A c o F - o b	Unison u n o F - 8	Osc 1 Pitch Bend Amt b 1 12. - 12	Aftertouch to Osc 1,2,3 Absolute Pitch A P 64. - 63	Velocity to Amp Env Level u A 64. - 63
Arp Speed A r 64 - 91.	Unison Detune u d 0 - 27.	Osc 2 Pitch Bend Amt b 2 12. - 12	Aftertouch to Osc 1,2,3 LFO 1 Mod Amt A L 64. - 63	Velocity to Mod Env Level u E 64. - 63
Arp Oct Range A o 1 - 4	VCO Drift d r 0 - 27.	Osc 3 Pitch Bend Amt b 3 12. - 12	Aftertouch to Filter Absolute Freq A F 64. - 63	Velocity to FM Env Level u F 64. - 63
Arp Gate Time A g 0 - 27.	Osc 1,2,3 Preglide P g 12. - 12	Osc 1,2,3 Absolute Pitch Amt P A 64. - 63	Aftertouch to Filter LFO 2 Mod Amt A n 64. - 63	Voice Mode n n n A - P 2
Arp Pattern A P u P - r d	Oscillator Start Phase o P o F - 14	Osc 1,2,3 Pitch Mod (LFO1) Amt P L 64. - 63	Aftertouch to Amplifier Level A A 64. - 63	Porta Type P t E L
Arp Sync A y oF - 2b	Osc 2 - 3 FM Manual Level F L 0 - 27.	Filter Cut Off Absolute Freq Amt F A 64. - 63	Breath to Osc 1,2,3 Absolute Pitch b P 64. - 63	Envelopes Triggering Type E t n E - b E
	Osc 2 - 3 FM Env Amt F E 64. - 63	Filter Cut Off Freq Mod (LFO2) Amt F L 64. - 63	Breath to Osc 1,2,3 LFO 1 Mod Amt b L 64. - 63	Enable External Triggering E E o F - E d
	FM Env Attack F A 0 - 27.	Amplifier Level A L 64. - 63	Breath to Filter Absolute Freq b F 64. - 63	LFO's Delay Triggering L d nL - b L
	FM Env Decay F d 0 - 27.		Breath to Filter LFO 2 Mod Amt b n 64. - 63	LFO 1 Lock and Sync Control L 1 -- k O
			Breath to Amplifier Level b A 64. - 63	LFO 2 Lock and Sync Control L 2 -- k O
				LFO 1 Midi Clock Sync y 1 o F - 12
				LFO 2 Midi Clock Sync y 2 o F - 12

FCC Information (U.S.A.)

1. **IMPORTANT NOTICE: DO NOT MODIFY THIS UNIT!** This product, when installed as indicated in the instructions contained in this Manual, meets FCC requirements. Modifications not expressly approved by Novation may void your authority, granted by the FCC, to use the product.
2. **IMPORTANT:** When connecting this product to accessories and/or another product use only high quality shielded cables. Cable/s supplied with this product **MUST** be used. Follow all installation instructions. Failure to follow instructions could void your FCC authorization to use this product in the USA.
- 3 **NOTE:** This product has been tested and found to comply with the requirements listed in FCC Regulations, Part 15 for Class "B" digital devices. Compliance with these requirements provides a reasonable level of assurance that your use of this product in residential environment will not result in harmful interference with other electronic devices. This equipment generates/uses radio frequencies and, if not installed and used according to the instructions found in the users manual, may cause interference harmful to the operation of other electronic devices. Compliance with FCC regulations does not guarantee that interference will not occur in all installations. If this product is found to be the source of interference, which can be determined by turning the unit "OFF" and "ON", please try to eliminate the problem by using one of the following measures:

Relocate either this product or the device that is being affected by the interference.

Utilize power outlets that are on different branch (Circuit breaker or fuse) circuits or install AC line filter/s.

In the case of radio or TV interference, relocate/re orient the antenna. If the antenna lead-in is 300 ohm ribbon lead, change the lead-in to co-axial type cable.

If these corrective measures do not produce satisfactory results, please contact the local retailer authorized to distribute this type of product.

The statements above apply **ONLY** to products distributed in the USA.

CANADA

The digital section of this apparatus does not exceed the "Class B" limits for radio noise emissions from digital apparatus set out in the radio interference regulation of the Canadian Department of Communications.

Le present appareil numerique n'emet pas de bruits radioelectriques depassant les limites applicables aux appareils numeriques de la "Classe B" prescrites dans le reglement sur le brouillage radioelectrique edicte par le Ministere Des Communications du Canada.

This only applies to products distributed in Canada.

Ceci ne s'applique qu'aux produits distribues dans Canada.

Other Standards (Rest of World)

This product complies with the radio frequency interference requirements of the Council Directive 89/336/EC.

Dette apparat overholder det gældende EF-direktiv vedrørende radiofrekvensinterferens. Cet appareil est conforme aux prescriptions de la directive communautaire 89/336/EC.

Diese Geräte entsprechen der EG-Richtlinie 89/336/EC.

Specifications subject to change:

The information contained in this manual is believed to be correct at the time of going to press. However, Novation reserves the right to change or modify the specification without notice or obligation to update existing units.

Copyright 2001

Novation Electronic Music Systems Ltd.

Part No: MAN-AST-UK
Vers. 1.1



novation
in music, anything is possible.

Novation EMS Limited
Platinum House 32 Clivmont Road Maidenhead Berkshire England SL6 7BZ
Phone +44 1 628 678520 Fax +44 1 628 671122 E-mail sales@novationmusic.com

Novation USA Limited
Int. Toll-free Tel: 011 - 800 - NOVATION (6682-8466) E-mail salesusa@novationmusic.com

Specification subject to change without prior notice.

www.novationmusic.com