

SIRIN CHEAT SHEET



FREE EDITOR/LIBRARIAN

Access and automate every parameter on and under the hood of your Sirin right from your DAW. Get the free Editor/Librarian software when you register your Sirin at [Moogmusic.com/register](https://www.moogmusic.com/register)

STORE AND CHANGE PRESETS

Up to 128 presets can be saved and loaded onto your Sirin using the free Editor/Librarian software. Sirin also supports MIDI Program Change messages, allowing almost any MIDI controller to change presets on your Sirin.

NEXT PRESET:

GLIDE + OSCILLATOR 1 WAVE

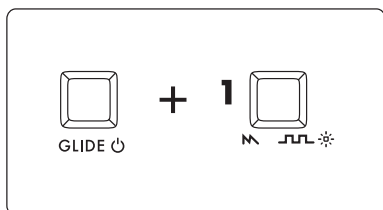

PREVIOUS PRESET:

GLIDE + OSCILLATOR 2 WAVE

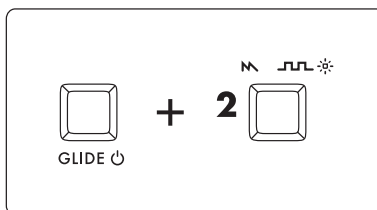

SAVE CURRENT PRESET:

GLIDE + RELEASE
(Hold both for 1 second).

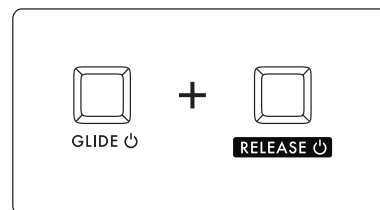

SAVE TO A NEW LOCATION:

GLIDE + RELEASE
(LEDs begin flashing)



SELECT A PRESET LOCATION:

GLIDE + OSCILLATOR 1 or 2

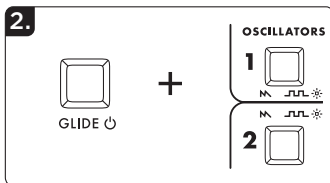

SAVE PRESET:

GLIDE + RELEASE
(Press RELEASE to cancel without saving)

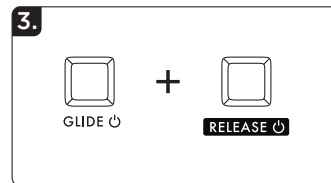

MODULATION SOURCES

Select from 6 different modulation sources: Triangle, Square, Ramp, Saw, Sample & Hold and Filter EG (MIDI CC 85)

HARD SYNC

VCO 2 Hard Sync allows a number of sounds to be created with Sirin (MIDI CC 80)

OSCILLATOR 2 MODULATION

Send modulation to Oscillator 2 only - ideal for use with Hard Sync (MIDI CC 112)

CV MAPPING

Your Sirin's Pitch and Volume CV inputs can be re-mapped to control any parameter on your Sirin, while the Gate input can be re-mapped to alter the state of any on/off parameters like Oscillator waveshape.

NOTE: All CV Mapping is configured in the free Sirin Editor/Librarian software.

CV TO MIDI CONVERSION

Sirin can convert multiple channels of Control Voltage to MIDI. This allows you to take CV sources like a Moog Mother-32 and translate the voltage into MIDI for CV control over plug-in effects, soft synths, or other MIDI gear.

WARNING: For optimal CV to MIDI conversion response, adjust the scale and range of the external control voltage to stay within 0 to +5 Volts. Do not apply a negative control voltage, or a CV greater than +5 Volts!

SHIFT PANEL FUNCTIONS QUICK REFERENCE GUIDE



The **GLIDE** switch on your Sirin can act as a “shift” key, allowing quick access to a number of extended functions directly from the panel.

MOD SOURCE SELECTION:
GLIDE + LFO RATE

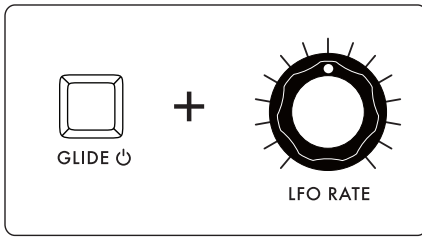

HARD SYNC ON/OFF:
GLIDE + VCO 2 LEVEL

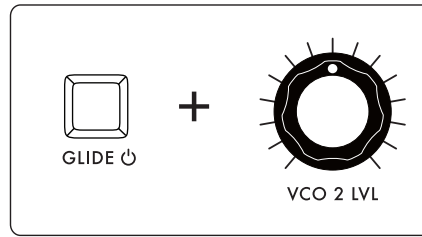

VCO 2 MOD ONLY ON/OFF:
GLIDE + VCO LFO AMT

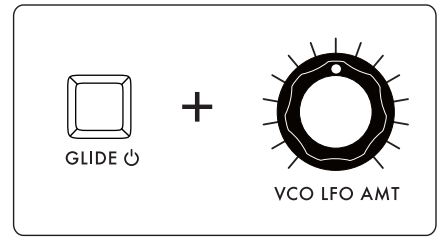

VCO 2 BEAT FREQUENCY:
GLIDE + VCO 2 FREQ

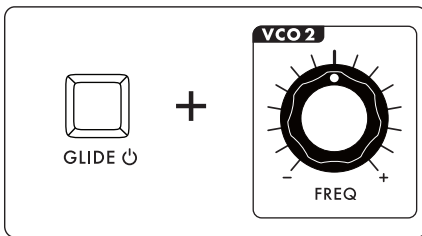

EXT. INPUT LEVEL:
GLIDE + VCO 1 LEVEL

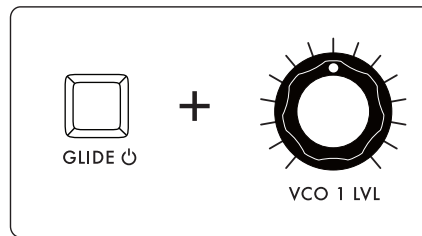

EG TRIGGER MODE:
GLIDE + AMP EG ATTACK

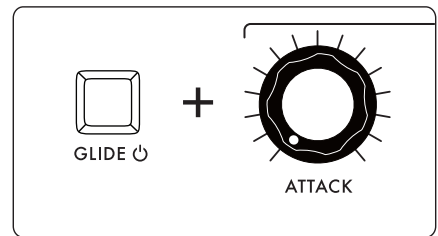

FILTER EG DELAY TIME:
GLIDE + FILTER EG ATTACK

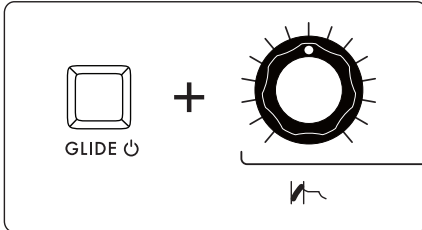

FILTER EG HOLD TIME:
GLIDE + FILTER EG DECAY/RELEASE

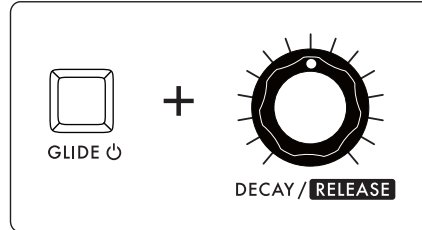

AMP EG HOLD TIME:
GLIDE + AMP EG DECAY/RELEASE

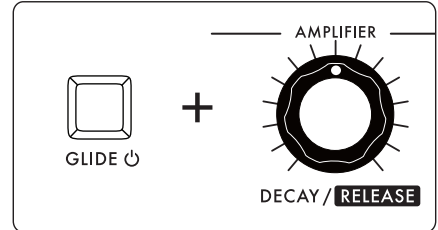

DRONE ON/OFF:
GLIDE + AMP SUSTAIN (Min to Max = ON)
GLIDE + AMP SUSTAIN (Max to Min = OFF)

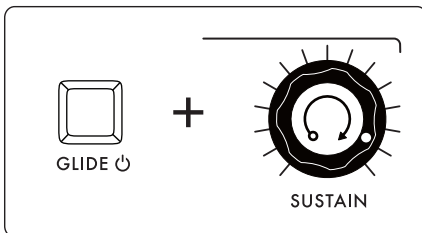

TOP OCTAVE WRAP ON/OFF:
GLIDE + GLIDE RATE

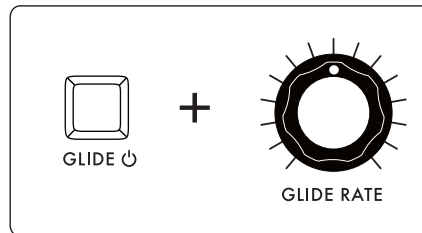

PANIC/ALL NOTES OFF:
GLIDE + AMP EG SUSTAIN TO ZERO.

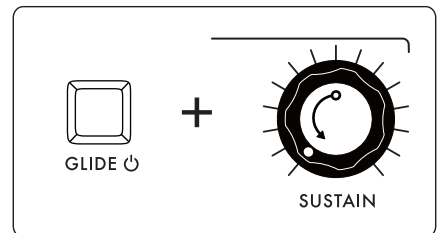

DECAY/RELEASE MODES

Press and hold the **RELEASE** switch for 1 second to change modes. The **RELEASE** switch LED will blink one time to indicate Mode 1, or two times to indicate Mode 2.

MODE 1: Decay and Release times are linked and the **RELEASE** switch enables or disables the Release stage of the envelope.

MODE 2: Decay and Release times are independent. If **RELEASE** is lit, the **DECAY/RELEASE** knob is editing Release time. If **RELEASE** is dark, the **DECAY/RELEASE** knob is editing Decay time.



SIRIN

USER'S MANUAL



SIRIN

Congratulations on your new Analog Synthesizer. Sirin, the Analog Messenger of Joy, is a limited-edition synthesizer module made in celebration of the Moog House of Electronicus Pop-up experience. Based on the legendary Moog Taurus Bass sound engine, and in the familiar Moog Minitaur form-factor, this new instrument features an adjusted frequency range capable of reaching notes up to D8. Sirin is an analog synthesizer module that empowers effortless expression through its classic knob-per-function design and compact form. Connect Sirin directly to any MIDI controller and immediately access a portable world of powerful analog sound, or hook up to a computer via USB to explore even deeper layers of sound design, where every parameter can be manipulated, automated, and recalled instantly using Sirin's dedicated Editor Librarian Software.

Sirin will bring you many happy years of creative and sonic enjoyment. We are sure you are anxious to start playing, so refer to the "Getting Started" guide or look over the Setup and Connections section to get going. At some point, we encourage you to spend some time with the manual to discover all that Sirin has to offer. *Don't forget - Experimentation and learning will reward you with a lifetime of rich synthesizer experiences.*



IMPORTANT SAFETY INSTRUCTIONS

PLEASE READ BEFORE USING THIS PRODUCT

When using Sirin, these basic precautions should always be followed.

1. Read all the instructions before using this product.
2. Do not use Sirin near water.
3. This product, in combination with an amplifier and headphones or speakers, may be capable of producing sound levels that could cause permanent hearing loss. Do not operate for a long period of time at a high volume level or at a level that is uncomfortable. If you experience any hearing loss or ringing in your ears, you should consult an audiologist.
4. Keep Sirin away from heat sources such as radiators, heat registers, and other products that produce heat.
5. The product should be connected to a power supply only of the type described in the operating instructions.
6. The power supply should be unplugged from the outlet when left unused for long periods of time.
7. Care should be taken so that liquids are not spilled into the front panel.
8. Sirin should be serviced by qualified personnel when:
 - a. Objects have fallen, or liquid has been spilled onto the product.
 - b. The product has been exposed to rain.
 - c. The product does not appear to operate normally or exhibits a marked change in performance.
 - d. The product has been dropped or the enclosure damaged.



DANGER -- INSTRUCTIONS PERTAINING TO RISK OF FIRE, ELECTRIC SHOCK, OR INJURY TO PERSONS: Do not open the chassis. There are no user serviceable parts inside. Refer all servicing to qualified personnel only.

CONTENTS

THE BASICS

Unpacking & Inspection	4
Setup and Connections	4
Overviews and Features	6
Signal Flow	8
Basic Operation	9

THE COMPONENTS

Oscillators	9
Glide	11
Mix	11
Filter	12
Envelopes	14
Release	15
Modulation	16
Volume	17
Input/Output Panel	18

MIDI OPERATIONS

MIDI CC Table	22
---------------	----

APPENDICES

A. MIDI Implementation Chart	25
B. Service & Support Information	26
C. Caring for Sirin	27
D. Specifications	27

UNPACKING AND INSPECTION

CHECK THE CONTENTS IN THE SHIPPING CARTON

The Sirin is shipped with the following items:

1. Sirin Analog Synthesizer
2. A 12VDC Power Adaptor
3. A “Getting Started” guide
4. Registration Card

WHAT YOU WILL NEED

1. A MIDI keyboard or MIDI controller
2. A MIDI cable
3. A USB cable to connect Sirin to a host computer (for USB MIDI)
4. A 1/4” instrument cable and amplifier, or a pair of headphones with an 1/8” plug

SETUP AND CONNECTIONS

NOTE: We encourage you to read the entire manual at some point to learn more about the instrument and gain a better understanding of what you can do with Sirin.

SET UP

Use care when unpacking your Sirin, and be sure to save the carton and all packing material in case you need to ship it for any reason.

CONNECT TO POWER & MIDI

Connect the supplied Power Adaptor to Sirin’s 12VDC power jack on the back of the unit. The Sirin’s universal power supply will operate with a power source from 100 to 240 Volts AC, 50/60Hz. Using a 5 Pin MIDI cable, make the connection between MIDI OUT of your MIDI controller and the MIDI IN on the Sirin. Sirin is set to receive messages on MIDI Channel 1, so make sure your controller is set to transmit on MIDI Channel 1. If you are using USB MIDI, connect the USB cable from Sirin to a USB port on your computer. Sirin’s USB drivers are automatically installed, and it will appear as ‘Moog Sirin’ (Mac OSX or Win 7) or ‘USB Audio Device’ (Win XP) in the MIDI Device selection options of your computer’s MIDI software.

POWER UP

Apply power to the Sirin and to your MIDI controller.

CONNECT TO AMPLIFIER

Set Sirin's volume control to minimum *before* connecting to an amplifier, mixer, or headphones. Set the amplifier volume to a comfortable listening level, and then *slowly* bring up the volume on Sirin as you play a few notes.

NOTE: Use caution when adjusting initial volume levels, especially if connected to a subwoofer.

START PLAYING

Play some notes, tweak some knobs and have some fun!

DOWNLOAD THE SIRIN EDITOR PROGRAM

Register your Sirin online at www.moogmusic.com/register to download the free Sirin Editor Program. This allows you to load and save patches and access all of Sirin's under the hood features. Registering your Sirin also initiates your warranty, and ensures you receive the latest software updates.

***NOTE:** A warm up period of about 15 minutes is recommended for reach concert pitch. The warm up period may be a little longer if the Sirin has been stored outside the recommended operating temperature range.*

Sirin's recommended operating temperature is between 50 and 100 degrees Fahrenheit. It is safe to operate the synthesizer outside of this range, but Sirin's voltage controlled oscillators may not remain in tune. It is also recommended that Sirin not be exposed to direct sunlight while operating.

OVERVIEW AND FEATURES

Sirin is a monophonic Analog Synthesizer with a 100% analog audio path. It is based on the legendary Taurus I and Taurus 3 Synthesizers. Sirin features 2 ultra-stable voltage controlled oscillators, a genuine Moog low pass filter, 2 envelope generators and a modulation circuit. Sirin has a classic one knob per function design in a rugged performance package that is small enough to take with you anywhere.

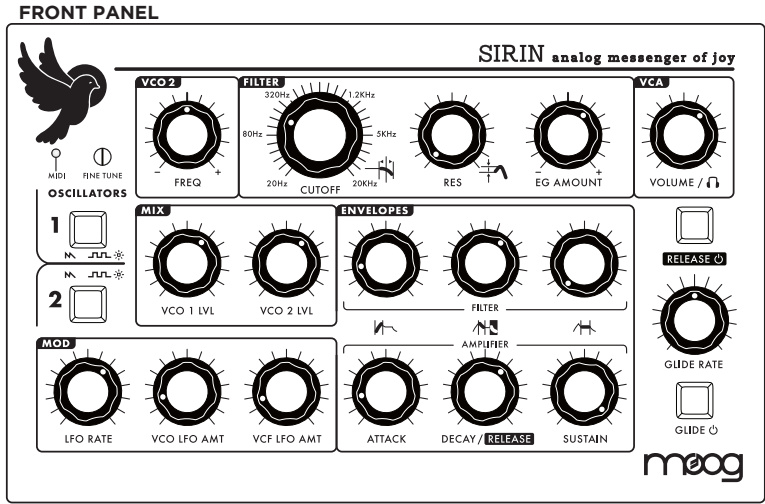

OSCILLATORS

Two Voltage Controlled Oscillators with selectable Sawtooth (original Taurus) and Square waveshapes.

MIX

Mixer for adjusting VCO levels independently.

FILTER

Classic Moog 24dB/Octave Low Pass Filter with adjustable Resonance.

ENVELOPES

Twin Minimoog style ADSR Envelope Generators for modulating the Filter (VCF) and Amplifier (VCA). The Envelope Decay and Release segments are controlled by the DECAY knob, while the Release segment is enabled or disabled via the RELEASE switch.

MOD

MIDI-syncable Low Frequency Oscillator (LFO) with Rate control and individual VCO and VCF AMOUNT controls.

BACK PANEL

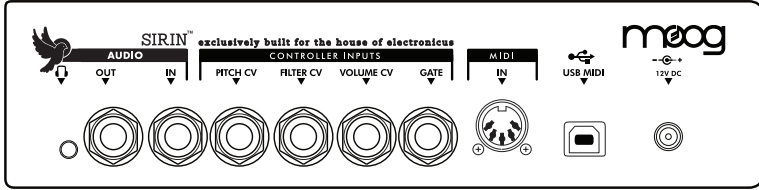

HEADPHONE OUT

1/8" Stereo Headphone Output.

AUDIO OUT

1/4" Unbalanced Output.

AUDIO IN

External Audio Input for processing audio through the Mixer and Filter section of the Sirin.

CONTROL INPUTS

Analog control inputs for Pitch, Filter, Volume and Gate. Use control voltage or a Moog EP3 expression pedal to connect and control the Sirin with everything from Moogerfoogers to modular systems.

MIDI

DIN MIDI and USB MIDI offer complete control of Sirin's sound engine.

SIGNAL FLOW

To understand how the Sirin generates sound, take a look at the diagram below. It shows the flow of Audio, Control Voltage and Modulation signals in the Sirin. Heavy lines indicate audio signals, which flow from left to right. Lighter lines indicate Control Voltages (CV's), which flow from the top and from the bottom. Dotted lines indicate Modulation routings.

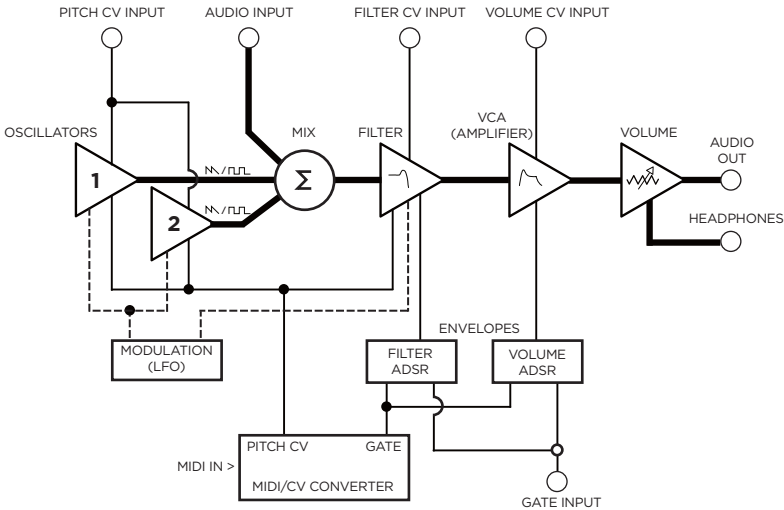

Sirin's source signals are created by two Voltage-Controlled Oscillators (VCO) which are mixed with the External Audio Input. The Mixer Output is routed to the Filter, where the tone is sculpted according to the Filter parameters and the Filter ADSR Envelope. The signal is then passed to the Amplifier (VCA) stage, where the Volume ADSR envelope shapes it. Finally, the signal is routed to the Output section, where the final level is set by the Volume control knob.

For most users, MIDI will be the main source of control for Sirin. Each time Sirin receives a MIDI "Note On" command, it produces a Pitch CV and Gate signal in response. The Pitch CV signal sets the Pitch of the Oscillators, while the Gate signal triggers the Filter and Volume ADSR Envelopes.

The Sirin can also be operated via CV and Gate trigger connections, for a more 'old school' method of control. Both control methods (MIDI & CV/Gate) can be used at the same time, although some combinations of control signals may cause unpredictable results.

NOTE: DIN MIDI IN is not passed to USB MIDI OUT

BASIC OPERATION

The Sirin responds to MIDI messages on both DIN and USB MIDI Inputs. In addition, Sirin's knobs and switches transmit MIDI Control Change (CC) commands via MIDI USB, allowing parameter adjustments to be captured by any MIDI-recording device. Sirin has an LED MIDI indicator that indicates MIDI activity on either the DIN MIDI or USB MIDI connector. To further extend the Sirin's capabilities, there are additional parameters that can be accessed via MIDI control. A complete list of all MIDI CC commands can be found on page 22-23.

THE COMPONENTS

OSCILLATORS

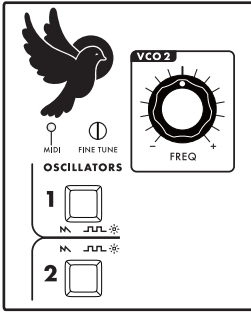

The Oscillators are the main sound source of Sirin. They create electronic vibrations that can be tuned and amplified into sound that we can hear. The Sirin's VCOs can produce a total musical range of 6 octaves.

OSCILLATOR 1 (VCO 1) serves as a master Oscillator to which OSCILLATOR 2 (VCO 2) is tuned. Two independent switches select the waveform for each Oscillator (Sawtooth or Square). A FINE TUNE control adjusts the master tuning of both Oscillators.

The frequencies of both Oscillators are affected by a number of sources. The main source is a 'Note On' command transmitted from an external MIDI controller or DAW. The 'Note On' command is translated into a Control Voltage that allows the Oscillators to be played in an equal-tempered scale. Other control sources include Sirin's GLIDE circuit, VCO 2 FREQ, the PITCH CV INPUT, the FINE TUNE control, and the output of the MODULATION (LFO) circuit.

PANEL CONTROLS FOR THE OSCILLATOR

OSCILLATOR 1 Switch (CC# 70):

Selects a Sawtooth (LED OFF) or Square wave (LED ON) for VCO 1.

OSCILLATOR 2 Switch (CC# 71):

Selects a Sawtooth (LED OFF) or Square wave (LED ON) for VCO 2.

VCO 2 FREQ (CC# 17):

Sets the frequency offset of VCO 2 from VCO 1. The offset range is +/-1 octave. Center position tunes VCO 2 in unison with VCO 1.

FINE TUNE:

Adjusts the frequency of both VCOs by approximately +/-1 semitone. The FINE TUNE control does not transmit MIDI.

MIDI ACCESSIBLE CONTROL**VCO 2 BEAT** (CC# 18):

Selects the fine frequency offset for VCO 2. The adjustment range is +/- 50 cents.
Default = 64.

NOTE SYNC (CC# 81):

When enabled, NOTE SYNC forces both oscillators to start at the same time, eliminating any phase differences at the start of each "Note On" command. This ensures energy is consistent at the start of each new note.
Default = OFF.

EXTERNAL CONTROL

The PITCH CV jack on the back panel is a CV input for external control of the Oscillator pitch. This input controls the frequencies of both Oscillators. A 1 volt change of this voltage will change the pitch by one octave. The jack accepts 0 to +5 volts, or an expression pedal like the Moog EP-3.

PERFORMANCE TIPS:

- *For punchy bass lines, try using NOTE SYNC to keep the energy at the beginning of each note the same.*
- *A steady control voltage applied to the PITCH jack will offset the base pitch of both oscillators. You can use this feature to transpose the oscillators to any desired interval.*
- *To recreate the classic Taurus sound, choose the Sawtooth wave for one or both oscillators.*

GLIDE



GLIDE (AKA 'portamento') is a musical effect that makes smooth changes in pitch between notes. Sirin's GLIDE RATE is adjustable from instantaneous to extremely long.

PANEL CONTROLS FOR GLIDE

GLIDE Switch (CC# 65):

Enables/Disables the GLIDE function. GLIDE is on when the LED is on.

GLIDE RATE (CC# 5):

Sets the rate of GLIDE that occurs when the note controlling Sirin changes.

MIDI ACCESSIBLE CONTROL

GLIDE TYPE (CC# 92):

Sirin offers three GLIDE types: Linear Constant Rate (LCR), Linear Constant Time (LCT), or Exponential (EXP). When LCR is selected, the GLIDE RATE stays the same regardless of the interval. When LCT is selected, the GLIDE TIME stays the same regardless of the interval. When EXP is selected, the GLIDE RATE follows an exponential curve that starts fast and then slows as it approaches the target note (like the Taurus).

Default = LCR.

LEGATO GLIDE (CC# 83):

Normally, GLIDE occurs with every new note. When LEGATO GLIDE is enabled, however, GLIDE is only applied when a new note is received while another note is still being held.

Default = OFF.

MIX (OSCILLATOR LEVELS)

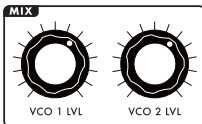

Each Oscillator (VCO 1 & VCO 2) has a dedicated level knob that allows you to control the relative strength of each oscillator from 0 to 100%. *NOTE: The VCOs begin to clip the filter at about 2 o'clock creating more aggressive sounds.*

PANEL CONTROLS FOR THE MIXER

VCO 1 LVL (CC# 15):

Sets the level of VCO 1.

VCO 2 LVL (CC# 16):
Sets the level of VCO 2.

MIDI ACCESSIBLE CONTROL

EXTERNAL INPUT LEVEL (CC# 27):

Adjusts the External Audio Input level. By default, the level is set for unity gain, but the level can be adjusted up to 200%
Default = 64.

FILTER

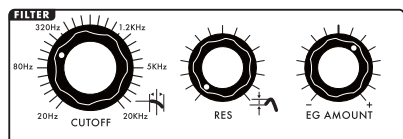

The FILTER is a classic Moog 24dB/ Octave Low-Pass Filter design with resonance. It has controls for CUTOFF frequency which determines the range of frequencies the filter will affect, as

well as RESONANCE, which determines how much emphasis is applied to the harmonics near the Cutoff frequency (see figure).

The FILTER provides either fixed or dynamic timbre modifications. Dynamic changes are provided by the Filter Envelope Generator (EG), a Low Frequency Oscillator (LFO), or by an externally applied Control Voltage.

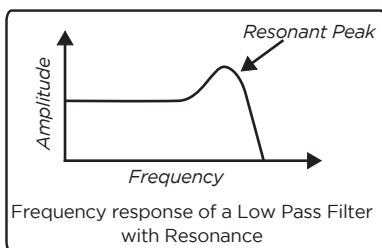

PANEL CONTROLS FOR THE FILTER

CUTOFF (CC# 19):

Adjusts the CUTOFF frequency of the Low Pass Filter from 20 Hz to 20 KHz. As the knob is rotated clockwise, the cutoff frequency is increased, allowing more harmonics to pass through the filter, resulting in a brighter sound. Conversely, as the knob is rotated counterclockwise, the sounds get darker. *NOTE: The Sirin may not produce sound when this control is turned all the way down.*

RESONANCE (RES) (CC# 21):

Sets the amount of signal sent from the FILTER output to be fed back into it's input. This creates a peak in the frequency that can be increased all the way to self-oscillation.

EG AMOUNT (CC# 22):

Determines how much the Filter Envelope Generator (EG) adds to or subtracts from the Filter Cutoff control setting. When the EG AMOUNT knob is set to positive (+), turn the FILTER CUTOFF knob left to hear the effect. When the EG AMOUNT knob is set to negative (-), turn the FILTER CUTOFF knob right to hear the effect. Note that if the Cutoff frequency is set very high, a positive EG Amount may have little or no noticeable effect, regardless of the setting. Similarly, if the Cutoff frequency is set low, a negative EG Amount may have little or no noticeable effect.

MIDI ACCESSIBLE CONTROL**FILTER KB TRACKING (CC# 20):**

Determines how the Filter Cutoff changes in response to MIDI Note On values. Filter tracking is adjustable from 0 to 200%.
Default = 32 (about 50%).

FILTER VELOCITY SENSITIVITY (CC# 89):

Sets the amount OF MIDI Note velocity to the Filter.
Default = 64.

EXTERNAL CONTROL

The FILTER CV jack on the back panel is an input for external control of the Filter Cutoff parameter. A voltage applied to this jack is added to the setting of the Filter Cutoff control. A one-volt change in the Control Voltage will change the cutoff frequency of the filter by about one octave. The jack accepts 0 to +5 volts, or an expression pedal like the Moog EP-3.

ENVELOPES

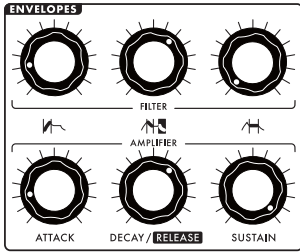

ENVELOPE GENERATORS (EGs) add motion to a sound after a note is played. The Sirin has two separate Minimoo style Envelope Generators that affect the brightness and loudness of the Sirin's sound by modulating the Filter Cutoff (VCF) and Volume (VCA).

The EGs are started by a Gate or MIDI Note message. Once started, their shape in time is set by the ATTACK, DECAY/RELEASE, and SUSTAIN controls, as well as the Release switch and length of the Note played.

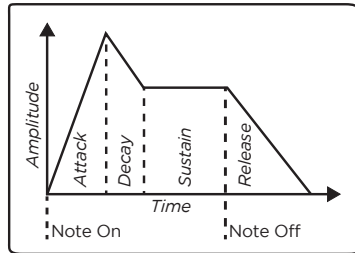

PANEL CONTROLS FOR THE ENVELOPES

FILTER ATTACK (CC# 23):

Sets the time it takes for the Attack portion of the Filter EG to rise from zero to maximum. The Attack time ranges from 1 msec to 30 seconds.

FILTER DECAY/RELEASE (CC# 24):

Sets the time for the Decay and Release portion of the Filter EG. When a note is held, and the Attack time end is reached, the Decay portion of the EG starts. During the Decay portion, the EG moves to the Sustain level. When a note is released, the EG moves back to zero at the rate set by this control. This time ranges from 1 msec to 30 seconds. The Release segment of the Envelope is determined by the state of the RELEASE switch (ON/OFF).

FILTER SUSTAIN (CC# 25):

Sets the Filter EG level after the Decay and before the Release portion. A note must be held longer than both the Attack and Decay time to reach the Sustain level. The level is adjustable from 0 to 100%.

AMPLIFIER ATTACK (CC# 28):

Sets the time it takes for the Attack portion of the Amplifier EG to rise from zero to maximum. The Attack time ranges from 1 msec to 30 seconds.

AMPLIFIER DECAY/RELEASE (CC# 29):

Sets the time for the Decay and Release portion of the Amplifier EG. When a note is held, and Attack time end is reached, the Decay portion of the EG starts. During the decay portion, the EG moves to the Sustain level. When a

note is released, the EG moves back to zero at the rate set by this control. The time ranges from 1 msec to 30 seconds. The Release segment of the Envelope is determined by the state of the RELEASE switch (ON/OFF).

AMPLIFIER SUSTAIN (CC# 30):

Sets the Amplifier EG level after the Decay and before the Release portion. A note must be held longer than both the Attack and Decay time to reach the Sustain level. The level is adjustable from 0 to 100%.

MIDI ACCESSIBLE CONTROL

OUTPUT (VCA) VELOCITY SENSITIVITY (CC# 90):

Sets the amount of MIDI Note velocity to the Amplifier.
Default = 64 (50%).

EXTERNAL CV CONTROL

The GATE jack on the back panel is a trigger input that accepts a +5V Gate signal. Applying a Gate signal causes both Envelopes (Amplifier and Filter) to trigger simultaneously. *NOTE: When a Gate signal is applied, it overrides triggering via MIDI. You will still be able to control the Oscillator pitch and Modulation amounts from a MIDI controller, but the envelopes will not retrigger until the Gate trigger is removed.*

RELEASE



The RELEASE switch enables or disables the Release segment of both Envelope Generators. When enabled, the Envelope Release time is the same as the Envelope Decay time, and the DECAY control adjusts the time for both segments. When disabled, the Release segment does not occur and the Envelope stops abruptly in response to a “Note Off” message (or when the Gate CV goes to zero).

PANEL CONTROL FOR RELEASE

RELEASE Switch (CC# 68):

Enables/Disables the Release function for both Envelope Generators. RELEASE is enabled when the switch LED is ON.

MODULATION (MOD)

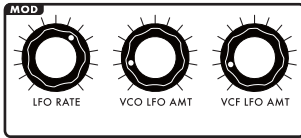

MODULATION is an important part in the creation of musically-expressive sounds. Sirin's MODULATION section provides an LFO with adjustable RATE and AMOUNT controls for the oscillators (VCO) and the Filter (VCF). The Low Frequency

Oscillator (LFO) is a signal used to move the pitch of VCOs and the Filter Cutoff up and down automatically. A LFO can be used to simulate vibrato, create wobbling filter sweeps, or make interesting synthesizer sounds.

PANEL CONTROLS FOR MODULATION

LFO RATE (CC# 3):

Sets the frequency of LFO Modulation. The range is from 0.01Hz to 100Hz.

VCO LFO AMOUNT (CC# 13):

Sets the maximum amount the LFO moves the VCOs pitch up and down, up to +/- 1 octave. Modulation affects both Oscillators. Amounts above MIDI Note 72 are clipped. If using a MIDI controller, the Mod Wheel (CC# 1) is used to fade the LFO Pitch Modulation in and out.

VCF LFO AMOUNT (CC# 12):

Sets the maximum amount the LFO moves the Filter Cutoff up and down, up to +/- 5 octaves. Amounts above 20KHz or below 20 Hz are clipped. If using a MIDI controller, the Mod Wheel (CC# 1) is used to fade the LFO Filter Modulation in and out.

MIDI ACCESSIBLE CONTROL

LFO MIDI SYNC ON/OFF (CC# 87):

Enables or Disables the ability of the Sirin's LFO to sync to MIDI Clock messages.

Default = ON.

LFO SYNC CLOCK DIVISION (CC# 86):

Selects the LFO Clock division when the LFO Sync Source is set to MIDI Clock. LFO Division Settings are listed on page 24. The LFO RATE control can also act as a Clock Divider.

Default = ON.

LFO KEY TRIGGER (CC# 82):

Re-triggers the start of the LFO cycle when a NOTE ON message or KB GATE Control Voltage is received.

Default = OFF.

NOTE: When the Sirin powers up, the settings on the VCO LFO AMOUNT and VCF LFO AMOUNT controls have a direct effect on the VCO and VCF. This behavior continues until Sirin receives a MIDI Mod Wheel command, from which point the Mod Wheel takes master control of the LFO modulation amount set by the Amount controls.

VOLUME (VCA)



The Sirin features a monophonic Audio Output and a Headphone Output; both outputs appear on the back panel. Both outputs are adjusted simultaneously by the VOLUME control.

PANEL CONTROL FOR VOLUME

VOLUME:

Adjusts the output of the Voltage Controlled Amplifier (VCA) and Headphone levels. Rotating the control fully clockwise produces the maximum output. Rotating the control fully counterclockwise silences the Sirin. The VOLUME control does not transmit or receive MIDI. This is a post VCA control.

MIDI ACCESSIBLE CONTROL

OUTPUT LEVEL (CC# 7):

Adjusts the Audio Output and Headphone volume levels.

VOLUME VELOCITY SENSITIVITY (CC# 90):

Velocity scales the amplitude of the Amplifier envelope Similar to traditional touch sensitivity.
Default = 64 (50%).

EXTERNAL CONTROL

The VOL CV jack on the back panel is an input for external control of the Output level. A voltage of 0 Volts silences the Sirin and a voltage of 5 Volts corresponds to the output level set by the VOLUME control knob. The jack accepts a positive Control Voltage from 0 to 5 Volts, or an expression pedal like the Moog EP-2.

INPUT/OUTPUT PANEL

The back panel provides all of the input and output connections. In addition to AUDIO INPUT/OUTPUT jacks, there are CV and GATE inputs, connections for MIDI, and the Power Connector. The Sirin does not have a power switch.

BACK PANEL

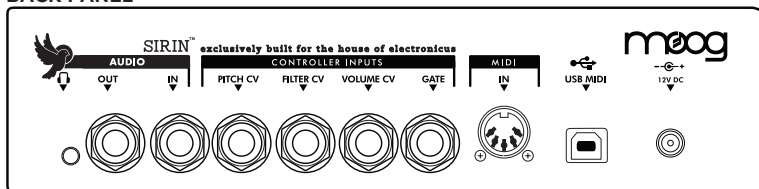

12VDC (POWER INPUT)

A barrel connector that accepts a +12VDC, tip positive power input from the power adaptor, which accepts 100-240 VAC, 50-60Hz.

CONTROLLER INPUTS

The PITCH, FILTER and VOLUME CV jacks supply power and will accept an expression pedal such as the Moog EP-2, or a Control Voltage from 0 to +5 Volts. The GATE input accepts a +5 Volt trigger signal.

MIDI (DIN AND USB)

Connections for DIN MIDI input and USB MIDI IN-OUT.

AUDIO IN

The AUDIO IN jack allows an external audio source to be mixed with the Sirin's VCOs, and then routed to the Filter for processing. Although the Sirin has no provisions for adjusting the level of this input on the front panel, the level is adjustable up to 200% via MIDI CC# 27.

AUDIO OUT

The AUDIO OUT jack provides an unbalanced line-level signal for connecting to an amplifier or mixer.

HEADPHONE OUTPUT

1/8" minijack for stereo Headphone Output. 32Ω or higher recommended impedance.

PERFORMANCE TIPS:

- *You can use the Sirin to process any audio signal simply by plugging into the AUDIO IN jack. To hear the external audio signal, you will need a MIDI NOTE ON message. To hear the external audio signal without issuing a MIDI NOTE ON message, apply +5V to the GATE jack. This will leave the Gate open, and the Amplifier Envelope will remain at its Sustain level until the Gate closes.*

- *The Sirin's audio input is not limited to processing monophonic signals - it can work well for processing polyphonic signals, too. For example, connect the MIDI Output of a MIDI-equipped polyphonic keyboard to the Sirin's AUDIO IN jack, and turn the MIX level of VCO 1 and VCO 2 all the way down on the Sirin. Now you have a polyphonic source affected by the Sirin's Filter and Envelope circuits - a great way to warm up a sterile digital signal!*

MIDI OPERATIONS

MIDI CHANNEL

Sirin sends and receives on a single MIDI channel. By default, the Sirin is set to MIDI Channel 1, but it can be set to any MIDI Channel (1-16). To change the MIDI Channel on the Sirin:

1. Connect your MIDI controller or DAW to the Sirin.
2. Adjust the controller (or DAW) to transmit the desired MIDI Channel.
3. On the Sirin; press and hold all four panel switches (VCO 1 Wave, VCO 2 Wave, GLIDE and RELEASE). The panel switch LEDs will blink, indicating that the Sirin is waiting to set the new MIDI channel. The next MIDI message that the Sirin receives (a Note On, CC, Pitch Bend etc...) will set the new channel.
4. Once in learn mode, press a key on the MIDI controller(or send MIDI data from the DAW). The Sirin will reset its MIDI channel to match the channel being sent.

Changes to the Sirin's MIDI channel are written to memory and are remembered on power down.

PITCH BEND RESPONSE

By default, the PITCH BEND RESPONSE of the Sirin is set to +/- 3 semitones. The Pitch Bend up and down values can be adjusted independently by issuing new values for MIDI CC#107 (Pitch Bend UP) and CC# 108 (Pitch Bend DOWN). See the MIDI CC Messages Table for the range of values.

MODULATION WHEEL (MOD WHEEL) RESPONSE

MIDI Mod Wheel messages control the maximum amount of modulation effect set by the VCO LMO AMT and VCF LFO AMT controls (MIDI CC# 1).

MIDI CONTROL CHANGE (CC) MESSAGES

The tables on the following pages list all MIDI CC messages for the Sirin. Messages shown with an (M) indicate parameters which are only accessible via MIDI. Bolded values indicate the appropriate range for 7-bit messages (MSB).

NOTES:

- *Sirin sends 7-bit MIDI CC messages for all parameters. It can receive either 7-bit or 14-bit values for the parameters controlled by knobs, but only 7-bit values for parameters controlled by switches.*

- *For all parameters, the MSB indicates the 'regular' CC number, and the LSB indicates the high-resolution 'fine' control value. If you are only sending 7-bit MIDI CC messages to the Sirin, use the MSB number by itself. Note that when MSB-only messages are issued, the value range is always 0-127.*

A NOTE ABOUT CONTROL PARAMETERS

LOCAL CONTROL OFF (CC# 122):

This parameter allows the front panel controls to send MIDI, but disconnects the Sirin sound engine from direct control by the panel. Per the MIDI spec, only values of '0' and '127' work (0 = OFF, 127 = ON). If you are connected to a DAW using USB MIDI patched through, you may need this to avoid feedback artifacts. After changing the state of LOCAL CONTROL on/off, the Sirin remembers the last setting after power down.

ALL SOUNDS OFF/ALL NOTES OFF (CC 120 or 123):

Both of these parameters are MIDI 'panic' functions that are used to silence hung MIDI notes. Controllers or DAWs may send one or the other command which is why the Sirin will respond to either.

SECTION	CONTROL/ PARAMETER	FUNCTION	CC	VALUE/RANGE
MOD(MODULATION)	LFO RATE	Adjusts the LFO frequency	3(MSB) 35(LSB)	0-127
	LFO VCO AMOUNT	Adjusts the modulation amount to the VCOs	13(MSB) 45(LSB)	0-127
	LFO VCF AMOUNT	Adjusts the Modulation amount to the VCF	12(MSB) 44(LSB)	0-127
	LFO MIDI SYNC (M)	Enables or disables ability of LFO to sync with MIDI CLOCK messages	87	0-63(INT) 64-127(MIDI CLOCK)
	LFO SYNC CLOCK DIV (M)	Sets the LFO synchronization clock divider	86	See table on page 24
	LFO KEY TRIGGER (M)	Re-triggers the LFO to the start of the cycle (Default is OFF)	82	0-63(OFF) 64-127(ON)
OSCILLATORS	VCO 1 WAVE	Selects the waveform of VCO 1	70	0-63(SAW) 64-127(SQR)
	VCO 2 WAVE	Selects the waveform of VCO 2	71	0-63(SAW) 64-127(SQR)
	VCO 2 FREQ	Adjusts the frequency of VCO 2	17(MSB) 49(LSB)	0-127 (64 is center)
	VCO 2 BEAT (M)	Adjusts the beat frequency of VCO 2 (Default is 64)	18(MSB) 50(LSB)	0-127
	NOTE SYNC (M)	Enables/disables Note Sync (Default is off)	81	0-63(OFF) 64-127(ON)
	GLIDE RATE	Adjusts the Glide (portamento) rate time	5(MSB)	0-127
	GLIDE SWITCH	Sets the state of the GLIDE switch (Glide is enabled when LED is lit)	65	0-63(OFF) 64-127(ON)
	GLIDE TYPE (M)	Selects the type of Glide; Linear Constant Rate, Linear Constant Time, or Exponential.	92	0-42(LCR) 43-84(LCT) 85-127(EXP)
	LEGATO GLIDE (M)	Sets the state of the Legato Glide parameter when GLIDE is enabled (Default is OFF)	83	0-63(Always Glide) 64-127(Glide on legato notes only)
MIXER	VCO 1	Adjusts the level of VCO 1	15(MSB) 47(LSB)	0-127
	VCO 2	Adjusts the level of VCO 2	16(MSB) 48(LSB)	0-127
	EXTERNAL IN LEVEL (M)	Adjusts the level of the External Audio Input (Default is 64 = 50% level)	27(MSB) 59(LSB)	0-127
FILTER	CUTOFF	Adjusts the Filter Cutoff frequency	19(MSB) 51(LSB)	0-127
	RESONANCE	Adjusts the Filter Resonance parameter	21(MSB) 53(LSB)	0-127
	EG AMOUNT	Adjusts the EG amount affecting the cutoff	22(MSB) 50(LSB)	0-127
	FILTER KB TRACK (M)	Sets the amount of keyboard tracking for the filter (Default is 32 - about 50%)	20(MSB) 54(LSB)	0-127
	FILTER VELOCITY SENSITIVITY (M)	Sets the amount of filter velocity sensitivity (Default is 64 - 50%)	89	0-127

SECTION	CONTROL/ PARAMETER	FUNCTION	CC	VALUE/RANGE
ENVELOPES	VCF ATTACK	Adjusts the filter envelope attack time.	23(MSB) 55(LSB)	0-127
	VCF DECAY/ RELEASE	Adjusts the filter envelope decay and release time	24(MSB) 56(LSB)	0-127
	VCF SUSTAIN	Adjusts the filter envelope sustain level	25(MSB) 57(LSB)	0-127
	VCA ATTACK	Adjusts the volume envelope attack time	28(MSB) 60(LSB)	0-127
	VCA DECAY/ RELEASE	Adjusts the volume envelope decay and release time	29(MSB) 61(LSB)	0-127
	VCA SUSTAIN	Adjusts the volume envelope sustain level	30(MSB) 62(LSB)	0-127
	RELEASE SWITCH	Sets the state of the Release parameter (enabled when LED is lit)	72	0-63(OFF) 64-127(ON)
	TRIGGER MODE (M)	Sets the state of the envelope trigger (Default is Legato ON)	73	0-42(LEGATO ON) 43-84(LEGATO OFF) 85-127(EG RESET)
VOLUME	VCA (OUTPUT) LEVEL (M)	Adjusts the audio output and headphone volume.	7(MSB) 39(LSB)	0-127
	VOLUME VELOCITY SENSITIVITY(M)	Sets the amount of volume velocity sensitivity (Default is 64 = 50%)	90	0-127
KEYBD RESPONSE	KEY PRIORITY(M)	Sets the Note Priority (Default is last)	91	0-42(LOW) 43-84(HIGH) 87-127(LAST)
MOD WHEEL RESPONSE	MOD WHEEL(M)	Modulation performance control	1(MSB) 33(LSB)	-
PITCH WHEEL RESPONSE	BEND UP AMOUNT (M)	Pitch Wheel 'UP' performance control (Default = +3 semitones)	107	0-15(OFF) 16-31(2 SEMITONES) 32-47(3 SEMITONES) 48-63(4 SEMITONES) 64-79(5 SEMITONES) 80-95(7 SEMITONES) 96-111(12 SEMITONES) 112-127(24 SEMITONES)
	BEND DOWN AMOUNT(M)	Pitch Wheel 'UP' performance control (Default = -3 semitones)	108	
CONTROL (SEE NOTE 1)	LOCAL CONTROL OFF(M)	Sets the state of the Local Control OFF parameter (Default is 127)	122	0 = OFF 127 = ON
	ALL SOUNDS OFF (M)	MIDI Panic message (Shuts off hung MIDI notes)	120	Any Value
	ALL NOTES OFF (M)	MIDI Panic message (Shuts off hung MIDI notes)	123	Any Value

MIDI CC VALUES FOR THE LFO CLOCK DIVIDER (CC# 86)

TIME VALUE	DIVISION	VALUE
1/64 Note Triplet	1/64 T	122-127
1/32 Note Triplet	1/32 T	116-121
1/32 Note	1/32	110-115
1/16 Note Triplet	1/16 T	104-109
1/16 Note	1/16	98-103
1/8 Note Triplet	1/8 T	92-97
Dotted 1/16 Note	1/16 DOT	86-91
1/8 Note	1/8	80-85
1/4 Note Triplet	1/4 T	74-79
Dotted 1/8 Note	1/8 DOT	68-73
1/4 Note	1/4	61-67
1/2 Note Triplet	1/2 T	55-60
Dotted 1/4 Note Triplet	1/4 DOT	49-54
1/2 Note	1/2	43-48
Whole Note Triplet	WH T	37-42
Dotted 1/2 Note	1/2 DOT	31-36
Whole Note	WH	25-30
Whole Note + Half Note	WH + 1/2	19-24
2 Whole Notes	2 Whole	13-18
3 Whole Notes	3 Whole	7-12
4 Whole Notes	4 Whole	0-6

APPENDIX A - MIDI IMPLEMENTATION CHART

FUNCTION	TRANSMITTED	RECOGNIZED	REMARKS
BASIC CHANNEL			
Default Changed	1 1-16	1 1-16	User Selectable
MODE			
Default Messages Altered	NO NO NO	4 NO NO	Note Priority MIDI CC# 91
NOTE NUMBER	NO	0-127	
VELOCITY			
Note On Note Off	NO NO	YES NO	
AFTER TOUCH	NO	NO	
PITCH BEND	NO	YES	Programmable from 0 ± 24 Semitones
CONTROL CHANGE	YES	YES	1,3,5,7,12,13,15-25, 27-30,33,35,37,39, 44,45,47-57,59-62, 65,70-73,81-83,86, 87,89-92,107,108, 120,122,123
PROGRAM CHANGE	YES	YES	
SYSTEM EXCLUSIVE	YES	YES	
SYSTEM COMMANDS			
Song Position Song Selection Tune	NO NO NO	NO NO NO	
SYSTEM REAL TIME			
Clock Commands	NO NO	YES YES	Receives Timing Clock
AUX MESSAGES			
Local Off All Notes Off Active Sense System Reset	NO NO NO NO	YES YES NO NO	

APPENDIX B - SERVICE AND SUPPORT INFORMATION

MOOG'S STANDARD WARRANTY

Moog warrants its products to be free of defects in materials or workmanship and conforming to specifications at the time of shipment. The Warranty Period is one year from the date of purchase. If, in Moog's determination, it has been more than five years since the product shipped from our factory, it will be at Moog's discretion whether or not to honor the warranty without regard to the date of the purchase. During the Warranty Period, any defective products will be repaired or replaced, at Moog's option, on a return-to-factory basis. This warranty covers defects that Moog determines are no fault of the user.

The Moog Limited Warranty applies to USA purchasers only. Outside the USA the warranty policy and associated service is determined by the laws of the country of purchase and supported by our local authorized distributor. A listing of our authorized distributors is available on moogmusic.com.

If you purchase outside of your country, you can expect to be charged for warranty as well as non-warranty service by the service center in your country.

RETURNING YOUR PRODUCT TO MOOG MUSIC

You must obtain prior approval in the form of an RMA (Return Material Authorization) number from Moog before returning any product. Email techsupport@moogmusic.com for the RMA # via email or call us at (828) 251-0090. All products must be packed carefully and shipped with the Moog supplied power adapter. The Moog Sirin must be returned in the original inner packing including the cardboard inserts. Sorry, the warranty will not be honored if the product is not properly packed. Once you have received the RMA# and carefully packed your Moog, ship the product to Moog Music Inc. with transportation and insurance charges paid, and include your return shipping address.

MOOG MUSIC
160 Broadway St.
Asheville NC, 28801

WHAT WE WILL DO

Once received, we will examine the product for any obvious signs of user abuse or damage as a result of transport. If the product abused, damaged in transit, or is out of warranty, we will contact you with an estimate of the repair cost. Warranty work will be performed and Moog will ship and insure your product to your United States address free of charge.

HOW TO INITIATE YOUR WARRANTY

Please initiate your warranty online at www.moogmusic.com/register. If you do not have web access, please call (828) 251-0090 to register your product.

APPENDIX C - CARING FOR THE SIRIN

Clean the Sirin with a soft, slightly moist cloth only – do not use solvents or abrasive detergents. Heed the safety warnings at the beginning of the manual. Don't drop the unit. If you are shipping your Sirin to the factory for servicing, we recommend using the original shipping carton, or an ATA approved Road Case.

AN IMPORTANT NOTE ABOUT SAFETY: Do not open the chassis. There are no user serviceable parts in the Sirin. Maintenance of the Sirin synthesizer should be referred to qualified service personnel only.

APPENDIX D - SPECIFICATIONS

TYPE: Programmable Monophonic Analog Synthesizer

SYNTH ENGINE:

Oscillator Section:

- OSCILLATOR 1:
Wave: Sawtooth/Square
Level: 0 to 100%
- OSCILLATOR 2:
Frequency: +/-12 Semitones
Wave: Sawtooth/Square
Level: 0 to 100%
- GLIDE RATE: 0 to 100%

Filter Section:

- CUTOFF: 20Hz to 20KHz
- RESONANCE: 0 to Self-Oscillation
- FILTER ENV. AMOUNT: -100% TO +100%

Envelope Generator Section (x2):

- ATTACK TIME: 1 msec to 30 sec
- DECAY TIME: 1 msec to 30 sec
- SUSTAIN LEVEL: 0 to 100%
- RELEASE TIME: 1 msec to 30 sec
- RELEASE: On/Off

Modulation Section:

- LFO RATE WITH RATE LED: 0.01 to 100Hz
- WAVE: Triangle
- AMOUNT TO VCO: 0 to 100%
- AMOUNT TO VCF: 0 to 100%

APPENDIX D - SPECIFICATIONS

PERFORMANCE CONTROLS:

- FINE TUNE: +/- 1 Semitone
- GLIDE: On/Off
- RELEASE: On/Off
- MASTER VOLUME

REAR PANEL:

- 12VDC POWER INLET:
Accepts +12VDC, tip positive
- MONOPHONIC AUDIO IN (1/4" TS-UNBALANCED)
Accepts +4dBu line level signal
- MONOPHONIC AUDIO OUT (1/4" TS-UNBALANCED)
- HEADPHONE JACK (1/8" TRS STEREO MINIJACK)
- CONTROL VOLTAGE INPUTS:
Pitch CV: 0 to +5V
Filter CV: 0 to +5V
Volume CV: 0 to +5V
Gate: +5V trigger
- DIN MIDI: MIDI Input
- USB MIDI: MIDI input, MIDI Output

DIMENSIONS:

- 8.75" x 5.12" x 3.12"
- (222.3mm x 130.2mm x 79.4mm)

WEIGHT:

- 2.5 lb
- (1.2 kg)

OPERATING SYSTEM:

- FLASH UPGRADEABLE VIA MIDI SYSEX

POWER CONSUMPTION:

- 7 WATTS

*Specifications subject to change without notice

©2018 MOOG MUSIC INC. | 160 Broadway St. Asheville, NC 28801
Moog is a registered trademark of Moog Music Inc.
The Moog Wordmark is a registered trademark of Moog Music Inc.
The Moog Icon is a registered trademark of Moog Music Inc.
Sirin is a trademark of Moog Music Inc.

WWW.MOOGMUSIC.COM