

X5D

X5

MUSIC SYNTHESIZER

GENERAL
MIDI
INSTRUMENT

Owner's Manual

 AI² Synthesis System

KORG

Ⓔ ①

THE FCC REGULATION WARNING

This equipment generates and uses radio frequency energy and if not installed and used properly, that is, in strict accordance with the manufacturer's instructions, may cause interferences to radio and television reception. It has been type tested and found to comply with the limits for a class B computing device in accordance with the specifications in Subpart J of Part 15 of FCC Rules, which are designed to provide reasonable protection against such interference in a residential installation. However, there is no guarantee that interference will not occur in a particular installation. If this equipment does cause interference to radio or television reception, which can be determined by turning the equipment off and on, the user is encouraged to try to correct the interference by one or more of the following measures:

- Reorient the receiving antenna.
- Relocate the equipment with respect to the receiver.
- Move the equipment away from the receiver.
- Plug the equipment into a different outlet so that equipment and receiver are on different branch circuits.

If necessary, the user should consult the dealer or an experienced radio/television technician for additional suggestions. The user may find the following booklet prepared by the Federal Communications Commission helpful: "How to Identify and Resolve Radio-TV Interference Problems". This booklet is available from the US Government Printing Office, Washington, D.C. 20402, stock No. 004-000-00345-4.

CANADA

THIS DIGITAL APPARATUS DOES NOT EXCEED THE "CLASS B" LIMITS FOR RADIO NOISE EMISSIONS FROM DIGITAL APPARATUS SET OUT IN THE RADIO INTERFERENCE REGULATION OF THE CANADIAN DEPARTMENT OF COMMUNICATIONS.

LE PRESENT APPAREIL NUMERIQUE N'EMET PAS DE BRUITS RADIOELECTRIQUES DEPASSANT LES LIMITES APPLICABLES AUX APPAREILS NUMERIQUES DE LA "CLASSE B" PRESCRITES DANS LE REGLEMENT SUR LE BROUILLAGE RADIOELECTRIQUE EDICTE PAR LE MINISTERE DES COMMUNICATIONS DU CANADA.

Precautions

■ Location

Using the unit in the following locations can result in a malfunction.

- In direct sunlight
- Locations of extreme temperature or humidity
- Excessively dusty or dirty locations
- Locations of excessive vibration

■ Power supply

Please connect the supplied AC adaptor to an AC outlet of the correct voltage. Do not connect it to an AC outlet of voltage other than that for which your unit is intended.

■ Interference with other electrical devices

This musical instrument contains a microcomputer. Radios and televisions placed nearby may experience reception interference. Operate this unit at a suitable distance from radios and televisions.

■ Handling

To avoid breakage, do not apply excessive force to the switches or controls.

■ Care

If the exterior becomes dirty, wipe it with a clean, dry cloth. Do not use liquid cleaners such as benzene or thinner, or cleaning compounds or flammable polishes.

■ Keep this manual

After reading this manual, please keep it for later reference.

■ Keeping foreign matter out of your equipment

- Never set a cup, vase, or any other container with liquid in it on top of this equipment. If liquid gets into the equipment, it could cause a breakdown, fire, or electrical shock.
- Be careful not to let metal objects get into the equipment. If something does slip into the equipment, turn off the power switch and unplug the AC adaptor from the wall outlet. Then contact your nearest Korg dealer or the store where the equipment was purchased.

X5 Back-up Battery

The X5 uses a back-up battery to prevent memory loss when the power is turned off. If the display shows "Battery Low",

the battery should be replaced. Consult the nearest Korg Service Center or dealer.

Note: Description in this manual applies to both X5 and X5D, and name X5 will appear for the description, except for the following specifications. X5D or X5 will appear wherever these specifications are referred in the manual.

	X5D	X5
Number of Multisounds	430	340
Number of Drum Sounds	215	164
Number or Preset Data	Program, Combination: 200 each (100 in PRE-a, 100 in PRE-b) Drum Kits: 4 (2 in PRE-a, 2 in PRE-b)	Program, Combination: 100 each Drum Kits: 2
Tone Generator	64 voices, 64 oscillator (in Single mode) 32 voices, 64 oscillator (in Double mode)	32 voices, 32 oscillator (in Single mode) 16 voices, 32 oscillator (in Double mode)
Waveform Memory	8M	6M
Demo Songs	2	1

Introduction

Features of the X5

Superior Sound with Korg's AI Square Synthesis System

The Korg X5 employs Korg's AI Square Synthesis System for all digital processing. From the tone generator—with its 6MB capacity on the X5 and 8MB on the X5D—to the filters, amplifier, and effect units, all audio is handled in the digital domain, which ensures the highest quality sound with absolutely no signal loss or deterioration in audio quality.

Based on state-of-art PCM technology, the AI Square Synthesis System is technology developed by Korg to capture the true essence of acoustic sound for use in a tone generator. Since its introduction in Korg's 01/W series, X2/X3, and i2/i3 synthesizers, the AI Square Synthesis System has received unqualified praise from musicians and artists throughout the world. With the X5, you will enjoy a richness and variety of sounds at a level of audio excellence that meets or exceeds the quality of audio CDs.

Multisounds Let You Create an Endless Variety of Sounds

The X5 contains 340 built-in Multisounds and the X5D contains 430 built-in Multisounds, which are multi-sampled PCM waveforms. These Multisounds allow you to simulate a range of musical sounds, from drums and percussion to piano, guitar, and trumpet parts. The X5 also features unique Multisounds—such as Synth and SE (Special Effects)—which provide a wide variety of flexible tools for sound creation. In fact, the X5 can generate a virtually endless variety of sounds.

These built-in Multisounds can be played in their unmodified form. They can also be modified to create the sound of various musical instruments, once they pass through a powerful VDF (filter) and VDA (amplifier). You can also add a rich expressiveness to a performance by altering the sound using the key touch velocity, or by adjusting the brightness of the sound or the depth of the vibrato using the modulation wheel.

236 Programs in Banks A and G

Bank A contains 100 Programs and Bank G contains 136 General MIDI (GM) compatible Programs. You can store your own Programs in Bank A.

Programs comprise the basic sounds of the X5. You can play different Programs in a song by simply switching them; you can even layer them in Combinations.

One Hundred Combination Slots Allow for an Endless Variety of Programs

Up to 100 Combinations can be stored in the X5. Up to eight Timbres (which are something like a container for sounds) can be assigned to each Program. In Combinations, you can layer or split multiple Programs by setting the Key Window or Velocity Window.

Combinations are powerful sound tools, especially for live performance. The Combination types layer, split, and velocity switch provide various sound structures.

Drum Kits Support a Variety of Rhythms

The X5D provides 215 types and the X5 provides 164 types of very popular drum sounds, including both drum and percussion sounds. You can create two Drum kits by assigning different drum sounds to each key on the keyboard. There are also eight ROM Drum kits available.

A Drum kit supports the rhythm of a song. Assigning a different drum sound to each key allows you to create a wide variety of rhythm parts. You can also edit the drum sounds using VDF, VDA, and effect units.

Digital Multi-Effects Processors: To Create and Add Dimension to Sounds

The X5 contains two independent digital multi-effects processors that can produce various effects such as reverb, delay, EQ, distortion, rotary speaker, etc. These effects are very useful when you want to create a new sound or add dimension to a sound. Some effects are a combination of two effects. Using the X5's two independent digital multi-effects processors, you can use up to four independent effects simultaneously.

The effects processors allow you to apply effects to and edit the sounds directly on the X5, instead of connecting external effects units. Placement settings are useful for processing the sound and adding width or depth to the sound. Each Program and Combination can have its own effect settings.

A wide range of scale types for numerous musical genres

In addition to the conventional equal temperament and pure temperament forms of tuning, a wide variety of scales is available. These scales include the Werkmeister III, Kirmberger III, Arabic, and Indonesian scales. These scales cover a broad range of musical genres, from classical to ethnic music, and prove extremely useful in the creation of high-fidelity simulations of ethnic musical instruments. You can also create your own, original scales.

Western music generally uses a twelve-tone equal temperament that allows you to play in any key and to transpose the key easily. However, the X5 provides various scale types that will make the sound of chords and the flow of phrases more beautiful, and that will allow you to perform music of temperaments other than equal temperament, such as the very complicated and subtle temperaments used in many ethnic musical pieces.

Multi Mode for GM

Since the X5 conforms to the GM (General MIDI) standard in Multi mode, it functions as a tone generator for computer music. You can also use GM songs (performance data designed for a GM tone generator). Using original Programs in Bank A or utilizing Key Window and Velocity Window allows for high-quality ensemble performances.

The X5 can be used as a GM tone generator with standard specifications. You can also combine different Programs and play original Programs via a computer.

Equipped with a personal computer interface

A computer interface is provided which enables direct connection to the serial ports of your personal computer, whether in the Apple Macintosh series or the IBM-PC compatible series.

Connection to a computer can be made through either a MIDI connection with a MIDI interface, or through a direct connection using a serial cable. Using the Korg MIDI Driver will allow you to control data transmission from MIDI OUT independently of the X5 tone generator, or to simultaneously control an external MIDI device.

Rich, large-scale ensembles with polyphony

The X5's 32-voice and the X5D's 64-voice polyphonic capability allows you to create complex ensemble and large-scale orchestral sounds. Combinations of multiple Programs and features in Multi mode will help you achieve such effects. The X5D can simulate a magnificent piano sound, replete with a damper pedal, and ensembles of various instrumental parts without any notes cutting off.

Extensive Presets Produce a Wide Range of Truly Practical Sounds

The X5 utilizes various Programs, Combinations, and Drum Kits as Preset data. You can load the sounds selected from 100 Programs, 100 Combinations, and 2 Drum Sounds on the X5, and the sounds from 200 Programs, 200 Combinations, and 4 Drum Sounds stored in Presets a and b on the X5D, into the Program or Combination memory for immediate use. The Preset Load operation loads data from all preset sounds to one particular sound slot.

The versatile editing functions of the X5 let you create original sounds very easily. On the other hand, it is quite a bit of work to create a good sound from scratch. Given such circumstances, Preset data can be very handy.

You can use the data immediately after you load a sound, choosing from a broad selection. You can use Preset data just as it is, without modification. You can also use Preset data as the raw material for sound editing. You may be able to glean a few ideas for sound-making from the Preset sounds.

How to use this manual

First, read from the "Introduction" to the "5. Application Guide" chapters to understand the setup, basic operation, and functions of the X5. These chapters explain the outline of the X5 and basic operation.

To obtain detailed information about X5's functions, read the "6. Parameter Guide" and "7. Appendix." These chapters explain various parameters and MIDI functions.

Note: *All the names of Programs, Combinations, and Multi setup that appear in this manual are just examples, and may not necessarily match the names you will see on the display of your X5.*

- Apple, the Apple logo, and Macintosh are registered trademarks; MIDI Manager and PatchBay are trademarks of Apple Computer, Inc.
- IBM is a registered trademark of International Business Machines Corporation.
- MS-DOS and Windows are trademarks of Microsoft Corporation.
- Other brand and product names are trademarks or registered trademarks of their respective holders.

Table of Contents

Introduction	i
Features of the X5	i
Chapter 1: Controls	1
Front Panel	1
Rear Panel	4
Chapter 2: Setting Up the X5	5
Connections	5
Basic Connection	5
Connecting a Foot Pedal/Volume Pedal	6
MIDI Connections	7
MIDI Connectors	7
Controlling the X5 from an External MIDI Device	7
Controlling an External MIDI Device from the X5	8
Connecting a Computer	9
Connecting an IBM PC (Compatible) Computer	9
Connecting an Apple Macintosh Computer	10
Setting Required when a Computer is Connected.....	11
Setting External Out Select (2C EXT OUT SEL)	11
Setting Computer Select (0E PC I/F CLK)	11
Chapter 3: Getting Around the X5	12
Power On/Off	12
Listening to the Demo Song	13
X5 Modes	14
Playing Programs	17
Playing Combinations	22
Performance Technique (Performance Function)	26
Performance in Multi Mode	28
Chapter 4: Editing	35
Basic Concepts	35
Sound Structure	35
EG and MG	36
Editing Programs	37
Adjusting the Attack of Programs	37
Adjusting the Decay	38
Adjusting the Release	39
Adjusting the Tonal Brightness	39
Editing a Multisound (Basic Waveform)	41
Adjusting Modulation	41
Adjusting Panpot	41
About Double Mode	42
Some Hints for Editing Programs	42
Editing Effects	43
Effect Types	43
Effects and Sound Level	45
Editing Combinations	46
Layering Multiple Programs	46
Adjusting the Volume	46
Adjusting the Key Window	47
Adjusting the Velocity Window	47
More About Combination Edit	47

Editing a Drum Kit	48
Preparing to Play a Drum Kit	48
Editing a Drum Kit	48
Creating a Drum Program Using a ROM Drum Kit	51
Program Sound Making: Practice	52
Protecting the Memory	52
Setting the Parameters	52
Sound Making	53
Writing Programs	61
Chapter 5: Application Guide	62
Performance Applications	62
Editing Applications	65
MIDI Applications	66
Useful Tips	67
Chapter 6: Parameter Guide	68
About This chapter	68
Program Parameters	69
Functions in Program Mode	69
COMBINATION Parameters	93
Functions in COMBINATION mode	93
Multi Setup Parameters	105
Multi Setup Functions	105
Effect Parameters	113
Effect Parameter Table	144
Global Parameters	146
Functions In Global Mode	146
Saving Global Setup Data	147
Appendix	163
Controller Event Edit Notes	163
MIDI Panpot, Send Data	165
Troubleshooting	166
General Error Messages	167
Program Edit Mode & Combination Edit Mode Error Messages ..	167
Global Mode Error Messages	167
Specifications	167
Options	167
MIDI Data Format	169
Program Change and Bank Select Reception in Combination Play Mode	179
PC Interface Technical Information Chart	179
Wiring Diagram of Dedicated Connecting Cables	180
Installing and Setting Up the KORG MIDI Driver	181
Setting Up the KORG MIDI Driver (Windows)	183
Installing the KORG MIDI Driver on a Macintosh Computer	184
Setting Up the KORG MIDI Driver for the Macintosh	185
MIDI File Translator	186
MIDI Implementation Chart	188
Voice Name List.....	190
INDEX	200

Chapter 1: Controls

Front Panel

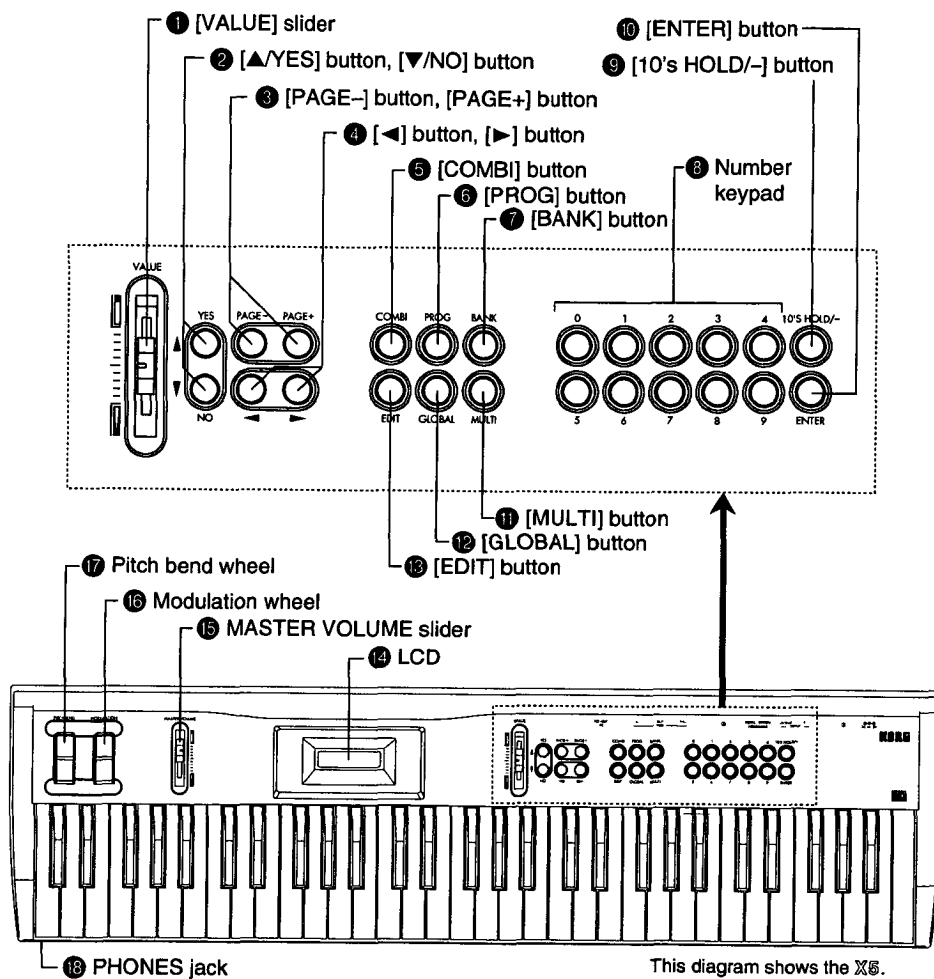

This diagram shows the X5.

1 [VALUE] slider

This slider is used to set parameter values. (A parameter is a value that you can change on the display.)

2 [▲/YES] button, [▼/NO] button

In Program Play mode and Combination Play mode, pressing the [▲/YES] button allows you to select the next Program and Combination respectively, and pressing the [▼/NO] button allows you to select the previous Program and Combination respectively. When the [10's HOLD/-] button is lit, pressing these buttons will increment or decrement the Program/Combination number in steps of 10.

In Program Edit mode, Combination Edit mode, Multi mode, and Global mode, these buttons can be used to increase/decrease parameter values. By pressing both buttons simultaneously in any of these modes, you can reset the parameter to its original value—that is, the value before you edited it. (This operation is called “Undo.”)

These buttons are also used when the X5 requires a yes or no answer from you on the LCD screen. For example, when the message “— OK?” appears, press the [▲/YES] button to continue, or the [▼/NO] button to cancel.

③ [PAGE-] button, [PAGE+] button

These buttons allow you to switch the page shown on the LCD screen. Press the [PAGE+] button to select the next page, and press the [PAGE-] button to select the previous page.

④ [◀] button, [▶] button

These buttons are used to move the flashing cursor around the LCD to select parameters. When one display page includes multiple LCD screens, you can switch screens by moving the cursor.

⑤ [COMBI] button

Press this button to select the Combination Play mode. Pressing this button repeatedly will toggle the displays for Timbres 1-4 and Timbres 5-8.

⑥ [PROG] button

Press this button to select the Program Play mode.

⑦ [BANK] button

Press this button to select banks in Program Play mode (A, G). Press this button to toggle between the selected parameter and its related parameter in Program Edit mode and Combination Edit mode. (see page 67.)

⑧ Number keypad

This keypad allows you to select Programs and Combinations by entering the corresponding number (two digits for Programs in Bank A and Combinations, three digits for Programs with numbers starting with 0-13, and two digits for subsequent Programs in Bank G). After entering the number, press the [ENTER] button to confirm the setting. When the [10's HOLD/-] button is on, you can enter only the first digit of the Program and Combination number; you cannot change the second (10's) digit. (see page 18.)

The keypad can also be used to specify parameter values. After entering the value, press the [ENTER] button to confirm the setting.

Entering a value using this keypad while holding down the [EDIT] button will take you to the specified page.

You can also use this keypad to enter numbers when renaming Programs and Combinations.

⑨ [10's HOLD/-] button

When the [10's HOLD/-] button is on in Program Play mode or Combination Play mode, you can enter only the first digit of the Program and Combination number. Pressing the [▲/YES] and [▼/NO] buttons changes the second (10's) digit.

This button is also used to enter negative parameter values. To make a negative value positive or vice versa, press the [10's HOLD/-] button.

⑩ [ENTER] button

When you specify a parameter value using the numeric keypad, press this button to enter (confirm) that value. To enter a note value (a position on the keyboard), play the corresponding key without pressing the [ENTER] button.

⑪ [MULTI] button

Press this button to select Multi mode.

⑫ [GLOBAL] button

Press this button to select Global mode.

⑬ [EDIT] button

Press this button to enter the corresponding edit mode for the current mode. For example, to select Program Edit mode, press the [EDIT] button while in Program Play mode. To select Combination Edit mode, press this button while in Combination Play mode.

During the edit operation, entering the page number while holding down this key will take you to the corresponding page.

14 LCD

This visual interface displays the current Program name and Combination name in Program Play mode and Combination Play mode, respectively. It displays parameters in other modes.

15 MASTER VOLUME slider

This slider adjusts the entire output volume of the X5. At the same time, it also controls the headphone volume.

16 Modulation wheel

This wheel adjusts the depth of modulation. Moving it forward will increase the modulation depth. It allows real-time control of the following parameters: Vibrato, Wow, and After Touch, and sends out various MIDI messages. It also allows Controllers 0–127 to be transmitted. Select one of these using 10A MG Wheel Select parameter in Global mode.

17 Pitch bend wheel

This wheel “bends” or changes the pitch. Moving this wheel forward will usually raise the pitch; moving it toward you will lower the pitch.

18 PHONES jack

Connect the headphones to this RCA stereo jack.

Rear Panel

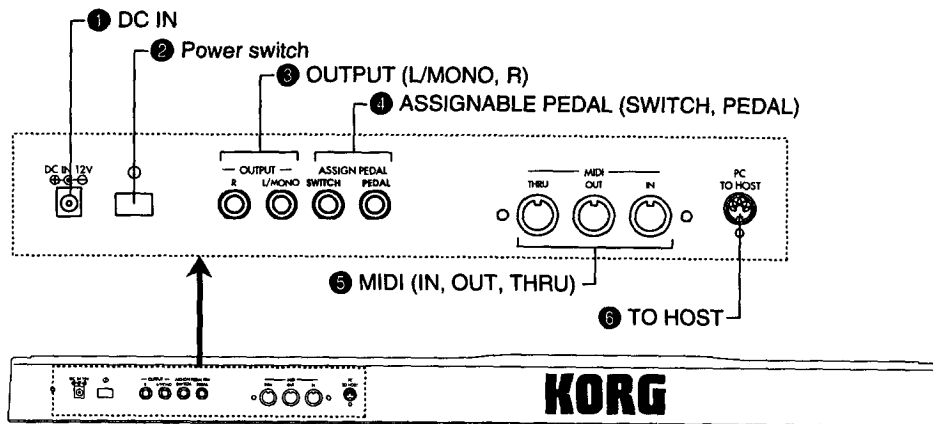

1 DC IN

Connect the AC adapter here.

Note: Do not use adapters other than the AC adapter that comes with the X5! Otherwise, a malfunction may occur.

2 Power switch (ⓐ)

This switch is used to power on and power off the X5.

3 OUTPUT (L/MONO, R)

These 1/4 inch phone jack connections should be connected to the inputs of a powered monitor, stereo amplifier, mixer, or multitracker. Use the L/MONO connection for mono playback.

4 ASSIGNABLE PEDAL (SWITCH, PEDAL)

An optional Korg PS1/2 foot pedal or Korg EXP-2, XVP-10 volume pedal can be connected here. A pedal can be set to perform one of many functions, such as selecting Programs and Combinations, performing a damper pedal effect, or controlling the volume.

5 MIDI (IN, OUT, THRU)

These connections are used to connect external MIDI instruments. MIDI IN receives MIDI data from the external MIDI instrument; MIDI OUT outputs MIDI data from the X5 to the connected MIDI instrument; and MIDI THRU outputs MIDI data received at the MIDI IN connection.

6 TO HOST

This connection is used to connect a computer to the X5 via an optional cable (AG-001/002) enabling the X5 to transmit and receive MIDI performance data, sound data, etc.

Chapter 2: Setting Up the X5

Connections

Basic Connection

See the figure below to connect the AC adapter and the audio cables. In order to take the best advantage of X5's high-quality sound, we recommend that you play the sound in stereo. For monaural connection, use the L/MONO jack.

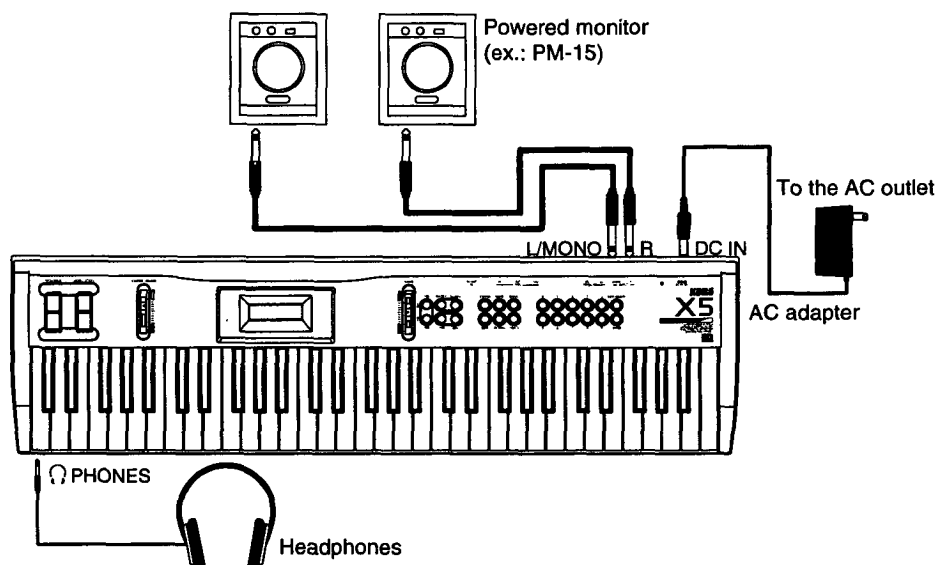

Connect the headphones to the PHONES jack located on the left edge of the unit's front panel.

Powered monitor/stereo amplifier

In order to play back the X5's high-fidelity sound, we recommend that you connect the X5 to a powered monitor (an amplifier-built-in speakers: such as an optional PM-15). If you are going to connect an audio stereo amplifier or other devices (such as a stereo radio or a cassette tape recorder), use a connector labeled "LINE IN" or "AUX IN" on those devices. (If necessary, use an adapter/cable with a converter plug.) If you connect the X5 to a domestic hi-fi system, be careful not to raise the volume level too high because you may damage the speakers.

You have finished the basic connection. In addition, you may also connect a computer or various MIDI devices, as well as a foot pedal or a volume pedal, as shown on the following pages.

Connecting a Foot Pedal/Volume Pedal

A foot pedal (such as an optional PS-1, PS-2, DS-1, or DS-2) connected to the X5 allows you to adjust various effects and sustain the sound (the same effect as a piano damper [sustain] pedal). A volume pedal (such as an optional EXP-2, XVP-10) connected to the X5 allows you to adjust the volume level during live performance.

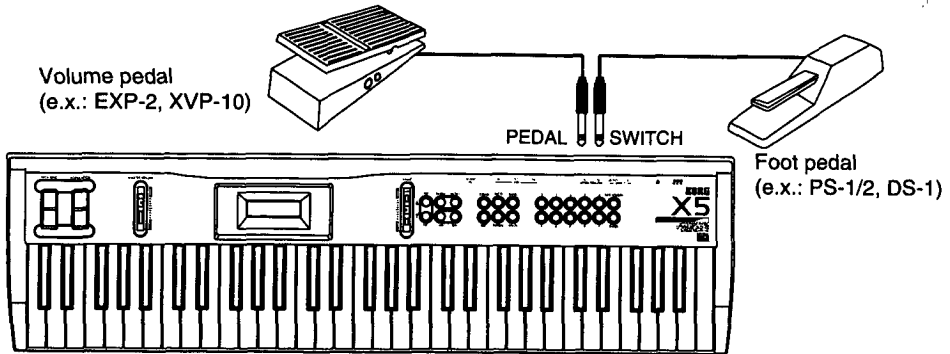

- Use the “9C Assignable Pedal/Switch & Polarity Setup” in Global mode (on page 161) to set the foot pedal polarity (ON/OFF condition). If the foot pedal operation is opposite to the effect (that is, the sound is sustained when you release the pedal), change the polarity.

MIDI Connections

By connecting external MIDI instruments to the MIDI connectors on the X5 using MIDI cables, you can play the X5 via an external MIDI instrument or play the external MIDI tone module from the X5 keyboard.

- MIDI connections are not necessary if you are playing the X5 as a stand-alone synthesizer.

MIDI Connectors

Use MIDI cables to connect MIDI devices, such as a computer or MIDI tone module, to the MIDI connectors on the X5.

There are three MIDI connectors: MIDI IN, MIDI OUT, and MIDI THRU. MIDI IN receives MIDI data from the external MIDI instrument; MIDI OUT outputs MIDI data from the X5 to the connected MIDI instrument; and MIDI THRU outputs MIDI data received at the MIDI IN connection.

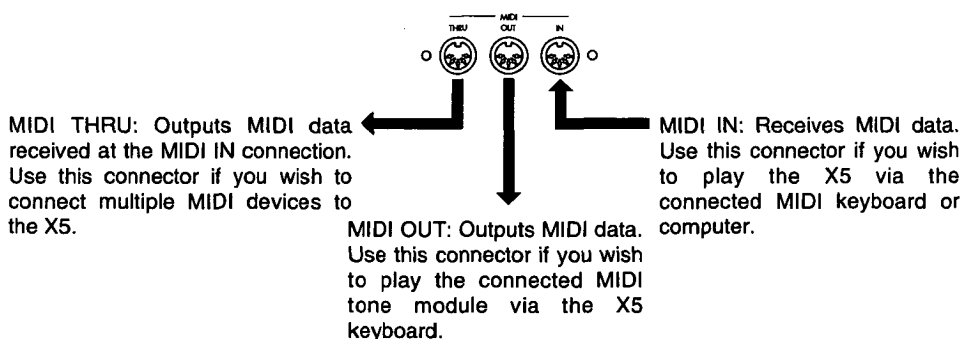

- You can connect multiple MIDI devices to the X5 using the MIDI THRU connector. However, we recommend that you connect no more than three devices to avoid possible malfunction. If you wish to connect more devices, use a MIDI Patchbay.

Controlling the X5 from an External MIDI Device

To control the X5 from an externally connected computer, sequencer, or other MIDI keyboard, connect the MIDI OUT connector of those devices to the MIDI IN connector of the X5 using a MIDI cable.

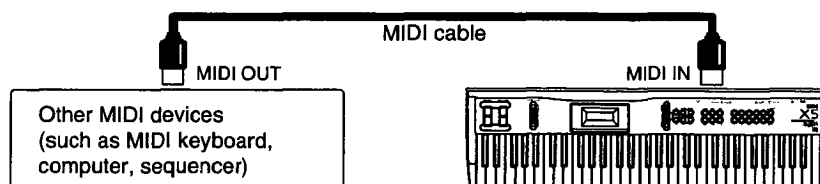

- You will need a MIDI interface to connect the computer to the X5. In addition to the MIDI connection, you can connect the computer using a special cable. (see page 9.)

Controlling an External MIDI Device from the X5

To record the performance of the X5 keyboard on a computer or sequencer, or to play an externally-connected MIDI tone module, connect the MIDI OUT connector of the X5 to the MIDI IN connector of the other MIDI device using a MIDI cable.

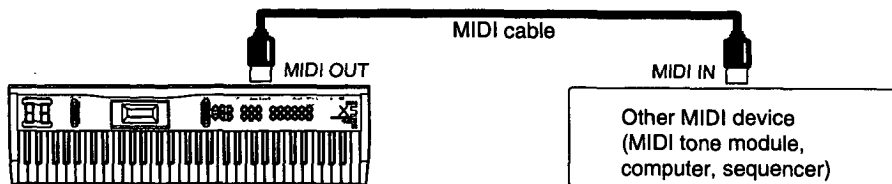

- Set 2C EXT OUT SEL of Global mode to "MIDI" to transmit the MIDI data of the X5 keyboard performance from the MIDI OUT connector (see page 11). The factory default setting is "MIDI".
- You will need a MIDI interface to connect the computer to the X5. Besides the MIDI connection, you can connect the computer using a special cable.

Connecting the computer/sequencer to the X5

If you wish to record the X5 keyboard data to a computer or sequencer, and also play music on the X5 (that is, using the X5 as a MIDI keyboard for inputting data or as a MIDI tone generator), connect the MIDI IN and MIDI OUT connectors on the X5 to the MIDI OUT and MIDI IN connectors of the computer or sequencer, respectively. At this time, if the Echo Back setting of the computer or sequencer (this function transmits MIDI data received at MIDI IN directly to MIDI OUT) has been ON, the keyboard sound and the Echo Back sound will overlap. If you wish to use this connection (see the figure below), set Local Off on the X5 (this function disconnects the keyboard section from the internal tone generator). You can access the Local Off setting at "2B Local Control" of Global mode (see page 33, 152).

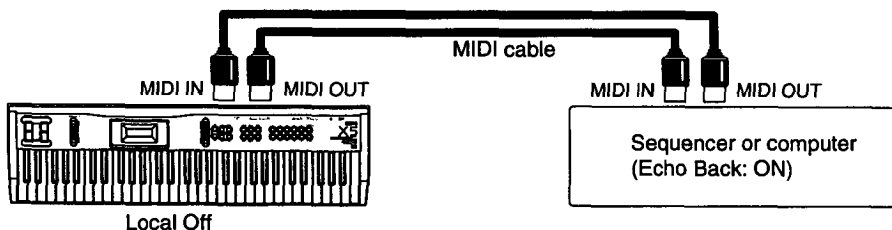

- When you set Local Off on the X5, the X5 itself will not produce the sound (when you play the keyboard). Be sure to set Local On when you are playing only the X5.

Connecting a Computer

By connecting a computer to the X5 using a special cable, you can play the X5 sound from the computer, or record your keyboard performance on the X5 to the computer. In addition, you can control other connected MIDI devices from the computer using the X5 as a MIDI interface.

You may connect the following types of computers to the X5 using a dedicated cable (see page 180).

IBM PC (compatible): Optional connection kit AG-001 (Cables, Software “KORG MIDI Driver”)

Apple Macintosh series: Optional connection kit AG-002 (Cables, Software “KORG MIDI Driver”)

You may not be able to use these connections depending on the model of the computer or the type of application software used on the computer.

- Do not connect the X5 to a single external device via both MIDI OUT and TO HOST at the same time. Be sure to use only one of these connectors.

Connecting an IBM PC (Compatible) Computer

Connect the serial port (COM port) of the IBM PC (compatible) computer to the TO HOST connector on the X5 using a special cable (optional AG-001).

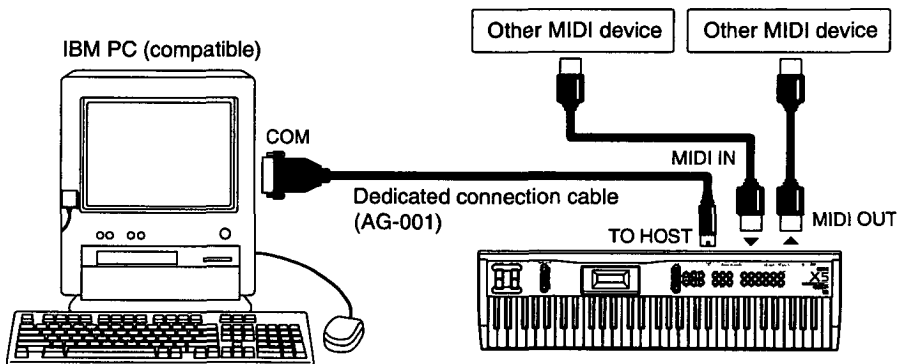

To transmit keyboard performance data from the TO HOST connector of the X5 to the computer, set 2C EXT OUT SEL of the Global mode to PCIF (see page 11).

- You may not be able to use this connection, depending on the model of the computer or the type of sequencer software. Application software that is not compatible with Windows MME (Multimedia Extensions) or Windows 3.1 (except for those specifically supporting the X5) cannot be used with this connection.
- If the computer has a 25-pin serial port, use an optional AG-004 9-to-25-pin adapter.

Set 0E PC I/F CLK of the Global mode to “38.4kBPS” (see page 11).

If you use this connection with Windows MME or Windows 3.1, you need to install the Korg MIDI Driver. Refer to page 181 for installation information.

Connecting an Apple Macintosh Computer

Connect the modem port or printer port of the Apple Macintosh computer to the TO HOST connector of the X5 using a special cable (optional AG-002).

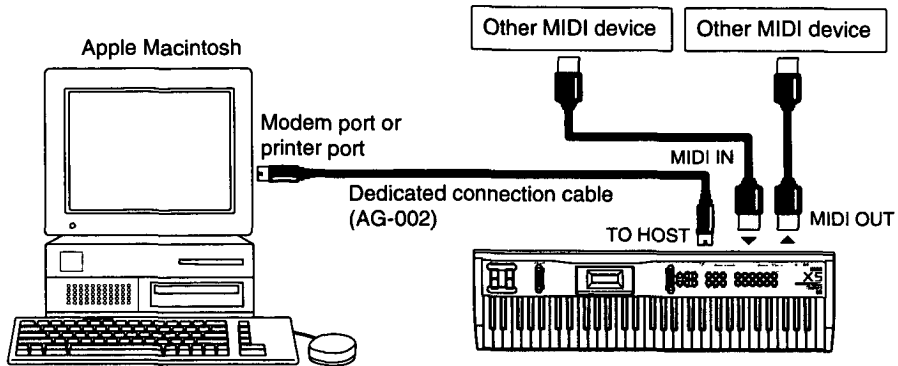

To transmit keyboard performance data from the TO HOST connector of the X5 to the computer, set 2C EXT OUT SEL of Global mode to PCIF (see page 11).

- This connection might not be used, depending on the model of the computer or the type of sequencer software.
- If your sequencer software has a clock setting, set the clock to 1MHz.

Set 0E PC I/F CLK of the Global mode to "31.25kBPS" (see page 11).

Installing the Korg MIDI Driver allows the X5 to output data from an internal tone generator via MIDI separately from MIDI OUT data. Refer to page 184 for installation information.

Setting Required when a Computer is Connected

Setting External Out Select (2C EXT OUT SEL)

- ① Press the [GLOBAL] button to enter Global mode.
- ② Press the [PAGE+] or [PAGE-] button to select 2A MIDI GLOBAL.
- ③ Press the [▶] button three time to display 2C EXT OUT SEL.
- ④ Use the VALUE slider, [▲/YES] button, and [▼/NO] button to assign the function.

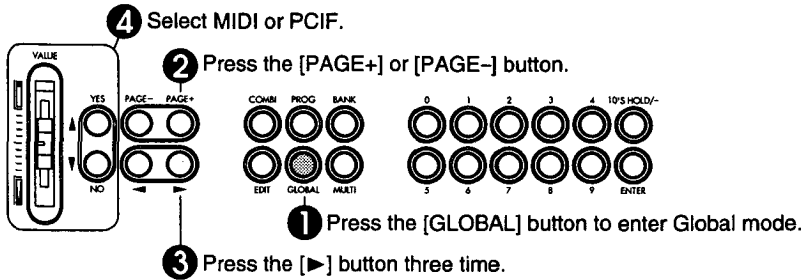

Select "MIDI" to transmit the X5 keyboard data from MIDI OUT, and select "PCIF" to transmit it from TO HOST.

Setting Computer Select (0E PCI/F CLK)

- ① Press the [GLOBAL] button to enter Global mode.
- ② Press the [PAGE+] or [PAGE-] button to select 0A MASTER TUNE.
- ③ Press the [▶] button five time to display 0E PCI/F CLK.
- ④ Use the VALUE slider, [▲/YES] button, and [▼/NO] button to assign the function.

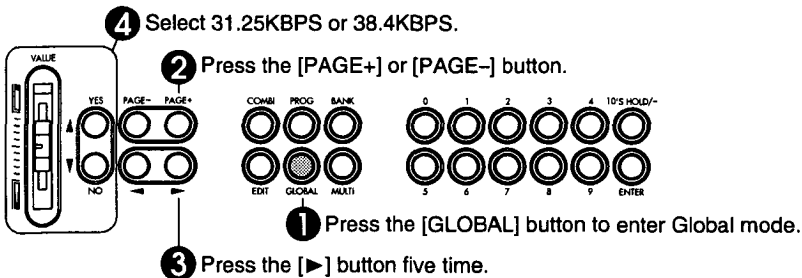

If you connect the X5 to the IBM PC compatible computer, set this parameter to 38.4KBPS. If you connect the X5 to the Apple Macintosh computer, select 31.25KBPS.

Chapter 3: Getting Around the X5

Power On/Off

Power On Procedure

When you have made all the necessary connections, press the power switch to power on the X5. (The power switch is located on the right side on the rear panel.) Then turn on the power to your powered monitor or stereo amplifier.

After you turn on the power to the X5, the LCD screen will display the introduction message for a few seconds. Then the Combination Play mode will be selected.

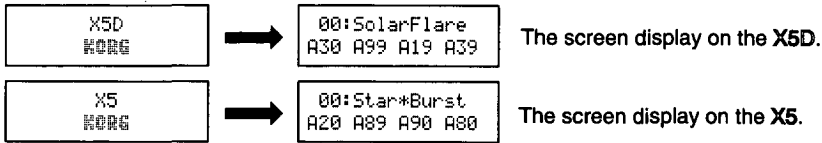

Power Off Procedure

Press the power switch again to turn off the power to the X5.

Do not turn the X5's power off and on when a powered monitor or stereo amplifier is on. Otherwise you may damage the speakers.

Adjusting Volume

Move the MASTER VOLUME slider to set the volume to the optimum level. This slider also adjusts the volume level of the headphones.

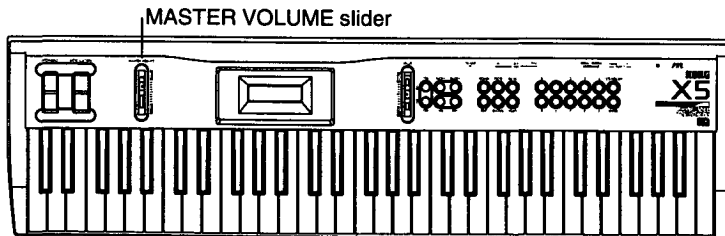

Listening to the Demo Song

The X5 has internal songs that demonstrate the X5's features, and you can play it back on the X5. Listen to and enjoy the wonderful sound, the versatile tone, and the rich expressiveness of the Korg X5.

- 1 Press the [COMBI] button and [EDIT] button simultaneously to enter Demo mode.

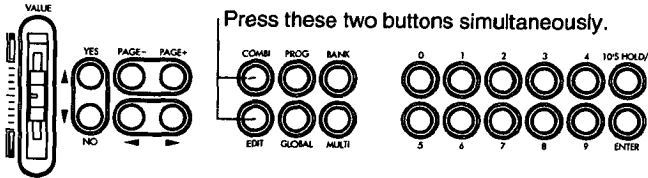

- 2 Press either the [COMBI], [PROG], [GLOBAL], or [MULTI] button to start the demo song.

Playing the Demo Songs on the X5D

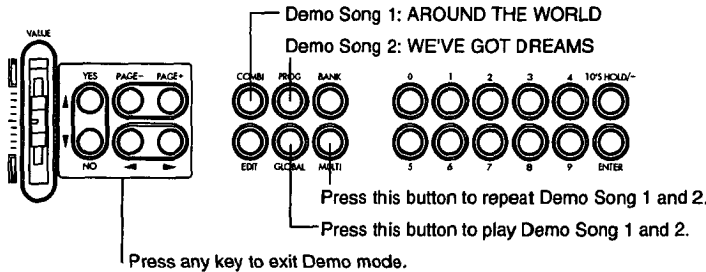

Demo Song 1: AROUND THE WORLD By Stephen Kay

Demo Song 2: WE'VE GOT DREAMS By KORG Inc.

Playing the Demo Songs on the X5

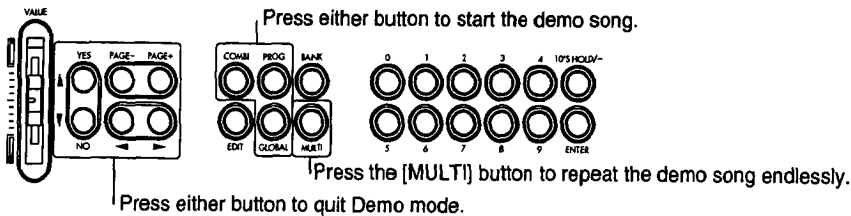

Raise the volume to the optimum level using the MASTER VOLUME control to listen to the demo songs. If you wish to stop the demo song, press any button.

- 3 Press one of the following buttons to quit Demo mode and return to one of the performance modes: [PAGE-], [PAGE+], [◀], [▶], [▲/YES], [▼/NO].

If you hear no sound

Check all the connections. Also, make sure that you have raised the MASTER VOLUME level on the X5 and the volume level of the powered monitor or stereo amplifier.

X5 Modes

There are six operating modes on the X5 for use with different performances, settings, and functions: Program Play, Program Edit, Combination Play, Combination Edit, Multi, and Global.

Program Play

Programs are basic sounds that you can play in Program Play mode. The X5 contains 236 Programs organized in the banks: 100 (A00-99) in RAM (Random Access Memory) where you can store the created or edited sounds, and 136 (G01-136) in the built-in preset area.

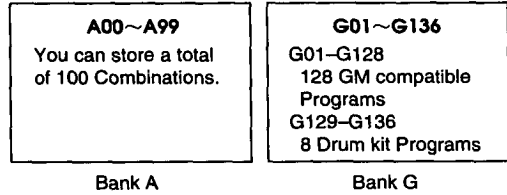

Press the [PROG] button to enter Program Play mode to play Programs.

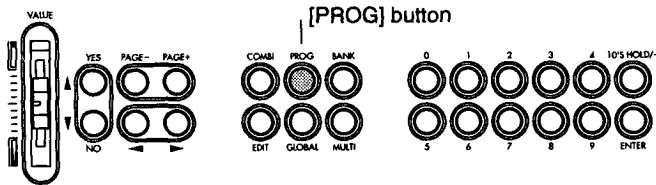

- Refer to "Playing Programs" on page 17 for instructions on playing and switching Programs in Program Play mode.

Program Edit

Program Edit mode allows you to modify the sound of Programs. The figure shows the structure of a Program. You can create your own sound and modify tonal color by modifying these parameters in Program Edit mode.

Press the [EDIT] button while in Program Play mode to enter Program Edit mode.

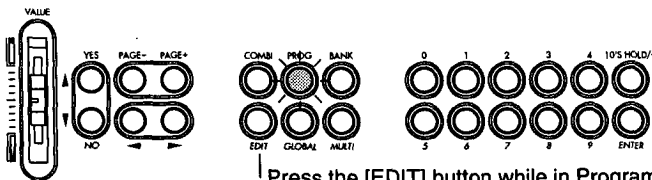
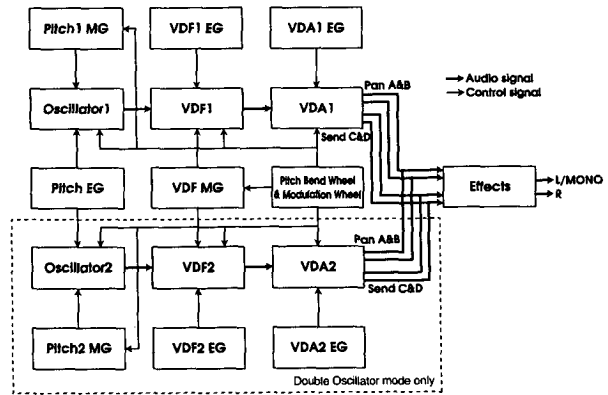

Press the [EDIT] button while in Program Play mode. ([PROG] button blink)

Combination Play

Combinations can use up to eight Timbres. Each Timbre is assigned a Program. You can play Combinations in Combination Play mode. The X5 contains 100 Combinations (00–99).

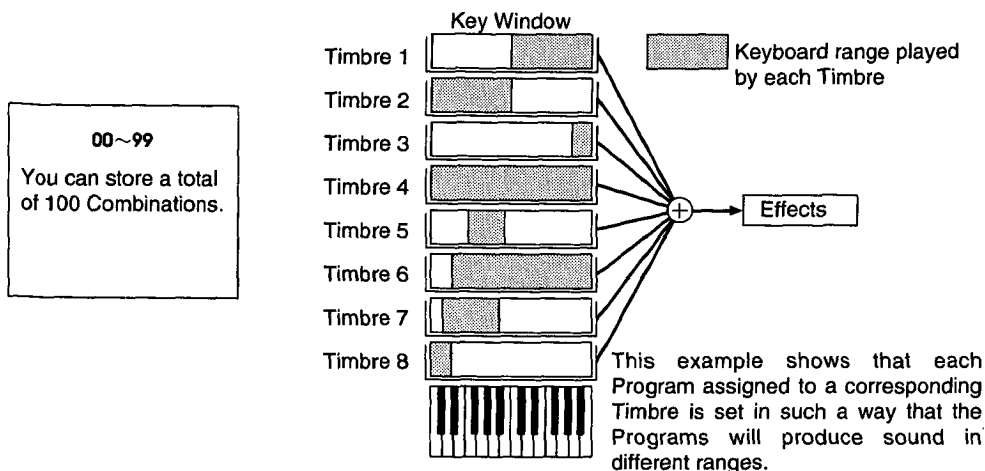

Press the [COMBI] button to enter Combination Play mode to play Combinations.

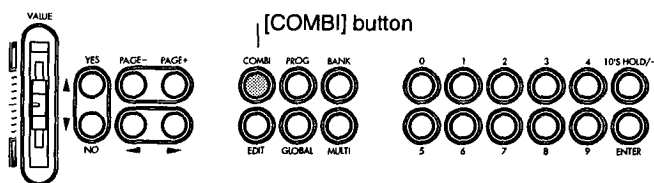

- Refer to “Playing Combinations” on page 22 for information on how to play and switch Combinations in Combination Play mode.

Combination Edit

Combination Edit mode allows you to modify the sound of Combinations. You can create your own sound and modify tonal color by changing the Programs assigned to the Timbres and editing the voicing range of each Timbre.

Press the [EDIT] button while in Combination Play mode to enter Combination Edit mode to edit Combinations.

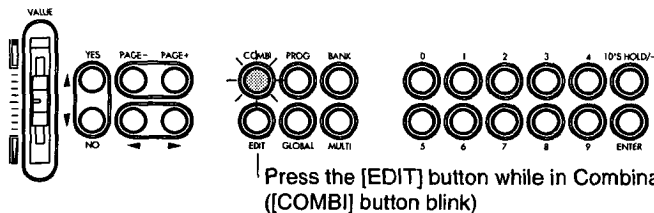

Multi

This mode allows you to use the X5 as a 16-timbre MIDI tone generator that conforms to GM (General MIDI). Enter this mode when you wish to use the X5 as a MIDI tone generator for computer music.

Press the [MULTI] button to enter Multi mode.

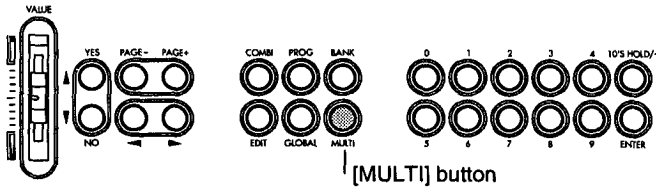

Global

In this mode you can make settings that affect the entire X5 (overall tuning and MIDI-related settings), and assign drum sounds to a Drum kit.

Press the [GLOBAL] button to enter Global mode.

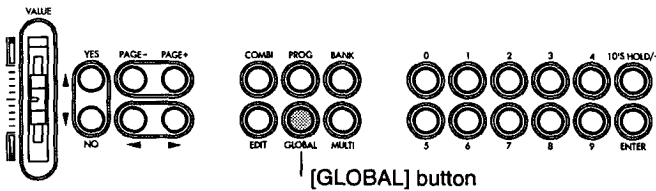

Playing Programs

The X5 has two types of sounds: Programs and Combination. First we will listen to some Programs.

- If you play the sound of the X5 from a sequencer or computer connected via MIDI, or if you play the sound of the X5 from a computer connected by a special cable, refer to the section “When Using MIDI” for information on operations and settings. This explanation does not apply if you are playing the X5 as a stand-alone synthesizer.

Switching to Program Play mode

Press the [PROG] button to enter Program Play mode. This mode enables you to play Programs.

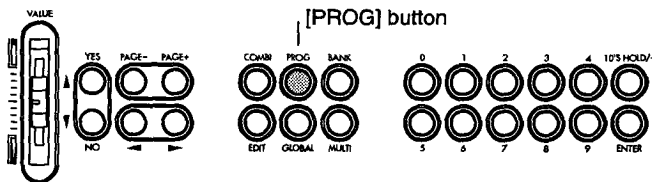

When Program Play mode is entered, the X5 selects the Program that was selected previously in Program Play mode (default setting is A00: PipeDreams on the X5D, and A00:Sunrise on the X5), and the display shows the Program name. Play the keyboard and listen to the sound.



LCD screen in Program Play mode

The display shows the Bank number, Program number, and Program name.

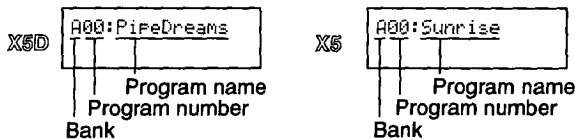

- The Program name “G” for Programs 100–136 (three digit Program number) of Bank G does not appear on the screen.

Selecting Programs

Selecting a Bank

Programs are stored in Bank A and Bank G. Pressing the [BANK] button each time toggles between Bank A and Bank G.

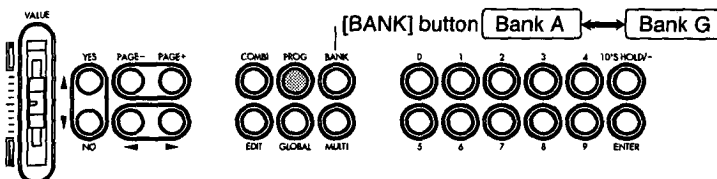

Selecting the Program number

Programs can be selected using the X5 number keypad or the [▲/YES] and [▼/NO] buttons.

To select Programs directly, enter the Program number via the 0–9 number button. Specify a two-digit number to select a Program of Bank A, a three-digit number to select a Program from Programs with a number starting with 0–13 of Bank G, and a two-digit number to select a Program from Programs with subsequent numbers. If you press the [ENTER] button before you finish specifying all the digits, the Program of the current number will be selected.

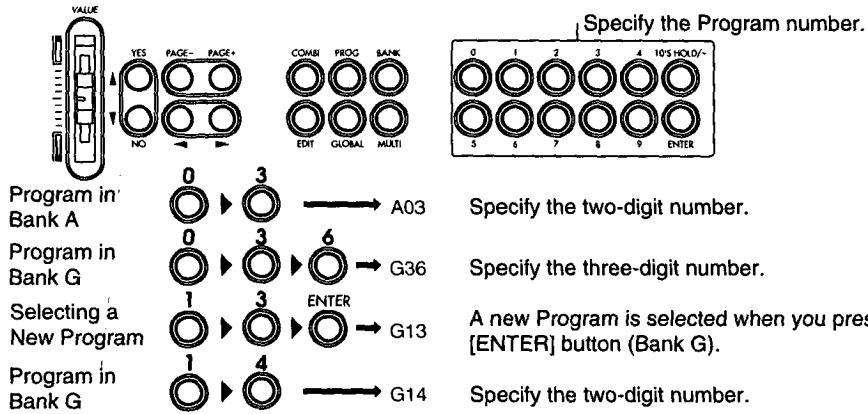

Pressing the [10's HOLD/–] button will lock the second (ten's) digit, and you will be able to change only the first (unit's) digit of the Program number using the number keypad. (In this way, you can switch Programs with a single operation.)

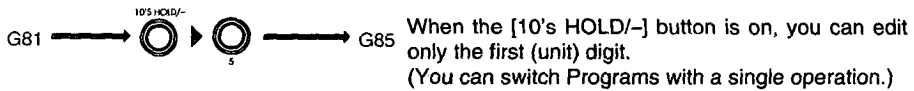

Pressing the [▲/YES] button will change to the next Program, and pressing the [▼/NO] button will revert to the previous Program. When the [10's HOLD/–] button is on, pressing the [▲/YES] and [▼/NO] button changes the second (ten's) digit.

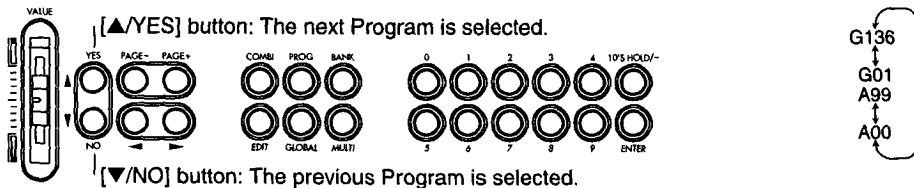

When Using MIDI

Setting MIDI channels

The MIDI channel on a transmission device (sequencer/computer) should match that on the receiving device (X5) to enable the X5 to produce sound via MIDI. The X5 produces sound in Program Play mode when it receives note data on the Global MIDI channel.

- 1 Press the [GLOBAL] button to enter Global mode.

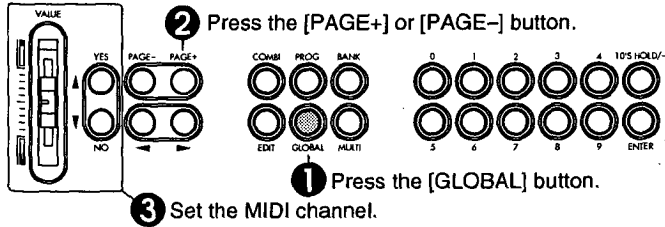

- 2 Press the [PAGE+] or [PAGE-] button to go to 2A MIDI GLOBAL.
 - The parameter currently selected is flashing. At this point, the number of the Global MIDI Channel (CH=) should be flashing.
- 3 Use the VALUE slider, [▲/YES] button, and [▼/NO] button to set the Global MIDI channel.

How to select a Program

Send the Program Change message from the external MIDI device to change Programs.

- The X5 interprets MIDI Program numbers 00–127 as Programs G01–128 in Bank G, and MIDI Program numbers 100–127 as Programs A00–A27 in Bank A.

To change Banks, send Control Change Bank Select (Controller 0/32). The X5 will select a new Program when it receives a Program Change message following a Bank Select message.

Bank Select CTRL#0=0 CTRL#32=0 Bank A (A00–A99)
 Bank Select CTRL#0=56 CTRL#32=any number Bank G (G01–G128)
 Bank Select CTRL#0=62 CTRL#32=any number Drum kit (G129–136)

Program numbers used to select a Drum Program in the Drum Program Bank

Drum Program	Program Number
G129	0
G130	16
G131	25
G132	32
G133	40
G134	64
G135	24
G136	48

Selecting a Program Using a Foot Pedal

You can select a Program using an optional foot switch (PS-1, PS-2) connected to the ASSIGNABLE PEDAL/SWITCH jack. You can assign various functions of the X5 to the foot pedal in 9B ASSIGN SW of Global mode.

- ❶ Press the [GLOBAL] button to enter Global mode.
- ❷ Press the [PAGE+] or [PAGE-] button to select 9A ASSIGN VOL.
- ❸ Press the [▶] button once to display 9B ASSIGN SW.
- ❹ Use the VALUE slider, [▲/YES] button, and [▼/NO] button to assign the function.

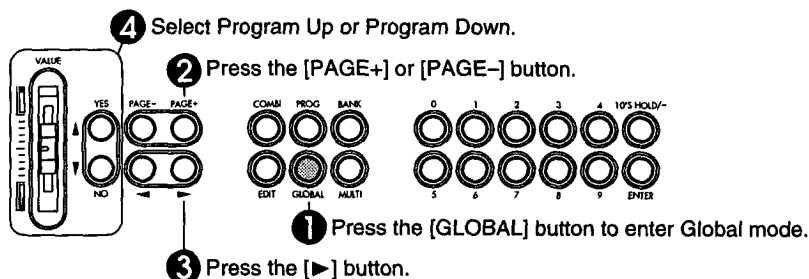

To select a Program using a foot pedal, set the parameter 9B ASSIGN SW in Global mode to Program Up or Program Down.

Program Up: Pressing the foot pedal will increment the Program number by one.

Program Down: Pressing the foot pedal will decrement the Program number by one.

- “Damper” has been selected as a default setting for the foot pedal function. (“Damper” is a pedal that sustains the note, similar to a damper pedal on the piano.) If you wish to use the foot pedal as a damper pedal, set 9B ASSIGN SW to Damper.

When Using MIDI

Playing a Program

To play a Program via MIDI, send the Note data on the Global MIDI channel that was set in 2A MIDI GLOBAL in Global mode. The X5 responds to incoming MIDI notes from C-1 to G9 (MIDI Note numbers 0 to 127, and also to the note data outside the X5’s keyboard range). However, some Programs may not produce any sound at the top end of the range.

About Program numbers

The method used to specify a Program number varies depending on the type of the device being used. You may need to use the numbers 0 to 127 in some cases, and the numbers 1 to 128 in other cases. Or, you may need to use Group - Bank - Program numbers. For some sequencers, it is necessary to create a list of Program numbers and the corresponding Program names to specify a particular Program. Please read your device’s manual before attempting to specifying a Program number.

Program Examples

The X5 has 100 Programs (A00–99) in Bank A and 136 Programs (G01–136) in bank G. Play and listen to a variety of Programs. The following Programs are examples of the X5’s unique Programs, chosen from the built-in 236 Programs. Take a listen to these Programs. X5D has 100 Programs in Pre-a and 100 Programs in Pre-b. These Programs can be loaded using 5A PRESET DATA in Global mode.

X5D has Programs only in Pre-a. Programs in Pre-a are loaded before the unit is shipped from the factory.

A02:BigStrings

This Program recreates the dignified sound of a string section (including violin, viola, and cello). The attack of the sound changes depending on the key velocity. Playing the keyboard softly slows the attack, and playing the keyboard hard will make the attack very fast. With a fast key velocity, it simulates an immediate attack and a bright sound with a subtle touch of bow attack, allowing for a variety of performance expressions through key touch.

A08:Xanalog

This is a brass sound (such as trumpet or trombone) created on an analog synthesizer, generally known as Synth Brass. You will also notice how dynamically the volume level and tonal color of the sound varies depending on the key velocity and key range. This Program is suitable for playing chords. Although the X5D is an all-digital synthesizer, it is also good at old classic analog sounds.

A17:Velo Flute

This Program is a unique sound that simulates the sound of a flute. Play this Program with different key velocities to change the tonal expression. You can also add vibrato effects by sending modulation information.

A84:FeedbackGt

This is a powerful distorted guitar sound (amplifier distortion). As the name suggests, the sound gradually changes to feedback. It sounds a lot like a guitar with a fully-cranked amp. Try some guitar solos using modulation and pitch bend. The Delay effect can also be used to great advantage.

X5D (This is a Program in Pre-b. Load the Program referring to page 156.) and X5

A01: Piano 16'

This acoustic piano sound simulates a real piano, from a powerful low range to a sparkling high range. Notice how the volume level and tonal color of the sound varies depending on key velocity (how strongly you strike the keys). These tonal changes make it possible to reproduce the subtle, dynamic, and expressive range of piano sounds.

A07: The Strings

This Program recreates the sound of a string section, including violin, viola, and cello. Try to play a broad range of the keyboard, including both a dignified low range and a glossy mid-high range. The attack of the sound changes depending on key velocity. Playing the keyboard softly slows the attack, and playing the keyboard hard will make the attack very fast, allowing for a variety of performance expressions through key touch.

A47: AnalogPad

This analog synth Program features a soft and thick sound with a very slow attack and release. This is useful in various music genres.

A50: DreamWorld

This fantastic Program could be used in a movie sound track. The X5 can easily produce this kind of sound effect (as well as the usual instrument sounds).

The Programs described above represent only a few of the X5's Programs. Try several different Programs to enjoy the great sounds of the X5.

About Drum Kits

The following programs use a Drum Kit: A09: KrazyKit and A19: ComboKit (X5D, Pre-a), A09: Total Kit and A69: ProducrKit (X5D Pre-b, and X5), and G129: Kit through G136: Orch Kit.

A Drum Kit is a Program that consists of different drum sounds assigned to each key on the keyboard. Therefore, one Drum kit can play various drum and percussion sounds, instead of playing scales. The X5 has 8 Drum kits in ROM and 2 Drum kits in RAM. To play one of these kits, select it as a Program. (First, set 0A OSC Mode in Program Edit mode to DRUMS, then select a desirable kit for 1A OSC1 SOUND.) (see page 48, 70, and 73.) You can edit the sound key assignments and settings of the Drum Kits in Global mode. (see page 158–160.)

Playing Combinations

Switching to Combination Play Mode

In order to play combinations, press the [COMBI] button to enter Combination Play mode.

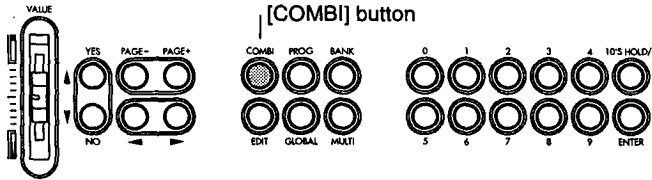

When you enter Combination Play mode, the X5 selects the Combination that was previously selected in Combination mode (the default setting is 00:Star*Burst). The display shows the Combination name. Play the keyboard and listen to the sound.

LCD Screen in Combination Play Mode

The display shows the Combination number and Combination name on the upper line, and the numbers of the Programs used for the Timbres on the lower line. There are eight Timbres. Pressing the [COMBI] button repeatedly will toggle the display between Timbres 1–4 and Timbres 5–8.

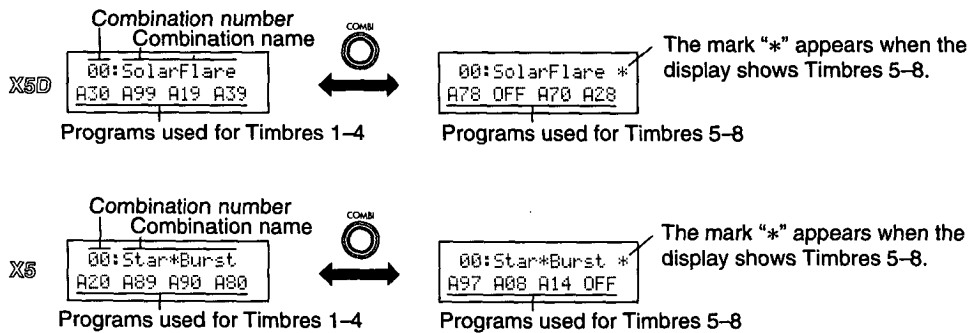

Selecting Combinations

The procedure to select Combinations is the same as for selecting Programs, except that you do not need to select Banks before selecting Combinations. Use the X5 number keypad to specify a two-digit Combination number, or use the [▲/YES] and [▼/NO] buttons.

- Refer to “Selecting Programs” on page 17 for information about how to use the number keypad and [▲/YES] and [▼/NO] buttons.

To select a Program using a foot pedal, set the parameter 9B ASSIGN SW in Global mode (see page 161) to Program Up or Program Down.

Playing Combinations

Combinations can consist of up to eight Programs assigned to eight Timbres. The Timbres can be assigned to different MIDI Channels, so each Timbre will respond only to MIDI Note data on its assigned MIDI Channel. Playing the X5 keyboard will produce the sound of the Timbre of the Global MIDI Channel. Initially, all Timbres are assigned to MIDI Channel 1. So you need to set the Global MIDI Channel to 1 if you wish to play the X5 keyboard. If the Global MIDI Channel has been changed to any number other than 1, set it to 1. Refer to “Setting MIDI channels” on page 19 for information about how to set the Global MIDI Channel.

- If the Global MIDI Channel has not been changed, you do not need to edit the setting since the Global MIDI Channel is initially set to 1.

Combination Types

You can combine various Programs by editing the Timbre settings in Combinations. For example, you can play a different Program with each hand, or you can play different Programs by applying a different key touch on the keyboard. These techniques are very useful and powerful in live performance. Timbre settings that determine the combination of Programs are made in Combination Edit mode. (see “Editing Combinations” on page 46.) Let’s take a look at the various types of Combinations that are available.

Layer

The X5 produces the sound of multiple Programs simultaneously. When Timbres are layered together, they produce a thick and complex Combination, such as a piano sound overlapped with a strings sound.

Split

Timbres can be set to produce the sound of a different Program depending on the range on the keyboard. For example, you can play a piano sound in the higher range of the keyboard using your right hand, and play the bass sound in the lower range of the keyboard using your left hand.

VSw (Velocity Switch)

Timbres can be set to respond to a specific key velocity (how firmly you strike the keys). For example, you can set Timbres in such a way that a strings sound is produced when you play the keyboard softly, and a brass sound is produced when you play the keyboard hard.

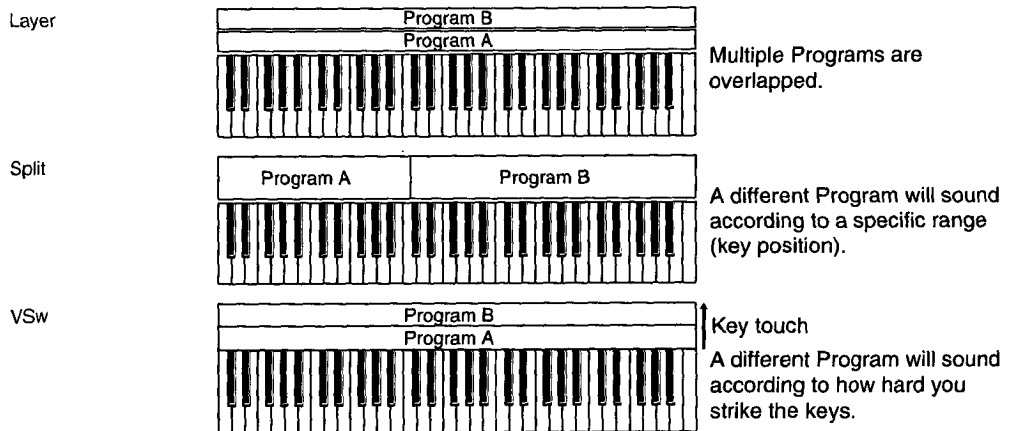

The examples here are all based on the use of two Programs. Since the X5 allows you to use up to eight Timbres, you can combine these types to create more sophisticated settings.

When Using MIDI

Playing Combinations

The Timbres in Combinations can be assigned to different MIDI Channels. To play the X5 via MIDI, set the MIDI receive channel of each Timbre so that it matches the MIDI channel of the transmission device (see page 96). Initially, all Timbres are assigned to MIDI Channel 1. You must therefore set the MIDI channel of the transmission device to 1.

Selecting Combinations

Combinations can also be selected using a MIDI Program Change message on the Global MIDI Channel in Combination Play mode. You can change Programs assigned to each Timbre through the MIDI channel specified for each Timbre. (Refer to “Selecting Programs” on page 17 for information about changing Programs.)

- If the Global MIDI Channel and the MIDI channel of a Timbre are the same, changes in Combinations will have priority.
- When changing Combinations, the X5 will interpret Program Change numbers 100–127 as Combination numbers 00–27.

Combination/Program Change Filter

2D MIDI FILTER in Global mode determines how the X5 receives MIDI Program Change messages. When “DIS” or “PRG” is selected, MIDI Program Change messages do not change Combinations. When “ENA” is selected, MIDI Program Change messages received on the Global MIDI Channel select Combinations in Combination mode. You can also change Programs assigned to Timbres in Combinations. (see page 153.)

You can also set the MIDI filter for MIDI Program Change messages for each Timbre in Combination Play mode. (see page 100.)

MIDI Transmission in Combination Play Mode

The keyboard, pitch bend wheel, and modulation wheel data in Combination Play mode is sent on the Global MIDI Channel. All Note data from the keyboard performance is sent via MIDI, regardless of the ranges of the keyboard and the velocity that are specified for the Timbres in a Combination.

- You can select MIDI OUT or TO HOST for the keyboard data output in 2C EXT OUT SEL in Global mode. (see page 153.)

Combination Examples

The X5 has 100 Combinations (00–99). Play and listen to a variety of Combinations. The following are some examples of the X5's unique Combinations. Take a listen to these Combinations. X5D has 100 Combinations in Pre-a and 100 Combinations in Pre-b. These Combinations can be loaded using 5A PRESET DATA in Global mode.

X5D has Combinations only in Pre-a. Combinations in Pre-a are loaded before the unit is shipped from the factory.

12:Wind→Orch

This orchestra sound combines woodwind, strings, and timpani sounds. With a low key velocity, the woodwind sound is produced, and with a high key velocity, a strings sound is produced. This allows you to play two different sounds by switching the key velocity. In the low range, the timpani sound and cymbal sound are produced only when you play the key with a high key velocity. In this way, Combinations allow you to play different Programs easily, depending only on the key range and key touch.

49:RapToolKit

This Combination consists of drum, bass, guitar, and effect sounds. You can play the drum sound with the left hand, while playing the bass or guitar sound with the right hand. In the mid range, the tonal color changes depending on the key velocity. With a low key velocity, a bass sound is produced. With a high key velocity, a guitar sound is added. The scratch sound and orchestra hit sound are assigned to the higher range.

X5D (This is a Combination in Pre-b. Load the Combination referring to page 156.) and X5

00: Star*Burst

This Combination combines various sounds to produce a thick, heavy sound. You can create this kind of thick sound by combining multiple Programs. This Combination uses keyboard split and velocity switches. Check to see that the sound is different on either side of the Middle C on the keyboard. In the low range, a different Program sounds according to key touch. When you play the key softly, the sweep sound is not produced; when you play the key hard, the sweep sound is produced with a delay.

11: Bass&Piano

The Bass Program is assigned to the lower range (Center B or lower), and the Piano Program is assigned to the higher range (Middle C or higher). You can play the bass phrase with the left hand, while playing the backing piano part with the right hand. This type of split Combination allows you to play two parts simultaneously in live performance.

39: HouseParty

This is a split Combination with a different Program assigned to each range. A Drum Kit is assigned to the lower two octaves; above them the bass Program is assigned to the range of 1.5 octaves; and the brass Program is assigned to the higher range. The X5 can treat a Drum Kit as a Program. You can thus play phrases with some Programs while playing the drum sounds.

The Combinations described above are only part of a variety of Combinations the X5 has to offer. Try playing different Combinations to enjoy the great sound of X5.

Performance Technique (Performance Function)

Now you know what Programs and Combinations are. You can add rich expression to these sounds using various performance techniques. Although playing the piano sound on the keyboard simulates a real piano sound, using a foot pedal will add the effect of a damper pedal. For a guitar sound or brass instrument sound, you may use the pitch bend wheel and the modulation wheel to control pitch and produce vibrato effect respectively. This technique, which is used to add expression to your performance, is called “Performance Function”.

Keyboard Velocity

How hard you play the keyboard affects the expressiveness of the sound. You can adjust the volume level setting so that playing the keyboard softly will produce a soft sound, and playing hard will produce a loud sound. In addition, you can also adjust the brightness of the sound and the envelope settings such as attack rate and release time. Using Velocity Switch in Combination Play mode and Multi mode, you can play different Programs by changing the keyboard velocity.

- See page 83–85 for information on how to change the volume level and envelope using key velocity.
- See page 78–80 for information on how to change the brightness and tonal color of the sound using key velocity.
- See page 74 for information on how to control the pitch change using key velocity.

Pitch Bend/Modulation Wheel

The pitch bend wheel and modulation wheels located on the upper left of the keyboard allow you to control the pitch and the depth of modulation. The modulation wheel can be used to adjust the depth of the wah effect and After Touch, as well as the depth of vibrato. Go to 10A MG WHEEL in Global mode (see page 162) to set the modulation wheel function.

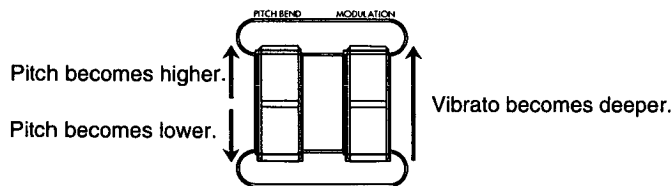

- See page 91 for information on how to change the pitch bend range of the pitch bend wheel.
- See page 91 for information on how to change the cutoff range of the pitch bend wheel.
- See page 88 for information on how to change the depth of vibrato using the modulation wheel.
- See page 90 for information on how to change the depth of the wah using the modulation wheel.
- See page 91 for information on how to set the After Touch using the modulation wheel.

Assignable Pedal/Switch

Connecting an optional volume pedal (such as EXP-2, XVP-10) to the ASSIGNABLE PEDAL, or a foot pedal (such as PS-1/2) to the ASSIGNABLE SWITCH connector, allows you to adjust the volume level, brightness, and effect settings. The function of the assignable pedal is set by 9A Assignable Pedal and 9B Assignable Switch in Global mode.

- See page 161 for information on setting the assignable pedal function.
- See page 161 for information on setting the assignable switch function.

Effect Dynamic Modulation

Effect Dynamic Modulation is a function that controls the effect level balance and modulation rate. Controlling the effect parameters using the modulation wheel, volume pedal, and VDA EG allows for real-time effect adjustment during performance.

- See page 114 for information on adjusting real-time effect parameters.

After Touch

While you are playing the keyboard, pressing the keys hard will control tonal brightness or modulation.

- The X5 does not have an After Touch sensitive keyboard. However, you can apply After Touch effect using the modulation wheel or sending After Touch messages from an external sequencer. Use 10A MG Wheel in Global mode to make the modulation wheel settings.
- See page 86 for adjusting the depth of vibrato using After Touch.
- See page 90 for information on adjusting the depth of wah using After Touch.
- See page 90 for information on adjusting pitch using After Touch.
- See page 90 for information on adjusting the brightness of the sound using After Touch.
- See page 90 for information on adjusting the volume level using After Touch.

When Using MIDI

Controlling the Performance Function via MIDI

Send the following MIDI data to the X5 when you wish to control the performance function via MIDI.

Keyboard Velocity

Keyboard velocity corresponds to the MIDI Note On Velocity. The velocity value controls the volume level of the sound.

Pitch Bend/Modulation Wheel

Pitch Bend data controls the effects of the pitch bend wheel. Control Change data controls the effects of the modulation wheel. Send MIDI Controller 1 for vibrato effect (pitch modulation), send MIDI Controller 2 for wah (VDF modulation), and send After Touch data for After Touch effects.

Assignable Pedal/Switch

The assignable pedal/switch functions can also be controlled by MIDI data. Send Control Change message Controller 7 (CTRL#7) for volume, CTRL#11 for expression, CTRL#74 for VDF cut off, and CTRL#12/13 for effect control 1/2 for the assignable pedal function, and CTRL#64 for damper, CTRL#92 for effect 1 on/off, and CTRL#94 for effect 2 on/off for the assignable switch function. Use Program Change message and Bank Select message for Program up/down.

After Touch

The After Touch data (Channel Pressure) controls After Touch. The X5 will not receive Polyphonic Key Pressure (After Touch for each key).

Performance in Multi Mode

Multi mode allows you to use the X5 as a 16-channel multi-timbre (GM) tone generator. The X5 will play the tracks whose channels match the Global MIDI Channel, as in Combination Play mode. Multi mode is generally used to control the X5 from an external sequencer or computer.

Refer to “When Using MIDI” on page 33” for information about how to control the X5 via MIDI from the external sequencer.

Selecting Multi Mode

Press the [MULTI] button to enter Multi mode.

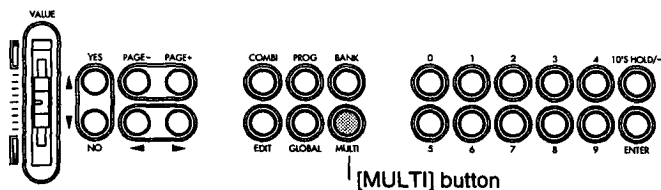

In this mode, you can play the track data on the Global MIDI Channel from the keyboard. Since the default setting of the MIDI Channels of Tracks 1-16 are 1-16, and the Global MIDI Channel is 1, only Track 1 will be played back.

LCD Screen in Multi Mode

In Multi mode, the LCD screen shows the track parameters and other function settings. Use the [PAGE+] and [PAGE-] buttons to move to another page (up/down), and the [◀] button and [▶] button to select a parameter (left/right). While the track parameters are shown on the screen, using the [PAGE+] or [PAGE-] button will change the screen to show the same parameters for the next or previous track.

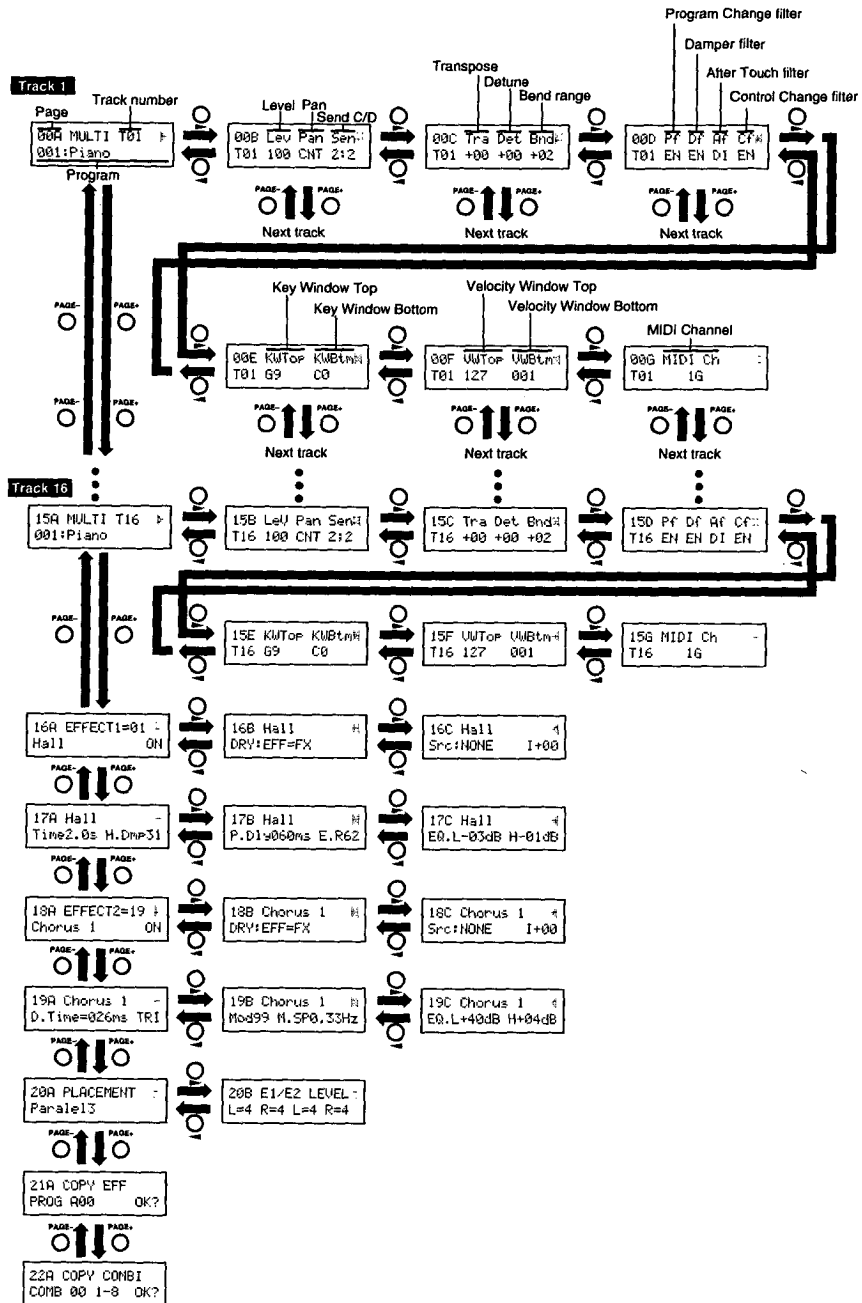

- On pages 00–15 you can specify and set Programs for Tracks 1–16. On page 16 and the following pages, you can set various parameters for effects and execute copy operations. The content of the pages may vary depending on the effect settings.

Structure of Multi Mode

Multi mode allows you to use the X5 as a GM tone generator which conforms to General MIDI System Level 1.

When GM ON messages are received, when 23A SET TO GM is executed, or when the power is turned on, the GM settings are automatically selected, and MIDI Channels for Tracks 1–16 will become 1–16 respectively. Track 10 (MIDI Channel 10) is used for a rhythm part, and the default setting is G129: GM Kit. Other tracks are assigned G01: Piano. Refer to page 32 for details.

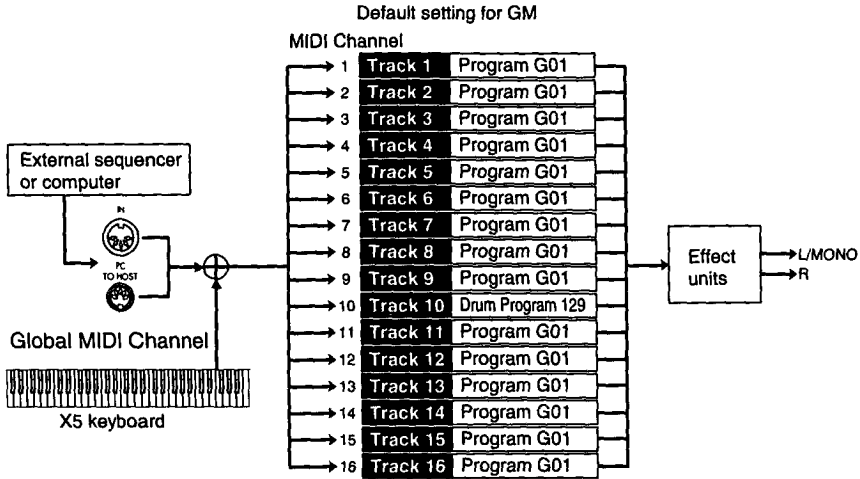

Selecting a Program for Tracks

You can select a Program for each Track in Multi mode on the X5 as well as using MIDI data from an external sequencer or computer.

- ❶ Select a track for which you wish to change a Program, using the [PAGE+] and [PAGE-] buttons to go to page *A. Programs for Tracks 1–16 are shown on pages 0A–15A.
- ❷ Use the VALUE slider or [▲/YES] and [▼/NO] buttons to select a Program. You can also use the number keypad to specify the Program number directly.

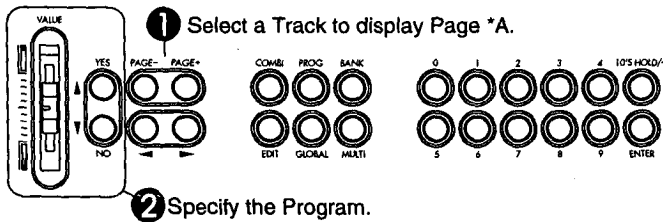

In a similar way, set the Track parameters: volume level (Lev), send C/D (Sen), transpose (Tra), detune (Det), bend range (Bnd), Program Change filter (Pf), Damper filter (Df), After Touch filter (Af), Control Change filter (Cf), Key Window (KWTop/KWBtm), Velocity Window (VWTop/VWBtm), and MIDI Channel (MIDI Ch).

You can copy these settings from Combinations. (see page 111.)

When GM ON messages are received, when 23A SET TO GM is executed, or when the power is turned on, these settings are automatically reset to the GM default settings.

You can also store these settings to an external MIDI data filter using MIDI Data Dump. (see page 155.)

Refer to “When Using MIDI” for information about how to control the X5 in Multi mode from an external sequencer or computer via MIDI.

When Using MIDI

Playing the X5 in Multi Mode

Multi mode enables the X5 to function as a MIDI tone generator that is controlled from the connected computer to play ensemble music consisting of multiple instrument parts. This mode permits you to use the X5 as a GM tone generator.

- You can copy the parameter settings of Combinations into Multi mode for performance. Refer to page 111 for details.

Default Settings in Multi Mode

The following table shows the default settings for Multi mode that are automatically selected when the power is turned on to the X5, when 23A SET TO GM is executed, or when the X5 receives a GM ON messages (F0 7E 7F 09 01 F7).

	Track1-9, 11-16	Track 10	
Program	G01: Piano (for all Tracks)	G129: GM Kit	*Can be controlled via MIDI
Level	127 (for all Tracks)	127	
Panpot	CNT (for all Tracks)	PRG	*Can be controlled via MIDI
Send C	2 (for all Tracks)	P	*Can be controlled via MIDI
Send D	2 (for all Tracks)	0	*Can be controlled via MIDI
Transpose	0 (for all Tracks)	0	*Can be controlled via MIDI
Detune	0 (for all Tracks)	0	*Can be controlled via MIDI
Pitch Bend Range	+2 (for all Tracks)	0	*Can be controlled via MIDI
Program Change Filter	ENA (for all Tracks)	ENA	
Damper Pedal Filter	ENA (for all Tracks)	ENA	
After Touch Filter	ENA (for all Tracks)	ENA	
Control Change Filter	ENA (for all Tracks)	ENA	
Key Window	C-1-G9 (for all Tracks)	C-1-G9	
Velocity Window	001-127 (for all Tracks)	001-127	
Effect	----	----	NUM* for PROG, DIS for EX, ENA for others
MIDI Channel	1-9, 11-16 (Corresponding to the Track number)	10	

About Program

Sending the Bank Select and Program Change messages will select a Program for each Track. (Refer to page 17, 106)

About Level

Send the Control Change Volume data (CTRL#7) or the Expression data (CTRL#11) to change the volume level of each Track.

- The Level parameter does not respond to the MIDI Control Change messages.

About Panpot

Send the Control Change Panpot data (CTRL#10) to change the panpot setting for each Track. Track 10 will ignore the Panpot data since panpot has been used for each index in a Drum Kit as a default setting (PRG). However, if the panpot setting for Track 10 is set to any value other than "PROG", this Track will respond to the received Panpot data (that is, the panpot settings for all instruments in the Drum Kit becomes the same). (See page 107)

About Send C/D

Send the Control Change Effect Depth data (CTRL#91/93) to change the Send C/D settings for each Track. Track 10 will ignore CTRL#91/93 since Send C/D has been used for each index in a Drum Kit as a default setting ("P"). However, if the Send C/D setting for Track 10 is set to any value other than "P", this Track will respond to the received Send C/D data (that is, the Send C/D setting for all the instruments in the Drum Kit becomes the same).

About Transpose, Detune, and Pitch Bend Range

You can change these settings for each Track using RPN. Specify the parameter you wish to edit using RPN, then set the value using the Data Entry controller (CTRL#6 or #38).

Notes for Playing Back GM Songs

Before playing back performance data (GM song) for a GM tone generator, make sure that the following settings have been made in Global mode for correct playback.

0B	Key Transpose	+00
0D	Velocity Curve	3
	After Touch Curve	3
1A	Scale Type	Equal Temp
2A	Note Receive	ALL
2C-2D	MIDI Filter	PRG=NUM, EX=DIS, ENA

- See page 153 for the function of each parameter.

Set all the parameters in Multi mode to their default setting as shown on the previous page. (Receiving the GM ON messages will restore the default settings.)

Some GM songs may include non-GM MIDI data. In particular, Program Change messages may be interpreted as Bank select messages (for Bank A) when you are playing back a GM song that uses Bank Select messages. When you play back GM songs (not X5 performance data), set PRG of MIDI filter in Global mode to "NUM" to ignore the Bank Select messages. If you are playing only the X5 (to create X5 performance data), set this PRG parameter to "ENA" to use GM compatible Programs in Bank G or your original Programs stored in Bank A. Use a setting appropriate to the type of data you are going to create or play back.

When Using MIDI

Using the X5 as a MIDI keyboard

The X5 keyboard data will be output from either MIDI OUT or TO HOST. When using the MIDI OUT connector, set 2C EXT OUT SEL of Global mode to "MIDI", and when you wish to output the data to the computer, set it to "PCIF". (see page 153.)

To use the X5 as a MIDI keyboard from which you input MIDI performance data, set the sequencer's echo back to ON so that you will be able to listen to the sound while you are playing the keyboard. In this case, both the Note data sent from the keyboard to the tone generator, and the note data sent from the keyboard through the sequencer to the tone generator, will produce the sound. Therefore, it is necessary to disconnect the keyboard from the tone generator by setting 2B Local Control of Global mode to OFF. You can also achieve this Local Off setting by sending the Local Off message (*CTRL#122) from the sequencer.

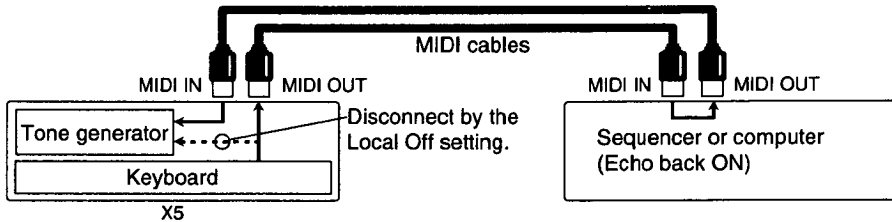

- When the Local Off is set, you cannot play the X5 as a stand-alone synthesizer. (However, the data input on the keyboard will be sent to MIDI OUT or TO HOST, and the tone generator will produce sound responding to the data from MIDI IN or TO HOST.) If you play only the X5, select Local On.

Keyboard data transmission via MIDI

The keyboard, pitch bend wheel, and modulation wheel data will be sent on the Global MIDI Channel from MIDI OUT or TO HOST. If you wish to change the MIDI transmission channel, change the setting of the Global MIDI Channel.

- 1 Press the [GLOBAL] button to enter Global mode.
- 2 Press the [PAGE+] or [PAGE-] button to select page 2A MIDI GLOBAL.
- 3 Use the VALUE slider, or the [▲/YES] and [▼/NO] buttons to set the Global MIDI Channel (CH=).

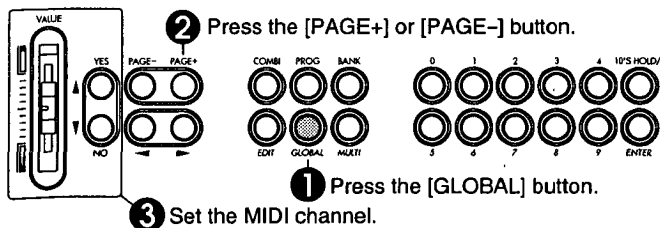

If you play the X5 keyboard, or if the sequencer echo back is ON, the Timbres of the Track of the channel that matches the Global MIDI channel will produce sound. However, if Key Window or Velocity Window has been set, only the Note data of the range specified for the Track will sound. The value of Note Number and Note Velocity varies depending on the Transpose and Velocity Curve positions described below.

About Transpose and Velocity Curve

0C Trans Position in Global mode allows you to set the position where the transpose (0B Key Transpose) and velocity curve (0D Velocity Curve) become effective.

AfterKBD

Keyboard data is sent through Transpose and Velocity Curve to the tone generator and the MIDI OUT or TO HOST connector. Incoming data received at MIDI IN or TO HOST will be sent to the tone generator. (The Transpose and Velocity Curve settings do not affect the data received at MIDI IN/TO HOST.)

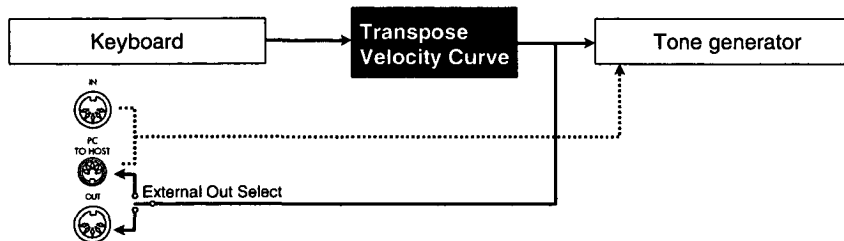

BeforeTG

Keyboard data and incoming data received at MIDI IN/TO HOST will be sent through Transpose and Velocity Curve to the tone generator. The keyboard data will be output from MIDI OUT/TO HOST as it is. (The Transpose and Velocity Curve settings affect the data when the keyboard controls the tone generator, but they do not affect the data sent to the MIDI OUT/TO HOST connectors.)

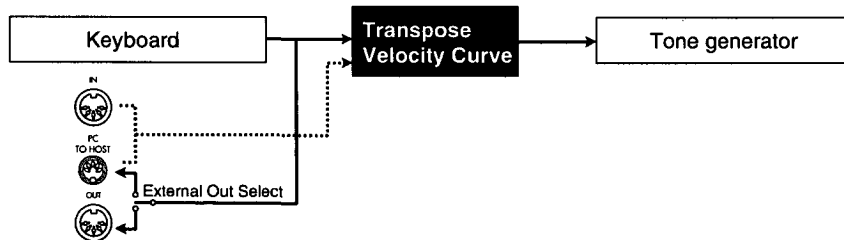

Chapter 4: Editing

Basic Concepts

Although you can perform a wide variety of music using the preset Programs and Combinations that the X5 offers, you should not limit your creativity by relying on the presets alone. You can modify a preset sound. (This operation is called “editing”.) You can also create sounds from scratch.

The X5 is not only a tone generator that provides various factory-set sounds, but also a synthesizer that employs Korg’s powerful AI Square Synthesis, which allows you to create new, original sounds or to edit existing sounds. Take a moment to try out the sound editing capabilities of the X5.

Sound Structure

The X5 can produce a variety of sounds, such as piano, guitar, drums, percussion, synthesizer, special effects, etc. In order to modify these sounds or to create new sounds, you need to tell the X5 how you wish to change the sound using parameters. You can edit sound by modifying parameters in Program Edit mode and Combination Edit mode.

For smooth editing operations, it is helpful to understand what sound consists of. Musical sound consists of three main components: pitch, tone, and volume. In a tone generator, each of these components has its own corresponding building block. In the X5, pitch is handled by the OSC (oscillator) block, tone by the VDF (Variable Digital Filter) block, and volume by the VDA (Variable Digital Amplifier) block. The following illustration shows the three blocks.

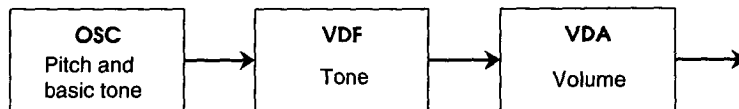

Pitch: OSC (oscillator)

The basic tonal quality of an X5 sound is determined by the waveform (Multisound) that you assign to an oscillator. The X5 contains a great variety of Multisounds to simulate different sounds, from the piano sound to synth sounds. The first step in creating a new sound is to select a Multisound.

Tone: VDF (filter)

The VDF allows you to adjust the brightness of a sound. A Multisound assigned to the OSC contains various harmonics and frequency components that characterize the tonal quality of the sound (such as a piano or guitar sound). The VDF employs a low pass filter to filter high frequency components from a Multisound in order to adjust the brightness of a sound. Typically, the more frequency components that are filtered, the darker (softer) a sound will become.

Just like a real musical instrument, you can change the tonal quality of a Multisound over time. You do this by adjusting the amount of filtered components (brightness) using the VDF EG. For example, you can make a sound that is bright at the start but gradually becomes darker over time.

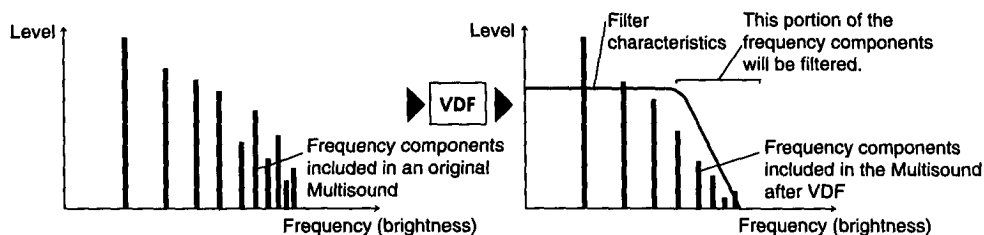

Volume: VDA (amplifier)

The VDA allows you to adjust volume. The “volume” referenced here is not the volume of the entire performance, but the volume changes within a sound. For example, the piano sound volume starts with a high attack level, then drops gradually. The organ sound volume does not change until you release the key, while the violin volume varies depending on a performance technique. The VDA allows you to edit the volume changes.

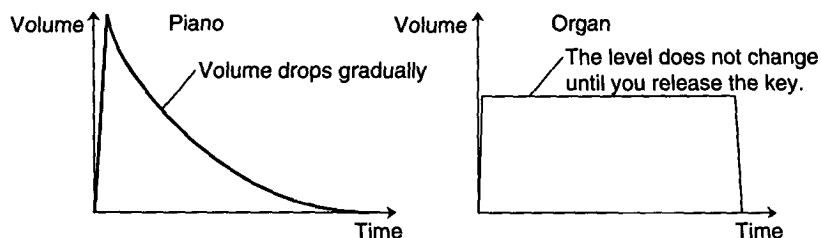

EG and MG

The X5 provides EG (Envelope Generator) and MG (Modulation Generator), which are used to add changes over time (or in cycles) to the pitch, tone, and volume.

EG

This allows you to add changes over time to a sound. The X5 has Pitch EG, VDF EG, and VDA EG, which are available for editing pitch, tone, and volume respectively. For example, the VDA EG will determine how the volume specified by the VDA changes over time.

MG

This allows you to add cyclical changes to the sound. The X5 utilizes Pitch MG and VDF MG, which are available for editing pitch and tone. The Pitch MG allows you to add cyclical changes in pitch (vibrato or pitch modulation); VDF MG will add cyclical changes in tone (wah or VDF Cutoff modulation).

Editing on the X5D

The following section explains how to edit sound, using a sound in Preset b. First, load PRE-b before editing. (See page 156). On the X5, you will use the preset data.

Editing Programs

This section is a Program Edit tutorial. Here we will not save the edit in memory. To save the edited Program, you need to carry out the Program Write operation.

- If you do not save the edited Program (using the Program Write operation), the content of the existing Program will not be changed. (Refer to page 61 for information on the Program Write operation.)

Adjusting the Attack of Programs

Let's use Program A01: Piano 16' to edit the speed at which the attack part of the sound reaches its peak.

- 1 Select Program A01: Piano 16' in Program Play mode.
- 2 Press the [EDIT] button to enter Program Edit mode.
Before editing a Program in Program Edit mode, you need to select a Program you wish to edit in Program Play mode.
- 3 Press the [PAGE+] or [PAGE-] button to select 5A VDA1 EG on the screen.
 - Program A01: Piano 16' is a Single mode Program. If you have selected a Double mode Program, which has more display pages, page 8A will be selected.
- 4 Press the [◀] and [▶] cursor buttons to select AT. (Usually, the cursor is already located on the AT parameter.)
 - The AT parameter is used to set the attack time. (see page 82.)
- 5 Use the VALUE slider or the [▲/YES] and [▼/NO] buttons to set the AT value.

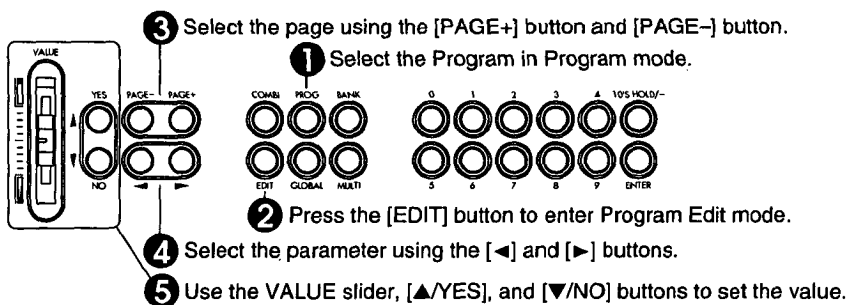

Play the keyboard and listen to the sound while changing the AT value. A higher value will produce a slower attack. When it reaches about 50, the piano Program starts to sound more like a cello. Only editing the attack time can change the sound characteristics.

Now set the AT parameter back to 00.

In this way, you can edit the parameters in Program Edit mode using [PAGE+] and [PAGE-] buttons to select a page, [◀] and [▶] buttons to select a parameter, and the [▲/YES] and [▼/NO] buttons to set the value.

Undo

After changing the parameter value in Program Edit mode, pressing the [▲/YES] and [▼/NO] buttons simultaneously restores the value originally set for the parameter. This operation is called the “Undo” function, and is useful when you forget the original value. This undo function can be used for parameters in other modes.

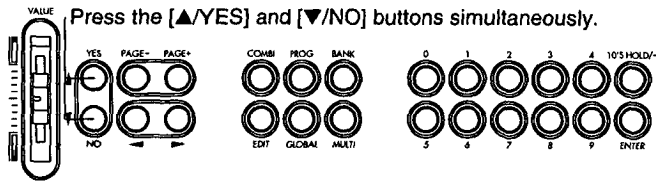

Adjusting the Decay

The volume level of Program A01: Piano 16' is gradually decreased even if you continue holding down the key. This decay portion is set by DT (Decay Time) on page 5A VDA1 EG, and BP (Break Point) and ST (Slope Time) on page 5B VDA1 EG.

After adjusting the attack, page 5A VDA1 EG is shown. Use the [◀] and [▶] buttons.

The following diagram shows what is specified by the VDA EG parameters.

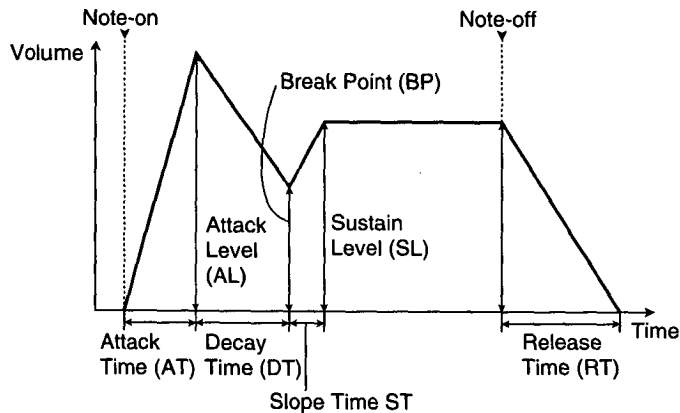

The following diagram shows the VDA EG of Program A01:Piano 16'.

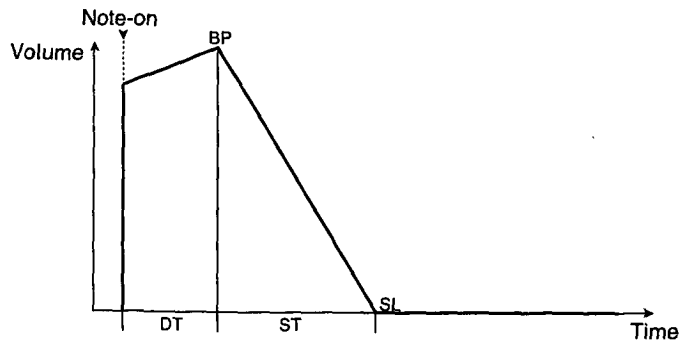

This setting looks different from those for a piano sound with a fast attack and a gradual decay. This is because its Multisound (see page 42) contains a very sharp attack. (The DT setting in this VDA EG suppresses a sharp attack of the Multisound.)

You can set the decay time using the ST (Slope Time) parameter for Program A01: Piano 16'. A small value for the DT (Decay Time) will make the ST effect more obvious. Try out different settings and listen to how the sound changes. If you raise the SL (Sustain Level) from 00 (which is often used for the piano sound Programs), the sound will remain at a certain level as long as you are pressing and holding down the key.

After checking the sound, reset the parameters to the default settings of the VDA1 EG as follows: AT=00, AL=87, DT=64, BP=98, ST=89, SL=00, and RT=39.

Adjusting the Release

The release part of sound that you can hear after you release the key will be adjusted by the RT (Release Time) parameter on page 5C VDA1 EG.

The default release time setting for Program A01: Piano 16' is set to 39. Change this value and listen to the sound. With a lower value, the sound will decay quickly after you release a key; with a higher value, the release will take longer.

- If you set this parameter too high, the sound will continue for a very long time. In this case, return to Program Play mode and select the same Program again. (All the parameters will be reset to the default settings.)

The SL (Sustain Level) setting of the VDA EG for the current Program is set to 00. This means the sound will decay regardless of the RT setting if you continue playing the keyboard. However, if you release the keys during the DT or ST part, you will hear the release sound defined by the RT setting.

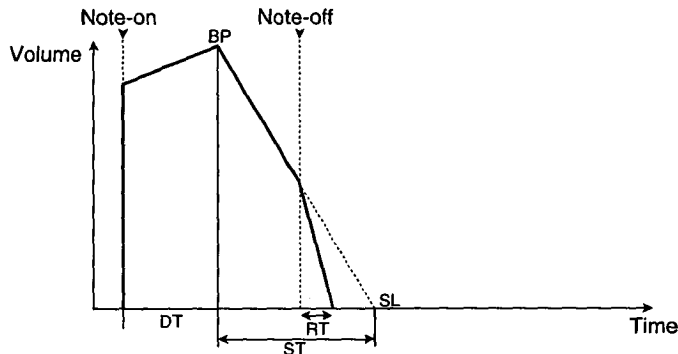

Adjusting the Tonal Brightness

You can use the VDF to adjust the tonal brightness. This technique is very useful when you want to change a nuance of the tone, or when you have noticed that a certain Program is too striking or too quiet while you are playing multiple Programs in Combination Play mode. Adjusting tonal brightness will allow you to layer multiple Programs evenly and to bring the ensemble together.

For example, let's adjust the brightness of Program A68: Soft Horns. Select this Program in Program Play mode, and enter Program Edit mode.

Press the [PAGE+] button three times to display the first page of 3A VDF. Changing the Fc (cutoff frequency) will change brightness. Low Fc values makes the sound darker, while higher values make it brighter.

The Fc (cutoff frequency) sets the frequency above which frequencies will be filtered. Therefore, low Fc values cause more frequency components to be filtered, resulting in a darker sound. High Fc values cause less frequency components to be filtered, resulting in a brighter sound.

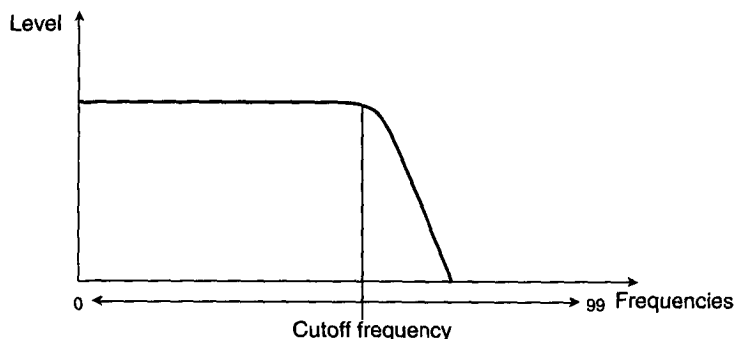

The VDF EG allows you to control brightness. The EGint (EG Intensity) parameter on the first page of 3A VDF allows you to determine how much the VDF EG will change brightness. The VDF EG does not affect the sound when the EGint parameter is set to 00. For Program A68: Soft Horns, you can check the effect of the VDF EG by changing the EGint value while the Fc parameter is set to 00. (If the Fc value is very high, you may not notice changes in tonal color produced by the VDF EG.)

Like the VDA EG, the VDF EG allows you to control how the tone of a Multisound changes over time after a note-on messages is received. You can increase or decrease the level based on the current Fc (cutoff frequency) setting of 00.

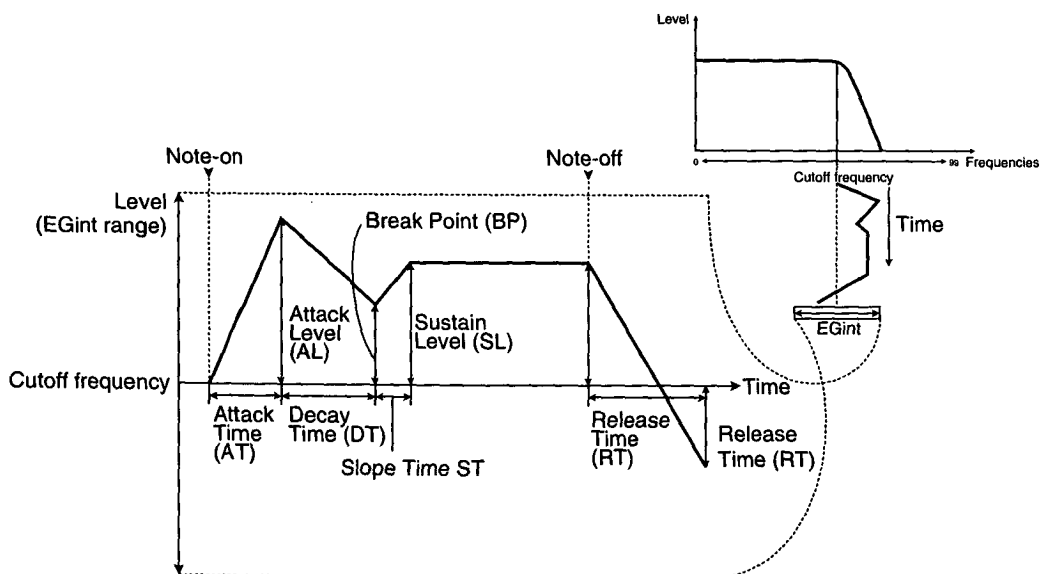

Set the Fc parameter to 00 and the EGint parameter to 99, and change the parameter values (3B – 3D VDF1 EG) to see how the tonal brightness changes over time.

Editing a Multisound (Basic Waveform)

Multisounds are the basic sound waveform (PCM waveform) used in Programs. The X5 contains 340 Multisounds, including instrumental sounds such as piano and guitar, rhythm sounds such as drums and percussion, and synth sounds. Changes in Multisounds are obvious in any Program. In this tutorial, we will use Program A01: Piano 16' for Multisound edit.

Select Program A01: Piano 16' in Program Play mode, and press the [EDIT] button to enter Program Edit mode. Press the [PAGE+] button once to display the 1A OSC1 SOUND screen.

This screen shows the number and name of the Multisound. Use the VALUE slider and the [▲/YES] and [▼/NO] buttons to change the Multisound. Then listen to the sound.

The other parameters (such as the VDF and VDA EG) are all set for the piano sound. Therefore, changing only the Multisound may produce an unnatural sound. (For example, the sound may still have a decay typical to the piano even if you select a brass instrument or organ sound for a Multisound.) However, editing these parameters according to the selected Multisound will create a completely new sound.

Adjusting Modulation

Vibrato (pitch modulation) and wah (VDF Cutoff modulation) are important effects that add expression to your performance. Let's change the depth, rate, and type of modulation.

Select Program A68: Soft Horns in Program Play mode, and press the [EDIT] button to enter Program Edit mode. Press the [PAGE+] button seven times to display the 7A PITCH 1 MG screen.

Playing this Program on the keyboard will not produce the vibrato effect. You need to operate the modulation wheel to produce the effect.

Raise the Int (Intensity) value of 7A PITCH 1 MG. As you raise the value from a default setting of 00, you will notice that the vibrato effect becomes obvious even you are just playing the keyboard. The depth of vibrato is set by this parameter. Raise the Int parameter value, then change the Freq (frequency) value. The Freq parameter is used to set the rate of vibrato. The higher frequency value will make the vibrato faster. Now, move the cursor to the field that shows "TRI" as a default value for the waveform, and change this option. This parameter controls the vibrato waveform (the manner in which the pitch changes).

The Wah effect (VDF Cutoff modulation) is set by 8A VDF MG (Set 8B Oscillator Select to any value other than OFF.). As with the 7A PITCH 1 MG, change the waveform, Freq, and Int to determine the resultant effects.

- You can also set the delay time (the time taken until the vibrato or wah effect starts) and the manner in which you control the modulation: via the keyboard, After Touch, or the modulation wheel. Refer to page 86 for details.

Adjusting Panpot

You can adjust the panpot setting (the position of the stereo image) when the stereo sound is output through the L/MONO and R connectors. Change the Pan (panpot) parameter on 1C OSC1 and check to see how the position of the stereo image has shifted (see page 72). Pan settings range between A and B, with CNT as the center. With the Pan parameter set to OFF, no sound will be output to A or B. (Select OFF when you are using only outputs C and D.)

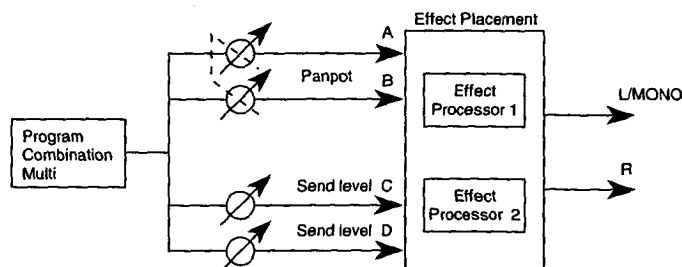

About Double Mode

Just as you can layer Programs in a Combination, you can layer Multisounds in a Program. In Program Edit mode, set the 0A OSC Mode parameter on the LCD screen to DOUBLE. Double mode allows you to combine different Multisounds in a Program (see page 70), or to produce a thick and rich sound. Most of the X5 Programs are in fact Double mode Programs.

It is a good idea to consider the type of Multisounds that comprise a Double mode Program when you are editing sounds in Program Edit mode.

- Remember that the X5 polyphony is reduced from 32 to 16 notes for Double mode Programs, since each Multisound uses one voice.

Double Mode and Combinations

There are two methods for layering multiple sounds: (1) using a Double mode Program; and (2) layering multiple Single mode Programs in Combination Edit mode. The resultant sounds are the same, but the method you choose should depend on how the sound will be used. For example, if you wish to layer completely different types of Programs—such as piano and strings—it is better to layer the Programs in Combinations. If the piano and strings sounds are different Programs, you can combine the piano and brass sounds, or the strings and brass sounds, allowing you to make the best use of the Programs. On the other hand, layering two Multisounds in Double mode is most suitable for combining two different sounds to build one Program. For example, if you wish to layer the attack and sustain parts of the strings sound, handling these two sounds in a Double mode Program is more convenient for sophisticated sound creation.

Some Hints for Editing Programs

There are many parameters in Program Edit mode, so you can create your original sound with ease. It may be difficult to understand all the parameters' functions, but editing various sounds repeatedly will help you learn the function and effect of each parameter.

You may often modify the preset Programs or existing Programs you have created before. In any case, the key approach for a creative sound making process is to be able to decide which parameters you need to edit to obtain a desired sound.

As explained in "Sound Structure" on page 35, the X5 Programs consist of three simple main elements. You should be able to obtain your desired sound easily based on the principle that OSC is for pitch, VDF is for tone, and VDA is for volume. You should also associate cyclical changes with MG, and changes over time with EG.

Depending on the value of one parameter, the other parameters may not be effective. For example, if you set the EGint (EG Intensity: VDF EG sensitivity adjustment) to 00, changing the parameters of the VDF EG will not modify the sound. You can save time and energy and perform an efficient edit by first understanding the structure of the Program.

Editing Effects

Now let's edit the effects, which are a prominent feature of the X5. An effects processor allows you to add various effects and acoustic ambience to a sound.

You can use the effects for Programs, Combinations, and Multi setup. This section explains the editing of effects in a Program. The effect parameters are common among all these modes, although they appear on different pages of the LCD screen.

① Select a Program in Program Play mode.

Program A01: Piano 16' is a suitable Program for assessing how effects modify the sound. Some Programs may not allow you to determine how effects modify a sound, depending on the placement of the effect. See page 115 for the effect placement.

② Press the [EDIT] button to enter Program Edit mode.

③ Press the [PAGE+] or [PAGE-] button to display 10A EFFECT 1.

④ Move the cursor to EFFECT 1=, and use the VALUE slider, [▲/YES] button, and [▼/NO] button to change the effect type.

- The effect placement of Program A01: Piano 16' is set to Serial. Let's check to hear how a different effect type for Effect 1 will alter the sound. If you have selected a Program for which the effect placement is set to any value other than Serial, change it to Serial (see page 115). Set Effect 2 on page 12A EFFECT2 to "00 No Effect".
- The DRY:EFF parameter allows you to adjust the effect degree of Effect 1 on 10B. (The page varies depending on the effect type selected on 10A EFFECT 1.) Increasing the EFF portion of the effect balance will make it easier to understand the impact of the effect.
- You can check the dynamic modulation effect by the modulation wheel when the 16C Src (Dynamic Modulation Control Source) parameter is set to JS(+Y) and the value of the I (Dynamic Modulation Intensity) parameter is raised. (see page 114.) Move the modulation wheel (Set 10A MG WHEEL in Global mode to JoyUp.) while playing the keyboard to listen to the effects.

Effect Types

The X5 features two built-in digital multi-effects processors. Selecting a different type of effect will create a different and versatile sound.

The effect types are divided into two main categories: the effects that create reverberation (acoustic ambience), and effects that will process sounds. Using the two built-in effect processors and the effect types that produce two effects simultaneously will allow you to both create acoustic ambience and process sounds.

This section explains the main effect types for the X5's 47 built-in effects. Other effect types are variations or combinations of these main effect types.

- Refer to page 118 for information about the parameter functions and how to control each type of effect.

1) Reverberation

Sounds exhibit a wide variety of reverberations, depending on the size of the surrounding acoustic environment and the materials used in nearby walls, ceilings, etc. Reverb is used to simulate these naturally-occurring reverberations for dry sounds (dry sound refers to the original sound without effects). The X5 features nine types of reverb effects - from 1:Hall through to 9:Spring.

Imagine listening to live music in a hall. After hearing the dry sound directly from the source, you will hear a number of sounds reflected from the walls, ceiling, floor, and any other objects with hard surfaces. These are called "early reflections". The mixture of the dry sound and reflecting sounds creates spatial effects. The time between the dry sound and these early reflections is called the pre-delay time, and it will vary depending on the size of the hall, the material used in the walls,

ceiling, and other objects in the room, and the decay time of the reflections. Utilizing the effect types 1:Hall through 9:Spring allows you to simulate a variety of acoustic ambiances, and you can edit these effects in detail using the parameters.

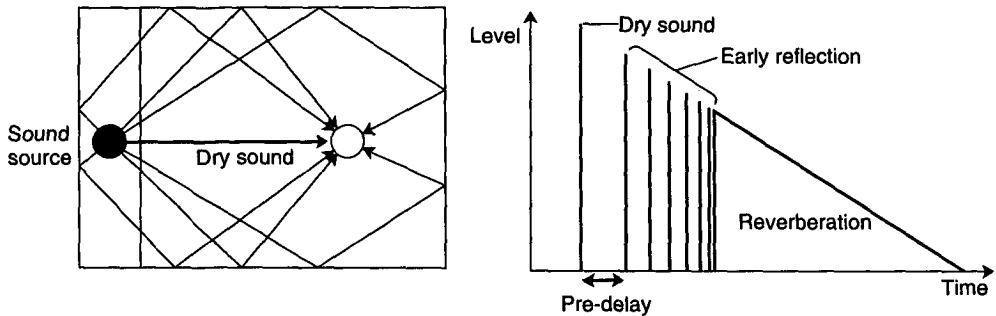

2) Early reflection

This effect produces only the early reflections of a reverb effect. Using just these early reflections, you can add weight or spatial effects to a sound, such as reverberation. Without the reverberation, you can achieve a clean effect sound.

3) Delay

Delay is like an echo in a canyon, consisting of a series of distinct repeats at regular intervals. Subsequent repeats can be added by feeding the signal back into the effect. The X5 contains six types of stereo delay, from 13:StereoDly – 18:M.TapDly. Short delay time settings will change the position of the stereo image (depth). Longer delay time settings are useful for soloing. It is also interesting to set a much longer delay time than that which would match the song's tempo.

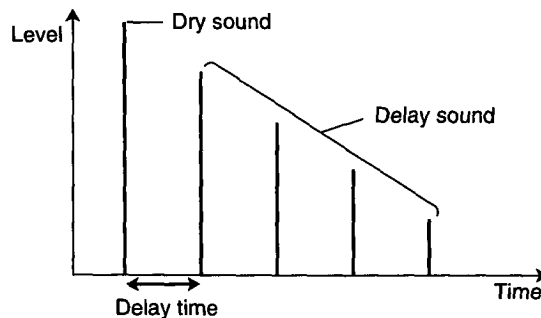

4) Chorus

Chorus effects are an effective way to add spaciousness and thickness to any type of sound. The X5 contains six chorus effects, from 19:Chorus1 to 24:Symp.Ens. These are ideally suited for use with electric pianos, strings, guitars, and so on. In an ensemble, pitch variations between instruments create a rich, slightly warbling sound. Essentially, this gives the impression that a number of musicians are playing together. The chorus effect simulates this. In stereo performance, the stereo image is widened, thus creating a magnificent spatial ambience.

5) Flanger

These effects add unique characteristics to a sound. The X5 contains three flanger effects, from 25:Flanger 1 through 25:XOvrFlng. Although similar to chorus, a flanger uses a shorter delay time and feeds some of the output signal back into the effect, creating a strong swell. Flangers work very well on sounds that contain a lot of harmonics, as well as on distorted guitar sounds.

6) *Exciter*

The exciter effect (28:Exciter) adds new harmonics to a sound, thus producing a subjective increase in clarity and definition, which helps to make a sound's individual character stand out.

7) *Enhancer*

The enhancer (29:Enhancer) makes the sound clearer and more defined, giving the sound more presence and bringing it up front in the mix.

8) *Distortion*

The X5 contains two kinds of distortion effects, 30:Dist and 31:over Drv. The distortion effect simulates the distortion produced when amplifier circuits are overdriven with excessive signal and gain levels. You can use these effects not only with guitar sounds but also with rock organ sounds.

9) *Phaser*

The phaser effect shifts a sound's phase. The X5 contains two phaser effects, 32:Phaser 1 and 33:Phaser 2. They are similar to the chorus and flanger effects in that both use modulation, but the manner in which the tonal quality changes is different. They are effective with electric piano, guitars, and synth sounds with a reasonable sustain.

10) *Rotary speaker*

This effect (34:Rot.SpK) simulates the rotating speaker effect used in organs. It is ideal for use with organ sounds, but it will also create a unique effect with other sounds.

11) *Tremolo*

The tremolo effect produces regular changes in volume level. The X5 contains two tremolo effects, 35:Auto Pan and 36:Tremolo. They create a stereo type tremolo effect on electric pianos and vibraphones.

12) *Parametric equalizer*

Effect 37:Para.EQ is a three-band parametric equalizer. You can set the cutoff frequency for the low and high band filters, and center frequency and bandwidth for the mid-band filter, which allows you to modify the tonal quality of a sound in detail. This effect can be used to simulate the frequency responses unique to an instrument (resonance of guitars and other string instruments), as well as to correct the tonal quality.

- Refer to page 118 for information about how the effect type parameter functions.

Effects and Sound Level

You can use the effects in Program Play mode, Combination Play mode, and Multi mode. However, the effects are set for each sound—that is, the effects are set for each Program. Combinations use the effects that are set for each Combination (and not the effects that are set for the Programs assigned to the Timbres). Multi mode uses the effects that are set for the entire Multi mode (and not the effects set for the Programs in the tracks). Remember this when you use the Programs that utilize their own effect settings in Combination Play mode and Multi mode.

- You can make a copy of the effect settings for Programs using the Copy Effect function. (see page 117.)

Editing Combinations

This section offers a tutorial on the Combination Edit function. In the example described below, we will not save the edit to memory. (If you wish to save an edited Combination, you must perform a Combination Write operation.)

- If you do not save the edited Combination, the existing Combination will not change. (Refer to page 104 for information on the Combination Write operation.)

Layering Multiple Programs

You can create a new sound by combining multiple Programs in a Combination. In the following example, we will edit Combination 01:LayerPiano.

- 1 Select Combination 01:LayerPiano in Combination Play mode.
- 2 Press the [EDIT] button to enter Combination Edit mode.
Before editing a Combination in Combination Edit mode, you must select a Combination in Combination Play mode.
- 3 Press the [PAGE+] or [PAGE-] button to display the appropriate page on the LCD screen.
 - You do not have to switch pages; you change Programs in 0A PROGRAM 1-4.
- 4 Press the [◀] and [▶] cursor buttons to select a Timbre.
- 5 Use the VALUE slider and the [▲/YES] and [▼/NO] buttons to select a Program.

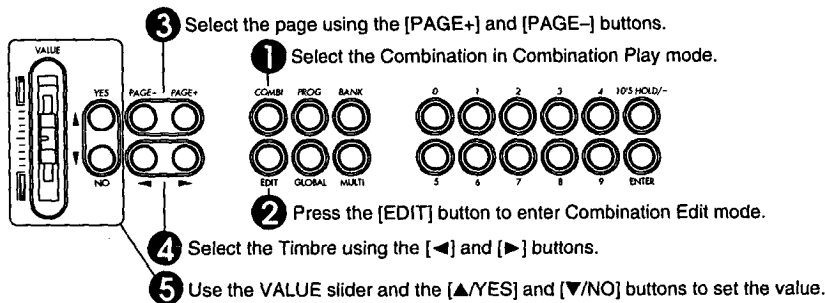

Change the Programs assigned to Timbres 1-3 and listen to how the sound changes. Combination 01:Layer Piano consists of different Programs assigned to three Timbres as illustrated below. (Timbres 4-8 are not used.)

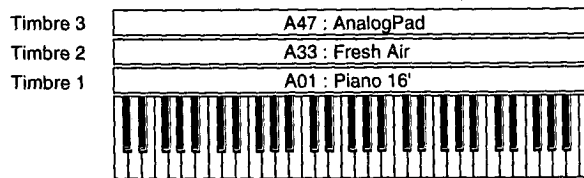

You can select Programs to assign to Timbres 1-8 in the 0A and 0B PROGRAM. If you select OFF, that Timbre will not be used.

Adjusting the Volume

You can adjust the volume level of each Timbre using the 1A and 1B LEVEL. The Volume balance among Timbres can affect the sound of the Combination.

These are the default settings for each Timbre's volume level for Combination 01:LayerPiano: 117 for A01:Piano 16'; 080 for A33:Fresh Air; and 060 for A47:AnalogPad. As you can tell from these settings, the main sound of this Combination is the piano. You could adjust these levels to make this Combination into a pad-type sound by emphasizing the sounds of A33:Fresh Air and A47:AnalogPad.

Adjusting the Key Window

You can set the note range for each Timbre in a Combination such that each Timbre will sound only within its specified range on the keyboard. This range is called the Key Window.

The Key Window is specified by the upper and lower limits of the note range: 3A and 3B KW TOP (Key Window Top) and 3C and 3D KW BTM (Key Window Bottom). The default setting is C-1–G9 (the entire keyboard range). However, you can specify a certain range or divide the keyboard range in two for each Timbre for use in Split mode.

For example, change the KW BTM of Timbre 1 to C4 and KW TOP of Timbre 3 to B3, and you can play pad-type Programs A33:Fresh Air and A47: Analog Pad in the low range, and piano Program A01:Piano 16' in the high range.

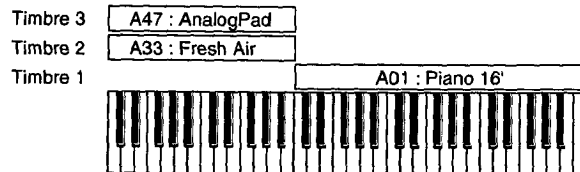

Adjusting the Velocity Window

You can also specify the note range within which a Timbre will respond based on the force with which you strike the keys (velocity range). This velocity range is called the Velocity Window.

The Velocity Window is specified by 4A, 4B VW TOP (Velocity Window Top) and 4C, 4D VW BTM (Velocity Window Bottom), which represent the upper and lower velocity limits. Velocity (how hard you strike the keys) is expressed by the numbers 001–127. The default velocity range is 001–127 (in which Timbres respond to any velocity). By changing these parameters, you can set the Timbres in such a way that different Timbres will respond to different key touches.

For example, first reset the Key Window parameters to the default setting. Then change Timbre 1 VW BTM to 64, and VW TOP of Timbres 2 and 3 also to 63. When you play the keyboard softly, only the pad-type Programs A33:Fresh Air and A47:AnalogPad will sound; when you play the keyboard hard, the piano Program A01:Piano 16' will sound.

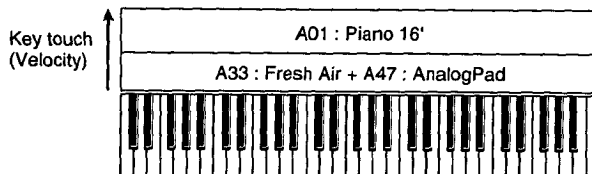

More About Combination Edit

So far we have learned how to switch Programs, adjust the volume, and set the Key Window and Velocity Window. These represent a basic use of the Combination edit functions.

You can edit Combinations further by doing such things as changing the pitch for each Timbre (transposition, detune - page 99), and adjusting the pan (see page 102) and effect send (see page 103) settings. You may also set a different MIDI channel for each Timbre to play via multiple MIDI Channels (see page 96).

Editing a Drum Kit

A Drum Kit is a set of drum sounds, each of which is assigned to a key on the keyboard. You can play a Drum Kit instead of Multisounds by selecting DRUMS for Programs. The Drum sounds on the X5 are arranged into 8 Drum kits in ROM and 2 Drum kits in RAM. You can edit RAM kits in Global mode. This section explains how to edit RAM kits.

Preparing to Play a Drum Kit

To play a Drum Kit, you need to select DRUMS for 0A OSC Mode in Program Edit mode. In this mode, you can select a Drum Kit instead of Multisounds for 1A OSC1 SOUND.

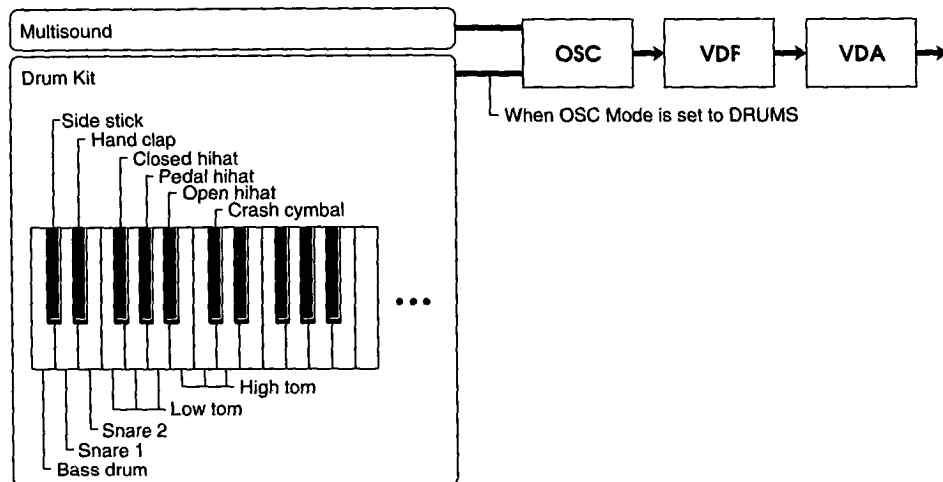

Editing a Drum Kit

Let's edit Drum Kit A09:Total Kit, which uses one of the RAM Drum Kits (000:Drum Kit 1). If you wish to edit a ROM Drum Kit, first copy the ROM Drum Kit to one of the RAM Drum Kits using 8A Copy Drum Kit in Global mode. (see page 160.)

- Editing this Drum Kit will change the arrangement and settings of the drum sounds. If you wish to restore the original setting, do so using 5A Preset Data Load in Global mode.

Tips on drum editing

Before starting to edit a Drum Kit, we recommend that in Program Play mode you select a Program for which Drum mode is already set. This is because the parameter settings of the Program selected in Program Play mode are used to produce sound, and depending on the VDF, VDA, or EG settings of typical Program sounds—such as piano or strings—the drum sounds may change. For example, if a Program uses a long attack time for the VDA EG, you cannot recognize the sharp attack typical of a drum sound. If you wish to reproduce the edited Drum kit sound without any changes, use the Drum kit in a Program that has been selected in Program Play mode. Also, it should be noted that editing a Drum Kit will change other Program sounds that use the same Drum Kit. For example, editing Drum Kit 1 will change all Program sounds that use Drum Kit 1 (the Programs for which 000:Drum Kit 1 is selected for OSC1 SOUND).

- ❶ Select A09:Total Kit in Program Play mode.
 - When you edit a Drum Kit in Global mode, the currently-selected Program settings (DRUMS for OSC Mode) are used to produce the sound. Make sure you select a Program that contains a Drum Kit you wish to edit, or select a Program from G129–136.
- ❷ Press the [GLOBAL] button to enter Global mode.
- ❸ Press the [PAGE+] or [PAGE-] button to display 6A Drum Kit 1. (This is the edit page of Drum kit 1.)
- ❹ Use the [◀] and [▶] cursor buttons to select a parameter.
- ❺ Use the VALUE slider, and the [▲/YES] and [▼/NO] buttons to set the value.

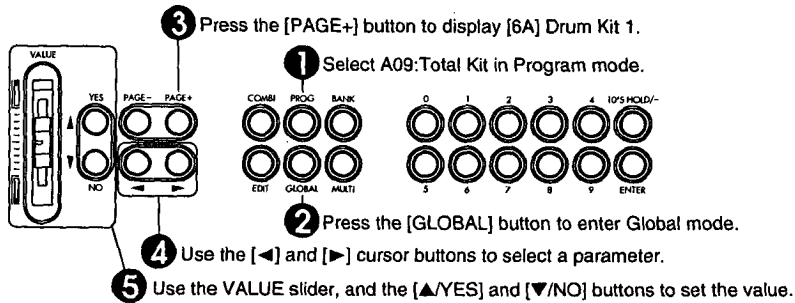

Each Drum Kit contains 60 indexes (#00–#59), with one drum sound assigned to each index. Level, tuning, and decay parameters can be set individually for each index in a kit. Each index is similar to a container that accommodates a drum sound; it appears on the LCD screen as follows:

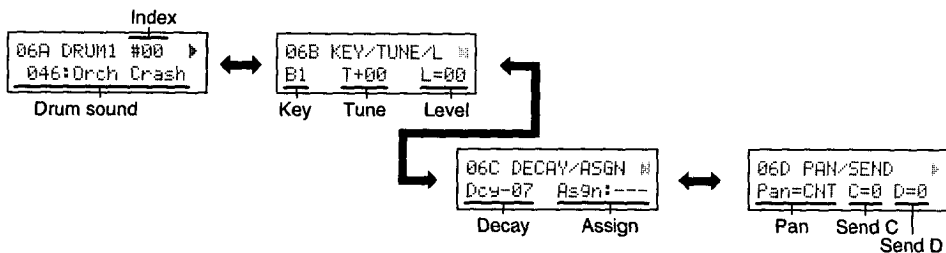

Now, we start editing Drum Kit 1, which is used in A09:Total Kit.

First, to select an index to edit, move the cursor to Index on page 6A DRUM 1, and select #06, which is an index for the snare assigned to the F2 key (the lowest F on the keyboard). Pressing the F2 key while pressing and holding down the [ENTER] button will automatically select the index (#6) assigned to this key. This procedure is useful when you want to edit the index after playing the corresponding key to check the sound. When the cursor is located on the key parameter, you can enter a key name directly by playing the corresponding key on the keyboard while holding down the [ENTER] button.

Changing Drum Sounds

As a default setting, drum sound 018:PicloSnare (the high-pitched sound of a thin-body snare) is selected. Try to select various drum sounds and listen to them. Selecting —:No Assign allows you to set an index that does not produce sound. In this case, select a powerful snare sound 022:Ambi.Snare.

Changing the Assigned Key

Page 6B KEY/TUNE/L allows you to change the key assignment. Changing the default setting F2 allows you to change the key to which an index is assigned. You can select only the keys from A#1 and lower or G#6 and higher. This is because you cannot assign multiple indexes to one key.

(The keys not shown on the screen are already assigned indexes.) If you wish to assign an index to a particular key, edit the index of that key or change the key of the index. Avoid assigning indexes to the same key.

Altering the Tuning

You can change the pitch of drum sounds. The default value is +006, and the value can range from -120 to +120 (1 = 10 cents). Altering the tuning will significantly change the nuances of a drum sound. Raising or lowering the pitch radically can create special effects. Set this to about +30 to obtain a clear sound, and to about -10 to obtain a powerful sound.

Changing the Level

Now, go to 6C DECAY/ASGN. The Level is adjusted for each index. You can adjust the entire volume level using the OSC Level parameter in Program Edit mode or the MASTER VOLUME slider, but the volume level balance of index's drum sound in a Drum Kit is adjusted by this parameter. The default value +60 may produce a rather loud sound for the index we are now editing. Set the parameter to about +10.

Changing the Decay

Now, go to 6C DECAY/ASGN. You can adjust the decay time (how long a sound sustains) using the decay parameter. The higher value will produce a longer sustain, based on a value of 0. Specifying a negative value will make the sound shorter. For example, adjusting the decay time is very useful for a cymbal sound. Try a value of -25 to create a tight sound.

About the other parameters

The ASGN (Exclusive Assign) allows you to set an assigned group of indexes such that they will not produce the sound of (alternate assign). For example, the open hihat sound and the closed hihat sound should not be triggered simultaneously. This parameter can be used for a whistle, giro, quaker, or triangle.

Page 6D PAN/SEND allows you to control how the sound is output for each index. The Pan parameter determines the output balance between Output A and B, and the C and D parameters determine the output level to C and D. The panpot setting specified in Global mode is effective in Program Play mode, and each index uses its own panpot setting. If you set the panpot parameter to PRG in Combination Play mode or Multi mode, each index uses its own panpot setting.

Playing a Chromatic Scale Using a Single Drum Sound

As described earlier, you can assign the drum sounds in a Drum Kit to different keys. In a similar way, you can also play a chromatic scale using a single drum sound. The example described below is a bell sound.

Since the indexes of Drum Kit 1 are already assigned to the entire keyboard as a default setting, first you need to set drum sounds of indexes #50-#59 to —:No Assign, and set the key of index #59 to any key other than C7. At this point, no index should be assigned to the highest octave keys on the keyboard (no sound will be produced within this range). Set Index #40 to 137:TubulBell2,

and set the key to C7. Now you should be able to play the bell sound in a chromatic scale within the highest octave. The sound may become more interesting if you tune it a little lower and set the decay to -15.

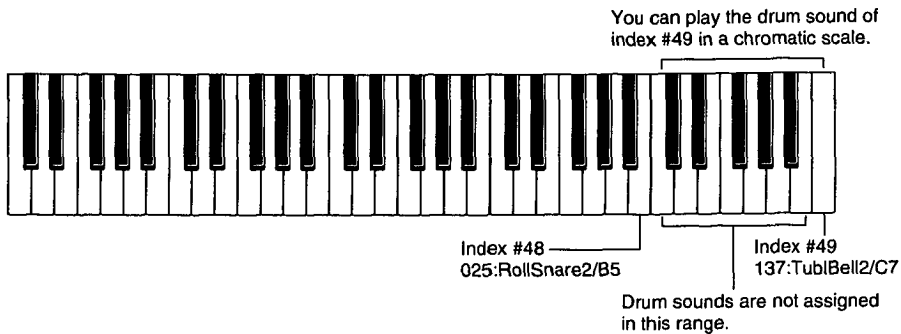

Creating a Drum Program Using a ROM Drum Kit

Follow the procedure below to copy a Program and Drum Kit when you edit the ROM Drum Kits used in Programs G129-136.

- 1 Copy a Program to Bank A.**

You cannot write a Program in Bank G. Select a Program in Program Play mode, and write the Program using the 16A page in Program Edit mode.
- 2 Check and confirm the ROM Drum Kit being used.**

Check the number of the ROM Drum Kit being used in the copied Program using the 1A page in Program Edit mode.
- 3 Copy the ROM Drum Kit to a RAM Drum Kit.**

Use the 8A page in Global mode to copy the ROM Drum Kit that you have just checked in Step 2 onto RAM Drum Kit 1 or 2. When the copy function is carried out, the sound of the Program that previously used the RAM Drum Kit will change.
- 4 Edit the RAM Drum Kit.**

Edit the RAM Drum Kit in Global mode. Refer to "Editing a Drum Kit" on page 48 for editing procedures.
- 5 Change the Multisound of the copied Program to the copied RAM Drum Kit.**

Go back to Program Edit mode, and change the Drum Kit selection on page 1A. Select the destination RAM Drum Kit 1 or 2 in Step 3, and perform 16A write function.

Making Drum Sounds

The X5 handles two RAM Drum kits and eight ROM Drum kits edited in Global mode as a sound source like a Multisound, which allows you to fine-tune the sound using the parameters available in Program Edit mode. For example, it is possible to adjust tonal brightness using the VDF, or to adjust changes in tonal color and level using the VDF EG and VDA EG respectively, to obtain special effect sounds. You can utilize effects advantageously by setting the panpot for each index, or adjusting the send C/D levels. For example, you may apply reverberation to only the snare sound, or apply the flanger effect to only the hihat sound.

Program Sound Making: Practice

In this section, we are going to create a new sound (Program) on the X5. Although this section explains a sequential procedure for creating sound and setting important parameters, the functions of each parameter are not covered in detail. If necessary, please refer to “Parameter Guide” section, which starts on page 68, for details.

Protecting the Memory

Programs created in Program Edit mode will be lost if you do not write (save to memory) the parameter values you edited. You can write your own Programs on Programs 00–99 in Bank A. However, these Programs are memory-protected in Global mode so that you will not accidentally overwrite an existing Program. If you plan to write a new Program in one of the Programs in Bank A, first set the Memory Protect parameter in Global mode to OFF.

- ❶ Press the [Global] button to enter Global mode.
- ❷ Press the [PAGE+] or [PAGE-] button to display 3A PROTECT on the screen.
- ❸ Use the VALUE slider or [▼/NO] button to set the PROGRAM to OFF.

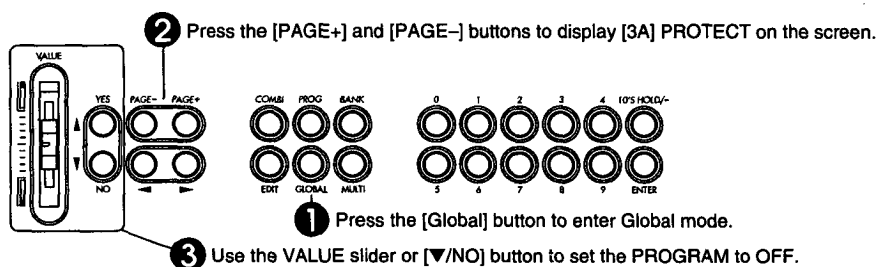

- In this practice example, we use Program A00 Sunrise as a destination. Writing a new Program in A00 will destroy the Program data previously stored in A00. You can restore these factory default settings using 5A PRESET DATA in Global mode (see page 156).

Setting the Parameters

The table below is an example of the contents of a parameter.

LCD	Parameter	Range		Description	P	
4A/6A	VDF Cutoff (Fc)	12	33	Adjusts tonal brightness.	76	81

LCD

This shows the number of the page displayed on the LCD screen. Use the [PAGE+] and [PAGE-] buttons to change pages. If a page has multiple screens, use the [◀] and [▶] cursor buttons to switch screens. If this column shows two page numbers, such as 4A/6A, they specify the pages for Oscillators 1 and 2, respectively. For example, 4A/6A corresponds to VDF1 and VDF2, respectively.

Parameter

This indicates the name of the parameter. Words inside the parentheses are abbreviations of the parameter titles shown on the LCD screen.

Range

Set a parameter to this value. If two values are shown, they correspond to the value of Oscillators 1 and 2. In the example table, Fc (VDF Cutoff) of VDF1 is set to 12, and Fc of VDF2 is set to 33.

Description

This column explains the parameter function and some key points of the parameter setting.

P

This shows the reference page “Parameter Guide”. Refer to this page for detailed parameter functions and an explanation of the values.

Let’s start creating a sound using the procedure below.

- ❶ Select Program A00 Sunrise in Program Play mode.
- ❷ Press the [EDIT] button to enter Program Edit mode.
- ❸ Use the [PAGE+] and [PAGE-] buttons and select a parameter using the [◀] and [▶] buttons.
- ❹ Use the VALUE slider, and the [▲/YES] and [▼/NO] buttons to set the parameter value.

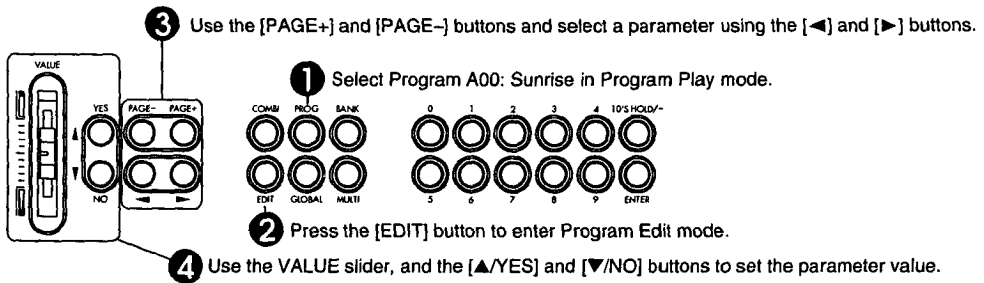

Notes on Sound Making

If you turn off the power to the X5, or select a different Program in Program Play mode while or after editing a Program, all of your edited data will be lost—unless you save the data using the Write function! If you want to stop editing and do something else on the X5, be sure to carry out the Program Write function. See page 61 for a detailed procedure for the Program Write function.

Sound Making

The following pages explain parameter functions and offer hints on settings. Depending on the settings of other parameters, you may not be able to confirm how changes in the parameter value affect the sound. In other cases, the sound may be produced incorrectly. Therefore, set all the parameters to the values shown on the next page; then read the explanation of the parameter functions and hints.

OSC

LCD	Parameter	Range	Description	P
0A	OSC Mode	DOUBLE	DOUBLE: layers sounds using double oscillators.	70
0B	Assign (ASN)	POLY		70
	Hold (HLD)	OFF		70
1A	OSC1 Multisound	320	The name of Multisound #320 is "VS 52."	71
1B	OSC1 OSC Level (Level)	54	Determines the volume level.	71
	OSC1 Octave (OCT)	16'		71
1C	OSC1 Pitch EG Intensity (EGint)	+00		72
	OSC1 Pan	CNT		72
1D	OSC1 Send C (C/D SEND)	0		72
	OSC1 Send D	0		72
2A	OSC2 Multisound	166	The name of Multisound #166 is "AnaStrings."	73
2B	OSC2 OSC Level (Level)	27	Determines the volume level. (To adjust the balance with OSC1)	73
	OSC2 Octave (OCT)	4'		73
2C	OSC2 Pitch EG Intensity (EGint)	+00		73
	OSC2 Pan	OFF	With the OFF setting, no signal will be output from A/B.	73
2D	OSC2 Send C (C/D SEND)	9	Applies only reverberation.	73
	OSC2 Send D	9	Applies only reverberation.	73
2E	OSC2 Interval (Intvl)	+00		73
	OSC2 Detune (Detn)	-05	Thickens the sound by shifting a pitch very slightly.	73
2F	OSC2 Delay Start (Delay)	17	Produces the sound with a delay.	73
3A	Pitch EG Start Level (SL)	+00	Pitch EG is not effective, since the Gint parameter of the OSC1/2 is set to +00.	74
	Pitch EG Attack Time (AT)	00	Pitch EG is not effective, since the Gint parameter of the OSC1/2 is set to +00.	74
	Pitch EG Attack Level (AL)	+00	Pitch EG is not effective, since the Gint parameter of the OSC1/2 is set to +00.	74
3B	Pitch EG Decay Time (DT)	00	Pitch EG is not effective, since the Gint parameter of the OSC1/2 is set to +00.	74
	Pitch EG Release Time (RT)	00	Pitch EG is not effective, since the Gint parameter of the OSC1/2 is set to +00.	74
	Pitch EG Release Level (RL)	+00	Pitch EG is not effective, since the Gint parameter of the OSC1/2 is set to +00.	74
3C	Pitch EG Level Vel. Sens. (Levl)	+00	Pitch EG is not effective, since the Gint parameter of the OSC1/2 is set to +00.	74
	Pitch EG Time Vel. Sens. (Tim)	+00	Pitch EG is not effective, since the Gint parameter of the OSC1/2 is set to +00.	74

The OSC Mode parameter of this Program is set to DOUBLE to layer two sounds in Double Oscillator mode. The OSC1 uses the electric piano sound, and the OSC2 uses the strings sound. The sparkling electric piano sound is followed by a delayed soft strings sound. The Pan setting of the OSC2 is OFF to output the signal to only C and D in order to use two effects advantageously.

Although this Program does not use Pitch EG, you can use Pitch EG to change pitch. To do so, set the pitch envelope in pages 3A–3C, and raise the Pitch EG Intensity of OSC1 and 2 (1C and 2C) to an adequate level.

• **Hint 1 for sound making: Multisound**

The X5 has various built-in Multisounds with names. However, try to use them freely, without being restricted by the names. The X5 offers very interesting synth sound waveforms in the latter half of the 340 Multisounds, such as Multisound 320:VS 52. You can also play drum or percussion Multisounds in a chromatic scale. Select a desirable Multisound while listening to it. Usually, a Multisound is selected first, then other parameters are adjusted according to the selected Multisound.

Hint 2 for sound making: Detune

The Detune parameter on 2E OSC2 is used to slightly shift the pitch of OSC2 against OSC1. Shifting the pitch between double oscillators thickens the sound, and is frequently used in sound making in Double Oscillator mode. The detune is more effective when it is used for Programs that use the same type of Multisounds for OSC1 and OSC2.

VDF

LCD	Parameter	Range		Description	P	
4A/6A	VDF Cutoff (Fc)	12	33	Adjusts tonal brightness.	76	81
	VDF EG Intensity (EGint)	80	22		76	81
4B/6B	VDF EG Attack Time (AT)	00	50	VDF2 adjusts the tonal color so that tonal color becomes brighter gradually.	77	81
	VDF EG Attack Level (AL)	+99	+99		77	81
	VDF EG Decay Time (DT)	35	61		77	81
4C/6C	VDF EG Break Point (BP)	+70	+99	VDF1 adjusts the tonal color so that tonal color becomes darker gradually.	77	81
	VDF EG Slope Time (ST)	93	75		77	81
	VDF EG Sustain Level (SL)	+48	+99		77	81
4D/6D	VDF EG Release Time (RT)	99	99		77	81
	VDF EG Release Level (RL)	+50	-22		77	81
4E/6E	Color Intensity (Int)	00	24	VDF2 adds a slight character to the sound.	77	81
	Color by Velocity Sens (Vel)	+00	+00		77	81
5A/7A	VDF EG Intensity by Vel Sens (EGint)	+60	+60		78	81
	VDF EG Time by Vel Sens (EGtm)	00	00		78	81
5B/7B	VDF EG Attack Time Vel. Sens (AT)	0	0		79	81
	VDF EG Decay Time Vel. Sens (DT)	0	0		79	81
	VDF EG Slope Time Vel. Sens (ST)	0	0		79	81
	VDF EG Release Time Vel. Sens (RT)	0	0		79	81
5C/7C	KBD Tracking Key	C4	C4		79	81
	KBD Tracking Mode (Mode)	ALL	ALL		79	81
5D/7D	KBD Tracking Intensity (Int)	+50	+50		80	81
	VDF EG Time by KBD Track (EGtm)	00	00		80	81
5E/7E	VDF EG Attack Time KBD Track (AT)	0	0		80	81
	VDF EG Decay Time KBD Track (DT)	0	0		80	81
	VDF EG Slope Time KBD Track (ST)	0	0		80	81
	VDF EG Release Time KBD Track (RT)	0	0		80	81

Set the VDF parameters for both VDF1 and VDF2. This Program uses two Multisounds that have a long sustain (the sound continues until you release the key), and the VDF EG and VDA EG adjust changes in tonal color and volume level over time. The following diagrams show how the VDF1 EG and VDF2 EG are set.

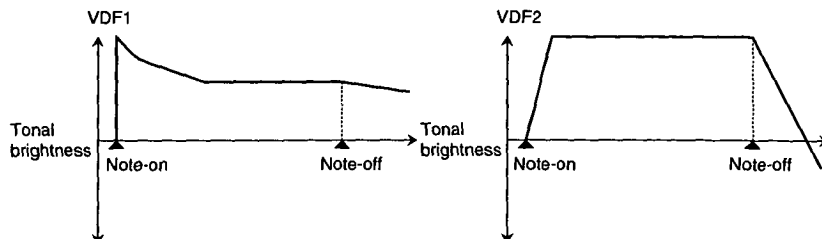

The electric piano sound for the OSC1 starts with a sparkling attack sound, and becomes darker gradually. The strings sound for the OSC2 becomes brighter gradually, then becomes darker after the Note-off message.

☛ **Hint 3 for sound making: Cutoff and EG intensity**

Tonal brightness is changed by the VDF EG and EG Intensity settings, as well as the VDF Cutoff parameter. For example, the VDF EG setting affects changes in tonal color because of a high value of the EG Intensity parameter, although the VDF Cutoff parameter of the OSC1 is rather low. On the other hand, the VDF Cutoff value is higher relative to the OSC1, although a low value of EG Intensity for the OSC2 makes tonal color darker. In this way, the VDF Cutoff, EG Intensity, and VDF EG parameters are closely related to each other in terms of tonal color. As a general approach, try setting the VDF EG value to determine how tonal color changes overall, then set the EG Intensity value to adjust the degree of change, and set the VDF Cutoff value to adjust the overall tonal brightness. In this way, you can hear the extent to which tonal color changes, and then fine-tune the parameter values.

☛ **Hint 4 for sound making: VDF EG and VDA EG**

Tonal color is also affected by the VDA EG setting (changes in volume level). For example, any value set for the VDF EG Release Time parameter does not affect the sound at all if the VDA EG Release Time is set to 00 (the sound will stop immediately after the Note-off message is received). A sound with a slow attack varies slightly depending on whether VDA or VDF has a faster attack. If the VDF EG has a faster attack, the sound becomes relatively quiet (like strings). If the VDA EG has a faster attack, the attack part sounds rather unique (a little like a brass sound). You should take into consideration how the VDF EG and VDA EG change over time.

VDA

LCD	Parameter	Range		Description	P	
8A/10A	VDA EG Attack Time (AT)	0	70	VDA2 sets a slow attack.	82	86
	VDA EG Attack Level (AL)	99	99		82	86
	VDA EG Decay Time (DT)	79	53	VDA1 sets a decay sound (the volume level decays gradually).	82	86
8B/10B	VDA EG Break Point (BP)	00	80		82	86
	VDA EG Slope Time (ST)	00	32		82	86
	VDA EG Sustain Level (SL)	00	78		82	86
8C/10C	VDA EG Release Time (RT)	00	56	VDA2 adds a release sound.	82	86
9A/11A	VDA amp by Velocity Sense (Amp)	+67	+31		83	86
	VDA EG Time by Vel Sense (EGtm)	00	15		83	86
9B/11B	VDA EG Attack Time Vel Sense (AT)	0	+	VDA2 sets the attack time that is controlled by key velocity.	84	86
	VDA EG Decay Time Vel Sense (DT)	0	0		84	86
	VDA EG Slope Time Vel Sense (ST)	0	0		84	86
	VDA EG Release Time Vel Sense (RT)	0	0		84	86
9C/11C	KBD Tracking Key	C3	C3		84	86
	KBD Tracking Mode (Mode)	LOW	LOW		84	86
9D/11D	VDA amp by KBD Tracking (Amp)	+13	-13		85	86
	VDA EG Time by KBD Track (EGtm)	00	00		85	86
9E/11E	VDA EG Attack Time KBD Track (AT)	0	0		85	86
	VDA EG Decay Time KBD Track (DT)	0	0		85	86
	VDA EG Slope Time KBD Track (ST)	0	0		85	86
	VDA EG Release Time KBD Track (RT)	0	0		85	86

The VDA allows you to control how the volume level specified by the VDA EG changes over time. The VDA1 for the OSC1 makes an electric piano sound with a rapid decay, and the VDA2 for the OSC2 makes a sustained strings sound, followed by a release. You can sustain the electric

piano sound (OSC1) using a damper pedal. If you are not using a pedal or if the pedal is assigned to another function, you may want to raise the Release Time value of the VDA1 EG. The following diagrams illustrate how the VDA EG for each oscillator has been set.

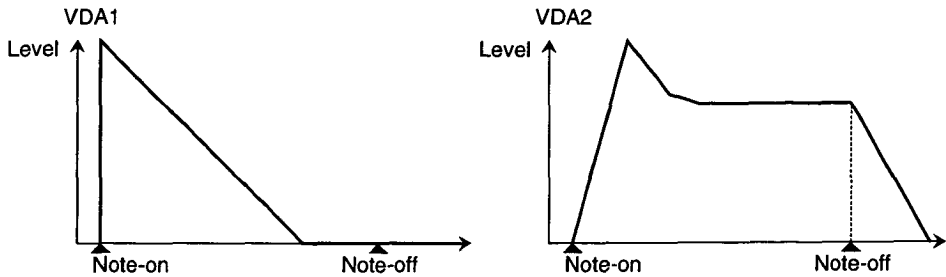

The VDA Velocity Sense parameter has a rather high value in order to add dynamic control via key velocity. The attack time of the OSC2 strings sound changes according to key velocity (EG Time Vel.Sens, Attack Time). With a soft key stroke, the attack becomes very slow. With a strong key stroke, the attack is quite fast.

☛ **Hint 5 for sound making: Key velocity and expression**

In order to add expression to your performance, you may set the parameters such that tonal color and volume level will change according to how hard you strike the keyboard (key touch or key velocity). Use the VDA Velocity Sense parameter for dynamic control of the volume level. Use the Velocity Curve parameter in Global mode to set the key velocity sensitivity. Use one sound as a standard to set the Velocity Curve parameter for the other sound so that sensitivity is balanced between the sounds. Then, use the VDA Velocity Sense parameter for each Program to set sensitivity. With a negative value for the VDA Velocity Sense parameter, a faster key velocity will produce a lower volume level. This setting is rare in Single oscillator mode. However, when you are using a Double oscillator Program, setting the VDA Velocity Sense for either Program to a negative value will produce a velocity crossfade effect, allowing you to control the level balance between two sounds using key velocity.

☛ **Hint 6 for sound making: Keyboard tracking**

Keyboard Tracking is the function that determines how different areas of the keyboard affect tonal color and volume level. For a sound that is more striking in the lower range, you may want to set the Keyboard Tracking so that the lower range of the keyboard you play (the lower the pitch becomes), the softer (lower in volume level) the sound. In this Program, the strings sound in the lower range is relatively loud. If you set the Key parameter of the OSC 1 and 2 in Double Oscillator mode, and reverse the positive and negative value for the KBD Track Intensity, you will obtain a positional crossfade effect that will change the volume balance between OSC 1 and 2 depending on the position of the key you play.

Pitch Modulation/VDF Modulation/After Touch, Joy Stick Control

LCD	Parameter	Range		Description	P	
12A/13A	Pitch MG 1/2 Waveform	TRI	TRI	Select TRI (triangle waveform) for a standard vibrato.	87	88
	Pitch MG 1/2 Frequency (Frq)	53	53		87	88
	Pitch MG 1/2 Intensity (Int)	00	00	00: Using only the keyboard for performance will create no vibrato.	87	88
12B/13B	Pitch MG 1/2 Delay	00	00		87	88
	Pitch MG 1/2 Fade In (Fade In)	00	00		87	88
12C/13C	Pitch MG 1/2 Key Sync (K Sync)	OFF	OFF		87	88
12D/13D	Pitch MG 1/2 Frequency Mod by KBD Track (K.TRK)	+52	+52		87	88
	Pitch MG 1/2 Frequency Mod by After Touch+Joy Stick (A+J)	0	1		87	88
12E/13E	Pitch MG 1/2 Intensity Mod by After Touch (Aft)	00	00			88
	Pitch MG 1/2 Intensity Mod by Joy Stick (JoyUp)	00	04	Vibrato is added only to strings sound.		88
14A	VDF MG Waveform		TRI			89
	VDF MG Frequency (Frq)		50			89
	VDF MG Intensity (Int)		00			89
14B	VDF MG Delay		00			89
	VDF MG OSC Select (OSC)		BOTH			89
14C	VDF MG Key Sync (K.Sync)		ON			89
15A	After Touch Pitch Bend (P.Bend)		+00			90
	After Touch VDF Cutoff Frequency (FC)		+00			90
15B	After Touch VDF MG Intensity (VDF.MG)		00			90
	After Touch VDA Amplitude (Amp)		+00			90
15C	Joystick VDF MG Intensity (VDF.MG)		00			90
15D	Joystick Pitch Bend Range (P.Bend)		+02			91
	Joystick VDF Sweep Intensity (VDF)		+00			91

Pages Pitch Modulation, VDF Modulation, After Touch, and Joy Stick Control are used to specify how the vibrato or wah effect is created and how After Touch or the modulation wheel affects the sound. In this Program, using only the keyboard will create no vibrato or wah effect. Moving the modulation wheel (set to JoyUp in 10A Global mode) forward will add a vibrato effect to the OSC2 strings sound. (The modulation wheel is also used to adjust the balance between reverberation and dry sound. See page 114.) You can also control pitch, brightness, and volume level by setting the After Touch parameters.

➤ **Hint 7 for sound making: Vibrato and wah**

Vibrato and wah add expression to the sound. The X5 can control the vibrato and wah in several ways. No vibrato or wah is set for this Program, to facilitate playing chords. For a Single oscillator Program, it may be a good idea to apply vibrato by raising a value of the Intensity parameter of 12A/13A PITCH 1 MG. It is very effective to raise the value of the Delay and Fade In parameters so that the vibrato effect starts gradually after the Note-on messages. You can also control vibrato and wah via After Touch or the modulation wheel. The X5 does not have an After Touch switch on the keyboard, although the modulation wheel allows you to control After Touch (see page 27, 161). You can also control it from an external MIDI device. Whenever you fine-tune the parameters related to vibrato or wah, be sure to play the keyboard to confirm the effect.

Effect

LCD	Parameter	Range	Description	P
16A	Effect1 Effect Type	22	Selects 22:XOverCho.	114
	Effect1 Switch	ON		114
16B	Effect1 Dry:Effect Balance (Dry:EFF)	FX	Sets only to the effect sound.	114
16C	Effect1 Dynamic Modulation Control Source (Src)	NONE		114
	Effect1 Dynamic Modulation Intensity (I)	+00		114
17A	Effect1 Delay Time L (D. Time L)	011		125
	Effect1 Delay Time R (R)	013		125
17B	Effect1 Mod Depth (Mod)	37		125
	Effect1 Mod Speed (Mod SP)	27		125
17C	Effect1 Mod Shape	T+01		125
17D	Effect1 EQ Low (EQ.L)	+05		125
	Effect1 EQ High (H)	+06		125
18A	Effect2 Effect Type	01	Selects 01:Hall.	115
	Effect2 Switch	ON		115
18B	Effect2 Dry:Effect Balance (DRY:EFF)	70:30	Adjust the reverb balance.	115
18C	Effect2 Dynamic Modulation Control Source (Src)	JS (+Y)	Adjusts the balance between reverberation and dry sound.	115
	Effect2 Dynamic Modulation Intensity (I)	+08		115
19A	Effect2 Reverb Time (Time)	3.4	Sets reverberation longer.	119
	Effect2 High Damp (H.Dmp)	30		119
19B	Effect2 Pre Delay (P.Dly)	060		119
	Effect2 E.R Level (E.R)	62		119
19C	Effect2 EQ Low (EQ.L)	-04		119
	Effect2 EQ High (H)	+00		119
20A	Effect Placement	Serial		115
20B	Out3 Panpot (3=)	L	Distributes the signal input at Send C into stereo (L).	115
	Out4 Panpot (4=)	R	Distributes the signal input at Send D into stereo (R).	115

Effects play an important role in sound making. In this Program, the effect placement is Serial; Effect 1 uses Crossover chorus; and Effect 2 uses Hall. The effect parameters vary depending on the effect type you select. First set the Effect Type parameter on page 16A/18A EFFECT1/2; then set the effect parameters.

Crossover chorus is used to add spaciousness to the sound in this Program. Since the Pan parameter for OSC2 is OFF, this effect does not affect the OSC2. The OSC2 strings sound is output from C and D, and affected by only the Hall effect of Effect2. The following flow chart illustrates how the signal is routed from OSC1/2 through Effect 1/2.

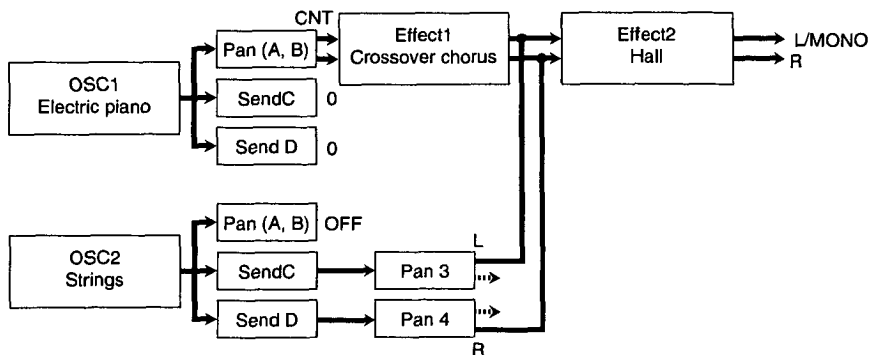

Setting the Dynamic Modulation Source to JS (+Y) for the Effect2:Hall allows you to control the dry:effect balance via the modulation wheel (set to JoyUp on Wheel function). Moving the modulation wheel forward (Control Change) will increase the reverberation applied to the hall effect.

☛ **Hint 8 for sound making: Effect placement**

The effect placement determines how the signal is routed from the OSC1/2 to the output through the Effect 1/2. This Program uses chorus and reverb. Selecting any other effect type will affect the sound. Routing the Pan A, B and Send C, D in various ways will allow you to build a complicated effect structure. Utilize the effect placement diagram for the effect settings.

☛ **Hint 9 for sound making: Dynamic modulation**

Dynamic modulation is a powerful function that allows you to control the effect balance and parameters while you are playing the keyboard. You can adjust the effects or obtain effects that could not be achieved through the usual external effect units, using the modulation wheel, assignable pedal, or VDA EG. The type of parameter you can control via dynamic modulation varies depending on the effect type. Refer to page 145 for detail.

Writing Programs

The Program Write function is used to store the Program edited in Program Edit mode. Follow the procedure below to write your Program into Bank A.

- ① Press the [PAGE+] button in Program Edit mode to display 22A PROG WRITE.
 - In this practice example, we will name the edited Program. You can also store the Program without changing the name.
- ② Press the [▶] button to display 22B RENAME.
- ③ Move the flashing cursor using the [◀] and [▶] buttons, and use the VALUE slider, and the [▲/YES] and [▼/NO] buttons to name the Program.
 - You can use up to 10 characters for the name. Enter the name "Epf+REVstr."
- ④ Press the [◀] button to go back to page 22A PROG WRITE.

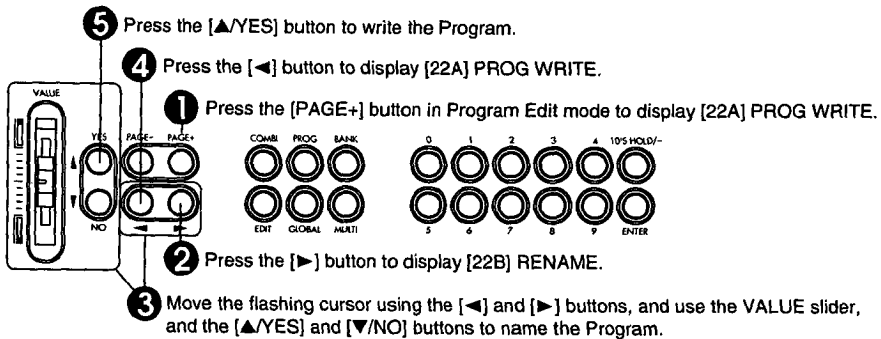

- ⑤ Move the cursor to "OK?" and press the [▲/YES] button. The screen will ask you "Are You Sure OK?". Press the [▼/YES] button to write the Program.
 - The Program will be written into Program A00. You can also specify the Program number using the Write parameter.

Now the Program "Epf+REVstr" has been stored in Program A00.

You can also explore parameter editing while checking the sound with your own ears to confirm how different parameters can affect the sound. Checking the parameter settings in Programs in Bank A or G can help you understand various key points of the sound making process. Experiment by editing various Programs.

Chapter 5: Application Guide

This chapter explains several applications and offers helpful tips on performance and editing on the X5. See the reference pages for detailed explanations of functions and parameters.

Performance Applications

Tuning the X5 to Other Musical Instruments

You should first tune the X5 if you plan to jam with other musical instruments or play along with music from CDs or tapes.

Use page 0A MASTER TUNE in Global mode to tune up. The range of the parameter is -50(427.47Hz) to +50 (452.89Hz). (see page 147.)

Changing the Key Velocity Sensitivity

Key touch—in other words, how hard you play the keyboard—varies with each player. You can set the key velocity sensitivity according to your own key touch. A velocity curve determines the relationship between key touch and changes in volume or tonal color.

Use the Vel parameter on page 0D CURVE in Global mode to select a velocity curve. The X5 has 8 velocity curves.

When you send keyboard data via MIDI or TO HOST, or when you play the X5 using MIDI data from an external sequencer, 0C POSITION in Global mode determines whether the selected velocity curve is effective or ignored. (see page 147.)

Obtaining After Touch Effects

The X5 does not have an After Touch switch on the keyboard. However, you can control After Touch using the modulation wheel. To do so, set 10A MG WHEEL to After Touch in Global mode. (see page 162.)

When you control the X5 from an external sequencer, send After Touch messages (Channel Pressure messages) to control After Touch effects.

Changing the Note Range of the Keyboard

Use 0B TRANSPOSE in Global mode to change the note range of the keyboard. You can shift the range in semitones: +12 to move up one octave, and -12 to move down one octave. (see page 147.)

Note data sent via MIDI or TO HOST is transposed if 0C POSITION in Global mode is set to After KBD, and it is not transposed if 0C POSITION is set to Before TG. (see page 147.)

If you wish to transpose each Timbre in a Combination individually, use pages 5A and 5B TRANS (see page 99). If you wish to transpose each track in Multi mode, use the Tra parameter on *C page. (see page 108.)

Adjusting Effects While Playing

Select the modulation wheel or the assignable pedal for the EFFECT Dynamic Modulation Control Source parameter to use either device to control effects. (see page 114.)

Changing the Sequence of Programs or Combinations

It is a good idea to sort the Programs or Combinations in the order in which you plan to use them in a live performance. Once you do this, with a single button you can jump to any Program or Combination in the allowable range. (For example, you could lock the [10's HOLD/-] button, or press the switch pedal.)

To change the sequence of Programs or Combinations, use the Program Write function (see page 92) or the Combination Write function (see page 104) to write the Programs or Combinations in the desired order. At this time, the existing destination Programs or Combinations will be lost (overwritten). If you want to keep those Programs or Combinations, first copy them to different Program or Combination numbers.

You can also change the name of Programs and Combinations. (see page 92, 104.)

Changing the Controller Functions in Combinations

You may occasionally want to use different settings for a controller to play Combinations that consist of multiple Programs. For example, you may want the damper pedal to affect only the piano sound if you are playing the piano sound with your right hand and the bass sound with your left, or some similar arrangement. In this case, you can set the damper filter so that particular Timbres will ignore damper operation. Set 6B DAMPER in Combination Edit mode to D (DIS) for each Timbre that you want to ignore the damper effect. (see page 101.)

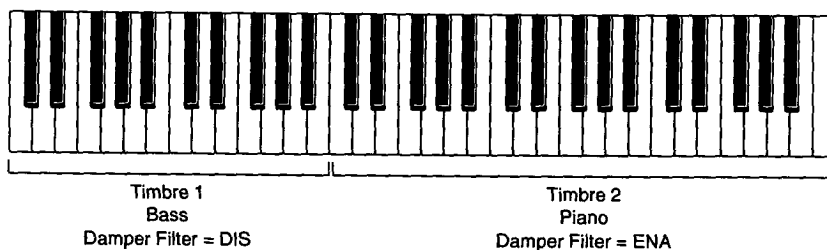

You can set the damper filter parameters for each Track in Multi mode. It is also possible to set whether or not each Timbre or Track accepts After Touch or Control Change messages.

Playing the Keyboard in Split Mode

(Playing Different Sounds With the Left and Right Hands)

If you wish to play different Programs in separate keyboard ranges, such as playing a bass sound with your left hand and a piano sound with your right, set up the Key Window of a Combination. The Key Window allows you to set the note range on the keyboard for each Timbre (see page 97). You can also set the note range using the Key Window in Multi mode. If you wish to play the keyboard in Split mode while you are in Multi mode, first set the MIDI Channel to Global MIDI Channel of the corresponding Tracks, then set each Track's Key Window. (see page 110, 111.)

Selecting a Particular Sound Quickly

Remembering how the sounds in the X5 are sequentially organized will help you select a desirable sound very quickly. For example, Bank G has 128 GM compatible Programs and eight Programs using the Drum Kits, which are each divided into groups that consist of eight sounds.

Remembering the group in which a sound is located will help you select a Program very quickly. This is also helpful when comparing similar types of Program sounds.

It is very convenient to have Bank A Programs and Combinations that are divided into groups and sorted in a desirable order. The default Programs in Bank A have already been divided into groups based on the unit's digit. For example, *1 contains piano and organ sounds, and *9 contains drum and percussion sounds. You can create customized sequences and groups to facilitate operations.

Changing the Function of the Switch Pedal or Volume Pedal

You can change the function of the switch pedal or volume pedal connected to the ASSIGNABLE PEDAL/SWITCH connector using page 9A ASSIGN PDL or 9B ASSIGN SW, respectively, in Global mode. (see page 161.) A volume pedal and switch pedal can have one of the following functions.

Volume Pedal

OFF:	Off (Volume pedal operation does not affect sounds.)
Volume:	Adjusting the volume level (Corresponds to MIDI Volume messages.)
Expression:	Adjusting the volume level (Corresponds to MIDI Expression messages.)
VDF cutoff:	Adjusting tonal brightness (Corresponds to MIDI Brightness messages.)
Effect control:	Adjusting the effects (Dynamic modulation source)
Data entry:	Corresponds to the VALUE slider operation.

Switch Pedal

Damper:	Damper (Hold 1)
Program Up:	Switches to the next Program or Combination number.
Program Down:	Switches to the previous Program or Combination number.
Effect 1 on/off:	Turning Effect 1 on and off.
Effect 2 on/off:	Turning Effect 2 on and off.
Scale Switch:	Changes the scale.

Combining Multiple Programs

In order to play multiple Programs simultaneously, or play different Programs in different note ranges or with different key velocities, assign the Programs to the Timbres in Combination Edit mode and set the Key Window or Velocity Window parameters. (see page 94, 97, 98.)

You can also combine multiple Programs in Multi mode. When you play these on the X5 keyboard, first set the MIDI Channel of the Tracks to the Global MIDI Channel. (see page 111.)

You can combine up to 8 Programs or 16 Multi setup track Programs for a Combination. The X5 can store up to 100 Combinations, but cannot store Multi setup Programs. If you wish to use Multi setup track Programs very often, store them in the Data filer or other storage.

Using a Different Scale

The X5 has various scales as well as an Equal Temperament. You can also create your own scale on page 1A User Scale in Global mode. 1A Scale Type in Global mode is used to set up the main scale you usually use, and 1H Sub Scale is used to set up a sub scale. You can switch between the main scale and the sub scale using a switch pedal connected to the ASSIGNABLE SWITCH connector. (In this case, select "Scale Switch" for the assignable pedal switch function on 9B ASSIGN SW (see page 161). You may also select scales by sending the MIDI Control Change message (Controller #3: Foot Control). A value 0–63 will select the main scale, and a value 64–127 will select the sub scale. You can switch between the main scale and sub scale for each Timbre in Combination Play mode, and for each Track in Multi mode.

Adjusting the Pitch Bend Wheel

10B BEND WHEEL CALIBRATION SET in Global mode allows you to adjust the effective range covered by the pitch bend wheel. (see page 162.)

Adjusting the Modulation Wheel

10C MG WHEEL CALIBRATION SET in Global mode allows you to adjust the effective range of the modulation wheel. (see page 162.)

Editing Applications

Editing the Sounds

Adjust the parameters in Program Edit mode to edit a Program (see page 37). Adjust the parameters in Combination Edit mode to edit a Combination (see page 46). To edit Programs used for Combination Timbres, and Programs used for Tracks in Multi setup, first select the Program you wish to edit in Program Play mode, then enter Program Edit mode.

Copying the Effect Settings

You can copy the effect settings from Programs or Combinations for use in Multi mode or to apply the effect settings of a particular Program to a Combination. Use the Copy Effect function (see page 117) to perform this operation.

Editing the Sound from the Computer

You may edit X5 sounds from a computer using sound editing software. Be certain to use sound editing software that is compatible with the X5 (editing involves MIDI exclusive data in the transmission of sound data). You may also use a sound editor designed for 05R/W; its data is compatible with the X5, except for a few settings in Multi mode and Global mode.

Restoring the Parameter Values to the Factory Settings

To restore edited parameter values to factory default settings, load the default data on page 5A PRESET DATA Load in Global mode (see page 156). It should be noted that this operation will erase all existing data, such as the data of Bank A Programs, Combinations, Drum Kits, and user scales. If necessary, first save the data elsewhere. (see page 155.)

Saving Sound Data

Sound data and settings data can be transmitted as MIDI exclusive data from the X5 to an external sequencer or a data filer that is capable of writing the MIDI exclusive data. Use page 4A MIDI DUMP for transmission (see page 155). You can also send data directly to the computer via the TO HOST connector. The X5 data is compatible with the 05R/W, except for a few parameters.

Set the EX parameter on page 2E MIDI FILTER in Global mode to "ENA" to receive MIDI exclusive data. Otherwise, set this parameter to "DIS."

MIDI Applications

Playing Ensemble from a Sequencer

Enter Multi mode to play ensemble from an external sequencer (that is, to play multiple parts using different Programs simultaneously). (see page 28.) Multi mode of the X5 is used for GM data. You can also use this mode to change the MIDI Channel for each Track, or to adjust the Key Window or Velocity Window settings.

Multi mode is very handy for playing ensemble, although the X5 can play up to eight parts of an ensemble in Combination Play mode by changing the MIDI Channel for each Timbre. It is also possible to copy the Combination parameters into Multi mode. (see page 111.)

Using the X5 as a MIDI Keyboard to Input MIDI Data

To use the X5 as a tone generator or data input keyboard along with a computer, connect the X5 to the computer using special cables or MIDI cables. Note data and Controller data input from the X5 keyboard is output to either the MIDI OUT connector or the TO HOST connector. Select MIDI (MIDI OUT) or PCIF (TO HOST) for 2C EXT OUT SEL in Global mode. (see page 153.)

Controlling the modulation wheel on the X5 transmits MIDI Control messages 0–127 and Aftertouch messages. These messages allow you to control aftertouch, modulation, volume, and pan on the external MIDI devices. Use 10A MG Wheel Select in Global mode to set the related parameters. Refer to the manual of your external MIDI devices for the MIDI information received on these devices.

When the sequencer's echo back is ON (data received at MIDI IN is output from MIDI OUT), set the LOCAL parameter to OFF on page 2B MIDI GLOBAL in Global mode on the X5. This disconnects the X5 keyboard from its tone generator, preventing the X5 from sounding.

- You cannot play the X5 as a stand-alone synthesizer when Local Off is set. Make sure Local is On to play the X5.

Creating a GM Song

When you create a GM song (performance data for a GM-compatible tone generator) using the sequencer and a computer, use only the Programs in Bank G in Multi mode, and use the default settings of the Key Window, Velocity Window, and MIDI Channels (The default setting is obtained by turning the power off and on to the X5 or by executing 23A SET TO GM.) Performance data that uses functions unique to the X5 (such as edits using the effects or Control Change messages) may not be reproduced correctly on a different GM tone generator.

Set and store the Program parameters and level settings on the sequencer. If you wish to set these parameters on the X5 and play back the performance on another X5, you can send the Multi setup data using 4A MIDI Data DUMP in Global mode to the sequencer, and send it back to the X5 to play the data in live performance. (see page 155.)

Useful Tips

The X5 provides you with several useful tips for quicker operation and smoother editing.

Page Memory

The Page Memory function memorizes the most-recently selected page in every mode. Set the Page Memory parameter (3C PAGE MEMORY) in Global mode to ON, and the most-recently selected page in a particular mode will be displayed when you return to that mode (see page 154). This is useful when you wish to return to a different mode during an edit operation, or when you change modes frequently. (The factory default setting is "ON".)

Numeric Keypad

You can use the numeric keypad to specify the value for a parameter directly, as well as to select Programs or Combinations. Enter the number using the numeric keypad, then press the [ENTER] button to enter the parameter value. There are also some parameters for which you can enter a value using only the keypad without pressing the [ENTER] button. Pressing the [10's HOLD/-] button will reverse the sign of the parameter value (minus becomes plus, and vice versa). You can also use the keypad to select a page to edit. Enter the number using the numeric keypad while holding down the [EDIT] button.

[BANK] button

Pressing the [BANK] button in Program Play mode toggles between Banks A and G. If a particular parameter of OSC1 or OSC2 has been selected in Program Edit mode (OSC is set to DOUBLE), pressing the [BANK] button toggles between the same parameters for OSC1 and OSC2. If the Key Window Top, Key Window Bottom, Velocity Window Top, Velocity Window Bottom, Transpose, Detune, or MIDI filter (PROG CHANGE, DAMPER, AFTER TOUCH, CONTROL CHG) parameter has been selected, pressing the [BANK] button will allow you to select its counterpart or related parameter of the same Timbre.

Keyboard Input

Playing a key on the keyboard while pressing and holding the [ENTER] button will allow you to enter the key name parameter (such as Key Window) directly.

When you edit a Drum Kit in Global mode, playing a key while pressing and holding down the [ENTER] button will automatically select the index that is assigned to the corresponding key. However, it should be noted that the key position shifts when the transpose setting is effective or when the Octave parameter is not set to 8'.

Undo

Pressing the [▲/YES] and [▼/NO] buttons simultaneously will undo an edit (that is, it will restore the value of the parameter when it was first selected).

- The Undo function is effective only for the parameter currently selected. When you move the cursor to another parameter, you can no longer restore the previous value.

Chapter 6: Parameter Guide

About This chapter

The following chart shows how the explanations in this chapter are organized.

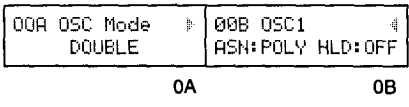
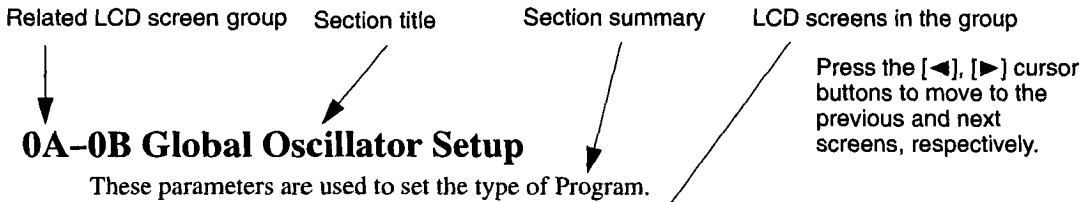

LCD	Parameter	Range	Description
00A	Oscillator Mode (OSC Mode)	SINGLE DOUBLE DRUMS	Oscillator 1 Oscillator1 and Oscillator2 A drum kit
00B	Assign (ASN)	POLY MONO	Polyphonic Monophonic
	Hold (HLD)	ON/OFF	Note hold after key release (set to ON for DRUMS mode)

LCD screen or function button numbers.

Parameters on each LCD screen
The characters in parentheses () are shown on the screen.

Parameter range or available settings
The left-most value or the value on the upper line is obtained when you lower the VALUE slider to the bottom or when you press and hold down the [▼/NO] button.

Brief description. A full description is provided in the text below each parameter table.

MIDI Data Values

In general, decimal values are used throughout this *Owner's Manual*. Numbers that are enclosed by square brackets are hexadecimal.

Program Parameters

Functions in Program Mode

To select a page, use the [PAGE+] or [PAGE-] button, or enter the page number directly from the numeric keypad while holding down the [EDIT] button. To select a parameter, use the [◀], [▶] cursor buttons. To set a parameter value, use the [▲/YES] and [▼/NO] buttons, or the [VALUE] slider, or enter the value directly from the numeric keypad while holding down the [ENTER] button. For some parameters, you can enter the number only from the number keypad to set the value. To enter a note value, play the corresponding key while pressing the [ENTER] button. If a parameter of OSC1 or OSC2 has been selected (OSC is set to DOUBLE), pressing the [BANK] button toggles between the same parameters for OSC1 and OSC2.

Page numbers shown in the upper left corner of the screens in Single or Drums mode are different from those in Double mode. This manual uses the page examples in Double mode.

Page		Function	Parameters
SINGLE, DRUMS	DOUBLE		
0A-0B	0A-0B	OSC Mode	Oscillator mode
		Assign/Hold	Number of voices to sound, and Hold settings
1A-1D	1A-1D	OSC1 Multi Sound (Drum Kit) Level/Octave	Oscillator 1 waveform Level, Octave Double mode only
		EG Intensity/Pan/Send	Depth of the pitch change over time, output destination
—	2A-2F	OSC2 Multi Sound Level/Octave EG Intensity/Pan/Send Interval/Detune Delay	Refer to the OSC1 parameters. Interval (by semitone) and detune (by cent) relative to OSC1 Delay in sounding OSC2 relative to OSC1
2A-2C	3A-3C	Pitch EG	Adjusts changes in pitch over time
3A-3E	4A-4E	VDF1 Cutoff EG Color	VDF1 cutoff frequency (Controls brilliance of tone) Specifies changes in cutoff frequency over time. Color (feedback effect)
4A-4E	5A-5E	VDF1 Velocity Sense Keyboard Tracking	How key velocity affects VDF1 EG cutoff frequency and time How key position affects VDF1 EG cutoff frequency and time
—	6A-6E	VDF2 Cutoff EG Color	Refer to the VDF1 parameters.
—	7A-7E	VDF2 Velocity Sense Keyboard Tracking	Refer to the VDF1 parameters.
5A-5C	8A-8C	VDA1 EG	Change in VDA1 level over time
6A-6E	9A-9E	VDA1 Velocity Sense Keyboard Tracking	How key velocity affects VDA1 EG cutoff frequency and time How key position affects VDA1 EG cutoff frequency and time
—	10A-10C	VDA2 EG	Refer to VDA1 parameters.
—	11A-11E	VDA2 Velocity Sense Keyboard Tracking	Refer to VDA1 parameters.
7A-7E	12A-12E	Pitch1 MG	Oscillator 1 pitch MG (vibrato)
—	13A-13E	Pitch2 MG	Oscillator 2 pitch MG (vibrato)
8A-8C	14A-14C	VDF MG	VDF modulation (wah-wah effect)
9A-9D	15A-15D	After Touch Control Joy Stic Control	After Touch control Pitch bend/modulation wheel
10A-15A	16A-20A	Effect	Effect settings
16A-16B	22A-22B	Program Write Rename Program	Writes a Program Renames a Program

- ② Double mode only
- For information on Effects, See “Effect Parameters” on page 113.

0A–0B Global Oscillator Setup

These parameters are used to select a basic Program type—that is, whether the Program will use a single oscillator, two oscillators, or a drum kit. In addition, you can specify whether the Program will hold notes even after Note Off messages are received, and whether it will play monophonically or polyphonically.

00A OSC Mode DOUBLE	00B OSC1 ASN:POLY HLD:OFF
0A	0B

LCD	Parameter	Range	Description
0A	Oscillator Mode (OSC Mode)	SINGLE DOUBLE DRUMS	Oscillator1 Oscillator1 and Oscillator2 A drum kit
0B	Assign (ASN)	POLY MONO	Polyphonic (Chords) Monophonic (Single tone)
	Hold (HLD)	ON/OFF	Note hold after key release (set to ON for DRUMS mode)

0A Oscillator mode: there are three Oscillator modes: Single, Double, and Drums. If you have changed Oscillator mode, go to page 1A to select a Multisound or Drum Kit. In Single mode, only Oscillator1 is used, and 64-note polyphony is available on the X5D, and 32-note polyphony on the X5. In Double mode, Oscillator1 and Oscillator2 are used, and different Multisounds can be selected for each oscillator, each with independent VDF and VDA. Polyphony is 32 notes on the X5D, and 16 notes on the X5.

0B Assign: this parameter sets the Program to either polyphonic or monophonic. In Polyphonic mode, a number of notes up to the maximum available can be played simultaneously. In Monophonic mode, one note only can be played at a time.

Hold: this parameter determines whether or not notes continue to sound even after the corresponding MIDI Note Off message has been received. That is, even after keys are released. Typically, this parameter should be set to off, unless you want notes to drone on for eternity. However, when the Oscillator mode is set to DRUMS, this parameter should be set to ON. This will ensure that drum sounds are played in their entirety regardless of MIDI Note length or how long you hold down a key.

1A-1D Oscillator1 Setup

These parameters are used to select the waveform for Oscillator1 and to set up other parameters related to this oscillator.

If 0A Oscillator Mode has been set to DOUBLE, pressing the [BANK] button will take you to parameters 2A-2D.

01A OSC1 SOUND ▸ 000:A.Piano 1	01B OSC1 Level199 OCT 8'	01C OSC1 EGint+00 Pan=CNT	01D OSC1 C/D SEND= 5 : 5
1A	1B	1C	1D

LCD	Parameter	Range	Description
1A	Multisound (SOUND)	0-429 (X5D) 0-339 (X5) 0-9	Multisounds (Single/Double mode) If Oscillator mode is DRUMS, select a drum kit
1B	Oscillator Level (Level)	0-99	Level
	Octave (OCT)	32' 16' 8' 4'	2 octaves down 1 octave down Normal pitch 1 octave up
1C	Pitch EG Intensity (EGint)	-99...+99	The amount of control that the Pitch EG exerts over pitch
	Pan (Pan)	OFF, A15-CNT-B15	Output pan to buses A and B (when Osc mode = Single or Double on)
1D	Send C	0-9	Output level to bus C
	Send D	0-9	Output level to bus D

- 1A Multisound:** this parameter is used to select an internal Multisounds for Oscillator1. The X5D has 430 Multisounds and the X5 has 340 Multisounds. Multisounds are the basic sound elements that make up a Program and provide the basic characteristics of a Program.

Multisounds with NT (No Transpose) at the end of their names, for example, 187 Stadium NT, produce the same pitch regardless of what note is played.

Note: Since each Multisound has an upper limit to its pitch range, some Multisounds may not produce sound when high notes are played.

In Drum mode, a drum kit is used instead of a Multisound.

If the Oscillator mode 0A is set to DRUMS, you can select a drum kit from the following table. Drum kits are set up in Global mode. "6A-6D Drum Kit1 Setup" on page 158 and "7A-7D Drum Kit2 Setup" on page 160.

Range	Drum Kit	Bank
0	Drum Kit 1	Internal RAM
1	Drum Kit 2	
2	Rom D.Kit1	ROM
:	:	
9	Rom D.KitB	

Drum maps for drum kits 0, 1 and 2-9 are provided at the back of this Owner's Manual.

- 1B Oscillator Level:** this parameter is used to set the volume level of Oscillator1.

Note: For some Multisounds, a high Oscillator Level may result in distortion when playing chords. If this occurs, reduce the Oscillator Level.

Octave: this parameter allows you to shift a Multisound up or down in one octave steps. If the Oscillator mode 0A is set to DRUMS, this parameter should be set to 8', otherwise some drum sounds will be moved out of their playable range. If this parameter is set to anything other than 8', take care when setting the VDA and VDF Keyboard Tracking parameters.

- 1C Pitch EG Intensity:** this parameter determines the amount of control that the Pitch EG exerts over the pitch of Oscillator1. A negative value inverts the pitch levels set for the Pitch EG (Refer to 3A–3C Pitch EG.).

Pan: this parameter is used to pan the output of Oscillator1 between buses A and B. These buses feed the effects processors. See “20A–20B Effect Placement” on page 115. When OFF is selected, no signals are sent on buses A and B. The CNT setting means center; signals of equal level are fed to buses A and B.

Note: When the Oscillator mode 0A is set to DRUMS, the pan settings for each drum in the kit are used, and this parameter does not appear. See “6A–6D Drum Kit1 Setup” on page 158 and “7A–7D Drum Kit2 Setup” on page 160.

Note: Some Multisounds on the X5D have their own Pan settings and will ignore the Pan settings here, indicating “Pan=---.”

- 1D Send C, Send D:** these parameters are used to set the level of the Oscillator1 signals sent to buses C and D. These buses feed the effects processors. See “20A–20B Effect Placement” on page 115.

Note: If 0A Oscillator mode is set to DRUMS, these parameters are multiplied by the settings for each drum in the kit, then output to Send C and Send D. See “6A–6D Drum Kit1 Setup” on page 158 and “7A–7D Drum Kit2 Setup” on page 160.

2A–2F Oscillator2 Setup

These parameters are used to select the waveform for Oscillator2 and to set up other parameters related to this oscillator. These parameters are available only when the Oscillator mode is set to DOUBLE. See “1A–1D Oscillator1 Setup” on page 71.

02A OSC2 SOUND ▸ 000:A.Piano 1	02B OSC2 ▮ Level199 OCT16'	02C OSC2 ▮ EGint+00 Pan=CNT	02D OSC2 ▮ C/D SEND= 5 : 5	02E OSC2 SOUND ▮ Intvl+00 Detn+03	
2A	2B	2C	2D	2E	
<table border="1" style="width: 100%;"> <tr> <td>02F OSC2 ▮ Delay=00</td> </tr> </table>					02F OSC2 ▮ Delay=00
02F OSC2 ▮ Delay=00					
2F					

LCD	Parameter	Range	Description
2A	Multisound (SOUND)	0–429 (X50) 0–339 (X5)	Select Multisounds
2B	Oscillator Level (Level)	0–99	Oscillator2 level
	Octave (OCT)	32' 16' 8' 4'	2 octaves down 1 octave down Normal pitch 1 octave up
2C	Pitch EG Intensity (EGint)	–99...+99	The amount of control that the Pitch EG exerts over pitch
	Pan (Pan)	OFF, A15–CNT–B15	Output pan to buses A and B
2D	Send C	0–9	Output level to bus C
	Send D	0–9	Output level to bus D
2E	Interval (Intvl)	–12...+12	Pitch shift relative to Oscillator1
	Detune (Detn)	–50...+50	Oscillator1 and Oscillator2 detune
2F	Delay Start (Delay)	0–99	Oscillator2 sound output delay relative to Oscillator1

Apart from the fact that they control Oscillator2, parameters 2A–2D work the same as they do for Oscillator1. See “1A–1D Oscillator1 Setup” on page 71. The following parameters, however, 2E and 2F, apply to Oscillator2 only.

2E Interval: this parameter pitch shifts Oscillator2 relative to Oscillator1 in semitone steps. This can be used, for example, to form simple 2-note chords.

Detune: this parameter de-tunes oscillators 1 and 2. This is useful for creating a thicker, richer sound. For a positive (+) Detune value, the pitch of Oscillator1 is lowered and the pitch of Oscillator2 is raised. For a negative (–) Detune value, the pitch of Oscillator1 is raised and the pitch of Oscillator2 is lowered. In other words, as the Detune value is increased, both oscillators are detuned by the same amount, but in opposite directions. Odd Detune values will lower and raise oscillator pitches in half cent steps.

Detune	Oscillator1	Oscillator2
+50	–25	+25
+25	–12.5	+12.5
0	0	0
–12	+6	–6
–50	+25	–25

2F Delay Start: this parameter allows you to set Oscillator2 so that it starts producing sound after Oscillator1. A setting of 0 means no delay. This is normally set to 0.

3A–3C Pitch EG

These parameters determine how the pitches of Oscillator1 and Oscillator2 vary over time.

03A PITCH EG SL+00 AT00 AL+00	03B PITCH EG DT00 RT00 RL+00	03C PTCH. EG Vel Levl=99 Tim=+00
3A	3B	3C

LCD	Parameter	Range	Description
3A	Start Level (SL)	-99...+99	Amount of pitch change when key is first pressed
	Attack Time (AT)	0-99	Time to reach Attack level pitch when key pressed
	Attack Level (AL)	-99...+99	Amount of pitch change when attack time ends
3B	Decay Time (DT)	0-99	Time to reach normal pitch once attack time ends
	Release Time (RT)	0-99	Time to reach Release level pitch when key is released
	Release Level (RL)	-99...+99	Amount of pitch change when key is released
3C	EG Level Velocity Sensitivity (Levl)	-99...+99	Pitch EG level sensitivity to keyboard velocity
	EG Time Velocity Sensitivity (Tim)	-99...+99	Pitch EG time sensitivity to keyboard velocity

The Pitch EG can change the oscillator pitch by up to ± 1 octave. A level setting of 99 is approximately 1 octave. The extent to which the Pitch EG affects the oscillator pitch is set independently for each oscillator using the Pitch EG Intensity (EGint) parameters. See “1A–1D Oscillator1 Setup” on page 71 and “2A–2F Oscillator2 Setup” on page 73.

The main thing to remember is that the Level parameters specify the amount of pitch change, and the time parameters specify the time it takes to reach pitch changes relative to note on and note off. Negative (-) levels mean lowered pitch and positive (+) levels mean raised pitch.

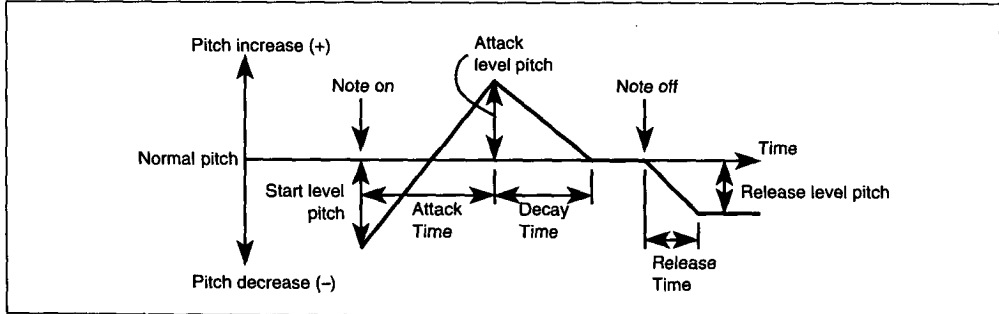

3C EG Level Velocity Sensitivity: this parameter allows you to control the Pitch EG pitch levels using note velocity. For a positive value (+), the amount of pitch change will increase as note velocity increases. A negative value (-) will have the opposite effect.

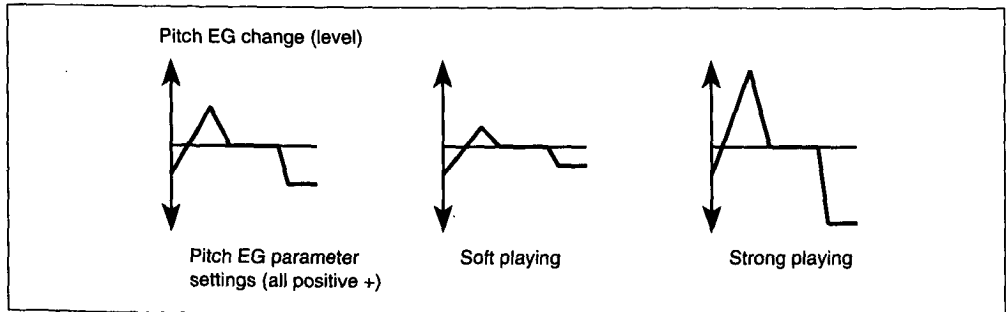

EG Time Velocity Sensitivity: this parameter allows you to control the Pitch EG Time parameters using note velocity. For a positive value (+), time parameters will become shorter as note velocity increases. A negative value (-) will have the opposite effect.

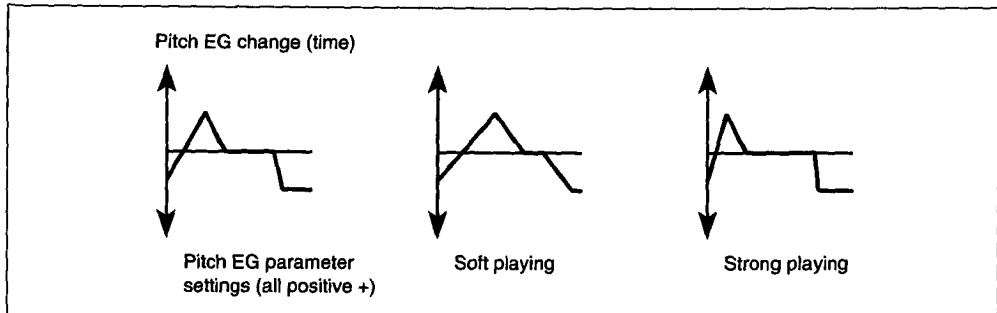

4A–4E VDF1 Cutoff, EG & Color

These parameters are used to set up the VDF (Variable Digital Filter) for Oscillator1.

04A VDF 1 Fc=19 EGint=65	04B VDF1 EG AT09 AL+08 DT00	04C VDF1 EG BP+00 ST00 SL+00	04D VDF1 EG RT00 RL+00	04E COLOR1 Int=00 Vel=+00
4A	4B	4C	4D	4E

LCD	Parameter	Range	Description
4A	VDF Cutoff Frequency (Fc)	0–99	Cutoff frequency
	EG Intensity (EGint)	0–99	The amount of control that the following EG parameters exert over the VDF Cutoff Frequency parameter
4B	Attack Time (AT)	0–99	Time to reach Attack Level after key pressed
	Attack Level (AL)	–99...+99	Amount of Cutoff Frequency change when Attack Time ends
	Decay Time (DT)	0–99	Time to reach Break Point once Attack Time ends
4C	Break Point (BP)	–99...+99	Amount of Cutoff Frequency change when Decay Time ends
	Slope Time (ST)	0–99	Time to reach Sustain Level once Decay Time ends
	Sustain Level (SL)	–99...+99	Amount of Cutoff Frequency change until key released
4D	Release Time (RT)	0–99	Time to reach Release Level when key released
	Release Level (RL)	–99...+99	Amount of Cutoff Frequency change once Release Time ends
4E	Color Intensity (Int)	0–99	Amount of color
	Color Velocity (Vel)	–99...+99	Color sensitivity to keyboard velocity

This VDF is basically a low-pass filter with a variable Cutoff Frequency parameter. It can be used to change the tonal quality of a Program. The VDF EG (Variable Digital Filter Envelope Generator) parameters allow you to determine how the Cutoff Frequency changes over time.

- 4A VDF Cutoff Frequency:** the Cutoff Frequency can be set from 0 to 99. As the value is reduced, high frequencies are filtered, thus producing a duller (softer) tone.

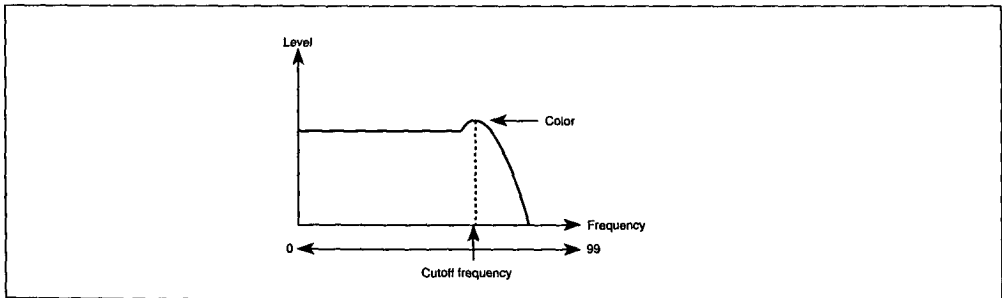

EG Intensity: this parameter determines the amount of control that the VDF EG exerts over the VDF Cutoff Frequency parameter. Basically, it sets the overall level of the VDF EG.

- 4B–4D VDF EG:** the eight parameters on LCD screens 4B to 4D are used to set up the VDF EG. Level parameters specify the amount of VDF Cutoff Frequency change, and time parameters specify the time it takes to reach Cutoff Frequency changes relative to note on and note off. Positive values cause the Cutoff Frequency to increase, negative values cause it to decrease.

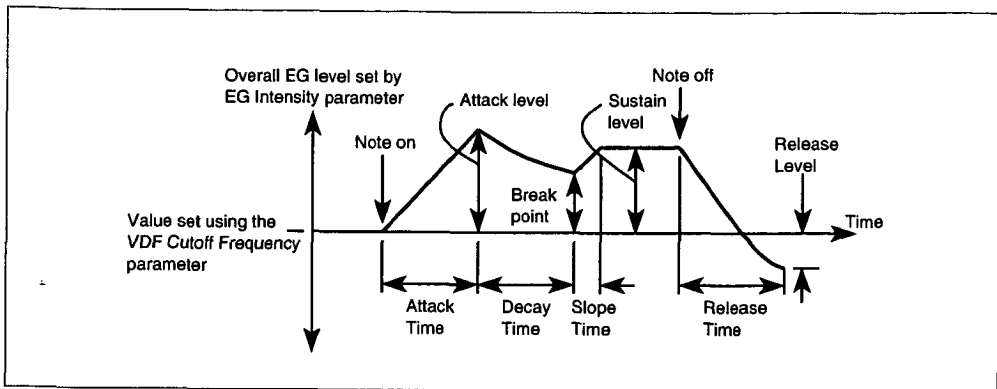

- 4E Color Intensity:** By boosting the level around the Cutoff Frequency, the Color parameter adds character to a sound.

Color Velocity: this parameter determines how the color parameter responds to note velocity. For positive values, stronger playing will increase the amount of color. Negative values will have the opposite effect.

5A–5E VDF1 Velocity Sensitivity & Keyboard Tracking

VDF1 Velocity Sensitivity parameters determine how VDF1 EG responds to note velocity. The Keyboard Tracking parameters determine how different areas of the keyboard affect VDF1.

05A VDF1 V.SENS+ EGint+77 EGtm00	05B VDF1 V.SENS+ AT0 DT0 ST0 RT0	05C VDF1 K.TRK # KeyF#4 Mode=ALL	05D VDF1 K.TRK # Int=+00 EGtm=00	05E VDF1 K.TRK # AT0 DT0 ST0 RT0
5A	5B	5C	5D	5E

LCD	Parameter	Range	Description
5A	Velocity Sensitivity EG Intensity (EGint)	-99...+99	VDF1 EG Intensity parameter sensitivity to keyboard velocity
	Velocity Sensitivity EG Time (EGtm)	0-99	VDF1 EG Time parameter sensitivity to keyboard velocity
5B	Attack Time (AT)	-, 0, +	The direction in which VDF1 EG Time parameters are affected by keyboard velocity
	Decay Time (DT)	-, 0, +	
	Slope Time (ST)	-, 0, +	
	Release Time (RT)	-, 0, +	
5C	Keyboard Tracking Key (Key)	C-1 to G9	For Low and High keyboard tracking modes, the key from which keyboard tracking starts. For All mode, the key at which VDF Cutoff Frequency and VDF EG Time parameters are not affected
	Keyboard Tracking Mode (Mode)	OFF LOW HIGH ALL	No keyboard tracking Keyboard tracking below the specified key Keyboard tracking above the specified key Keyboard tracking over the entire keyboard
5D	Keyboard Tracking Intensity (Int)	-99...+99	VDF1 cutoff to keyboard tracking
	Keyboard Tracking EG Time (EGtm)	0-99	VDF1 EG Time parameter sensitivity to keyboard tracking
5E	Attack Time (AT)	-, 0, +	The direction in which VDF1 EG Time parameters are affected by keyboard tracking
	Decay Time (DT)	-, 0, +	
	Slope Time (ST)	-, 0, +	
	Release Time (RT)	-, 0, +	

Note: Some of the parameters mentioned in this section operate in conjunction with parameters in "4A–4E VDF1 Cutoff, EG & Color" on page 76, so refer to that section also.

- 5A Velocity Sensitivity EG Intensity:** this parameter determines how the VDF1 EG Intensity parameter is affected by note velocity. For positive values, soft playing will reduce the value of the VDF1 EG Intensity parameter, strong playing will increase the value. Negative values will have the opposite effect.

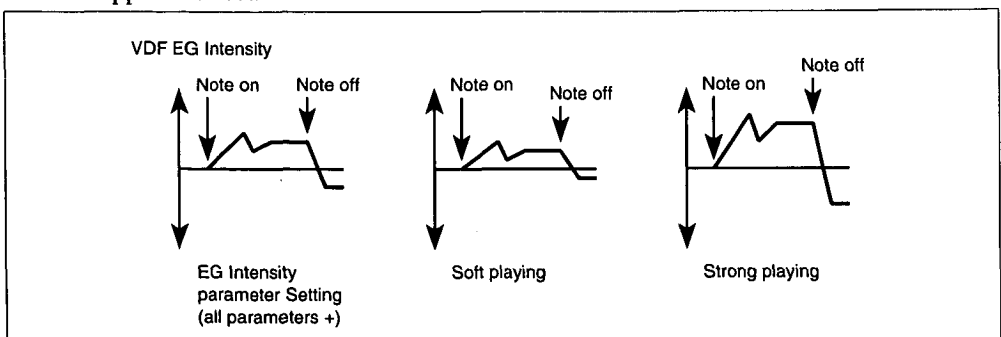

Many acoustic instruments often produce less high-frequency energy when played softly. Soft playing produces a darker sound, while strong playing creates many high frequency harmonics that brighten the sound. This natural phenomenon can be simulated by setting the VDF Cutoff Frequency parameter to a fairly low value, and the VDF EG Intensity, VDF EG Sustain Level, and Velocity Sensitivity EG Intensity parameters to positive values.

Note: This parameter does not affect the VDF Cutoff Frequency parameter directly, it affects the EG Intensity parameter. So if the EG Intensity parameter, or all other VDF EG parameters are set to 0, it will have no effect.

Velocity Sensitivity EG Time: this parameter determines how the VDF1 EG Time parameters are affected by note velocity. It affects the VDF1 EG Attack, Decay, Slope, and Release Time parameters equally. Although, the direction of change can be set independently for each parameter.

5B Attack, Decay, Slope, Release Times: these parameters determine whether the VDF1 EG Time parameters are reduced or increased with changing note velocity. For a negative (-) value, they are increased, for a positive (+) value reduced. A setting of 0 means no effect. In the following illustration, each parameter is set to positive.

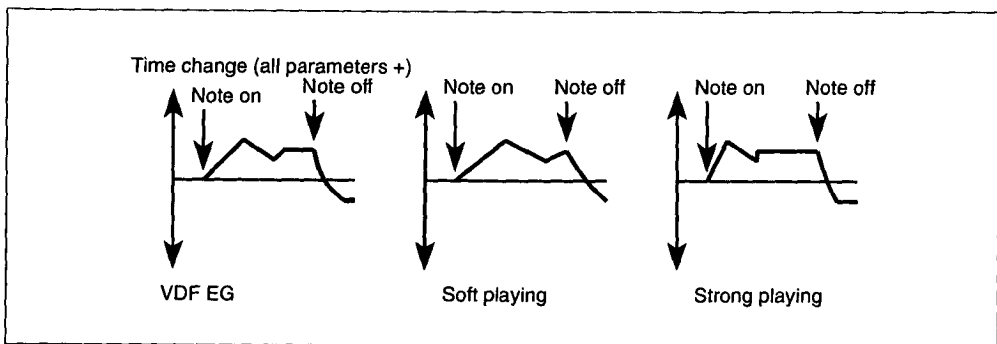

5C Keyboard Tracking Key: for Low and High keyboard tracking modes, this parameter specifies the key from which keyboard tracking starts. For All mode, it specifies the key around which keyboard tracking will take place. At the specified key, keyboard tracking will have no effect.

The tracking key can be set by pressing a keyboard key while holding down the [ENTER] button. Refer to "Keyboard Input" on page 67.

Keyboard Tracking Modes: keyboard tracking determines how the VDF affects different areas of the keyboard. There are four Keyboard Tracking modes: Off, Low, High, and All. When Off is selected, there is no keyboard tracking and the Keyboard Tracking Intensity and Keyboard Tracking EG Time parameters are disabled. When Low is selected, keyboard tracking is active on keys below the specified Keyboard Tracking Key. When High is selected, keyboard tracking is active on keys above the specified Keyboard Tracking Key. When All is selected, keyboard tracking will be active across the entire keyboard.

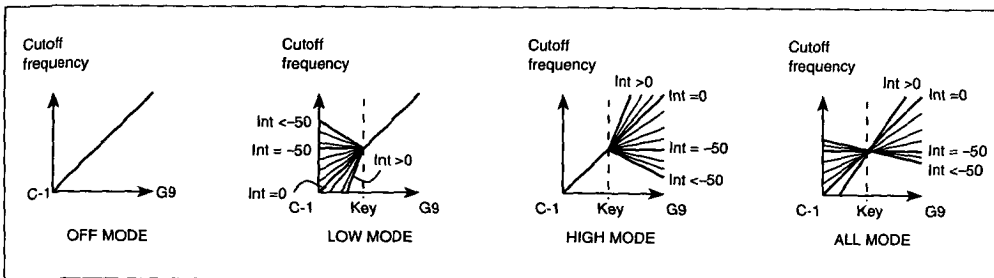

5D Keyboard Tracking Intensity: this parameter determines keyboard tracking intensity for the specified keyboard area. Positive values will make high notes brighter. Negative values have the opposite effect. For a value of 0, the Cutoff Frequency changes linearly with regard to key pitch. For a value of -50, the Cutoff Frequency is the same for all notes.

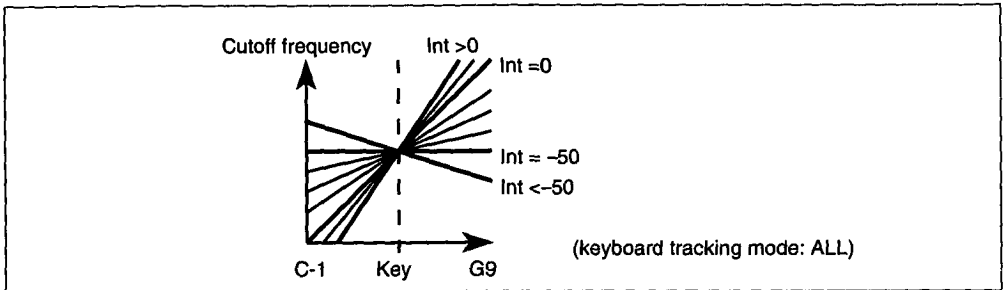

Keyboard Tracking EG Time: this parameter determines how the VDF1 EG Time parameters are affected by keyboard tracking. It affects the VDF1 EG Attack, Decay, Slope, and Release Time parameters equally. Although, the direction of change can be set independently for each parameter. The Keyboard Tracking mode and Key parameters can be used to specify the keyboard area that is affected.

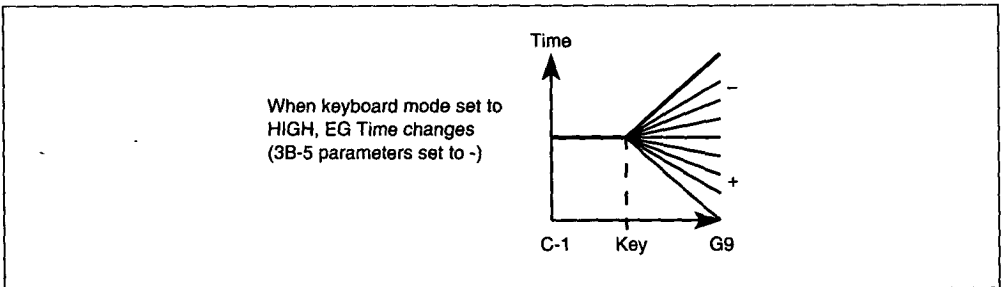

5E Attack, Decay, Slope, Release Times: these parameters determine whether the VDF1 EG Time parameters are reduced or increased with keyboard tracking. For a negative (-) value, notes above the specified key will have their VDF EG times increased. For a positive (+) value, notes above the specified key will have their VDF EG times decreased. A setting of 0 means no effect.

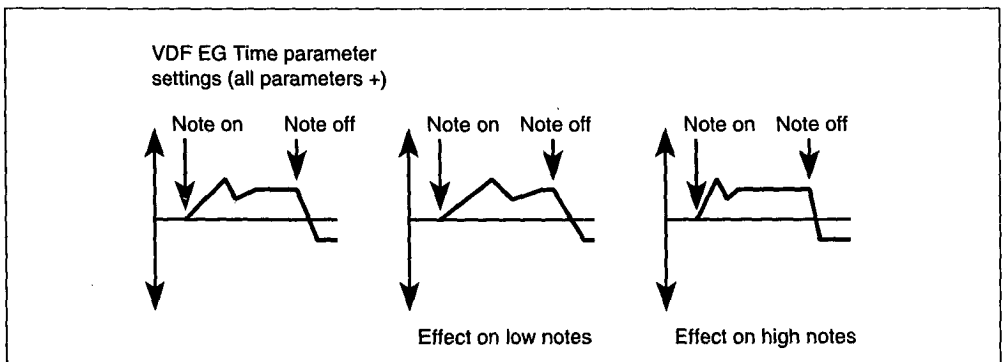

6A–6E VDF2 Cutoff, EG & Color

These parameters are used to set up the VDF (Variable Digital Filter) for Oscillator2. Operation is the same as for VDF1. See “4A–4E VDF1 Cutoff, EG & Color” on page 76.

06A VDF 2 Fc=19 EGint=65	06B VDF2 EG AT09 AL=08 DT00	06C VDF2 EG BP+00 ST00 SL+00	06D VDF2 EG RT00 RL+00	06E COLOR2 Int=00 Uel=+00
6A	6B	6C	6D	6E

7A–7E VDF2 Velocity Sense & Keyboard Tracking

VDF2 Velocity Sensitivity parameters determine how VDF2 EG responds to note velocity. The Keyboard Tracking parameters determine how different areas of the keyboard affect VDF2.

Operation is the same as for VDF1. See “5A–5E VDF1 Velocity Sensitivity & Keyboard Tracking” on page 78.

07A VDF2 U.SENS# EGint+77 EGtm00	07B VDF2 U.SENS# AT0 DT0 ST0 RT0	07C VDF2 K.TRK # KeyF#4 Mode=ALL	07D VDF2 K.TRK # Int=+00 EGtm=00	07E VDF2 K.TRK # AT0 DT0 ST0 RT0
7A	7B	7C	7D	7E

8A-8C VDA1 EG

VDA1 EG (Variable Digital Amplifier Envelope Generator) determines how the volume of Oscillator1 varies over time.

08A VDA1 EG	08B VDA1 EG	08C VDA1 EG
AT00 AL99 DT15	BP20 ST80 SL00	RT60
8A	8B	8C

LCD	Parameter	Range	Description
8A	Attack Time (AT)	0-99	Time to reach Attack Level after key pressed
	Attack Level (AL)	0-99	Volume level when Attack Time ends
	Decay Time (DT)	0-99	Time to reach Break Point once Attack Time ends
8B	Break Point (BP)	0-99	Volume level when Decay Time ends
	Slope Time (ST)	0-99	Time to reach Sustain Level once Decay Time ends
	Sustain Level (SL)	0-99	Volume level when Slope Time ends
8C	Release Time (RT)	0-99	Time to reach zero volume when key released

The following illustration shows how the VDA1 EG parameters affect the VDA (Variable Digital Amplifier).

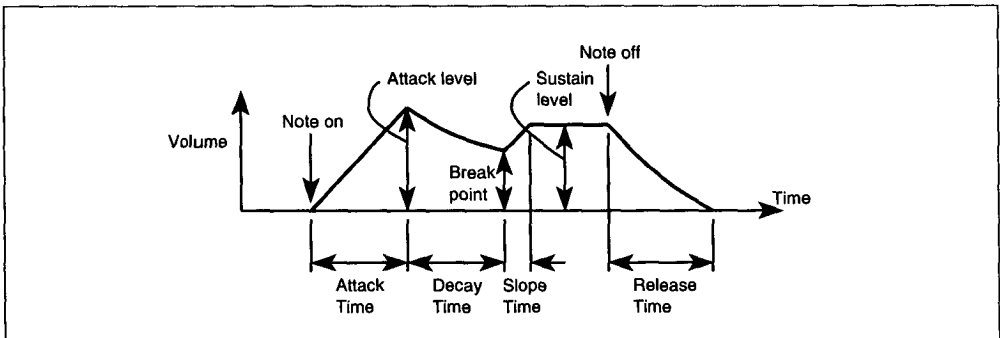

9A–9E VDA1 Velocity Sensitivity & Keyboard Tracking

VDA1 Velocity Sensitivity parameters determine how VDA1 EG responds to note velocity. The Keyboard Tracking parameters determine how different areas of the keyboard affect VDA1.

09A VDA1 V.SENS# AMP=+99 EGtm=00	09B VDA1 V.SENS# AT0 DT0 ST0 RT0	09C VDA1 K.TRK # KeyC#1 Mode=OFF	09D VDA1 K.TRK # AMP=+00 EGtm=00	09E VDA1 K.TRK # AT0 DT0 ST0 RT0
9A	9B	9C	9D	9E

LCD	Parameter	Range	Description
9A	Velocity Sensitivity Amplitude (Amp)	-99...+99	VDA1 EG sensitivity to note velocity
	Velocity Sensitivity EG Time (EGtm)	0-99	VDA1 EG Time parameter sensitivity to note velocity
9B	Attack Time (AT)	-, 0, +	The direction in which VDA1 EG Time parameters are affected by note velocity
	Decay Time (DT)	-, 0, +	
	Slope Time (ST)	-, 0, +	
	Release Time (RT)	-, 0, +	
9C	Keyboard Tracking Key (Key)	C-1 to G9	For Low and High keyboard tracking modes, the key from which keyboard tracking starts. For All mode, the key at which VDA1 EG parameters are not affected
	Keyboard Tracking Mode (Mode)	OFF LOW HIGH ALL	No keyboard tracking Keyboard tracking below the specified key Keyboard tracking above the specified key Keyboard tracking over the entire keyboard
9D	Keyboard Tracking Amplitude (Amp)	-99...+99	VDA1 EG sensitivity to keyboard tracking
	Keyboard Tracking EG Time (EGtm)	0-99	VDA1 EG Time parameter sensitivity to keyboard tracking
9E	Attack Time (AT)	-, 0, +	The direction in which VDA1 EG Time parameters are affected by keyboard tracking
	Decay Time (DT)	-, 0, +	
	Slope Time (ST)	-, 0, +	
	Release Time (RT)	-, 0, +	

Note: Some of the parameters mentioned in this section operate in conjunction with parameters in "8A–8C VDA1 EG" on page 82, so refer to that section also.

9A Velocity Sensitivity Amplitude: this parameter determines how the overall level of VDA1 EG is affected by note velocity. For positive values, soft playing will reduce the volume. For negative values will increase the volume. In the following illustration, a positive value has been selected.

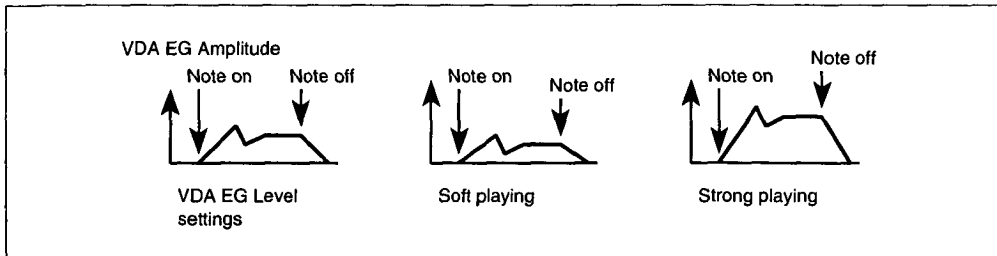

By setting the Velocity Sensitivity Amplitude parameter for VDA1 to a positive value and the Velocity Sensitivity Amplitude parameter for VDA2 to a negative value, a velocity crossfade effect can be achieved. This allows you to fade between two sounds as your playing changes from soft to strong and vice versa.

Velocity Sensitivity EG Time: this parameter determines how the overall level of VDA1 EG time parameters are affected by note velocity. It affects the VDA1 EG Attack, Decay, Slope, and Release Time parameters equally. Although, the direction of change can be set independently for each parameter.

- 9B Attack, Decay, Slope, Release Times:** these parameters determine whether the VDA1 EG time parameters (9A) are reduced or increased with changing note velocity. For a negative (-) value, they are increased the stronger you play, for a positive (+) value they are reduced the stronger you play. In other words, for a positive setting, the stronger you play, the shorter the Attack, Decay, Slope, and Release times become. This is especially effective on string type Programs. In the following illustration, all parameters are set to positive.

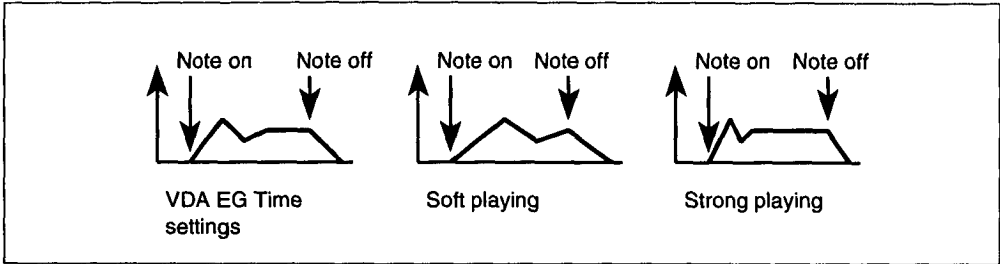

- 9C Keyboard Tracking Key:** for Low and High keyboard tracking modes, this parameter specifies the key from which keyboard tracking starts. For All mode, it specifies the key around which keyboard tracking will take place. At the specified key, keyboard tracking will have no effect.

The tracking key can be set by pressing a key while holding down the X5 [ENTER] button. Refer to “Keyboard Input” on page 67.)

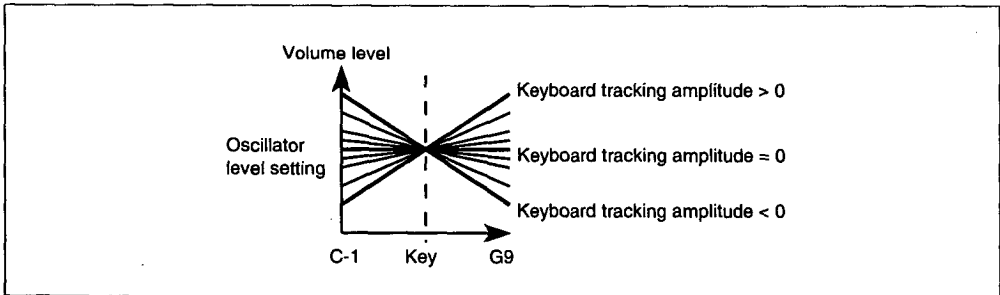

Keyboard Tracking Modes: keyboard tracking determines how the VDA EG applies to different areas of a keyboard. There are four Keyboard Tracking modes: Off, Low, High, and All. When Off is selected, there is no keyboard tracking and the Keyboard Tracking Amplitude and Keyboard Tracking EG Time parameters are disabled. When Low is selected, keyboard tracking is active on keys below the specified Keyboard Tracking Key. When High is selected, keyboard tracking is active on keys above the specified Keyboard Tracking Key. When All is selected, keyboard tracking is active across the entire keyboard.

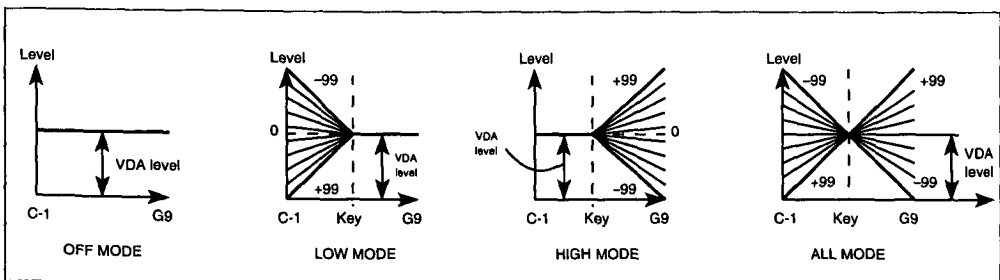

9D Keyboard Tracking Amplitude: this parameter determines keyboard tracking amplitude for the specified keyboard area. Positive values make high notes louder. Negative values have the opposite effect.

Keyboard Tracking EG Time: this parameter determines how the overall level of the VDA1 EG time parameters are affected by keyboard tracking. It affects the VDA1 EG Attack, Decay, Slope, and Release time parameters equally. Although, the direction of change can be set independently for each parameter. The Keyboard Tracking mode and Key parameters can be used to specify the keyboard area that is affected.

9E Attack, Decay, Slope, Release Times: these parameters determine whether the VDA1 EG Time parameters are reduced or increased with keyboard tracking. For a negative (-) value, notes above the specified key have their VDA EG times increased. For a positive (+) value, notes above the specified key have their VDA EG times decreased. In the following illustration, all parameters are set to positive.

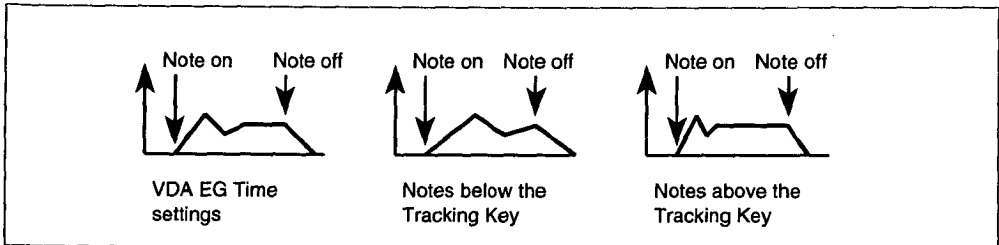

Creating a Positional Crossfade

You can specify a keyboard position at which one oscillator will fade out and the other will fade in. Set VDA1 (9C) and VDA2 (11C) to the same Keyboard Tracking Key, for example, C4, then set VDA1 (9D) to a positive Keyboard Tracking Amplitude value and VDA2 (11D) to a negative Keyboard Tracking Amplitude value. The following illustration shows this more clearly.

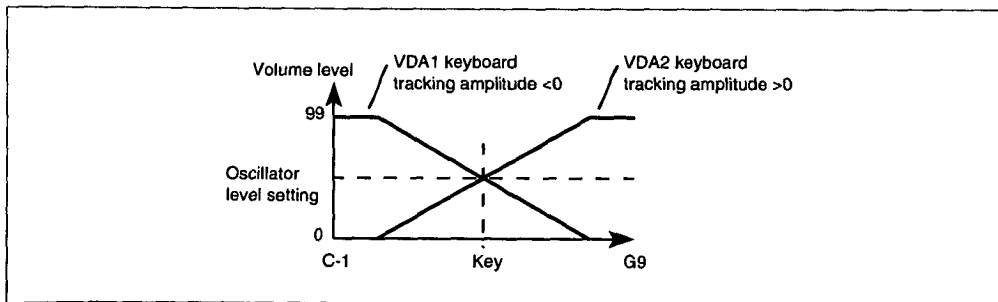

10A–10C VDA2 EG

VDA2 EG (Variable Digital Amplifier Envelope Generator) determines how the volume of Oscillator2 varies over time. Operation is the same as for VDA1. See “8A–8C VDA1 EG” on page 82.

10A VDA2 EG AT00 AL99 DT15	10B VDA2 EG BP20 ST88 SL00	10C VDA2 EG RT60
10A	10B	10C

11A–11E VDA2 Velocity Sensitivity & Keyboard Tracking

VDA2 Velocity Sensitivity parameters determine how VDA2 EG responds to note velocity. The Keyboard Tracking parameters determine how different areas of the keyboard affect VDA2 EG. Operation is the same as for VDA1. See “9A–9E VDA1 Velocity Sensitivity & Keyboard Tracking” on page 83.

11A VDA V.SENS AMP=+99 EGTm=00	11B VDA2 V.SENS AT0 DT0 ST0 RT0	11C VDA2 K.TRK KeyC#1 Mode=OFF	11D VDA2 K.TRK AMP=+00 EGTm=00	11E VDA2 K.TRK AT0 DT0 ST0 RT0
11A	11B	11C	11D	11E

12A–12E Pitch1 Modulation

These parameters allow you to modulate the pitch of Oscillator1. Modulation frequency and intensity can also be controlled using After Touch and MIDI controller1. If you wish to control the Pitch MG using the modulation wheel on X5, set 10A MG Wheel Select of Global mode to After Touch or JoyUp (Controller #1). (see 10A MG Wheel Select on page 162.)

12A PITCH 1 MG TRI Frq=00 Int=00	12B PITCH 1 MG Delay00 FadeIn00	12C PITCH 1 MG K.Sync=OFF	12D PMG1 FREQ K.TRK=00 A+J=0	12E PMG1 INT Aft=00 JoyUP=00
12A	12B	12C	12D	12E

LCD	Parameter	Range	Description
12A	Waveform	TRI SAW↑ SAW↓ SQR1 RAND SQR2	Triangle Sawtooth ↑ Sawtooth ↓ Square1 Random Square2
	Frequency (Frq)	0–99	Modulation Speed
	Intensity(Int)	0–99	Modulation Intensity
12B	Delay (Delay)	0–99	Time from key press to modulation start
	Fade In Time (FadeIn)	0–99	Rate at which modulation reaches specified Intensity
12C	Keyboard Sync (K.Sync)	OFF ON	Modulation will continue for subsequent notes Modulation will restart for each new note
12D	Frequency Keyboard Tracking (K.TRK)	–99...+99	Modulation sensitivity to keyboard tracking
	Frequency After Touch & Joystick (A+J)	0–9	Modulation frequency control by After Touch and Controller1
12E	After Touch Modulation Intensity (Aft)	0–99	Modulation intensity controlled by After Touch
	Joystick Modulation Intensity (JoyUp)	0–99	Modulation intensity controlled by the Controller1

12A Waveform: this parameter selects the type of modulation waveform.

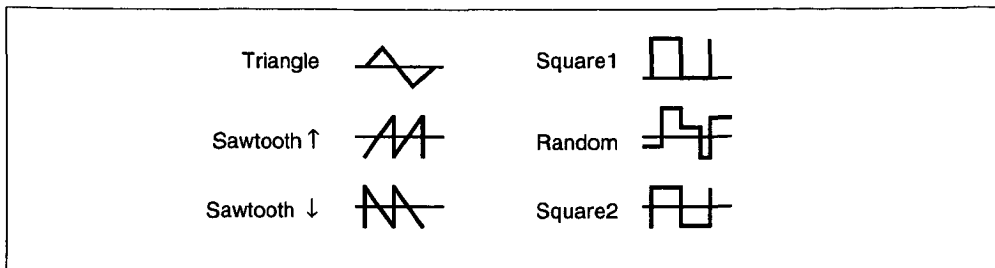

When in Square 1 is selected, the pitch changes between normal pitch and high pitch. In other waveforms, it changes between high and low.

Frequency: this parameter determines the modulation frequency (speed).

Intensity: this parameter determines the modulation intensity (depth).

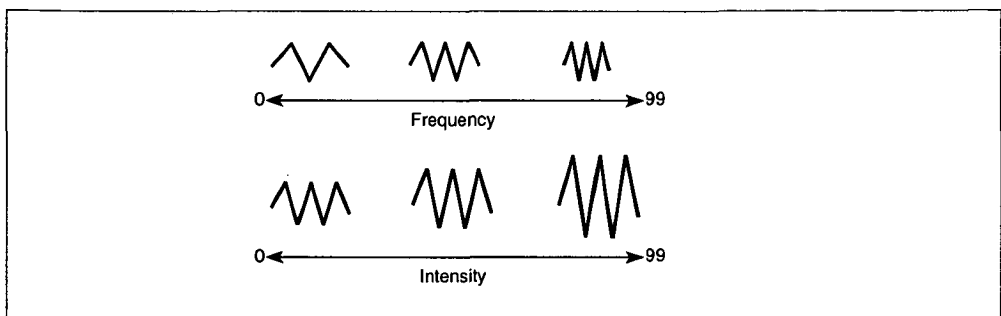

12B Delay: this parameter determines how long after a key press modulation starts.

Fade In time: this parameter specifies the time it takes modulation to reach maximum intensity.

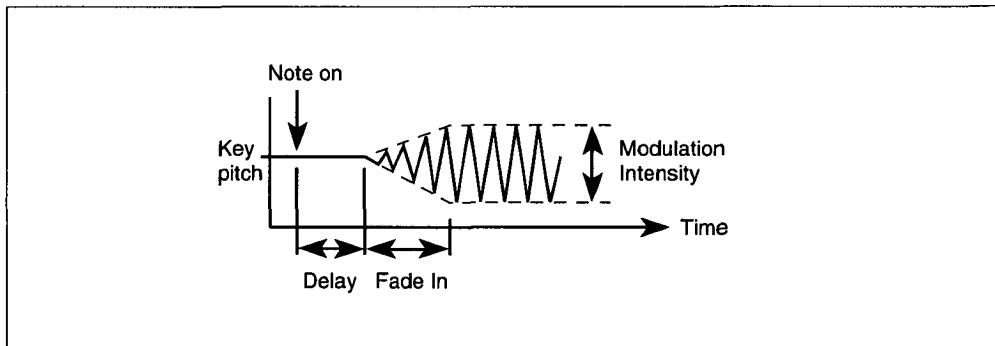

12C Keyboard Sync: determines how subsequent notes are affected by modulation. For a setting of OFF, modulation is applied to subsequent notes in the same way that it is currently being applied to notes that are already held down. That is, subsequent notes will not be affected by the Delay and Fade In Time parameters. For a setting of ON, modulation restarts for each new note.

12D Frequency Keyboard Tracking: keyboard tracking determines how modulation affects different areas of the keyboard. For positive values, the modulation frequency will increase as higher notes are played. For negative values, the modulation frequency will decrease as higher notes are played.

When Keyboard Sync is set to OFF, the modulation speed is determined by the position of the first key pressed. When keyboard tracking is set to +99, playing a key 1 octave higher will double the modulation speed. When the oscillator Octave parameter is set to 8', key C4 is the keyboard tracking center key.

Frequency After Touch & Joystick: this parameter specifies how much the modulation frequency will be increased in response to After Touch and Pitch Modulation MIDI Controller1.

12E After Touch Modulation Intensity: this parameter determines to what extent After Touch affects the modulation intensity.

Joystick Modulation Intensity: this parameter determines to what extent MIDI Controller1 affects the modulation intensity.

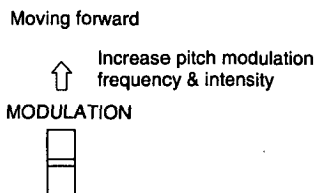

13A–13E Pitch2 Modulation

These parameters allow you to modulate the pitch of Oscillator2. Modulation frequency and intensity can also be controlled using After Touch and Pitch Modulation MIDI Controller1. Operation is the same as for Pitch1 Modulation. See “12A–12E Pitch1 Modulation” on page 86.

13A PITCH 2 MG ▸ SAW Frq00 Int00	13B PITCH 2 MG ▹ Delay00 FadeIn00	13C PITCH 2 MG ▻ K.Sync:OFF	13D PMG2 FREQ ▸ K.TRK+00 A+J=0	13E PMG2 INT ◀ Aft=00 JoyUP=00
13A	13B	13C	13D	13E

14A–14C VDF Modulation

These parameters allow you to modulate the Cutoff Frequency of VDF1, VDF2, or both.

14A VDF MG TRI Frq00 Int00	14B VDF MG Delay00 OSC= OFF	14C VDF MG K.Sync:OFF
14A	14B	14C

LCD	Parameter	Range	Description
14A	Waveform	TRI SAW↑ SAW↓ SQR1 RAND SQR2	Triangle Sawtooth ↑ Sawtooth ↓ Square1 Random Square2
	Frequency (Frq)	0–99	Modulation Speed
	Intensity (Int)	0–99	Modulation Intensity
14B	Delay	0–99	Time from key press to modulation start
	Oscillator Select (OSC)	OFF OSC1 OSC2 BOTH	Modulation off Modulation for VDF1 Modulation for VDF2 modulation for VDF1 and VDF2
14C	Keyboard Sync (K.Sync)	OFF ON	OFF: modulation will continue for subsequent notes ON: modulation will restart for each new note

These parameters are the same as those for Pitch MG, except that the Fade In Time parameter is not included here. The fade in time changes according to the Delay setting.

14A Waveform: this parameter selects the type of modulation waveform.

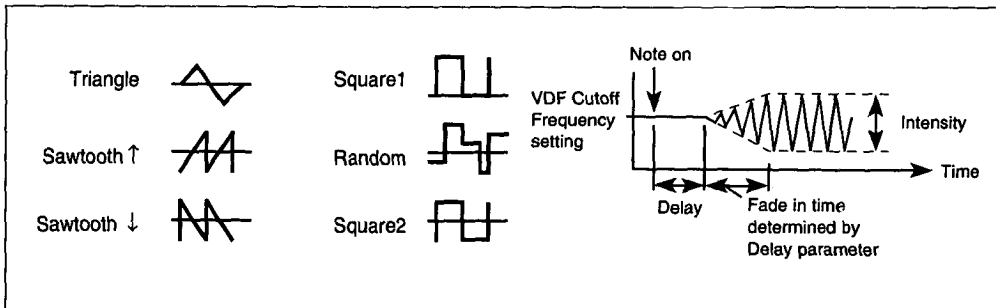

Note: When Square 1 is selected and the filter is completely open, the Cutoff Frequency does not change.

Frequency: This parameter sets the modulation speed.

Intensity: This parameter sets the modulation intensity.

14B Delay: Determines time from note-on to modulation start.

Oscillator Select: This parameter allows you to apply modulation to VDF1, VDF2, or both.

14C Keyboard Sync: Determines how subsequent notes are affected by modulation. For a setting of OFF, modulation is applied to subsequent notes in the same way it is currently being applied to notes that are already held down. That is, subsequent notes (or Note On message) will not be affected by the Delay parameter. For a setting of ON, modulation restarts for each new note.

15A–15D After Touch & Joystick Control

These parameters determine how a Program responds to After Touch, VDF Modulation MIDI Controller2 and Pitch Bender.

You can use the modulation wheel or pitch bend wheel on the X5 to control these parameters. To use the modulation wheel, set 10A MG Wheel Select in Global mode to After Touch or Joy Dw (Controller #2). (see “10A MG Wheel Select.” on page 162)

15A AFT CTRL P.Bend+12 Fc+00	15B AFT CTRL VDF.MG00 Amp+00	15C J.STK Down VDF.MG=99	15D BEND CTRL P.Bend+00 VDF+00
15A	15B	15C	15D

LCD	Parameter	Range	Description
15A	After Touch Pitch Bend (P.Bend)	-12...+12	After touch pitch bend range
	After Touch VDF Cutoff Frequency (Fc)	-99...+99	VDF Cutoff Frequency sensitivity to After Touch
15B	After Touch VDF MG Intensity (VDF.MG)	0-99	VDF modulation sensitivity to After Touch
	After Touch VDA Amplitude (Amp)	-99...+99	VDA1 sensitivity to After Touch
15C	Joystick VDF MG Intensity (VDF.MG)	0-99	VDF modulation sensitivity to the VDF Modulation MIDI Controller2
15D	Joystick Pitch Bend Range (P.Bend)	-12...+12	Pitch bend range and direction
	Joystick VDF Sweep Intensity (VDF)	-99...+99	VDF modulation sensitivity to the VDF Modulation MIDI Controller Pitch Bender

15A After Touch Pitch Bend: this parameter determines the After Touch pitch bend range (± 1 octave).

After Touch VDF Cutoff Frequency: this parameter determines how the VDF Cutoff Frequency responds to After Touch. For positive values, After Touch increases the Cutoff Frequency, thus making the sound brighter. Negative values have the opposite effect. For this parameter to have any affect, you must set the VDF Cutoff Frequency to something other than 99.

15B After Touch VDF MG Intensity: this parameter determines how VDF modulation responds to After Touch. When After Touch is applied, the VDF Cutoff Frequency is modulated. (see “14A–14C VDF Modulation” on page 89.)

After Touch VDA Amplitude: this parameter determines how the VDA responds to After Touch. In other words, how After Touch affects the volume of Oscillator1. For positive values, increasing After Touch (pressing down on a held key) increases the volume. Negative settings have the opposite effect.

15C Joystick VDF MG Intensity: this parameter determines how VDF modulation responds to the joystick (Pitch Modulation MIDI Controller2). When the modulation wheel, for which the MG Wheel Select parameter is set to “Joy Dw (Controller #2)” is moved forward as shown below, the VDF Cutoff Frequency is modulated. (see “14A–14C VDF Modulation” on page 89.)

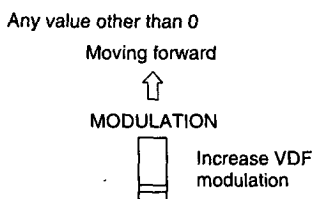

15D Joystick Pitch Bend Range: this parameter determines the pitch bend range (± 1 octave) and pitch bend direction. For positive values, the pitch increases as the pitch bend wheel is moved forward. For negative values, the pitch decreases as the pitch bend wheel is moved forward.

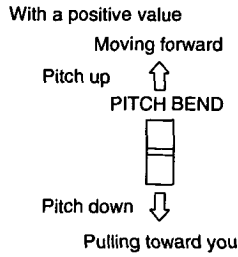

Joystick VDF Sweep Intensity: this parameter determines how the VDF Cutoff Frequency responds to pitch bend. For positive values, the Cutoff Frequency increases as the pitch bend wheel is moved forward. For negative values, the Cutoff Frequency decreases as the joystick is moved forward.

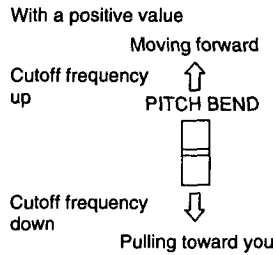

16A–21A Effects

Effects are explained fully in “Effect Parameters” on page 113.

Effects settings made in Program Edit mode only apply to Programs in Program Play mode and Program Edit mode. They do not apply when Programs are used in Combinations or in Multi setup. Effect settings for Programs used in Combinations are set in Combination Edit mode. For Programs used in Multi setup, they are set in Multi mode.

Program parameters Pan A, Pan B, Send C, and Send D are used to control the levels of the oscillator signals sent to the effects.

When you’ve edited a Program’s effect settings, always remember to write the Program. Otherwise, the settings will be lost when you select another Program.

22A–22B Program Write & Rename

When you’ve edited a Program’s effect settings, always remember to write the Program. Otherwise, the settings will be lost when you select another Program.

This function allows you to write a Program to Program bank A. This function can also be used to reorganize Program numbering by writing Programs to different destinations. You cannot write to the G bank. You can also rename Programs.

22A PROG WRITE Write→ 00 OK?	22B RENAME 00: Ephemerals
22A	22B

LCD	Parameter	Range	Description
22A	Write→xx	00–99	Select the Program write destination
	OK to Write	OK?	Executes Program write
22B	Rename	See character table below	Rename a Program

22A Program Write:

Note: To write a Program, the Program Memory Protection function must be set to OFF. See “3A – 3C Program/Combination Memory Protect & Page Memory” on page 154.

To write a Program, specify the write destination, position the cursor on OK?, then press the [▲/YES] button. The message “Are You Sure OK?” will appear. Press the [▲/YES] button to write the Program, or the [▼/NO] button to cancel. If you write the Program, the destination Program will be selected automatically. When the Write operation is completed, the screen displays “Completed.” To return to the previous screen, press the [▲/YES] button or the [▼/NO] button.

Note: The Program that already exists at the selected write destination will be lost when you execute the Program Write function.

22B Rename: This function allows you to rename Programs.

To rename a Program, use the [◀] and [▶] cursor buttons to position the cursor, and the [▲/YES] [▼/NO] buttons, or VALUE slider to select characters. Available characters are shown in the table below. Program names can be up to 10 characters.

	!	"	#	\$	%	&	'	()	*	+	,	-	.	/	0	1	2	3	4	5	6	7	8	9	:	;	<	=	>	?
0	A	B	C	D	E	F	G	H	I	J	K	L	M	N	O	P	Q	R	S	T	U	V	W	X	Y	Z	[]	^	_	
\	a	b	c	d	e	f	g	h	i	j	k	l	m	n	o	p	q	r	s	t	u	v	w	x	y	z	{		}	~	

COMBINATION Parameters

Functions in COMBINATION mode

To select a page, use the [PAGE+] or [PAGE-] button, or enter the page number directly from the numeric keypad while holding down the [EDIT] button. To select a parameter, use the [◀], [▶] cursor buttons. To set a parameter value, use the [▲/YES] and [▼/NO] buttons, or the VALUE slider, or enter the value directly from the numeric keypad while holding down the [ENTER] button. For some parameters, you can enter the number only from the number keypad to set the value. To enter a note value, play the corresponding key while pressing the [ENTER] button. If the Key Window Top, Key Window Bottom, Velocity Window Top, Velocity Window Bottom, Transpose, Detune, or MIDI filter (PROG CHANGE, DAMPER, AFTER TOUCH, CONTROL CHG) parameter has been selected, pressing the [BANK] button will allow you to select its counterpart or related parameter of the same Timbre.

Page	Function	Parameter to EDIT
0A - 0B	Program	The Program assigned to each Timbre
1A - 1B	Level	Volume of each Timbre
2A - 2B	MIDI Channel	The MIDI receive channel of each Timbre
3A - 3D	Key Window Top Key Window Bottom	Top key of keyboard range played by each Timbre Bottom key of keyboard range played by each Timbre
4A - 4D	Vel Window Top Vel Window Bottom	Maximum value of velocity for each Timbre Minimum value of velocity for each Timbre
5A - 5D	Transpose Detune	Transpose setting of each Timbre Detune setting of each Timbre
6A - 6D	Program Change Filter Damper Switch Filter After Touch Filter Control Change Filter	Program Change message receive switch for each Timbre Damper Switch message receive switch for each Timbre Aftertouch message receive switch for each Timbre Control Change message receive switch for each Timbre
7A - 7B	Panpot	Panpot between A and B of each Timbre
8A - 8B	Send	C, D output level of each Timbre
9A - 14A		Effect settings
15A - 15B	Write Combination Rename Combination	Write a Combination into memory Rename a Combination

On pages 0 to 8, if you move to a different page while a Timbre is selected, the same Timbre will be selected again.

See "Effect Parameters" on page 113.

0A, 0B Program Select

These parameters allow you to assign Programs to Timbres.

Timbres 1-4	Timbres 5-8
00A PROGRAM 1-4 A00 A01 A02 A03	00B PROGRAM 5-8 A04 G01 G99 128
0A	0B

LCD	Parameter	Range	Description
0A	Timbre 1 Program Select	OFF A00-A99 G01-136	Assign a Program to a Timbre
	Timbre 2 Program Select		
	Timbre 3 Program Select		
	Timbre 4 Program Select		
0B	Timbre 5 Program Select		
	Timbre 6 Program Select		
	Timbre 7 Program Select		
	Timbre 8 Program Select		

Here you can select a Program for each Timbre.

The Timbre that is set to "OFF" will not sound.

A Program must be selected from Bank A and G.

Incoming Program Change messages will select Programs for Timbres of the corresponding channel.

However, if the MIDI channel of the received Program Change is the same as the Global MIDI channel of the X5, the Combination will change.

To avoid changing the Combination via MIDI, set the 2D MIDI FILTER PRG in the Global Mode to "PRG". To change only the number, without changing the bank, set the Program to "NUM".

To see how the various timbres correspond to the MIDI Bank Select and Program Change functions, please refer to "Selecting Programs" on page 24. The user should be aware that these are not received for timbres which have been turned off.

Programs available

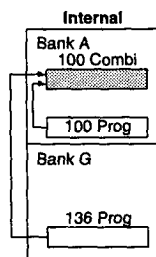

1A, 1B Level

These parameters allow you to set the volume level of each Timbre in a Combination.

Timbres 1-4		Timbres 5-8	
01A LEVEL 1-4	127 099 011 127	01B LEVEL 5-8	055 127 127 127
1A		1B	

LCD	Parameter	Range	Description
1A	Timbre 1 Level	0-127	Sets the volume level of each Timbre
	Timbre 2 Level		
	Timbre 3 Level		
	Timbre 4 Level		
1B	Timbre 5 Level		
	Timbre 6 Level		
	Timbre 7 Level		
	Timbre 8 Level		

With a value of 127, the volume uses the level setting of the Timbre program parameter. With a value of 0, no sound is output.

The volume level is determined by this parameter multiplied by the value set for MIDI Volume Controller No. 7, or Expression Controller No. 11.

2A, 2B MIDI Channel

These parameters allow you to set the MIDI Channel that each Timbre uses to receive MIDI data.

Timbres 1-4				Timbres 5-8			
02A MIDI CH 1-4				02B MIDI CH 5-8			
1G	2	3	4	5	6	7	8
2A				2B			

LCD	Parameter	Range	Description
2A	Timbre 1 MIDI Channel	1-16	Sets the MIDI Channel that each Timbre uses to receive MIDI data
	Timbre 2 MIDI Channel		
	Timbre 3 MIDI Channel		
	Timbre 4 MIDI Channel		
2B	Timbre 5 MIDI Channel		
	Timbre 6 MIDI Channel		
	Timbre 7 MIDI Channel		
	Timbre 8 MIDI Channel		

If you want to play a Combination from the keyboard, you should set each Timbre's MIDI Channel so that it matches the Global MIDI Channel. If you are using an external MIDI sequencer, set each Timbre's MIDI Channel so that it matches the corresponding sequencer track's MIDI channel. This allows you to use the X5 as an 8-part multitimbral tone generator.

If the selected MIDI Channel is the same as the Global MIDI Channel, a G will appear next to the selected channel number.

MIDI Program Change messages received on the corresponding MIDI channel can be used to select Programs. However, if the Timbre's MIDI Channel is the same as the Global MIDI Channel, a program change sent on it's channel will change the Combination.

If you do not wish to change the Combination, set the Global MIDI Channel to any channel that is not used for the Timbre, or set the 2D MIDI FILTER PRG parameter in Global mode to "PRG". (see page 153.)

3A-3D Key Window Top & Bottom

These parameters allow you to set the top and bottom notes for each Timbre's key window.

Timbres 1-4		Timbres 5-8		Timbres 1-4		Timbres 5-8	
03A KW TOP 1-4	03B KW TOP 5-8	03C KW BTM 1-4	03D KW BTM 5-8				
G9 G9 G9 G9	B4 G9 G9 G9	C-1 C-1 C-1 C-1	C-1 C-1 C-1 C-1				
3A	3B	3C	3D				

LCD	Parameter	Range	Description
3A	Timbre 1 Key Window Top	C-1 to G9	Specifies the top note for each Timbre's key window
	Timbre 2 Key Window Top		
	Timbre 3 Key Window Top		
	Timbre 4 Key Window Top		
3B	Timbre 5 Key Window Top		
	Timbre 6 Key Window Top		
	Timbre 7 Key Window Top		
	Timbre 8 Key Window Top		
3C	Timbre 1 Key Window Bottom	C-1 to G9	Specifies the bottom note for each Timbre's key window.
	Timbre 2 Key Window Bottom		
	Timbre 3 Key Window Bottom		
	Timbre 4 Key Window Bottom		
3D	Timbre 5 Key Window Bottom		
	Timbre 6 Key Window Bottom		
	Timbre 7 Key Window Bottom		
	Timbre 8 Key Window Bottom		

A key window is the range of keys (notes) that can be used to play a Timbre. Used in conjunction with the Key Window Bottom parameters, you can designate sections of a keyboard to certain Timbres. For example, you could designate the bottom half of a keyboard to a bass Timbre, and the top half to a piano Timbre. In the example shown below, Timbres 1 and 2 have been designated their own key windows, while the key window for Timbres 3 and 4 have been set the same.

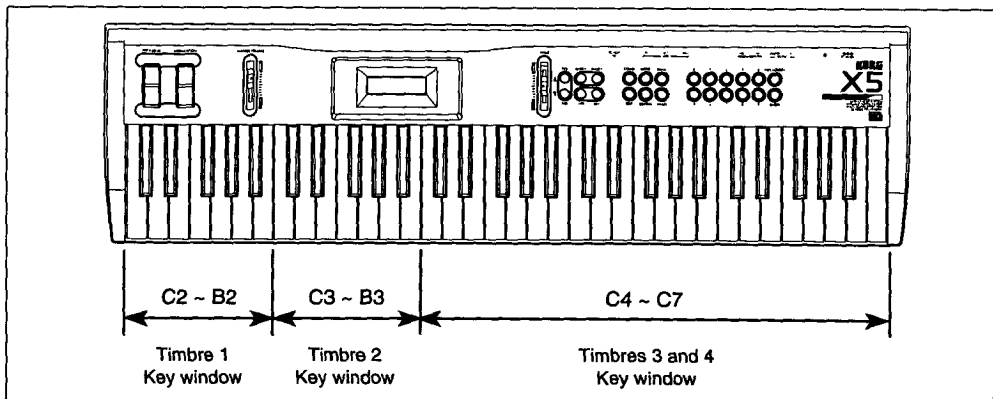

You can enter a note name from the keyboard. Press the desired key while holding down the [ENTER] button. (Refer to "Keyboard Input" on page 67.)

You can not set the top key to lower than the bottom key. Otherwise, the bottom key will be set to the same value as the top key. The same thing applies to the bottom Key.

4A–4D Velocity Window Top & Bottom

These parameters allow you to set the maximum and minimum velocities for each Timbre's velocity window.

Timbres 1–4		Timbres 5–8		Timbres 1–4		Timbres 5–8	
04A UW TOP 1–4	04B UW TOP 5–8	04C UW BTM 1–4	04D UW BTM 5–8	001 001 001 001	001 001 001 001	001 001 001 001	001 001 001 001
127 127 127 127	127 127 127 127						
4A		4B		4C		4D	

LCD	Parameter	Range	Description
4A	Timbre 1 Velocity Window Top	1–127	Specifies the maximum velocity for each Timbre's Velocity window
	Timbre 2 Velocity Window Top		
	Timbre 3 Velocity Window Top		
	Timbre 4 Velocity Window Top		
4B	Timbre 5 Velocity Window Top		
	Timbre 6 Velocity Window Top		
	Timbre 7 Velocity Window Top		
	Timbre 8 Velocity Window Top		
4C	Timbre 1 Velocity Window Bottom	1–127	Specifies the minimum velocity for each Timbre's Velocity window
	Timbre 2 Velocity Window Bottom		
	Timbre 3 Velocity Window Bottom		
	Timbre 4 Velocity Window Bottom		
4D	Timbre 5 Velocity Window Bottom		
	Timbre 6 Velocity Window Bottom		
	Timbre 7 Velocity Window Bottom		
	Timbre 8 Velocity Window Bottom		

A velocity window determines the note velocity range that can be used to play a Timbre.

5A–5D Transpose & Detune

These parameters allow you to transpose and detune Timbres.

Timbres 1–4		Timbres 5–8		Timbres 1–4		Timbres 5–8	
05A TRANS	1-4	05B TRANS	5-8	05C DETUNE	1-4	05D DETUNE	5-8
+00	+07 +00 +00	+00	+00 +00 +00	+00	+03 +00 +00	+00	+00 +00 +00
	5A		5B		5C		5D

LCD	Parameter	Range	Description
5A	Timbre 1 Transpose	-24...+24	Transpose Timbre in semitone steps
	Timbre 2 Transpose		
	Timbre 3 Transpose		
	Timbre 4 Transpose		
5B	Timbre 5 Transpose		
	Timbre 6 Transpose		
	Timbre 7 Transpose		
	Timbre 8 Transpose		
5C	Timbre 1 Detune	-50...+50	Detune each Timbre in one cent steps
	Timbre 2 Detune		
	Timbre 3 Detune		
	Timbre 4 Detune		
5D	Timbre 5 Detune		
	Timbre 6 Detune		
	Timbre 7 Detune		
	Timbre 8 Detune		

5A, 5B Transpose: it adjusts each Timbre's pitch in the range of $-24\dots+24$ in semitone steps. (12 = octave).

5C, 5D Detune: it sets each Timbre's pitch in cent steps in the range of $-50\dots+50$ (100 cents = semitone).

6A–6D MIDI Filter

These parameters allow you to control how the X5 will handle MIDI data.

Timbres 1–8	Timbres 1–8	Timbres 1–8	Timbres 1–8
06A PROG CHANGE	06B DAMPER	06C AFTER TOUCH	06D CONTROL CHG
E E D D E E E E	E E E E E E E E	E E E E E E E E	E E E E E E E E
6A	6B	6C	6D

LCD	Parameter	Range	Description
6A	Timbre 1 Program Change Filter	D: Disable E: Enable	Program Change messages ignored Program Change messages can be received and sent
	Timbre 2 Program Change Filter		
	Timbre 3 Program Change Filter		
	Timbre 4 Program Change Filter		
	Timbre 5 Program Change Filter		
	Timbre 6 Program Change Filter		
	Timbre 7 Program Change Filter		
	Timbre 8 Program Change Filter		
6B	Timbre 1 Damper Pedal Filter	D: Disable E: Enable	Timbre will ignore the damper pedal Timbre will respond to the damper pedal
	Timbre 2 Damper Pedal Filter		
	Timbre 3 Damper Pedal Filter		
	Timbre 4 Damper Pedal Filter		
	Timbre 5 Damper Pedal Filter		
	Timbre 6 Damper Pedal Filter		
	Timbre 7 Damper Pedal Filter		
	Timbre 8 Damper Pedal Filter		
6C	Timbre 1 After Touch Filter	D: Disable E: Enable	Timbre will ignore After Touch Timbre will respond to After Touch
	Timbre 2 After Touch Filter		
	Timbre 3 After Touch Filter		
	Timbre 4 After Touch Filter		
	Timbre 5 After Touch Filter		
	Timbre 6 After Touch Filter		
	Timbre 7 After Touch Filter		
	Timbre 8 After Touch Filter		
6D	Timbre 1 Control Change Filter	D: Disable E: Enable	Timbre will ignore controllers Timbre will respond to controllers
	Timbre 2 Control Change Filter		
	Timbre 3 Control Change Filter		
	Timbre 4 Control Change Filter		
	Timbre 5 Control Change Filter		
	Timbre 6 Control Change Filter		
	Timbre 7 Control Change Filter		
	Timbre 8 Control Change Filter		

6A Program Change Filter: These parameters determine how EXT mode Timbres work with MIDI Program Change messages.

Enable: with this setting, received Program Change messages select Programs for a Timbre.

Use 2D MIDI FILTER PRG in Global mode to set the global X5 Program Change filter. (see 2D Program Change Filter on page 153.)

If this is set to D (Disable), the Program Change messages will be ignored.

Note: *If the Global mode MIDI Program Change Filter1 is set to DIS ("PRG of 2D MIDI FILTER" on page 153), Program Change messages are completely disabled. This setting overrides the above settings. Furthermore, if the Global mode MIDI Program Change Filter1 is set to ENA, Program Change messages received on the channel that matches the Global MIDI Channel will select Combinations. If it is set to PRG, the messages will not select Combinations. Instead, they will select Programs for the timbre on the channel that matches the Global MIDI Channel according to the setting here. (See page 153, 2D Program Change Filter.)*

6B Damper Pedal Filter: These parameters determine how Timbres respond to damper pedal movements.

Enable: with this setting, INT mode Timbres respond to damper pedal movements.

Disable: with this setting, damper pedal effect is not applied.

6C After Touch Filter: These parameters determine how Timbres respond to After Touch.

Enable: with this setting, INT mode Timbres respond to After Touch. Ext mode Timbres using keyboard After Touch output the corresponding MIDI data.

Disable: with this setting, After Touch effect is not applied.

You can use After Touch for the modulation wheel functions. See 10A MG Wheel Select on page 162.

6D Control Change Filter: These parameters determine whether Timbres respond to MIDI Controllers.

Enable: with this setting, INT mode Timbres respond to controllers.

Disable: with this setting, controllers are ignored.

7A, 7B Panpot

These parameters allow you to pan the output of each Timbre between buses A and B. These buses feed the effects processors. See “20A–20B Effect Placement” on page 115.

Timbres 1–4				Timbres 5–8			
07A	PANPOT	1–4	▶	07B	PANPOT	5–8	◀
A	B	CNT	CNT	10A	10B	CNT	PRG
7A				7B			

LCD	Parameter	Range	Description
7A	Timbre 1 Panpot	OFF, A15–CNT–B15, PRG	Pans the outputs of each Timbre between buses A and B
	Timbre 2 Panpot		
	Timbre 3 Panpot		
	Timbre 4 Panpot		
7B	Timbre 5 Panpot		
	Timbre 6 Panpot		
	Timbre 7 Panpot		
	Timbre 8 Panpot		

OFF: nothing is output to buses A and B.

A15–CNT–B15: You can set different output levels for buses A and B with settings A15 to B15. For a setting of A15, Timbre output is to bus A only. For a setting of B15, to bus B only. And for a setting of CNT, equally to buses A and B.

PRG: when this setting is selected, the pan settings that have been set for a Program in Program Edit mode are used. See “1A–1D Oscillator1 Setup” on page 71 and “2A–2F Oscillator2 Setup” on page 73.

If a Program is using a drum kit, the pan settings for each drum sound will be used when PRG is selected. See “6A–6D Drum Kit1 Setup” on page 158 and “7A–7D Drum Kit2 Setup” on page 160.

For a setting other than OFF or PRG, these parameters can be controlled using MIDI Pan Controller No. 10. See “MIDI Panpot, Send Data” on page 165 for details about the relationship between pan value and MIDI Controller value.

8A, 8B Send C & Send D

These parameters allow you to set the output level of each Timbre sent to buses C and D. These buses feed the effects processors. See “20A–20B Effect Placement” on page 115.

Timbres 1–4		Timbres 5–8	
08A SENDCD 1-4	08B SENDCD 5-8		
9:0 0:9 5:5 5:5	5:5 5:5 0:0 P:P		
8A		8B	

LCD	Parameter	Range	Description
8A	Timbre 1 Send C	0–9, P	Sets the output level of each Timbre sent to buses C and D
	Timbre 1 Send D		
	Timbre 2 Send C		
	Timbre 2 Send D		
8B	Timbre 3 Send C		
	Timbre 3 Send D		
	Timbre 4 Send C		
	Timbre 4 Send D		
	Timbre 5 Send C		
	Timbre 5 Send D		
	Timbre 6 Send C		
	Timbre 6 Send D		
8B	Timbre 7 Send C		
	Timbre 7 Send D		
	Timbre 8 Send C		
	Timbre 8 Send D		

0–9: when a Program is used in a Combination, its Send C and Send D parameters are ignored, and these settings are active. Oscillators 1 and 2 use the same settings. Likewise, when the Program is set to DRUM mode, the Send C and Send D settings of the individual drums within the kit are ignored, and these settings are active.

P: when this setting is selected, the Send C and Send D settings that have been set for a Program in Program Edit mode are used. See “1A–1D Oscillator1 Setup” on page 71 and “2A–2F Oscillator2 Setup” on page 73. If a Program is using a drum kit, the settings for each drum sound will be used. See “6A–6D Drum Kit1 Setup” on page 158 and “7A–7D Drum Kit2 Setup” on page 160.

For settings from 0–9, the Send C parameters can be controlled using MIDI Reverb Level Controller No. 91. MIDI Chorus Level Controller No. 93 can be used to control Send D.

See “MIDI Panpot, Send Data” on page 165 for details about the relationship between send value and MIDI Controller value.

9A–14A Effects

In a Combination the individual effect settings of each Program are ignored, and the settings for that Combination are used. If you want to use a Program's effect settings for a Combination, use Effects Copy 14A COPY EFF. See "21A Copy Effects" on page 117.

Effects are explained in "Effect Parameters" on page 113.

Combination parameters Pan A, Pan B, Send C, and Send D are used to control the levels of the Timbres sent to the effects.

When you've edited a Combination's effects settings, always remember to write the Combination. Otherwise, the settings will be lost when you select another Combination.

15A, 15B Combination Write & Rename

This function allows you to write a Combination to the internal memory. This function can also be used to reorganize Combination numbering by writing Combinations to different destinations. (The Combination that exists at destination will be lost when another Combination overwrites it.)

The Rename function allows you to name the Combination.

15A COMB WRITE	15B RENAME
Write→ 00 OK?	00:Organ
15A	15B

LCD	Parameter	Range	Description
15A	Write→xxx	00–99	Select the Combination write destination
	OK to Write	OK?	Executes write
15B	Rename	See character table below	Rename a Combination

15A Combination Write:

Note: To write a Combination, the Combination Memory Protection function must be set to OFF. See "3B Combination Memory Protect" on page 154.

To write a Combination, specify the write destination, position the cursor on OK?, then press the [▲/YES] button. The message "Are You Sure OK?" will appear. Press the [▲/YES] button to write the Combination, or the [▼/NO] button to cancel. If you write the Combination, the destination Combination will be selected automatically. When the write operation is completed, the display shows "Completed." Press the [▲/YES] button or the [▼/NO] button to return to the previous screen.

Note: The Combination that already exists at the selected write destination will be lost when you execute this function.

15B Rename: This function allows you to rename Combination.

Move the cursor to the desired character using the [◀] and [▶] buttons, and use the VALUE slider or the [▲/YES] and [▼/NO] buttons to enter the character. Use the number keypad to insert numbers. You can use the characters listed below. Up to 10 characters can be used for a Combination name.

!	"	#	\$	%	&	'	()	*	+	,	-	.	/	0	1	2	3	4	5	6	7	8	9	:	;	<	=	>	?
@	A	B	C	D	E	F	G	H	I	J	K	L	M	N	O	P	Q	R	S	T	U	V	W	X	Y	Z	[]	^	_
\	a	b	c	d	e	f	g	h	i	j	k	l	m	n	o	p	q	r	s	t	u	v	w	x	y	z	{	}	~	+

Multi Setup Parameters

Multi Setup Functions

To select a page, use the [PAGE+] or [PAGE-] button, or enter the page number directly from the numeric keypad while holding down the [EDIT] button. To select a parameter, use the [◀], [▶] cursor buttons. To set a parameter value, use the [▲/YES] and [▼/NO] buttons, or the VALUE slider, or enter the value directly from the numeric keypad while holding down the [ENTER] button. For some parameters, you can enter the number only from the numeric keypad to set the value. To enter a note value, play the corresponding key while pressing the [ENTER] button.

Refer to “Effect Parameters” on page 113 for detailed information on effects.

Page		Function	Parameter to edit
0A–0G (Track 1 setting)	*A	Program	Program of each Track
	*B	Level	Volume of each Track
		Panpot	Pan setting (A/B output balance) of each Track
		Send C	Track level at output C
		Send D	Track level at output D
	*C	Transpose	Transpose setting of each Track
		Detune	Detune setting of each Track
Pitch Bend Range		Pitch bend range of each Track	
*D	Program Change Filter	Program Change messages reception switch for each Track	
	Damper Switch Filter	Damper switch for each Track	
	After Touch Filter	After Touch switch for each Track	
	Control Change Filter	Control Change switch for each Track	
*E	Key Window Top	Top key of the Track note range	
	Key Window Bottom	Bottom key of the Track note range	
15A–15G (Track 16 setting)	*F	Vel Window Top Vel Window Bottom	Maximum velocity of each Track Minimum velocity of each Track
	*G	MIDI Channel	MIDI receive channel of each Track
16A–21A		Effect	Effect setting
22A		Copy from Combination	Copy from Combinations
23A		Set to GM	Initialize for GM

* 0–15 correspond to Tracks 1–16.

In Multi mode, pages 0–15 correspond to Tracks 1–16; pages 16–21 handle effect settings; page 22 enables you to copy parameters from Combinations; page 23 is used to initialize the X5 for GM setting.

When you select a different Track while editing a particular parameter (for one of the 16 Tracks in pages 0–15), the same parameter of the new Track is automatically selected.

- Multi mode settings are lost when you turn off the power to the X5. When you turn on the power to the X5, all settings in Multi mode are reset to GM-compatible data. (see page 112.)
- Save Multi mode settings to an external storage device such as a MIDI data filter using 4A MIDI DUMP in Global mode (see page 155). In Multi mode, only effect data is compatible between the X5 and the X5DR.

*A Program

This page allows you to select a Program for each Track.

```
00A MULTI T01 ▶
G01:Piano
```

*A

LCD	Parameter	Range	Description
*A	Program	*** /A00-A99 /G01-136	Selecting a Program.

Tracks set to “***” do not produce sound.

You may select Programs from only Bank A or Bank G.

The Programs are changed when the MIDI channel of the Bank Select or Program Change messages received on the Tracks matches the MIDI Channel assigned to the Tracks in Multi mode. However, this may not apply depending on the settings of *D MIDI FILTER (page 109) and 2D MIDI FILTER PRG in Global mode (see page 153).

When the power is turned on, when 23A SET TO GM is executed, or when a GM ON message is received via MIDI, GM-compatible drum Program G129 will be automatically selected for Track 10, and Program G01 will be selected for all other Tracks.

You may also select a Bank using the MIDI Bank Select messages as shown in the table. These messages will change the Bank only when subsequent Program Change messages are received. You do not send MIDI Bank Select messages to switch Programs within a Bank. Therefore, send the MIDI Bank Select messages only when you wish to change the Bank, or set 2D MIDI FILTER PRG of Global mode to “NUM” (to ignore MIDI Bank Select) after you switch the Bank by sending the MIDI Bank Select messages. To receive MIDI Bank Select messages, set this value to “ENA” or “PRG.”

MIDI Bank Select (MSB) (LSB)		X5 Bank
00	00	Bank A
38	**	Bank G (01-128)
3E	**	Bank G (129-136)
3F	**	(Timbre OFF)

** : any number

Refer to the table for how to select a Program in Bank G (129-136).

In the GM standard, MIDI Channel 10 is used for a drum (or percussion) sound, the Instruments (percussion names) are already specified for each note number (refer to “Drum Kit Map.”). ROM Drum Kit 1 on the X5 is the GM-compatible Drum Kit which serves as a sound source for Bank G Program 129. Use this Program for GM songs. The X5 also provides other drum Programs 130-136 in Bank G that use ROM Drum Kits 2-8, respectively, for commercially-available non-GM song data.

As shown in the table below, incoming MIDI Program Change messages will select a corresponding drum Program, if the Bank Select messages [Bn, 00, 3E, 20, 00] (n: MIDI Channel) have already been sent. (The Bank for drum sounds has already been selected for Track 10 in Multi mode when the power was turned on to the X5.)

MIDI Prog Change No.	X5 Program No.
00-15, 56-63, 72-127	(0) G129
16-23	(16) G130
25	(25) G131
32-39	(32) G132
40-47	(40) G133
64-71	(64) G134
24, 26-31	(24) G135
48-55	(48) G136

For Channels other than Channel 10, you can select any of 128 Programs (see the GM Program List) that are already assigned by GM to corresponding Program Change numbers. On the X5, Programs 01–128 in Bank G are available for GM songs. You can also send MIDI Bank Select messages [Bn, 00, (MSB), 20, (LSB)] to select a Program in Bank A, or to select a drum Program as on Channel 10.

In the same manner, you can select a non-drum Program for Channel 10 by sending the MIDI Bank Select messages on that channel. (see page 111.)

*B Level, Pan, Send

This page lets you adjust the volume level and output settings for each Track.

```
00B Lev Pan Sen#
T01 100 CNT 2:2
```

*B

LCD	Parameter	Range	Description
*B	Level (Lev) Panpot (Pan) Send C (Sen) Send D (Sen)	0–127 OFF, A15–CNT–B15, PRG 0–9, P 0–9, P	Volume level Panpot (between A and B) setting Level C setting Level D setting

Level: Adjusts the volume level output setting for each Track.

The resultant volume level for each track is obtained by multiplying the MIDI Volume data [Bn, 07, xx] (Controller #7), MIDI Expression data [Bn, 0B, xx] (Controller #11), and the value displayed on the screen. The level parameter value indication is not affected by MIDI Control Change messages.

MIDI Volume data is set to 100 when Multi mode is entered, when 23A SET TO GM is executed, or when a GM ON message is received.

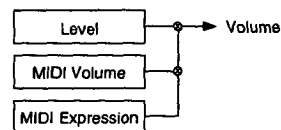

Panpot: Adjusts the A and B output balance of each Track.

Setting OFF outputs no signal at A or B. Setting A15 outputs signal only from A; setting B15 outputs signal only from B; and setting CNT (Center) outputs the same signal level from A and B.

With the PRG setting, the panpot setting of the Program selected for the Track is used. (You can specify the panpot setting for each oscillator in Program Edit mode.) With settings other than “PRG” (A15–B15), both Oscillator 1 and 2 of the Program use the same panpot setting.

If you have already selected a Program using a Drum Kit (OSC mode set to DRUMS) and you select “PRG” here, the panpot setting for each Instrument of the Drum kit will be used. If you set this parameter to A15 – B15, the panpot setting of each Instrument is ignored, and the parameter setting here becomes effective.

You can control the panpot setting of each Track by sending MIDI Pan Change data [Bn, 0A, xx] (Controller #10). (With a setting of OFF or PRG, the MIDI Pan Change data is ignored.) When you specify [00] for [xx], the parameter value is set to A15, and when you specify 127 [7F] for [xx], the parameter value is set to B15. You need to specify 64 [40] for the CNT setting.

Refer to “MIDI Panpot, Send Data” on page 165 for MIDI data corresponding to the panpot settings.

- When the power is turned on, when 23A SET TO GM is executed, or when a GM ON message is received, Track 10 will use the PRG setting, and other Tracks will use the CNT setting.

Send: Sets the C and D output level of each Track.

Setting “P (Program)” selects the Send setting of the Program selected for the Track. (You can set Send for each oscillator in Program Edit mode.) Specifying a value other than “P” sets the output of Oscillator 1 and 2 to the same level.

When a Track uses a Program that uses a Drum Kit (OSC mode set to DRUMS), and you set this parameter to “P”, the Send setting of each Index in the Drum kit takes effect. In this case, the value of Send C and D of the Program will be applied to the Send setting value of each Instrument. With a value of 0 – 9, the setting of each Index is ignored, and the value specified here becomes effective.

You can also change the setting using the MIDI messages.

Send C [Bn, 5B, xx] (Controller #91)

Send D [Bn, 5D, xx] (Controller #93)

Generally, [Bn, 5B, xx] is used to control the Reverb Depth and [Bn, 5D, xx] is used to control the Chorus Depth. Refer to “MIDI Panpot, Send Data” on page 165 for the MIDI data corresponding to the send settings.

- When the power is turned on, when 23A SET TO GM is executed, or when a GM ON message is received, Track 10 will use the P:0 setting, and other Tracks will use the 2:2 setting.

*C Transpose, Detune, Bend Range

This page allows you to adjust the pitch-related settings.

00C Tra Det Bnd
T01 +00 +00 +02

*C

LCD	Parameter	Range	Description
*C	Transpose (Tra)	-24...+24	Adjust the pitch in chromatic steps (within ±2 octaves).
	Detune (Det)	-50...+50	Adjusts the pitch in steps of 1 cent (within ±50 cents).
	Bend Range (Bnd)	-12...+12	Determines how the pitch is modified by the pitch bend wheel.

Transpose: Transpose adjusts the pitch of each Track in chromatic steps over a range of -24 to +24. (Twelve chromatic steps equal one octave).

You can also change the setting by sending MIDI Coarse Tune messages. Refer to “Controller Event Edit Notes” on page 163 for details.

- When the power is turned on to the X5 or when a GM ON message is received, this parameter is automatically reset to 00.

Detune: Detune is a fine pitch adjustment for each Track that moves in steps of one cent, over a range of -50 to +50 (100 steps equal one chromatic step).

You can also change the setting by sending MIDI Fine Tune messages. Refer to “Controller Event Edit Notes” on page 163 for details.

- When the power is turned on to the X5, when 23A SET TO GM is executed, or when a GM ON message is received, this parameter is automatically reset to 00.

Bend Range: The Bend Range for the Pitch Bend messages adjusts the pitch direction and variation of each Track produced by the pitch bend wheel in chromatic steps.

The pitch bend range specified in a Track’s Program (set on 15D in Program Edit mode) is ignored, and this setting takes effect. (The setting here does not affect the Program setting.)

A maximum of 12 chromatic steps forms a single octave. With a positive value, the farther the pitch bend wheel is moved forward, the higher the pitch. A negative value produces the opposite effect.

You can change the setting by sending MIDI Pitch Bend Range data, but the value is limited to a range of 0 – +12. Refer to “Controller Event Edit Notes” on page 163.

- When the power is turned on to the X5, when 23A SET TO GM is executed, or when a GM ON message is received, this parameter is automatically reset to 00 for Track 10, and to +2 for other Tracks.

*D MIDI Filter

This page determines whether or not each Track will receive the MIDI Program Change and whether or not Damper effect, After Touch effect, and Control effect are applied.

00D Pf Df Af Cf
T01 EN EN DI EN

*D

LCD	Parameter	Range	Description
*D	Program Change Filter (Pf)	DI: Disable EN: Enable	Program Change message is ignored. Program Change message is received.
	Damper Pedal Filter (Df)	DI: Disable EN: Enable	Damper Pedal message is ignored. Damper Pedal is effective.
	After Touch Filter (Af)	DI: Disable EN: Enable	After Touch message is ignored. After Touch is effective.
	Control Change Filter (Cf)	DI: Disable EN: Enable	MIDI Controllers are ignored. MIDI Controllers are effective.

Program Change Filter: Determines whether or not each Track receives the MIDI Program Change messages.

EN: Tracks with the EN (Enable) setting receive the Program Change messages and switch the Programs. Set the overall X5 Program Change Filter on 2D MIDI FILTER PRG in Global mode. (see "2D Program Change Filter" on page 153.)

Note: If the Global mode 2D MIDI FILTER PRG is set to "DIS", the Program Change messages are completely disabled. Furthermore, if you set it to ENA or PRG, Bank Select and Program Change messages will select Bank and Program. If you set it to "NUM", only the Program is changed. (see "2D Program Change Filter on page 153)

Damper Pedal Filter: Determines whether or not the Damper Pedal messages will affect the Track sound.

EN: The Damper Pedal messages affect the sound of the Track for which "EN (Enable)" is selected.

DI: The Damper Pedal effects are not applied to the Tracks for which "DI (Disable)" is selected.

After Touch Filter: Determines whether or not the After Touch messages will affect the Track sound.

EN: After Touch messages affect the sound of the Track for which "EN (Enable)" is selected.

DI: After Touch effects are not applied to the Tracks for which "DI (Disable)" is selected.

Control Change Filter: Determines whether or not the controllers (e.g., pitch bend, pitch modulation, etc.) or the Volume Change messages affect the sound of each Track.

EN: The Controller messages affect the sound of the Track for which "EN (Enable)" is selected.

DI: The Controller messages are ignored on the Tracks for which "DI (Disable)" is selected.

- When the power is turned on to the X5/X5D, when 23A SET TO GM is executed, or when a GM ON message is received, these parameters are set to EN for all the tracks.

*E Key Window Top & Bottom

These parameters allow you to set the top note and bottom note for each Track.

```
00E KWTOP KWBtm
T01 G9 C-1
```

*E

LCD	Parameter	Range	Description
*E	Key Window Top (KWTop)	C-1~G9	Specifies the top note for each Track's key window.
	Key Window Bottom (KWBtm)	C-1~G9	Specifies the bottom note for each Track's key window.

A key window is the range of keys (notes) that you can use to play a Track. Used in conjunction with the Key Window Bottom parameters, you can assign sections of the keyboard to specific Tracks. For example, you could designate the bottom half of the keyboard to a bass Track, and the top half to a piano Track.

You can use the VALUE slider and the [▲/YES] and [▼/NO] buttons to set the Key Window Top and Bottom parameters. You can also use the X5 keyboard for the same purpose, as follows: select a Key Window parameter; press and hold down the [ENTER] button; then press the desired key. The setting range is from C2 to C7 (if the Global mode Transpose parameter is set to +00).

You can not set the top key to lower than the bottom key. Otherwise, the bottom key will be set to the same value as the top key. The same thing applies to the bottom Key.

- When the power is turned on to the X5, when 23A SET TO GM is being executed, or when a GM System ON message is received, the top key of each track is set to G9, and the bottom key of each track is set to C-1.

*F Velocity Window Top & Bottom

These parameters allow you to set the maximum and minimum velocity for each Track's velocity window.

```
00F VWTOP VWBtm
T01 127 001
```

*F

LCD	Parameter	Range	Description
*F	Velocity Window Top (VWTop)	1~127	Specifies the maximum velocity for each Track.
	Velocity Window Bottom (VWBtm)	1~127	Specifies the minimum velocity for each Track.

A velocity window determines the note velocity range that can be used to play a Track. Used in conjunction with the Velocity Window Bottom parameters, you can specify a note velocity range for each Track. For example, you could set a soft strings Track to a low velocity window, and a hard strings Timbre to a high velocity window. Then, playing softly will trigger the soft strings, and playing strongly will trigger the hard strings. This technique is called a velocity switch. You can also set the velocity windows so that their ranges overlap.

- When the power is turned on to the X5, when 23A SET TO GM is being executed, or when a GM System ON message is received, the maximum velocity of each track is set to 127, and the minimum velocity is set to 1.

*G MIDI Channel

These parameters allow you to set the MIDI Channel that each Track uses to receive MIDI data.

```
00G MIDI Ch
T01 1G
```

*G

LCD	Parameter	Range	Description
*G	MIDI Channel	1~16	Sets the MIDI Channel that each Track uses to receive MIDI data.

If you want to play a Track from the keyboard, you should set each Track's MIDI Channel so that it matches the Global MIDI Channel. If you are using a sequencer, set each Track's MIDI Channel so that it matches the corresponding sequencer track's MIDI Channel.

If the selected MIDI Channel is the same as the Global MIDI Channel, a G will appear next to the selected channel number.

- When the power is turned on to the X5, when 23A SET TO GM is being executed, or when a GM System ON message is received, the MIDI Channel of Traks 1–16 is set to 1–16.

16A – 21A Effect

Effects are explained in "Effect Parameters" on page 113.

The individual effect settings of each Program are ignored, and these settings are used.

If you want to use a Program's or a Combination's effect settings, use the 21A COPY EFF function to copy effects.

Track parameters Pan A, Pan B, Send C, and Send D are used to control the level of the Tracks sent to the effects in Multi mode.

Effects can be controlled via MIDI on the Global MIDI Channel. You can control the level of each Track to the effects using the Track parameters Pan A, Pan B, Send C, and Send D.

- When the power is turned on to the X5, when 23A SET TO GM is being executed, or when a GM System ON message is received, Effect 1 selects Hall, Effect 2 selects Chorus 1, Placement selects Parallel3, and the effect return level is set to 4.

22A Copy from Combination

This function allows you to copy Combination Timbre settings to Tracks 1 to 8 or Tracks 9 to 16.

```
22A COPY COMBI
COMB 00 1-8 OK?
```

22A

LCD	Parameter	Range	Description
22A	Source Combination	00 – 99	Selects the Combination to copy.
	Destination Tracks	1–8, 9–16	Selects the eight destination tracks.
	OK to Copy from Combination	OK?	Executes Combination copy.

The following parameter settings are copied: Program, Volume, Transpose, Detune, Pan, Send C, Send D, Key Window, Velocity Window, MIDI Channel, and Filters (Program Change, Damper Pedal, After Touch, Control Change).

The Combination's effect settings are not copied. Use 21A Copy Effect to copy the effect settings. (see page 117.)

For *C Bend Range parameters that are not included in Combinations, the value of Program's Joystick Pitch Bend Range (15D in Program Edit mode) of each Track will be copied.

23A Set To GM (Initialize for GM)

This function conforms a track to the GM (General MIDI) settings. It should be used when you want to make new GM data, or when you want to play back GM song data.

23A SET TO GM OK?

23A

LCD	Parameter	Range	Description
23A	OK to set Track to GM Mode	OK?	Sets song to GM mode.

Each track's parameters are set as follows. Track 10 is set for drums.

Parameter	Track 1 - 9 & 11 - 16	Track 10	
Program	G01: PIANO	G129 (GM kit)	* Changeable using MIDI
Level	127	127	
Pan	CNT	PRG	* Changeable using MIDI
Send C, D	2, 2	P, 0	* Changeable using MIDI
Transpose	0	0	* Changeable using MIDI
Detune	0	0	* Changeable using MIDI
Pitch Bend Range	+2	0	* Changeable using MIDI
Program Change Filter	ENA	ENA	
Damper Pedal Filter	ENA	ENA	
After Touch Filter	ENA	ENA	
Control Change Filter	ENA	ENA	
Key Window	C-1-G9	C-1-G9	
Velocity Window	1-127	1-127	
Effect 1	—	—	Hall
Effect 2	—	—	Chorus
Effect Placement	—	—	Parallel 3
MIDI Channel	1-9, 11-16	10	

- When a GM System On message (F0, 7E, nn, 09, 01, F7) is received, Multi 1 mode is selected and these parameters are set automatically.

These parameters are also set automatically when you turn the power on to the X5.

Effect Parameters

The X5 contains two digital multi-effects processors. Each processor can be set to produce one of 47 effects (they are called "Effect type"). The effects section consists of four inputs (A, B, C, D), two effects processors (Effect1, Effect2), two panpots (pan 3, 4) and two outputs (L/MONO, R). The X5 effects processors can be assigned any one of four placements. See "20A-20B Effect Placement" on page 115. Effects 1 to 37 are single effects, 38 and 39 are serial effects, and 40 to 47 are parallel effects. The parallel type effects allow you to use up to four independent effects simultaneously.

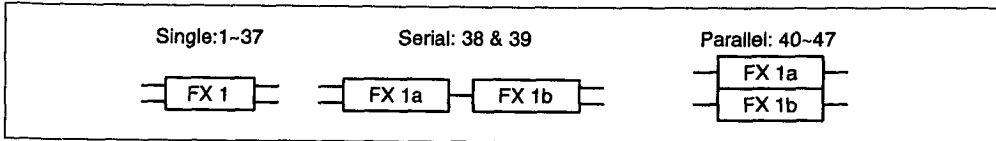

Effect parameters can be edited and stored with individual Programs, and Combinations. Effect parameters for a Program should be edited in Program Edit mode, and for Combination in Combination Edit mode.

When you play a Combination, the individual effect settings for each Program in that Combination are ignored, and the effect settings for that Combination are used. Likewise, for Multi setup, the individual Program effect settings are ignored and the effect settings for that particular Multi setup are used.

The page which the effect setting is made, is different with each mode.

- Program Edit mode (Single, Drums) 10A-15A
- Program Edit mode (Double) 16A-21A
- Combination Edit mode 9A-14A
- Multi mode 16A-21A

Here, we use Program Edit mode (Double) as an example.

When the power is turned on, when 23A SET TO GM in Multi mode is executed, or when a GM System On message is received. The following effect settings are made:

Placement—Parallel3.

Effect1—Hall.

Effect2—Chorus.

16A–16C Effect1 Setup

These parameters are used to set up Effect1.

16A EFFECT 1=01 Hall	16B Hall DRY:EFF=75:25	16C Hall Src:JS(+Y) I+10
16A	16B	16C

LCD	Parameter	Range	Description
16A	Effect Type (Effect1)	0–47	Select an effect type
	Switch	OFF, ON	Turn the effect on or off.
16B	Dry:Effect Balance (DRY:EFF)	DRY 99:1–1:99 FX	Dry signal only Dry:effect mix Effect signal only
16C	Dynamic Modulation Control Source (Src)	NONE JS(+Y) JS(-Y) AFTT PEDAL1 PEDAL2 VDA-EG	Dynamic modulation off JoyUp JoyDw After Touch Foot pedal1 Foot pedal2 (MIDI Controller No. 13) Sum of all 32 VDA EGs
	Dynamic Modulation Intensity (I)	-15...+15	Set the depth of dynamic modulation

16A Effect type: each time a different effect is selected, parameters that you set for the previously selected effect are reset to their initial values.

- When effect 24:Symphonic Ensemble is selected for one processor, certain effects cannot be selected for the other processor. See “Symphonic Ensemble” on page 127.

Switch: is used to turn the effects processors on and off. Effects processors can also be turned on and off using a foot pedal that is connected to the ASSIGNABLE PEDAL/SW connector. In Global mode, set the ASSIGNABLE PEDAL/SW parameter to “Effect 1 (2) on/off”. See “9A–9C Assignable Pedal/Switch & Polarity Setup” on page 161.

By sending MIDI Controller 92 for Effect1, and MIDI Controller 94 for Effect2, effects can be switched on and off by an external sequencer, or other MIDI device. Each time a Controller message is sent, the corresponding effect is switched on or off.

Note: *The high and low EQ for the following effects is valid even when the effect is set to OFF: 13:Stereo Delay, 14:Cross Delay, 19:Chorus 1, 20:Chorus 2, 28:Exciter, 35:Autopan, 36:Tremolo. To bypass these effects completely select 0: No Effect.*

16B Dry:Effect balance: this parameter allows you to set the level balance between the dry signal and effected signal. A setting of DRY means no affected signal. A setting of FX means all effect signal.

16C Dynamic modulation control source: allows you to adjust certain effect parameters, such as mix balance and modulation speed, while you play. This provides greater control for musical expression during a performance. The modulation source can be set to any one of six controls, such as a modulation wheel and foot pedal. You can control only one effect parameter using dynamic modulation, but the modulation source and intensity can be set independently for Effect1 and Effect2. See “Effects Types & Parameters” on page 118.

To control dynamic modulation using a foot pedal, set Pedal Assign in Global mode to Effect Control. See “9A–9C Assignable Pedal/Switch & Polarity Setup” on page 161. When a foot pedal that is connected to the ASSIGNABLE PEDAL connector is operated, MIDI Effect Control [Bn, 0C, vv] Controller 12 is output. This controls the effect whose dynamic modulation source is set to PEDAL1. MIDI Effect Control [Bn, 0D, vv] Controller 13 is transmitted when the dynamic modulation source is set to PEDAL2.

To control dynamic modulation via MIDI, set the MIDI Channel of the control source to that of the Global MIDI Channel.

Dynamic Modulation Intensity: the dynamic modulation intensity can be set from -15 to +15. Positive values cause dynamic modulation to increase the value of the effect parameter being controlled. Negative values have the opposite effect.

17A-17D Effect1 Parameters

Effect parameters are explained in detail from page 118 onwards.

18A-18C Effect2 Setup

These parameters are used to set up Effect2. Operation is the same as for "16A-16C Effect1 Setup" on page 114.

19A-19D Effect2 Parameters

Effect parameters are explained in detail from page 118 onwards.

20A-20B Effect Placement

20A PLACEMENT Serial	20B EFF2 PANPOT 3= L 4= R	20B' E1/E2 LEVEL L=5 R=5 L=5 R=5
20A	20B	20B'

LCD	Parameter	Range	Description
20A	Effect Placement	Serial (Serial) Parallel 1 (Parallel) Parallel 2 (Paralel2) Parallel 3 (Paralel3)	Effect routing configurations
20B	Panpot 3	OFF L 99:1-1:99 R	No signal output Signal is panned hard left Panned between L and R (50:50 pan center) Signal is panned hard right (this LCD screen appears when Serial, Parallel 1, or Parallel 2 is selected)
	Panpot 4		
20B'	Level 1L (L) Level 1R (R) Level 2L (L) Level 2R (R)	0-9	Set the output level of each effect when Parallel 3 is selected. (this LCD is available only when Parallel 3 placement is selected)

X5 effects processors can be used in any one of four placements. Placements affect the way in which the four input buses (A, B, C, D) are routed through the effects.

The Panpot, Send C Level, and Send D Level parameters are set as part of an individual Program, Combination, or Multi setup. If 20A Placement is set to serial, Parallel 1, or Parallel 2, Page 20B is displayed. In this page, you can set the L/R output balance of Pan 3 and Pan 4. If 20A is set to Parallel 3, Page 20B' appears. In this page, pan 3 and pan 4 are replaced by four independent level controls. The X5 has two outputs (L/MONO, R).

Serial Placement

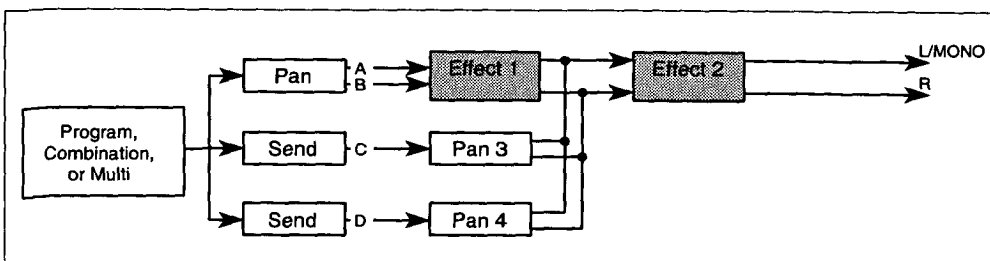

With the Serial placement, buses A and B are sent to Effect1, Effect2, then output from L/MONO and R. Buses C and D are mixed with the output of Effect1, sent to Effect2, and then output.

Buses C and D allow you to avoid applying Effect1 to a sound, or to apply Effect1 to a specific sound and then apply Effect2 to all sounds.

Parallel 1 Placement

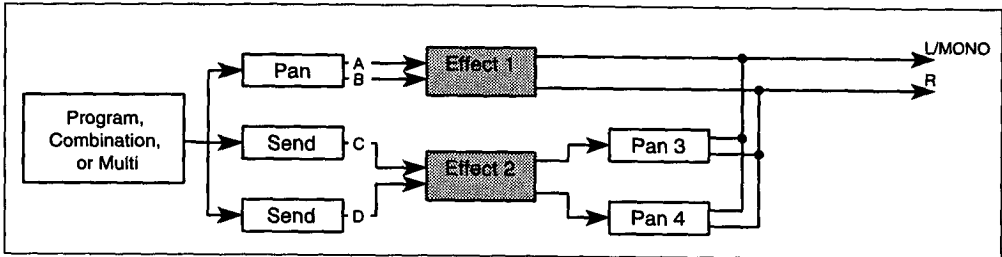

With the Parallel 1 placement, buses A and B are sent to Effect1, then output from L/MONO and R. Buses C and D are sent to Effect2, mixed with the output of Effect1, then output.

Parallel 2 Placement

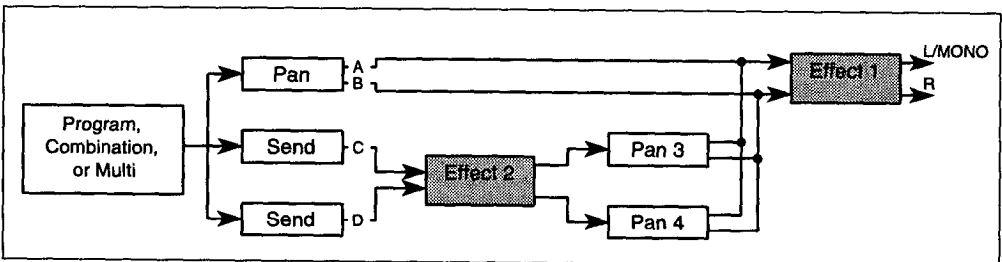

With the Parallel 2 placement, buses A and B are sent to Effect1, then output from L/MONO and R. Buses C and D are sent to Effect2, mixed with the input to Effect1, then output.

Parallel 3 Placement

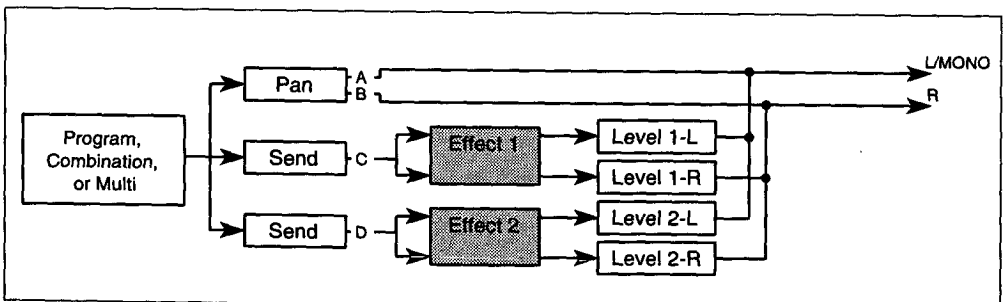

With the Parallel 3 placement, buses A and B are sent straight to the outputs. Bus C signal is sent to Effect1 and bus D signal is sent to Effect2. The effect outputs, each with independent level control, are then mixed down to the L/MONO and R outputs. This placement works well when playing GM compatible songs.

Note: For Serial, Parallel 1, and Parallel 2 placements, if Pan 3 or Pan 4 is set to off, signals sent to bus C and bus D are not output.

21A Copy Effects

This function allows you to copy the effect parameter settings from a Program, Combination, or song to the currently selected Program, Combination, or Multi setup.

```
21A COPY EFF
PROG A00 OK?
```

21A

LCD	Parameter	Range		Description
21A	Effect Copy Source	PROG COMBI MULTI		Select the effect copy source
	Source Number	Programs	A00–A99 G01–136	Select the source number
		Combinations	00–99	
	OK to copy	OK?		Executes effect copy

To copy effect parameters, select the effect copy source, the source number, position the cursor on OK?, then press the [▲/YES] button. The message “Are You Sure OK?” appears. Press the [▲/YES] button to continue, or the [▼/NO] button to cancel. The effect parameters are copied to the currently selected Program, Combination, or Multi. Pan, Send C, and Send D settings, which are set for oscillators, Timbres, and tracks, are not copied.

Effects Types & Parameters

Different parameters are available for different effects. Effect 0 (No Effect) through effect 47 (Delay/Rotary Speaker) can be selected for Effect1 and Effect2. Effect1 LCD screens are numbered 16A through 16D. Effect2 LCD screens are numbered 18A through 19D. Effect1 LCD screen numbers are used in this *Reference Guide*.

No Effect

0: No Effect

When NO EFFECT is selected, the effect processors are bypassed.

Effects can be turned off using “16A–16C Effect1 Setup” and “18A–18C Effect2 Setup”.

However, for some effects, the high and low EQ are still active. Selecting 0:No Effect allows you to bypass these effects completely.

Reverb

These effects simulate reverberant acoustics, adding ambience to the sound.

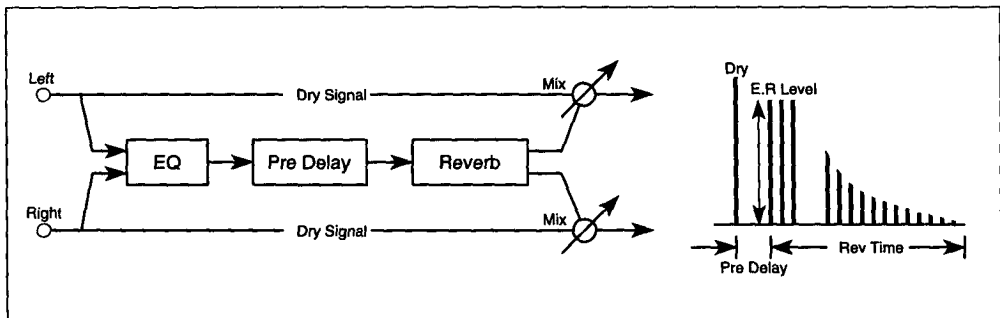

1: Hall

This effect simulates the reverb characteristics and natural ambience of a medium size hall.

2: Ensemble Hall

This effect simulates the reverb characteristics and natural ambience of an ensemble hall. Ideal for string and brass ensembles.

3: Concert Hall

This effect simulates the reverb characteristics and natural ambience of a large hall with pronounced early reflections.

4: Room

This effect simulates the reverb characteristics and natural ambience of a small room.

5: Large Room

This effect simulates the reverb characteristics and natural ambience of a large room with pronounced reverb density. Reverb time settings of about 0.5 seconds produce an effect similar to gated reverb.

6: Live Stage

This effect simulates the reverb characteristics and natural ambience of a large, live-performance space.

7: Wet Plate

This effect simulates the reverb characteristics of a steel-plate reverb, with pronounced density.

8: Dry Plate

This effect simulates the reverb characteristics of a steel-plate reverb, with a light density.

9: Spring Reverb

This effect simulates the reverb characteristics of a spring reverb.

17B Hall Time3.2 H.Dmp30	17B Hall P.Dly060ms E.R62	17C Hall EQ.L+04dB H+00dB
17A	17B	17C

LCD	Parameter	Range	Description
17A	Reverb Time (Time)	0.2–9.9 sec 0.2–4.9 sec 00–99	The time over which the reverb effect will last Hall type Room type Plate/spring type
	High Damp (H.Dmp)	0–99%	High frequency decay 0 = bright reverb 99 = dark reverb
17B	Pre Delay (P.Dly)	0–200 ms	The delay between the original sound and the early reflections
	Early Reflection Level (E.R)	0–99 1–10	The level of the early reflections Hall/Room type Plate/spring type
17C	EQ Low (EQ.L)	–12...+12 dB	Low EQ cut and boost
	EQ High (H)	–12...+12 dB	High EQ cut and boost

For effects 1 to 9, dynamic modulation (16C) can be used to control the DRY:EFF balance.

Early Reflection

The Early Reflection effects create the early reflections that are an important element in determining the qualities of an acoustic environment. Using the Early Reflection Time parameter you can create a variety of effects, such as sound thickening and echo-like reflections.

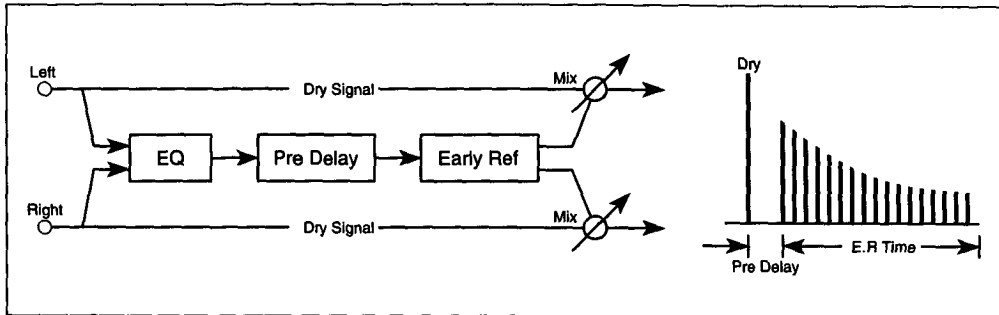

10: Early Reflection 1

Early reverb reflections are a crucial element of naturally occurring reverb. They transmit details such as room size, distance, acoustic damping, etc. This effect emphasizes the low frequency range, and is ideal for percussive sounds such as drums.

11: Early Reflection 2

This effect is similar to Early Reflection 1, although, the level of the early reflections change over time in a different way.

12: Early Reflection 3

This effect applies a reverse envelope to the early reflections. This produces an effect that is similar to playing a tape backwards, and it is ideally to sounds that have a fast attack such as crash cymbals.

17A EarlyRef1 E.R Time=220ms	17B EarlyRef1 Pre Delay= 015ms	17C EarlyRef1 EQ.L+03dB H+05dB
17A	17B	17C

LCD	Parameter	Range	Description
17A	Early Reflection Time (E.R Time)	100–800 ms	Early reflection time in 10 ms steps
17B	Pre Delay (Pre Delay)	0–200 ms	The delay between the original sound and the early reflections
17C	EQ Low (EQ.L)	-12...+12 dB	Low EQ cut and boost
	EQ High (H)	-12...+12 dB	High EQ cut and boost

For effects 10 to 12, dynamic modulation (16C) can be used to control the DRY:EFF balance.

Stereo Delay

These effects create stereo delay patterns in which you can set the left and right delay times independently. Using the High Damp parameter, you can make delays decay in a natural way.

13: Stereo Delay

This is a stereo delay effect with feedback. The delay time can be set independently for the left and right channels.

The high damp parameter can be used to produce a more natural echo effect by gradually attenuating the high frequencies of successive delay repeats.

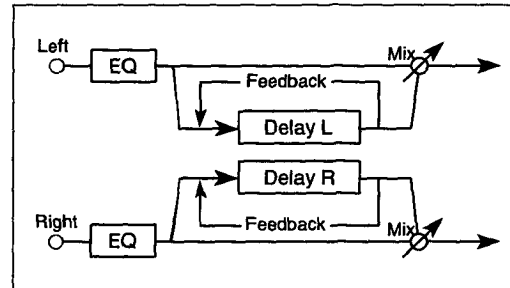

14: Cross Delay

This is a stereo delay effect with independent delay parameters for the left and right channels. The delay outputs are crossed over, and each delay receives the other delay's feedback signal. Thus, the delay repeats appear to move between the left and right outputs.

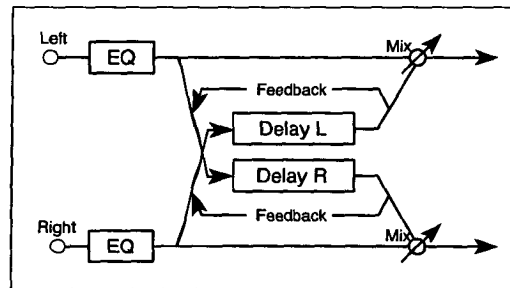

17A StereoD1y	17B StereoD1y	17C StereD1y
D.TimeL=250 R260	FB+40 H.Dmp=30	EQ.L+00dB H=00dB
17A	17B	17C

LCD	Parameter	Range	Description
17A	Delay Time Left (D.Time L)	0–500 ms	Delay time for the left channel
	Delay Time Right (R)	0–500 ms	Delay time for the right channel
17B	Feedback (FB)	–99...+99%	The amount of delay signal that is fed back into the effect. Minus values invert the feedback signal phase
	High Damp (H.Dmp)	0–99%	High frequency decay 0 = bright delay 99 = dark delay
17C	EQ Low (EQ.L)	–12...+12 dB	Low EQ cut and boost
	EQ High (H)	–12...+12 dB	High EQ cut and boost

For effects 13 and 14, dynamic modulation (16C) can be used to control the DRY:EFF balance. The EQ part of these effects is active even when the Effect is switched off (16A). To bypass these effects completely, select 0:No Effect.

Dual Mono Delay

15: Dual Mono Delay

This effect consists of two mono delays with independent delay time, feedback, and high damp parameters for each channel.

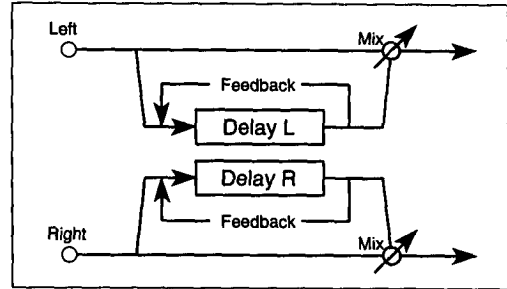

17A D.M D19(L) † D.Time=250ms	17B D.M D19(L) ‡ FB+50 H.Dmp=10	17C D.M D19(R) ‡ D.Time=250ms	17D D.M D19(R) † FB+50 H.Dmp=10
17A	17B	17C	17D

LCD	Parameter	Range	Description
17A	Delay Time Left (D.Time)	0-500 ms	Delay time for the left channel
17B	Feedback Left (FB)	-99...+99%	The amount of delay signal that is fed back into the left channel effect. Minus values invert the feedback signal phase
	High Damp Left (H.Dmp)	0-99%	High frequency damping for the left channel
17C	Delay Time Right (D.Time)	0-500 ms	Delay time for the right channel
17D	Feedback Right (FB)	-99...+99%	The amount of delay signal that is fed back into the left channel effect. Minus values invert the feedback signal phase
	High Damp Right (H.Dmp)	0-99%	High frequency damping for the right channel

For effect 15, dynamic modulation (16C) can be used to control the DRY:EFF balance.

Multi-Tap Delay

In these effects, an equalizer is applied to each effect input, then the signals are fed to two independent series-connected delays. The output of one delay is fed back to the input.

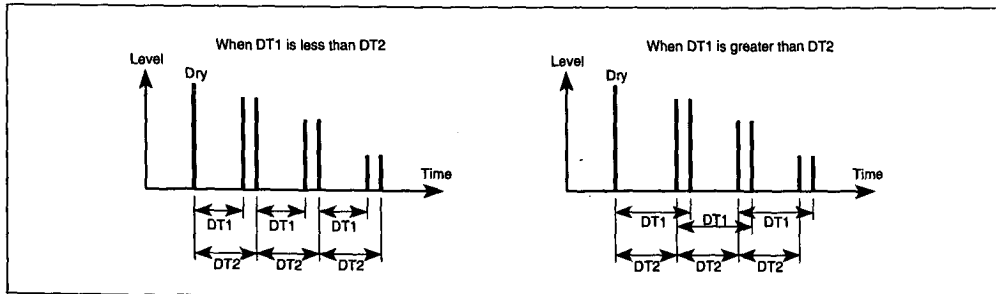

16: Multi-Tap Delay 1

This is a two-channel multi-repeat delay. It consists of two parallel delays for each channel. The delay time for each delay can be set independently. The output of delay 2 is fed back to the inputs of delay 1 and delay 2.

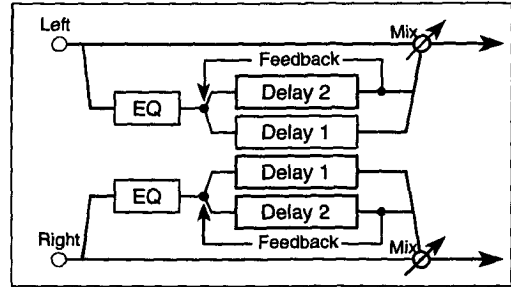

17: Multi-Tap Delay 2

This is a two-channel multi-repeat delay with cross panning.

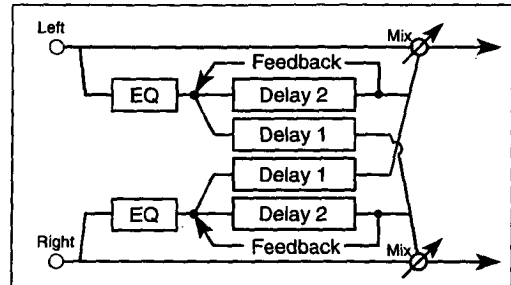

18: Multi-Tap Delay 3

This is a two-channel multi-repeat delay with crossed feedback.

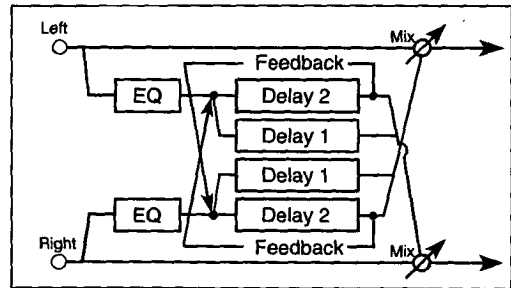

17A M.TapDly1 D1T300 D2T400	17B M.TapDly1 FB+50	17C M.TapDly1 EQ.L+00dB H+00dB
--------------------------------	------------------------	-----------------------------------

17A

17B

17C

LCD	Parameter	Range	Description
17A	Delay Time 1 (D1T)	0-500 ms	Delay time for delay 1
	Delay Time 2 (D2T)	0-500 ms	Delay time for delay 2
17B	Feedback (FB)	-99...+99%	The amount of delay signal that is fed back into the effect. Minus values invert the feedback signal phase
17C	EQ Low (EQ.L)	-12...+12 dB	Low EQ cut and boost
	EQ High (H)	-12...+12 dB	High EQ cut and boost

For effects 16, 17, and 18, dynamic modulation (16C) can be used to control the DRY:EFF balance.

Chorus

These are stereo-type effects that use two chorus units. They're an effective way to add spaciousness and depth to any type of sound: piano, strings, brass, etc.

19: Chorus 1

In this chorus effect, the left channel modulation signal is out of phase with the right channel modulation signal. This produces a wide stereo chorus effect.

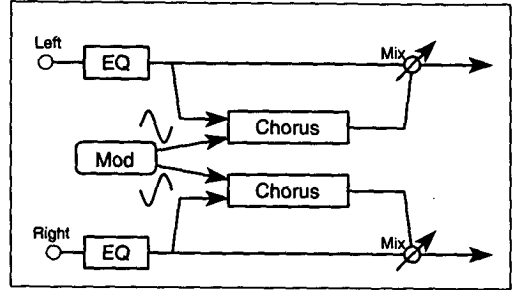

20: Chorus 2

In this chorus effect, left and right channel modulation signals are in phase.

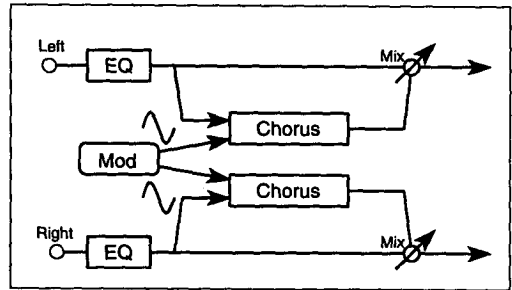

17A Chorus 1 D.Time=010ms TRI	17B Chorus 1 Mod60 M.SP0.30Hz	17C Chorus 1 EQ.L+00dB H+00dB
17A	17B	17C

LCD	Parameter	Range	Description
17A	Delay Time (D.Time)	0-200 ms	Delay time
	Mod Waveform	Sine (SIN) Triangle (TRI)	Modulation waveform type
17B	Mod Depth (Mod)	0-99	Modulation intensity
	Mod Speed (M.SP)	0.03-30 Hz	Modulation speed
17C	EQ Low (EQ.L)	-12...+12 dB	Low EQ cut and boost
	EQ High (H)	-12...+12 dB	High EQ cut and boost

For effects 19 and 20, dynamic modulation (16C) can be used to control the DRY:EFF balance. The EQ part of these effects is active even when the Effect is switched off (16A). To bypass these effects completely, select 0:No Effect.

21: Quadrature Chorus

The modulation signals fed to each channel of this stereo chorus effect are 90 degrees out of phase with each other.

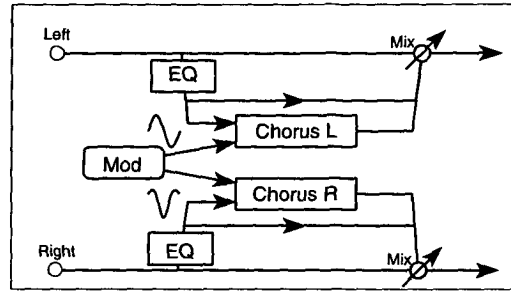

22: Crossover Chorus

The modulation signals fed to each channel of this stereo chorus effect are 90 degrees out of phase with each other. The chorused signals are mixed with the other channels output.

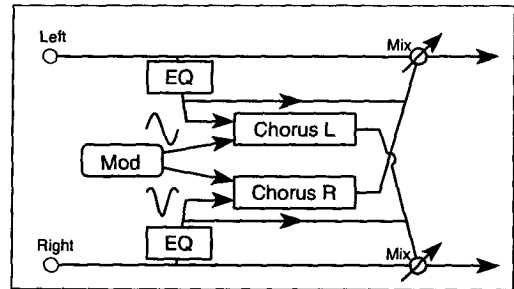

17A Quad.Cho D.Time L011 R023	17B Quad.Cho Mod50 ModSP=33	17C Quad.Cho ModShape=T+00	17D Quad.Cho EQ.L+00dB H+00dB
17A	17B	17C	17D

LCD	Parameter	Range	Description
17A	Delay Time L (D.TimeL)	0-250 ms	Left channel delay time
	Delay Time R (R)	0-250 ms	Right channel delay time
17B	Mod Depth (Mod)	0-99	Modulation depth
	Mod Speed (ModSP)	1-99	Modulation speed
17C	Mod Shape (ModShape)	T+10...T-10, S-10...S+10	Modulation waveform shape. T-Triangle, S-Sine. The range from +10 to -10 effects the waveform symmetry
17D	EQ Low (EQ.L)	-12...+12 dB	Low EQ cut and boost
	EQ High (H)	-12...+12 dB	High EQ cut and boost

For effects 21 and 22, dynamic modulation (16C) can be used to control the Mod Speed.

23: Harmonic Chorus

This effect splits the signal into two bands: HF (high frequency) and LF (low frequency). The HF band is then fed to the quadrature type chorus, and the LF band is fed directly to the output. This effect is useful for low frequency instruments such as bass.

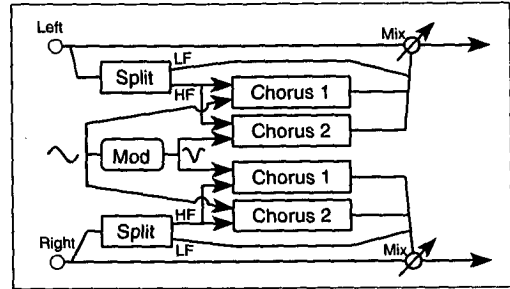

17A Harmo.Cho ▶ D1T004 D2T012	17B Harmo.Cho ▣ Mod99 ModeSP=35	17C Harmo.Cho ◀ F.Split Point=01
17A	17B	17C

LCD	Parameter	Range	Description
17A	Delay Time1 (D1T)	0-500 ms	Channel 1 delay time
	Delay Time 2 (D2T)	0-500 ms	Channel 2 delay time
17B	Mod Depth (Mod)	0-99	Modulation depth
	Mod Speed (ModSP)	1-99	Modulation speed
17C	Frequency Split Point (F.Split Point)	0-18	The frequency at which the input signal is split into HF and LF bands

For effect 23, dynamic modulation (16C) can be used to control the Mod Speed.

Symphonic Ensemble

24: Symphonic Ensemble

This effect is basically a multiple chorus type effect. It produces a rich, thickening effect, ideal for strings.

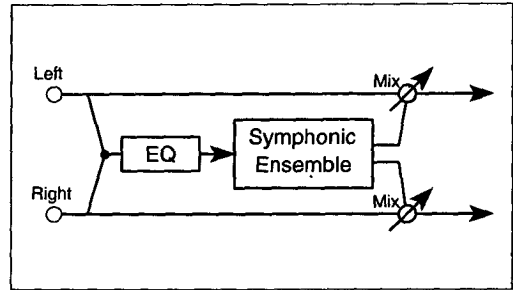

17A Symp. Ens. Mod88	17B Symp. Ens. EQ.L+00dB H=00db
17A	17B

LCD	Parameter	Range	Description
17A	Mod Depth (Mod)	0-99	Modulation depth
17B	EQ Low (EQ.L)	-12...+12 dB	Low EQ cut and boost
	EQ High (H)	-12...+12 dB	High EQ cut and boost

For effect 24, dynamic modulation (16C) can be used to control the DRY:EFF balance.

Note: When this effect is selected, the following effect types cannot be selected for the other effect: Choruses 19-23, Symphonic Ensemble 24, Flangers 25-27, Phasers 32-33, Rotary Speaker 34, Tremolos 35-36, Chorus Flanger/Delay 38-39, Delay/Chorus 42, Delay/Flanger 43, Delay/Phaser 46, and Delay/Rotary Speaker 47.

Flanger

These effects add feedback to a chorus effect. When used on sounds that contain a lot of high-frequency energy, such as cymbals, they not only create modulation effects, they add a sense of pitch to non-pitched sounds, too.

25: Flanger 1

In this effect, inphase modulation is fed to both flanger channels.

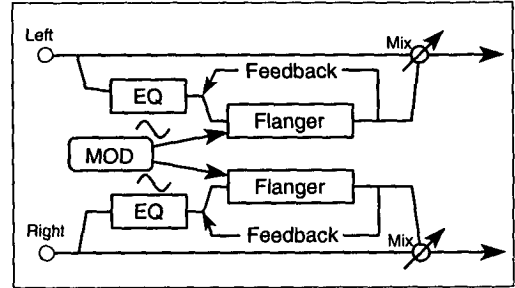

26: Flanger 2

In this effect, the left channel modulation signal is in phase and the right channel modulation signal is out of phase. This produces a wide, stereo flange effect.

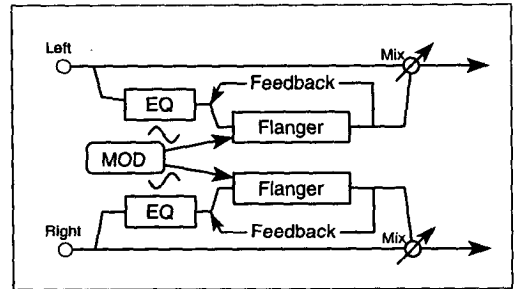

27: Crossover Flanger

In this effect, two flangers are modulated out of phase. The flanged output signals are mixed with the other channels output.

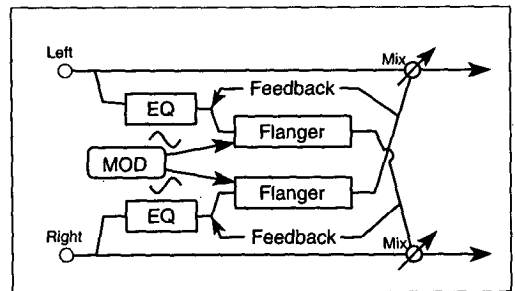

17A Flanger1	17B Flanger1	17C Flanger1
D.Time005 Res+85	Mod99 ModSP=20	EQ.L+00dB H+00dB

17A

17B

17C

LCD	Parameter	Range	Description
17A	Delay Time (D.Time)	0–200 ms	Delay time
	Resonance (Res)	–99...+99	Amount of output signal fed back to the input (feedback)
17B	Mod Depth (Mod)	0–99	Modulation depth
	Mod Speed (ModSP)	1–99	Modulation speed
17C	EQ Low (EQ.L)	–12...+12 dB	Low EQ cut and boost
	EQ High (H)	–12...+12 dB	High EQ cut and boost

For effects 25 to 27, dynamic modulation (16C) can be used to control the Mod Speed.

Exciter

28: Exciter

This effect increases the clarity of a sound and gives it greater definition.

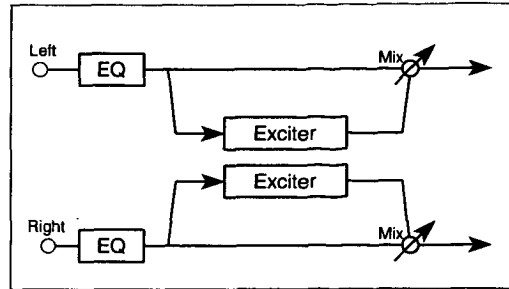

17A Exciter Blend=+50	17B Exciter Emph Point=05	17C Exciter EQ.L+04dB H=00dB
17A	17B	17C

LCD	Parameter	Range	Description
17A	Blend (Blend)	-99...+99	Mix of dry and effected signal
17B	Emphatic Point (Emph Point)	1-10	The central frequency around which sounds are excited
17C	EQ Low (EQ.L)	-12...+12 dB	Low EQ cut and boost
	EQ High (H)	-12...+12 dB	High EQ cut and boost

For effect 28, dynamic modulation (16C) can be used to control the DRY:EFF mix level.

The EQ sections of this effect are active even when the effect is switched OFF. To bypass this effect completely, select 0:No Effect.

Enhancer

29: Enhancer

This is a two-channel enhancer that includes a delay to give a sound more spaciousness. An enhancer makes the sound clearer and more defined, giving the sound more presence and bringing it up front in the mix.

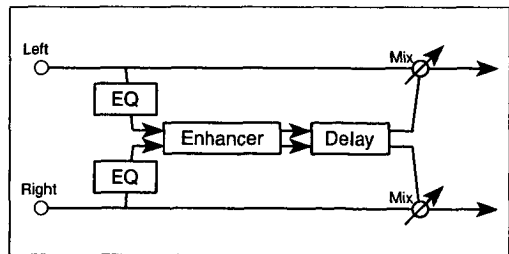

17A Enhancer Harm Density=80	17B Enhancer Hot Spot=01	17C Enhancer S.W=50 D.Time=25	17D Enhancer EQ.L+01dB H+01dB
17A	17B	17C	17D

LCD	Parameter	Range	Description
17A	Harmonic Density	1-99	Level of the enhanced signal
17B	Hot Spot	1-20	The central frequency around which sounds are enhanced
17C	Stereo Width (S.W)	0-99	The width of the stereo image that is opened up by the delay
	Delay Time (D.Time)	1-99	Delay time
17D	EQ Low (EQ.L)	-12...+12 dB	Low EQ cut and boost
	EQ High (H)	-12...+12 dB	High EQ cut and boost

For effect 29, dynamic modulation (16C) can be used to control the DRY:EFF balance.

Distortion

30: Distortion

This effect can provide everything from subtle distortion through to mega-power distortion—ideal for ripping solos. The Hot Spot and Resonance parameters allow you to tune in for a wah type effect, and the Hot Spot parameter can be controlled in real time using dynamic modulation.

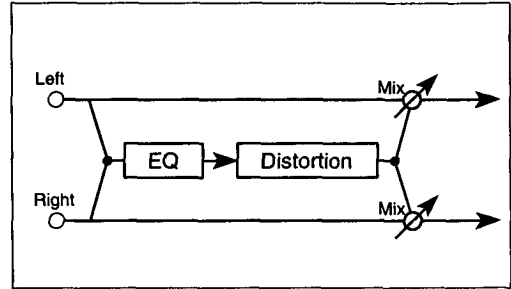

31: Overdrive

This effect produces a smooth overdrive. As with the previous distortion effect, dynamic modulation allows real-time control of the wah filter's Hot Spot parameter.

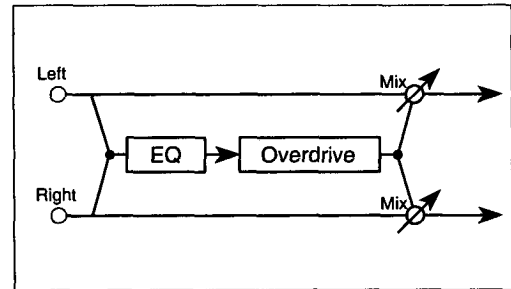

17A Dist Drive=111 Res=00	17B Dist H.Spot=05 Level=10	17C Dist EQ.L+02dB H+12dB
17A	17B	17C

LCD	Parameter	Range	Description
17A	Drive (Drive)	1–111	Distortion/Overdrive level
	Resonance (Res)	0–99	Gain of the resonant wah filter
17B	Hot Spot (H.Spot)	0–99	Wah filter centre frequency
	Out Level (Level)	0–99	Distortion output level
17C	EQ Low (EQ.L)	–12...+12 dB	Low EQ cut and boost
	EQ High (H)	–12...+12 dB	High EQ cut and boost

For effects 30 and 31, dynamic modulation (16C) can be used to control the Hot Spot parameter. This is useful for creating a wah-wah type effect.

Phaser

These are two-channel stereo phase shifters. Using delay and phase changes, they produce a modulation effect that is clearer than chorus or flanger. These effects are especially suitable for electric piano and guitar. Chorus and flanger produce their effects by modulating the delay time. However, phasers, modulate the phase of the input signal, creating an effect that has a different character to that of chorus or flanger.

32: Stereo Phaser 1

In Phaser 1, the left channel modulation signal is in phase and the right channel modulation signal is out of phase. This produces a wide stereo phaser effect.

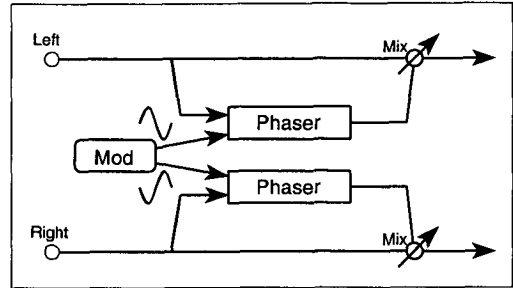

33: Stereo Phaser 2

This stereo effect contains two phasers. In-phase modulation is fed to both channels.

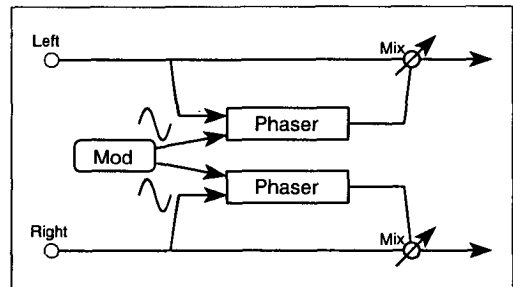

17A Phaser 1 Manual=99	17B Phaser 1 Mod60 M.SP0.69Hz	17C Phaser 1 FB+75 SIN
17A	17B	17C

LCD	Parameter	Range	Description
17A	Manual (Manual)	0-99	The central frequency around which phase shifting is concentrated
17B	Mod Depth (Mod)	0-99	Modulation depth
	Mod Speed (M.SPO.)	0.03-30 Hz	Modulation speed
17C	Feedback (FB)	-99...+99%	The amount of phased signal that is fed back into the effect. Minus values invert the feedback signal phase
	Mod Waveform	Sine (SIN) Triangle (TRI)	Modulation waveform

For effects 32 and 33, dynamic modulation (16C) can be used to control the Mod Speed.

Rotary Speaker

This effect simulates the rotary speaker effect that is popular for organs.

34: Rotary Speaker

The effect is popular with organ type sounds. The rotation speed continuously cycles between the two speed settings at a rate determined by the Acceleration parameter.

Dynamic modulation can be used to switch from slow to fast speed. The rotor speed will change at a rate specified by the Acceleration parameter regardless of how rapidly you move the dynamic modulation controller.

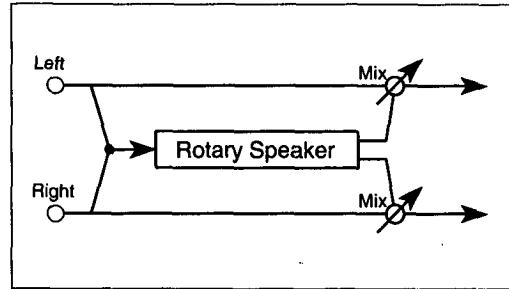

17A Rot.Spk Vibrato Depth=09	17B Rot.Spk Acceleration=04	17C Rot.Spk Speed S=25 F=70
---------------------------------	--------------------------------	--------------------------------

17A

17B

17C

LCD	Parameter	Range	Description
17A	Vibrato Depth (Vibrato Depth)	0-15	Effect depth
17B	Acceleration (Acceleration)	1-15	Time taken to change from one speed to the other
17C	Slow Speed (S)	1-99	Slow rotation speed
	Fast Speed (F)	1-99	Fast rotation speed

For effect 34, dynamic modulation (16C) can be used to switch from slow to fast speed.

Tremolo

This effect cyclically varies the volume.

35: Auto Pan

This effect pans the signal continuously across the stereo image. The speed of panning (Mod Speed) can be set relative to song tempo, or left to produce a natural drift across the stereo image.

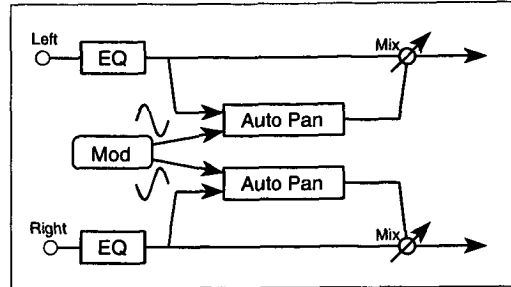

36: Tremolo

The tremolo effect modulates the signal amplitude to produce regular variations in volume level.

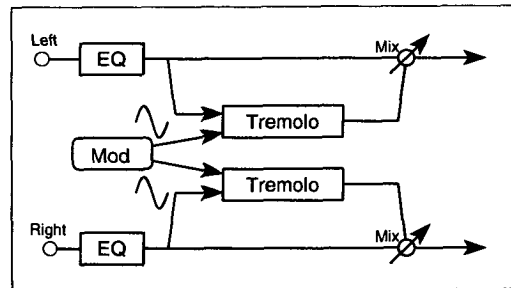

17A Auto Pan SIN ModShape+99	17B Auto Pan Mod80 M.SP1.59Hz	17C Auto Pan EQ.L+00dB H+00dB
---------------------------------	----------------------------------	----------------------------------

17A

17B

17C

LCD	Parameter	Range	Description
17A	Mod Waveform	Sine (SIN) Triangle (TRI)	Modulation waveform
	Mod Shape (Mod Shape)	-99...+99	
17B	Mod Depth (Mod)	0-99	Modulation depth
	Mod Speed (M.SP)	0.03-30 Hz	Modulation speed
17C	EQ Low (EQ.L)	-12...+12 dB	Low EQ cut and boost
	EQ High (H)	-12...+12 dB	High EQ cut and boost

For effects 35 and 36, dynamic modulation (16C) can be used to control the DRY:EFF balance.

The EQ sections of this effect are active even when the effect is switched OFF. To bypass this effect completely, select 0:No Effect.

Parametric EQ

37: Parametric EQ

This is a 3-band parametric equalizer, with independent gain and frequency controls for each band. The width of the mid-frequency band is variable.

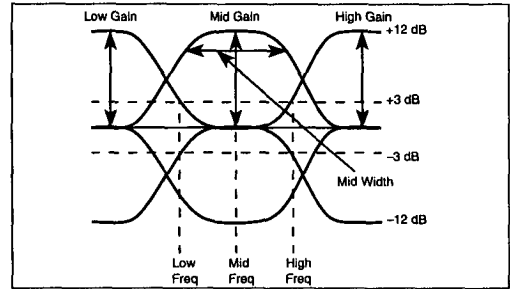
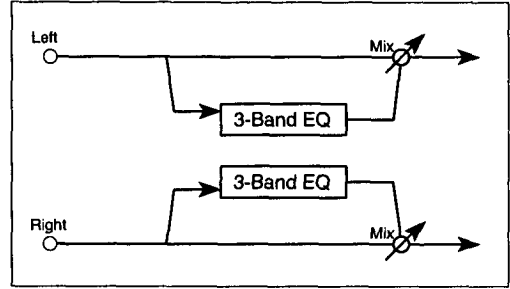

17A Para. EQ LowFr=12 Gain+12	17B Para. EQ MidFr=08 Gain+12	17C Para. EQ MidWidth=58	17D Para. EQ Hi Fr=20 Gain+12
17A	17B	17C	17D

LCD	Parameter	Range	Description
17A	Low Freq (LowFrq)	0-29	Low cutoff frequency
	Low Gain (Gain)	-12...+12 dB	Low EQ cut and boost
17B	Mid Freq (MidFrq)	0-99	Mid center frequency
	Mid Gain (Gain)	-12...+12 dB	Mid EQ cut and boost
17C	Mid Width (MidWidth)	0-99	Mid band width
17D	High Freq (Hi Frq)	0-29	High cutoff frequency
	High Gain (Gain)	-12...+12 dB	High EQ cut and boost

For effect 37, dynamic modulation (16C) can be used to control the Mid Freq parameter. This is useful for creating a wah type effect.

Combination Effects: Serial

Effects 38 and 39 use mono input–stereo output chorus/flangers in series with stereo delays.

38: Chorus–Delay

This effect consists of a chorus and delay in series. The input signals are summed, then fed to two chorus units. The modulation signals fed to each chorus are 90 degrees out of phase with each other. Feedback parameters are available for both chorus and delay.

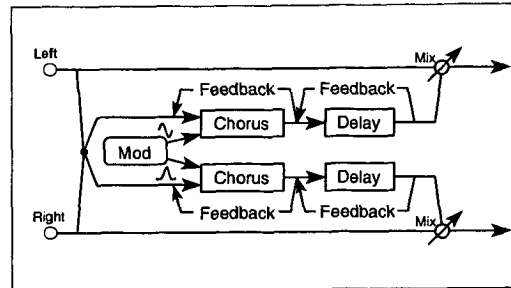

39: Flanger–Delay

This effect consists of a flanger and delay in series. The input signals are summed, then fed to two flanger units. The modulation signals fed to each flanger are 90 degrees out of phase with each other. Feedback parameters are available for both flanger and delay.

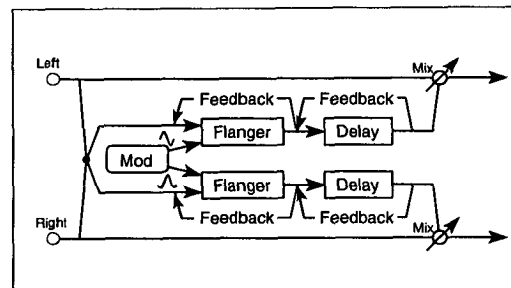

17A Chor-Dly	17B Chor-Dly	17C Chor-Dly
Cho.DT11ms FB+10	Cho.Mod50 M.SP30	Dly.DT110 FB-10

17A

17B

17C

Chorus, Flanger

LCD	Parameter	Range	Description
17A	Delay Time (Cho.DT)	0–50 ms	Chorus/Flanger delay time
	Feedback (FB)	–99...+99%	The amount of effected signal that is fed back into the effect. Minus values invert the feedback signal phase
17B	Mod Depth (Cho.Mod)	0–99	Modulation depth
	Mod Speed (M.SP)	1–99	Modulation speed

Delay

LCD	Parameter	Range	Description
17C	Delay Time (Dly.DT)	0–450 ms	Delay time (set in 2 ms steps)
	Delay Feedback (FB)	–99...+99%	The amount of delay signal that is fed back into the effect. Minus values invert the feedback signal phase

For effects 38 and 39, dynamic modulation (16C) can be used to control the DRY:EFF balance.

Combined Effects: Parallel

Effects 40 to 47 are arranged in parallel. This means that two signals can be fed independently to two separate effects. For Example, with effect 40 (Delay/Hall Reverb), the left channel feeds a delay, while the right channel feeds a hall reverb.

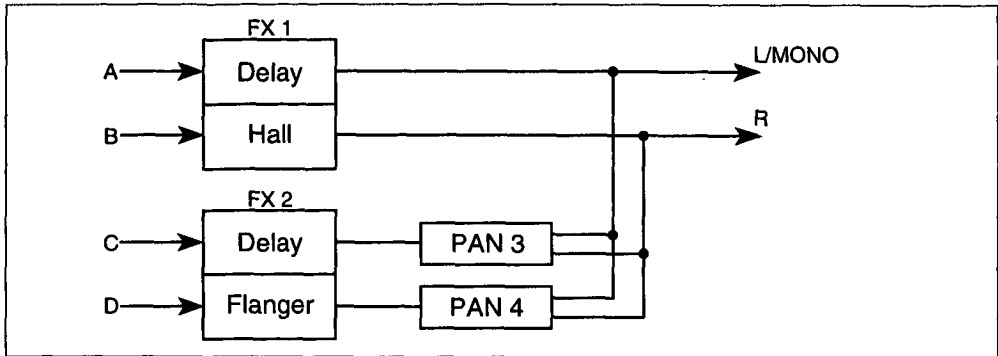

For details about the individual effects used in these combined effects, refer to the descriptions for effects 1 to 34.

Mono Delay/Reverb

40: Delay/Hall Reverb

This effect consists of two independent effects: delay on the left channel and hall type reverb on the right.

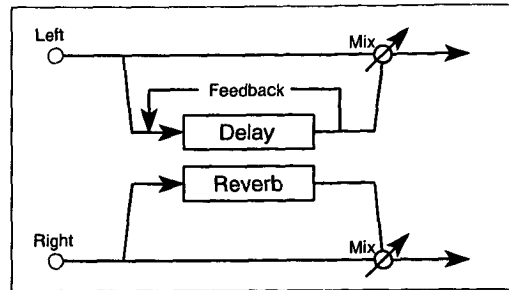

41: Delay/Room Reverb

This effect consists of two independent effects: delay on the left channel and room type reverb on the right.

17A Delay(L) Time250ms FB+50	17B Delay(L) H.Dmp10	17C Hall(R) Time3.5s H.Dmp40	17D Hall(R) P.Dly055ms
17A	17B	17C	17D

Delay

LCD	Parameter	Range	Description
17A	Delay Time (Time)	0–500 ms	Delay time
	Feedback (FB)	–99...+99%	The amount of delay signal that is fed back into the effect. Minus values invert the feedback signal phase
17B	High Damp (H.Dmp)	0–99%	High frequency decay

Hall, Room

LCD	Parameter	Range	Description
17C	Reverb Time (Time)	0.2–9.9 sec (Hall)	The time over which the reverb effect will last
		0.2–4.9 sec (Room)	
	High Damp (H.Dmp)	0–99%	High frequency decay 0 = bright reverb 99 = dark reverb
17D	Pre Delay (P.Dly)	0–150 ms	The delay between the original sound and the early reflections

For effects 40 and 41, dynamic modulation (16C) can be used to control the DRY:EFF balance.

Mono Delay/Modulated Delay

42: Delay/Chorus

This effect consists of two independent effects: delay on the left channel and chorus on the right.

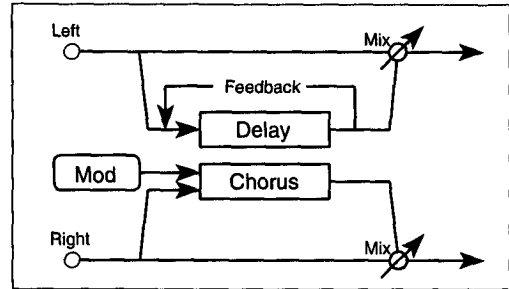

17A Delay(L) ▶ Time250ms FB+50	17B Delay(L) ⌘ H.Dmp10	17C Chorus(R) ⌘ Mod60 M.SP0.30Hz	17D Chorus(R) ⌘ TRI
17A	17B	17C	17D

Delay

LCD	Parameter	Range	Description
17A	Delay Time (Time)	0–500 ms	Delay time
	Feedback (FB)	–99...+99%	The amount of delay signal that is fed back into the effect. Minus values invert the feedback signal phase
17B	High Damp (H.Dmp)	0–99%	High frequency decay

Chorus

LCD	Parameter	Range	Description
17C	Mod Depth (Mod)	0–99%	Modulation depth
	Mod Speed (M.SP)	0.03–30 Hz	Modulation speed
17D	Mod Waveform	Sine (SIN) Triangle (TRI)	Modulation waveform

For effect 42, dynamic modulation (16C) can be used to control the DRY:EFF balance.

43: Delay/Flanger

This effect consists of two effects: delay on the left channel and flanger on the right.

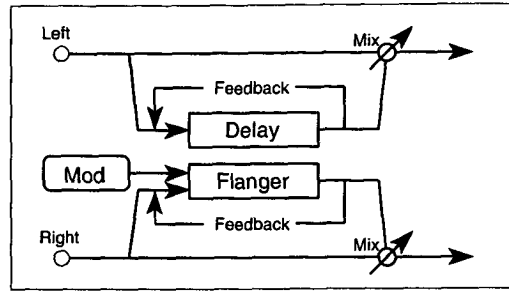

17A Delay(L) Time250ms FB+50	17B Delay(L) H.Dmp=10	17C Flanger(R) Mod70 M.SP0.18Hz	17D Flanger(R) FB-75
17A	17B	17C	17D

Delay

LCD	Parameter	Range	Description
17A	Delay Time (Time)	0-500 ms	Delay time
	Feedback (FB)	-99...+99%	The amount of delay signal that is fed back into the effect. Minus values invert the feedback signal phase
17B	High Damp (H.Dmp)	0-99%	High frequency decay

Flanger

LCD	Parameter	Range	Description
17C	Mod Depth (Mod)	0-99%	Modulation depth
	Mod Speed (M.SP)	0.03-30 Hz	Modulation speed
17D	Feedback (FB)	-99...+99%	The amount of effected signal that is fed back into the effect. Minus values invert the feedback signal phase

For effect 43, dynamic modulation (16C) can be used to control the DRY:EFF balance.

Mono Delay/Distortion, Overdrive

44: Delay/Distortion

This effect consists of two effects: delay on the left channel and distortion on the right.

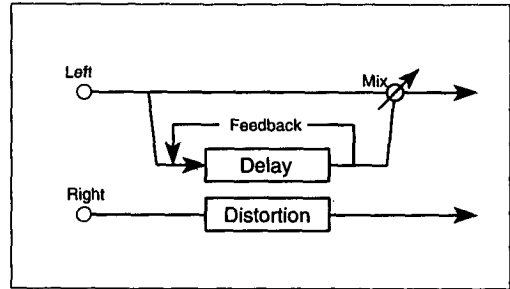

45: Delay/Overdrive

This effect consists of two effects: delay on the left channel and overdrive on the right.

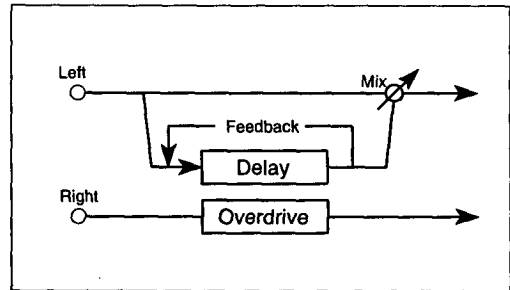

17A Delay(L) Time250ms FB+40	17B Dist(R) Drive=111 Res=75	17C Dist(R) H.Spot50 Level105
17A	17B	17C

Delay

LCD	Parameter	Range	Description
17A	Delay Time (Time)	0-500 ms	Delay time
	Feedback (FB)	-99...+99%	The amount of delay signal that is fed back into the effect. Minus values invert the feedback signal phase

Distortion, Overdrive

LCD	Parameter	Range	Description
17B	Drive (Drive)	1-111	Distortion/Overdrive level
	Resonance (Res)	0-99	Gain of the resonant wah filter
17C	Hot Spot (H.Spot)	1-99	The wah filter frequency where it all happens
	Level (Level)	1-99	Distortion output level

Mono Delay/Phaser

46: Delay/Phaser

This effect consists of two effects: delay on the left channel and phaser on the right.

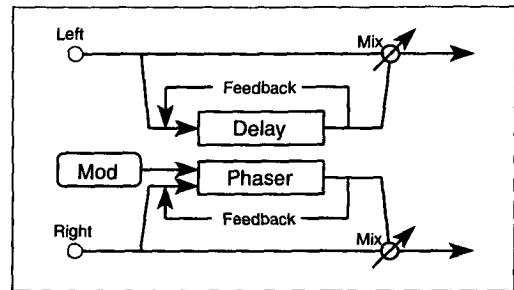

17A Delay(L) ↑ Time250ms FB+50	17B Delay(L) ↓ H.Dmp10	17C Phaser(R) ↓ Mod60 M.SP0.69Hz	17D Phaser(R) ↑ FB-75
17A	17B	17C	17D

Delay

LCD	Parameter	Range	Description
17A	Delay Time (Time)	0-500 ms	Delay time
	Feedback (FB)	-99...+99%	The amount of delay signal that is fed back into the effect. Minus values invert the feedback signal phase
17B	High Damp (H.Dmp)	0-99%	High frequency decay

Phaser

LCD	Parameter	Range	Description
17C	Mod Depth (Mod)	0-99%	Modulation depth
	Mod Speed (M.SP)	0.03-30 Hz	Modulation speed
17D	Feedback (FB)	-99...+99%	The amount of phased signal that is fed back into the effect. Minus values invert the feedback signal phase

For effect 46, dynamic modulation (16C) can be used to control the DRY:EFF balance.

Mono Delay/Rotary

47: Delay/Rotary Speaker

This effect consists of two effects: delay on the left channel and rotary speaker on the right.

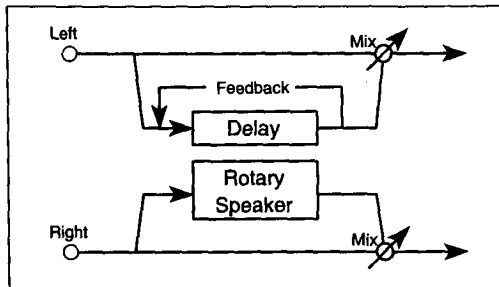

17A Delay(L) Time250ms FB+40	17B Rot.SP(L) Acceleration=04	17C Rot.SP(R) Speed S=25 F=70
---------------------------------	----------------------------------	----------------------------------

17A

17B

17C

Delay

LCD	Parameter	Range	Description
17A	Delay Time (Time)	0-500 ms	Delay time
	Feedback (FB)	-99...+99%	The amount of delay signal that is fed back into the effect. Minus values invert the feedback signal phase

Rotary Speaker

LCD	Parameter	Range	Description
17B	Acceleration (Acceleration)	1-15	Time taken to change from one speed to the other
17C	Slow Speed (S)	1-99	Slow rotation speed
	Fast Speed (F)	1-99	Fast rotation speed

For effect 47, dynamic modulation (16C) can be used to switch the speed change direction.

Effect Parameter Table

REVERB		Reverb Time	Pre Delay	E.R Level
1	Hall	0.2~9.9 [2.3]	0~200 [60]	0~99 [62]
2	Ensemble Hall	◇ [3.1]	◇ [15]	◇ [23]
3	Concert Hall	◇ [3.3]	◇ [80]	◇ [46]
4	Room	0.2~4.9 [1.3]	◇ [8]	◇ [68]
5	Large Room	◇ [2.4]	◇ [25]	◇ [51]
6	Live Stage	◇ [2.2]	◇ [12]	◇ [81]
7	Wet Plate	0~99 [59]	◇ [29]	1~10 [7]
8	Dry Plate	◇ [30]	◇ [26]	◇ [5]
9	Spring Reverb	◇ [25]	◇ [0]	◇ [9]
EARLY REFLECTION		E.R Time	Pre Delay	
10	Early Reflection 1	100~800 [220]	0~200 [10]	
11	◇ 2	◇ [180]	◇ [30]	
12	◇ 3	◇ [300]	◇ [90]	
STEREO DELAY		Delay Time L	Delay Time R	Feedback
13	Stereo Delay	0~500 [185]	0~500 [370]	-99~+99 [-40]
14	Cross Delay	◇ [190]	◇ [380]	◇ [+40]
DUAL MONO DELAY		Delay Time L	Feedback L	High Damp L
15	Dual Mono Delay	0~500 [20]	-99~+99 [0]	0~99 [0]
MULTI TAP DELAY		Delay Time		
16	Multi Tap Delay 1	0~500 [175]	0~500 [350]	
17	◇ 2	◇ [200]	◇ [400]	
18	◇ 3	◇ [250]	◇ [500]	
CHORUS		Delay Time	Mod Speed	Mod Depth
19	Stereo Chorus 1	0~200 [3]	0.03~30 [0.33]	0~99 [99]
20	◇ 2	◇ [2]	◇ [0.42]	◇ [84]
CHORUS		Delay Time L	Delay Time R	Mod Speed
21	Quadrature Chorus	0~250 [24]	0~250 [12]	● 1~99 [30]
22	Cross Over Chorus	◇ [2]	◇ [24]	● " [16]
HARMONIC CHORUS		Delay Time L	Delay Time R	
23	Harmonic Chorus	0~500 [4]	0~500 [12]	
SYMPHONIC ENSEMBLE		Mod Depth		
24	Symphonic Ensemble	0~99 [92]		
FLANGER		Delay Time	Mod Depth	Mod Speed
25	Flanger 1	0~200 [5]	0~99 [50]	● 1~99 [20]
26	◇ 2	◇ [24]	◇ [99]	● " [42]
27	Cross Over Flanger	◇ [1]	◇ [60]	● " [22]
EXCITER		Blend		Emphatic Point
28	Exciter	-99~+99 [+60]		1~10 [01]
ENHANCER		Harmonic Density	Hot Spot	Stereo Width
29	Enhancer	1~99 [28]	1~20 [3]	0~99 [85]
DISTORTION		Drive	Hot Spot	Resonance
30	Distortion	1~111 [107]	● 0~99 [99]	0~99 [07]
31	Over Drive	◇ [85]	● " [70]	◇ [63]
PHASER		Manual	Mod Speed	Mod Depth
32	Stereo Phaser 1	0~99 [98]	● 0.03~30 [0.24]	0~99 [90]
33	◇ 2	◇ [96]	● ~ [0.24]	◇ [90]
ROTARY SPEAKER		Vibrato Depth		Acceleration
34	Rotary Speaker	0~15 [2]		1~15 [12]
TREMOLO		Mod Waveform	Mod Wave Shape	Mod Speed
35	Auto Pan	SIN, TRI [TRI]	-99~+99 [+96]	0.03~30 [0.21]
36	Tremolo	◇ [TRI]	◇ [-99]	◇ [3.9]
PARAMETRIC EQ		Low Freq	Low Gain	Mid Freq
37	Parametric EQ	0~29 [15]	-12~+12 [+06]	● 0~99 [50]
COMBINATION SERIAL		Fig / Cho Delay	Fig / Cho F-Back	Mod Speed
38	Chorus-Delay	0~50 [24]	-99~+99 [+24]	1~99 [12]
39	Flanger-Delay	◇ [1]	◇ [+80]	◇ [04]
COMBINATION PARALLEL		Delay Time	Feedback	High Damp
40	Delay / Hall	0~500 [30]	-99~+99 [0]	0~99 [0]
41	Delay / Room	◇ [20]	◇ [0]	◇ [0]
42	Delay / Chorus	0~500 [220]	-99~+99 [+15]	0~99 [50]
43	Delay / Flanger	0~500 [400]	-99~+99 [+20]	0~99 [60]
44	Delay / Distortion	0~500 [250]	-99~+99 [+40]	
45	Delay / Over Drive	◇ [350]	◇ [+50]	
46	Delay / Phaser	0~500 [300]	-99~+99 [+15]	0~99 [60]
47	Delay / Rotary Speaker	0~500 [280]	-99~+99 [+15]	

([] : Initial Value ● : Dynamic Mod Dest

High Damp		EQ Low	EQ High	Dry : FX Balance
0~99 [31]		-12~+12 [-3]	-12~+12 [-1]	●DRY~FX [80:20]
" [32]		" [-1]	" [-3]	● " [80:20]
" [41]		" [-2]	" [-4]	● " [80:20]
" [36]		" [+1]	" [+2]	● " [78:22]
" [32]		" [-1]	" [+2]	● " [78:22]
" [36]		" [-5]	" [-4]	● " [75:25]
" [51]		" [0]	" [-4]	● " [80:20]
" [47]		" [+2]	" [+2]	● " [80:20]
" [30]		" [+2]	" [-4]	● " [78:22]
		EQ Low	EQ High	Dry : FX Balance
		-12~+12 [-4]	-12~+12 [-4]	●DRY~FX [68:32]
		" [+1]	" [0]	● " [65:35]
		" [0]	" [0]	● " [75:25]
High Damp		EQ Low	EQ High	Dry : FX Balance
0~99 [10]		-12~+12 [0]	-12~+12 [0]	●DRY~FX [80:20]
" [10]		" [0]	" [0]	● " [80:20]
Dry : FX Balance L	Delay Time R	Feedback R	High Damp R	Dry : FX Balance R
DRY~FX [50:50]	0~500 [40]	-99~+99 [0]	0~99 [10]	●DRY~FX [35:65]
Feedback		EQ Low	EQ High	Dry : FX Balance
-99~+99 [+30]		-12~+12 [0]	-12~+12 [0]	●DRY~FX [80:20]
" [0]		" [0]	" [0]	● " [70:30]
" [+20]		" [0]	" [0]	● " [75:25]
Mod Waveform		EQ Low	EQ High	Dry : FX Balance
SIN, TRI [TRI]		-12~+12 [+4]	-12~+12 [+4]	●DRY~FX [50:50]
" [SIN]		" [+3]	" [+4]	● " [60:40]
Mod Depth	Mod Waveform	EQ Low	EQ High	Dry : FX Balance
0~99 [50]	T+10~S+10 [T+0]	-12~+12 [0]	-12~+12 [0]	DRY~FX [50:50]
" [99]	" [T+0]	" [0]	" [0]	" [50:50]
Mod Speed	Mod Depth	Filter Split Point		Dry : FX Balance
●1~99 [36]	0~99 [99]	0~18 [3]		DRY~FX [25:75]
		EQ Low	EQ High	Dry : FX Balance
		-12~+12 [0]	-12~+12 [0]	●DRY~FX [67:33]
	Resonance	EQ Low	EQ High	Dry : FX Balance
	-99~+99 [+80]	-12~+12 [0]	-12~+12 [0]	DRY~FX [50:50]
	" [+36]	" [0]	" [0]	" [50:50]
	" [+80]	" [0]	" [0]	" [50:50]
		EQ Low	EQ High	Dry : FX Balance
		-12~+12 [+3]	-12~+12 [+3]	●DRY~FX [50:50]
Delay Time		EQ Low	EQ High	Dry : FX Balance
1~99 [25]		-12~+12 [0]	-12~+12 [0]	●DRY~FX [50:50]
EQ Low	EQ High	Out Level		Dry : FX Balance
-12~+12 [0]	-12~+12 [0]	0~99 [6]		DRY~FX [50:50]
" [0]	" [0]	" [8]		" [50:50]
Feedback	Mod Waveform			Dry : FX Balance
-99~+99 [96]	SIN, TRI [TRI]			DRY~FX [50:50]
" [90]	" [SIN]			" [50:50]
	Slow Speed		Fast Speed	Dry : FX Balance
	1~99 [25]		1~99 [69]	DRY~FX [34:66]
Mod Depth		EQ Low	EQ High	Dry : FX Balance
0~99 [96]		-12~+12 [0]	-12~+12 [0]	●DRY~FX [20:80]
" [99]		" [0]	" [0]	● " [50:50]
Mid Gain	Mid Width	High Freq	High Gain	Dry : FX Balance
-12~+12 [+6]	0~99 [50]	0~29 [12]	-12~+12 [+6]	DRY~FX [50:50]
Mod Depth	Delay Time	Feedback		Dry : FX Balance
0~99 [75]	0~450 [120]	-99~+99 [+16]		●DRY~FX [60:40]
" [99]	" [300]	" [+30]		● " [50:50]
Dry : FX Balance	Reverb Time	Pre Delay	High Damp	Dry : FX Balance
●DRY~FX [FX]	0.2~9.9 [3.0]	0~150 [68]	0~99 [34]	●DRY~FX [70:30]
● [FX]	0.2~9.9 [1.1]	" [0]	" [28]	● " [65:35]
Dry : FX Balance	Mod Speed	Mod Depth	Mod Waveform	Dry : FX Balance
●DRY~FX [70:30]	0.03~30 [0.39]	0~99 [99]	SIN, TRI [TRI]	●DRY~FX [50:50]
Dry : FX Balance	Mod Speed	Mod Depth	Feedback	Dry : FX Balance
●DRY~FX [70:30]	0.03~30 [0.21]	0~99 [96]	-99~+99 [-75]	●DRY~FX [50:50]
Dry : FX Balance	Drive	Hot Spot	Resonance	Out Level
DRY~FX [79:21]	1~111 [105]	1~99 [99]	0~99 [07]	1~99 [10]
" [75:25]	" [65]	" [90]	" [63]	" [20]
Dry : FX Balance	Mod Speed	Mod Depth	Feedback	Dry : FX Balance
●DRY~FX [60:40]	0.03~30 [0.69]	0~99 [90]	-99~+99 [+99]	●DRY~FX [25:75]
Dry : FX Balance	Acceleration	Slow Speed	Fast Speed	Dry : FX Balance
DRY~FX [70:30]	1~15 [10]	1~99 [25]	1~99 [69]	DRY~FX [30:70]

* : Dynamic Modulation allows you to switch between "Slow speed" and "Fast speed".

Global Parameters

- Settings made in this mode are memorized even when the power is turned off. It is not necessary to write these settings into memory.

Functions In Global Mode

To select a page, use the [PAGE+] or [PAGE-] button, or enter the page number directly from the numeric keypad while holding down the [EDIT] button. To select a parameter, use the [◀], [▶] cursor buttons. To set a parameter value, use the [▲/YES] and [▼/NO] buttons, or the VALUE slider, or enter the value directly from the numeric keypad while holding down the [ENTER] button. For some parameters, you can enter the number only from the number keypad to set the value. For the Drum kit 6B and 7B Key parameters, press a desirable key on the keyboard while pressing the [ENTER] button to select the index assigned to the corresponding key.

LCD	Parameters	Description
0A	Master Tune	Overall pitch adjustment
0B	Transpose	Overall transposition
0C	Position	Position where transpose and velocity curve become effective
0D	Velocity Curve, After Touch Curve	Velocity curve and After Touch curve settings
0E	Computer Select	Sets PC I/F clock.
1A-1G	Scale Type/User Scale	Sets the scale type and the user scale
1H, 1I	Sub Scale	Sets the sub scale
2A	Global MIDI Channel	Specifies MIDI Global Channel, and filters note data
2B	Local Control	Local On/Off setting
2C	External Out Select	Selects MIDI OUT or TO HOST for data transmission.
2D, 2E	MIDI Filter	Transmission/reception switches for MIDI messages
3A, 3B	Prog.Protect, Combi. Protect	Memory protect (Program, Combination)
3C	Page Memory	Sets the page memory function
4A	MIDI Data Dump	Transmits various parameters as MIDI exclusive messages
5A	Preset Data Load	Loads preset data
6A-6D	Drum Kit 1	Assign drum sounds
7A-7D	Drum Kit 2	Assign drum sounds
8A	Copy Drum Kit	Copy Drum Kit data
9A	Assignable Pedal Setup	Sets assignable pedal function.
9B	Assignable Switch Setup	Sets assignable switch function.
9C	Polarity	Sets polarity of assignable pedal/switch.
10A	MG Wheel Select	Sets modulation wheel function
10B	Bend Wheel Calibration Set	Adjusts effect range of pitch bend wheel
10C	MG Wheel Calibration Set	Adjusts effect range of modulation wheel

Saving Global Setup Data

All global settings are stored when the X5 is powered off. You do not need to use the Write function to save them.

0A – 0E Master Tune/Transpose/Position/Velosity Curve/After Touch Curve/Computer Select

Here, you can tune the X5, and set the responses and baud rate for communication with a computer.

00A MASTERTUNE ▶ Tune+00: 440.00Hz	00B TRANPOSE ▣ Trans+00	00C POSITION ▣ AfterKBD	00D CURVE ▣ Vel=3 Aft=3	00E PC I/F CLK ◀ 31.25kBPS
---------------------------------------	----------------------------	----------------------------	----------------------------	-------------------------------

0A 0B 0C 0D 0E

LCD	Parameter	Range	Description
0A	Master Tune (Tune)	-50 ... +50	Used to tune the X5 in cent steps.
0B	Transpose (Trans)	-12 ... +12	Used to transpose the X5 in semitone steps.
0C	Position	AfterKBD BeforeTG	Data before tone generator is affected by transpose and velocity curve. Keyboard data is affected by transpose and velocity curve.
0D	Velocity curve (Vel)	1–8	Velocity response curve
	After Touch curve (Aft)	1–8	After Touch response curve
0E	Computer Select	32.25 kBPS 38.4 kBPS	Baud rate setting for communication with a computer

0A Master Tune: This function allows you to tune the X5. The selected tuning is indicated in steps and Hz. 0 cents is equal to 440Hz (A4).

The X5 can also be tuned from external MIDI devices that can output MIDI RPN Fine Tune messages (the X5 cannot output these messages). In Multi mode, these messages are received on the MIDI Channels specified for each track and control the Detune parameters. In all other modes, they are received on the Global MIDI Channel and control the Master Tune function. Refer to page 163 for MIDI RPN Fine Tune messages.

0B Transpose: This function allows you to transpose the X5. This is useful when you want to play a song in a different key. The transpose function can be placed after the keyboard or before the X5 tone generator. (see below 0C Position.)

0C Position: Determines whether or not the settings of 0B Transpose and 0D Velocity Curve in Global mode will affect the data transmitted to MIDI OUT or TO HOST, and the data received at MIDI IN or TO HOST.

After KBD: with this setting, transposition takes place after the keyboard, so only the note numbers are changed. This setting affects the keyboard data recorded by a computer, the keyboard data played by the tone generator, and the keyboard data output via MIDI OUT. MIDI IN data and playback data from a computer is not affected. Use this setting when using the X5 as a MIDI master keyboard.

The X5 outputs note numbers 36–96 when transpose is set to 0, 24–84 when transpose is set to -12, and 48–108 when transpose is set to +12.

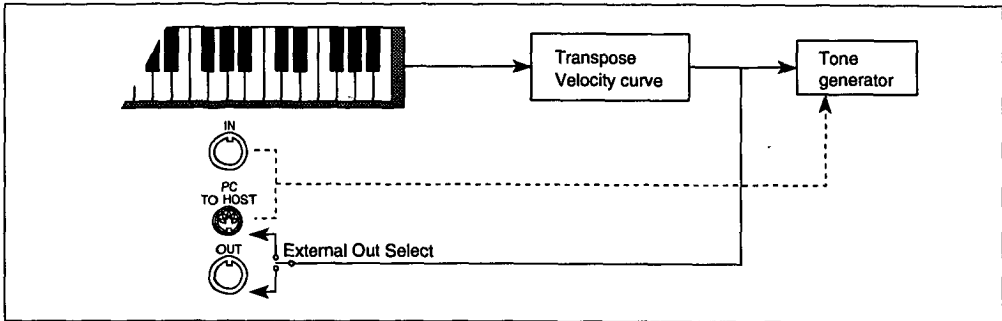

Before TG: with this setting, transposition takes place before the tone generator, so the notes you play will be affected. This setting affects the keyboard data played by the tone generator and the data received at MIDI IN/TO HOST. Keyboard data and MIDI OUT/TO HOST data is not affected. Use this setting when using the X5 as a MIDI tone generator.

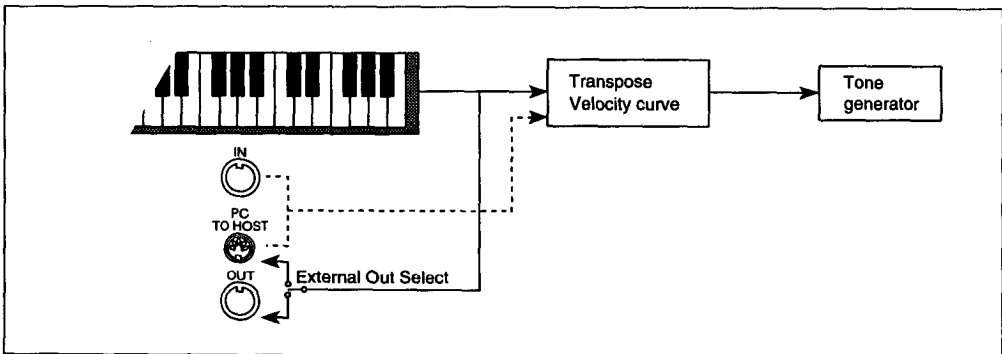

0D Velocity Curve: This parameter allows you to adjust the velocity response. A low setting requires strong playing to achieve the maximum value (insensitive). A high setting will achieve the maximum value with soft playing (sensitive). Select one of the eight curves to suit your playing style. You can select whether this function affects data after the keyboard or before the tone generator (0C Position - see page 147.) The X5 transmits both note-on and note-off messages.

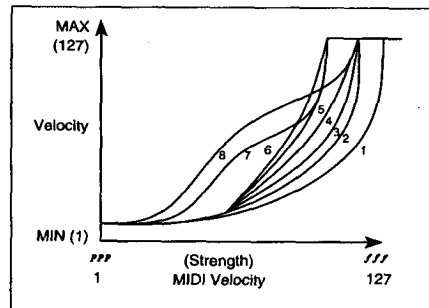

When the Position parameter is set to AfterKBD, both messages are affected.

Curves 7 and 8 are suitable when you do not need velocity, or when you wish to make the intensity of the sound even, since changes are not obvious when playing moderately. However, Curves 7 and 8 are difficult to control, because even soft playing will generate significant changes.

Vel. Curve

1. Strong playing produces an obvious effect.
2. }
3. Standard curve
4. }
5. }
6. Moderate playing produces an obvious effect.
7. Small changes and a constant effect with moderate playing
8. Similar to Curve 7, but slightly flatter.

After Touch Curve: This parameter allows you to adjust the response of After Touch applied by the X5 modulation wheel or sent from a sequencer. Select one of the eight curves.

This function affects data generated by the tone generator and data received at MIDI OUT/TO HOST. It does not affect output data.

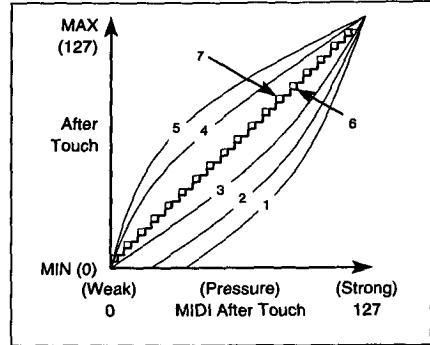

Curves 6 and 7 change in steps of 24 and 12, respectively. Curve 7 changes in steps of 12, and allows the pitch to change in semitones when pitch shift width for After Touch is set to one octave. Curve 8 is random. You can use this when you wish to achieve a special effect or give an irregular pitch shift through After Touch.

After Touch Curve

1. Strong playing produces an obvious effect.
2.
3. Standard curve
4.
5. Moderate playing produces an obvious effect.
6. A little bit coarse (24 steps)
7. More coarse (12 steps)
8. Random

0E Computer Select: This parameter allows you to set the baud rate for communication with a personal computer connected to the TO HOST connector on the rear panel.

- IBM PC compatible computers 38.4 kBPS
- Apple Macintosh series computers 31.25 kBPS

1A – 1I Keyboard Scale

This function allows you to select scales. You can also create your own scale.

01A SCALE TYPE ▾ User Scale	01B SCALE KEY ▾ Key=C	01C User Scale ▾ C+00 C#+00 D+00	01D User Scale ▾ D#+00 E+00 F+00	01E User Scale ▾ F#+00 G+00 G#+00
1A	1B	1C	1D	1E
01F User Scale ▾ A+00 A#+00 B+00	01G Copy SCALE ▾ Slendro OK?	01H SUB SCALE ▾ Equal Temp	01I SUB KEY ▾ Key=C	
1F	1G	1H	1I	

LCD	Parameter	Range	Description	
1A	Scale Type	Equal Temperament	Most commonly used equal temperament scale. Songs can easily be transposed into different keys.	
		Equal Temperament2	Like equal temperament, but with slight random pitch variations between subsequent key presses. This is useful for simulating the unstable pitch of an acoustic instrument.	
		Pure Major	Intervals such as third and fifth are perfectly in tune. Other intervals will correspondingly be out of tune, so you must specify a key. See LCD screen 1B.	
		Pure Minor	Like the pure major scale, but minor.	
		Arabic (quarter tone scales often used in Arabic music)	Scale	Key
			RAST DO / BAYATI RE	C
			RAST FA / BAYATI SOL	F
			RAST SOL / BAYATI LA	G
			RAST RE / BAYATI MI	D
			RAST SI ♭ / BAYATI DO	A ♯ (B ♭)
		Pythagorean	Ancient Greek tuning, useful when playing melodies	
		Werkmeister	Equal temperament style that was used in the latter part of the baroque period.	
		Kimberger	Developed in the 18th Century, used mainly for harpsichord.	
Slendro	Indonesian gamelan tuning with 5 notes per octave. When key is set to C, notes C, D, F, G, A are used. Other notes are set to equal temperament.			
Pelog	Like the slendro scale, but with 7 notes per octave. When key is set to C, notes C, D, E, F, G, A, B are used.			
User Scale	This allows you to create your own tuning, and is set up using LCD screens 1C to 1F.			
1B	Scale Key	C-B	Specifies the tonic (key note) of the scale.	
1C	User Scale	-99...+99	Used to tune the individual notes for the user scale in 1 cent steps	
				C C# D
1D				D# E F
1E				F# G G#
1F	A A# B			
1G	Copy Scale	Same as 1A (except User scale)	Copy a preset scale to the user scale (key not copied)	
	OK to Copy	OK?	Executes scale copy	
1H	Sub Scale Type	Same as 1A	See 1A descriptions	
1I	Sub Scale Key (Key)	C-B	Specifies the tonic (key note) of the sub scale	

1A Scale Type: as well as the usual equal temperament scale, 11 other scales including a user definable scale are available.

1B,1I Scale Key: In this case, specify a Scale key (C-B) except Equal Temperament.

When Arabic is used and the Scale Key is "C," the notes E and B are lowered by 52 cents (RAST DO/BAYATI RE). Changing the Scale Key allows you to select other scales. The following table shows the scales and keys frequently used in Arabic music.

Scale	Key
RAST DO/BAYATI RE	C
RAST FA/BAYATI SOL	F
RAST SOL/BAYATI LA	G
RAST RE/BAYATI MI	D
RAST SI \flat /BAYATI DO	A# (B \flat)

Note: The 1B Key and 1I Sub Scale Key parameters are affected by the OB Transpose function, when the transpose position is set to AfterKBD. They are not affected when it is set to BeforeTG.

1C-1F User Scale: this scale allows you to define your own personal tuning scale. The tuning of each keyboard note can be adjusted ± 99 cents on LCD screens 1C to 1F. To edit one of the preset scales, first copy it (1G), then edit it as a user scale.

The User Scale settings are used by both the main and the sub.

1G Copy Scale: This is used to create your own scale based on one of the preset scales. The scale selected here is copied to the user scale to enable you to edit it using pages 1C-1F.

1H Sub Scale: it is possible to switch between two scales, main and sub, using a pedal switch.

- 1) Connect an optional Korg PS-1 or PS-2 pedal switch to the ASSIGNABLE SWITCH connector.
- 2) In Global mode, assign the pedal to Scale Switching. See "9A-9C Assignable Pedal/Switch & Polarity Setup" on page 161.

When the pedal is pressed, the Sub Scale is selected and MIDI message [Bn, 04, 7F] is output. When the main scale is selected, the message [Bn, 04, 00] is output.

If MIDI message [Bn, 04, 00-3F] (Controller #04 is set to 0-63) is received, the main scale is selected. If the MIDI message [Bn, 04, 40-7F] (controller #04 is set to 64-127) is received, the sub scale is selected. In Combination mode, scales can be selected by any Timbre. In Multi mode, by any Track. So, for example, you could have one Timbre playing the melody with Arabic scale, and another Timbre playing the backing with an Equal Temperament scale.

- User scale settings are shared by the main scale and sub scale.

2A – 2E Global MIDI Channel, Note Receive Filter, Local Control, External Out Select & MIDI Filter

These parameters allow you to set the Global MIDI Channel, note numbers, local on/off, MIDI data transmission destination, and MIDI filter.

02A MIDI GLOBAL CH=1 NOTE R:ALL	02B MIDI GLOBAL LOCAL:ON	02C EXT OUT SEL MIDI	02D MIDI FILTER PRG:ENA AFT:ENA	02E MIDI FILTER CTRL:ENA EX:ENA
2A	2B	2C	2D	2E

LCD	Parameter	Range	Description
2A	Global MIDI Channel (CH)	1-16	Sets the Global MIDI Channel.
	Note Receive Filter (Note R)	EVEN ODD ALL	Responds to even notes only. Responds to odd notes only. Responds to all notes.
2B	Local Control	OFF ON	X5 keyboard and wheel controls of tone generator Off X5 keyboard and wheel controls of tone generator On
2C	External Out Select	MIDI PCIF	X5 keyboard and wheel control data is output via MIDI OUT X5 keyboard and wheel control data is output via TO HOST
2D	Program Change Filter (PRG)	DIS ENA PRG NUM	Program Change operation disabled Program Change messages select Combinations and Programs Program Change messages select only Programs (not Combinations) MIDI Bank Select messages are not sent or received; only Program Change messages are received and sent.
	After Touch Filter (AFT)	DIS ENA	After Touch send/receive disabled After Touch send/receive enabled
2E	MIDI Controller Filter (CTRL)	DIS ENA	MIDI Controller send/receive disabled MIDI Controllers send/receive
	System Exclusive Filter (EX)	DIS ENA	System Exclusive operation disabled System Exclusive data sent and received

2A Global MIDI Channel: the Global MIDI Channel is used as follows: to receive MIDI data in Program mode, to select Combinations in Combination mode (when MIDI Filter PRG is set to ENA or NUM), to control effects, and to send System exclusive messages.

All MIDI data on the X5 is transmitted on the Global MIDI Channel.

MIDI data for individual Timbres in a Combination and tracks in a song is received on the MIDI Channels specified in Combination Edit mode (Timbres) and Multi mode (tracks), respectively.

In Combination mode, when a Program Change message is received on the Global MIDI Channel, a Combination is selected. So, to play a Combination from an external MIDI device, set the Global MIDI Channel and the Timbre MIDI Channels differently.

When you play a Combination using the X5 keyboard, set them the same.

MIDI data on the Global MIDI channel is used to control the effects (ON/OFF and Dynamic Modulation).

Note Receive Filter: normally, this should be set to ALL. However, if you want to increase the number of available notes by using another X5 or tone generator simultaneously, feed data to both tone generators, and set one to ODD only odd-number notes will sound and the other to EVEN (only even-number notes will sound).

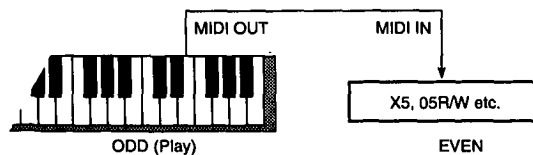

2B Local Control: when set to OFF, the X5 keyboard and wheels do not control the X5 tone generator. However, MIDI data generated by the keyboard and wheels is still sent via MIDI or TO HOST.

Normally, this parameter should be set to ON. However, to prevent a MIDI data loop when using the X5 with, for example, an external sequencer, set this to OFF. In this case, MIDI data from the X5 keyboard is sent to the sequencer via the MIDI OUT, and if the sequencer's MIDI thru or echo function is turned on, returned back to the X5 via MIDI IN.

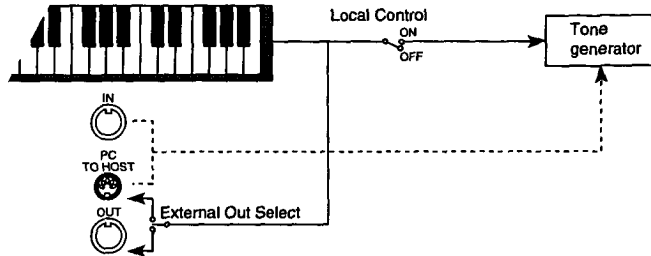

2C External Out Select: This parameter determines if the X5 keyboard and wheel control data is transmitted from MIDI OUT or TO HOST connector.

Select "MIDI" to play an external MIDI device with its MIDI IN connected to the MIDI OUT connector on the X5. Select "PCIF" to output data to a computer connected to the TO HOST connector on the X5.

The X5 receives data input at MIDI IN or TO HOST regardless of this parameter setting.

2D Program Change Filter:

When DIS is selected, MIDI Program Change messages are neither sent nor received.

When ENA is selected, MIDI Program Change messages received on the Global MIDI Channel select Programs in Program mode, and Combinations in Combination mode. MIDI Bank Select messages select banks in the selected mode. In Combination mode, MIDI Program Change messages received on other channels select Programs for corresponding Timbres. If the Global MIDI Channel and a Timbre's MIDI Channel are set the same, the Global MIDI Channel has priority. So a Combination is selected, and the Timbre's Program remains the same. In Multi mode, MIDI Program Change messages select Programs on tracks set to the corresponding MIDI Channel. If you select a new Program or Combination on the X5, it will transmit the Program Change and Bank Select messages.

When PRG is selected, MIDI Program Change messages received on the Global MIDI Channel select Programs in Program mode, but in Combination mode they select Timbre Programs. MIDI Bank Select messages select banks in the selected mode.

When NUM is selected, operation is basically the same as for ENA except that MIDI Bank Select messages are ignored. (With ENA or PRG setting, the Bank Select messages will be received/transmitted.)

The following table shows the Program Change and Bank Select receive conditions.

Mode		DIS	ENA	PRG	NUM
Program Play	Program No.	X	O	O	Δ
Combination Play	Combination No.	X	Δ	X	Δ
Combination Play	Timbre Program No.	X	O	O	Δ
Sequencer Play	Track Program No.	X	O	O	Δ

- X — Not received
- Δ — Program Change received only
- O — Program Change and Bank Select received

After Touch Filter: When this is set to DIS, After Touch messages are neither sent nor received. The X5 uses Channel After Touch only, not Polyphonic After Touch. This setting does not affect the function of the X5 controller onto the X5 tone generator.

2E MIDI Controller filter: When the MIDI Controller filter is set to DIS, MIDI Controller messages such as Pitch Bend, Pitch modulation, and Volume are neither sent nor received by the X5. This setting does not affect the function of the X5 controller onto the X5 tone generator.

MIDI System Exclusive Filter: When the MIDI System Exclusive Filter is set to DIS, System Exclusive data for parameter editing is neither sent nor received by the X5. Normally, this should be set to DIS, however, when using an X5 editing program on a personal computer, set it to ENA.

By connecting the MIDI OUT of one X5 to the MIDI IN of another X5, and setting both System Exclusive filters to ENA, both X5s can be edited simultaneously.

If 4A MIDI DUMP (see page 155) is selected and shown on the screen, the X5 sends and receives MIDI Dump data through MIDI System Exclusive messages even with this parameter set to "DIS."

3A – 3C Program/Combination Memory Protect & Page Memory

The Memory Protect functions allow you to protect Programs and Combinations, and the Page Memory function remembers the current LCD screen when you exit a mode.

03A PROTECT PROGRAM:OFF	03B PROTECT COMBINATION:OFF	03C PAGE MEMORY OFF
3A	3B	3C

LCD	Parameter	Range	Description
3A	Program Protect (PROGRAM)	OFF ON	Program memory is not protected. Program memory is protected.
3B	Combination Protect (COMBINATION)	OFF ON	Combination memory is not protected. Combination memory is protected.
3C	Page Memory	OFF ON	Page Memory function off Page Memory function on

3A Program Memory Protect: When this parameter is set to on, you cannot write Programs to Bank A. Set this OFF before you write the edited data, before you load the preset data, or before the X5 receives MIDI Dump data.

3B Combination Memory Protect: When this parameter is set to on, you cannot write Combinations on the X5. Set this OFF before you write the edited data, before you load the preset data, or before the X5 receives MIDI Dump data.

3C Page Memory: The Page Memory function remembers the current LCD screen when you exit a mode. The next time you enter that particular mode, the same LCD screen is selected automatically.

In Multi mode, however, this function will not take you to the following parameter pages: Damper Pedal Filter, After Touch Filter, Control Change Filter, Key Window Bottom, and Velocity Window Bottom. Instead, a parameter page preceding these pages will be selected.

4A MIDI Data Dump

This page allows you to transmit X5 data via Exclusive data to an external MIDI device, such as a MIDI data filer, computer, Korg 05R/W, X5DR, or another X5.

When screen 4A is selected, MIDI Dump data can be sent and received even when the MIDI System Exclusive filter on 2E MIDI Filter is set to DIS.

```
04A MIDI DUMP
PROG →MIDI OK?
```

4A

LCD	Parameter	Range	Description
4A	Dump Data	PROG COMBI MULTI GLOBAL D.KIT ALL	Dump 100 Programs in bank A Dump 100 Combinations Dump Multi setup data Dump Global setup data(0A-1I) Dump 2 drum kits Dump all the above data
	External Out Dump Select	MIDI PCIF	Exclusive data is transmitted from MIDI OUT. Exclusive data is transmitted from TO HOST.
	OK to Data Dump	OK?	Executes Data Dump

Saving Data with MIDI Data Dump

- 1) To save X5 data using MIDI Data Dump, you must connect a MIDI device capable of receiving MIDI Data Dump to the X5 MIDI OUT, or connect a computer's serial port to the X5's TO HOST. If you are saving the data to a MIDI data filer, you do not need to set the MIDI Channels. However, if you are transferring the data to an X5, X5DR, or 05R/W, the Global MIDI Channel on both devices should be set the same.
- 2) Specify the X5 data that you want to save.
- 3) "External Out Dump Select" on this page determines whether data is transmitted through MIDI OUT or through TO HOST. Set this to MIDI for transmission through MIDI OUT, and set it to PCIF through TO HOST. In this case, the setting of 2C External Out Select does not affect data transmission.
- 4) Position the cursor on OK?, then press the [▲/YES] button to dump

When transmission is completed, "Completed" appears on the screen. Press the [▲/YES] or [▼/NO] button to return to the previous screen.

Note: While dumping, do not press any buttons.

The following table lists the data size and dump time for each Data Dump.

Type of Data Dump	Approx. Data Size	Approx. Dump Time (Seconds)
Program	18.7KByte	6.0
Combination	15.5KByte	5.0
Global setup	39Byte	0.1
Drum kit	1.0KByte	0.3
Multi	0.3KByte	0.1
All data	35.5KByte	11.4

If Multi or All data is selected for data dump, each data dump operation transmits dump data, followed by "Multi Setup Data (exp)," and two types of data is sent to the data filer.

You need to send these two types of data to set the parameters in Multi mode.

If Multi or ALL data is selected for data dump, only the effect settings in Multi mode data are sent. For MULTI SETUP DATA (exp), Multi mode track setup data (excluding the effect data) is sent.

When you switch from Program Play mode to Program Edit mode while 2E MIDI System Exclusive is set to ENA, the parameters of the Program selected in Program Play mode are transmitted. If you select a Combination in Combination Play mode, the parameters of that Combination are transmitted.

Loading Data with MIDI Data Dump

- 1) To load the MIDI data back into the X5, connect the external MIDI device to the X5 MIDI IN or a computer's serial port to the X5's TO HOST, and make sure that the external devices MIDI Channel matches the X5 Global MIDI Channel.
- 2) If you are loading Program or Combination data, make sure that the respective memory protect function is set to off. See "3A – 3C Program/Combination Memory Protect & Page Memory" on page 154.
- 3) To transfer data from the external MIDI device, make sure that the channel on the transmit device is set to the Global MIDI Channel (If you send data saved in the data filer, set the Global MIDI Channel to the Global MIDI Channel on the transmit device that was selected when you saved the data.). See "MIDI Data Format" on page 169 for the data dump format.

Dump data is compatible between the X5DR, X5, and 05R/W although the following parameters are incompatible: Global mode parameters for the X5 keyboard (Position, Local Control), Damper Pedal Polarity, Pedal Assign are not applicable on the X5DR or 05R/W. All the parameters in Multi mode except for the effect settings are incompatible with the 05R/W.

When you send any of Programs that use Multisounds 340–429, and Drum Kits that use drum sounds 164–214 from the X5DR to the X5 or 05R/W, they are not assigned to Programs, or Drum Kits on the X5 or 05R/W. Therefore, no sound is produced. The same thing applies to the X5D.

Note: Do not touch any switches on the X5 during the data dump operation. If you wish to transmit multiple MIDI dump data files to the X5, send them one at a time. Do not try to send them all at once.

5A Preset Data Load

This function loads all factory preset data (Combinations, Programs, Drum kits, Multi setup data, Global data) into the internal memory.

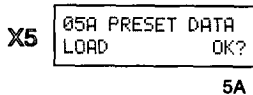

LCD	Parameter	Range	Description
5A	Preset Data Load		Loads preset data (Program, Combination, Drum kit, Multi setup data, Global data).
	OK to Load	OK?	Executes the load operation.

The following data is loaded.

- 100 Programs: Programs listed on the Preset Program Name list (Bank A)
- 100 Combinations: Combinations listed on the Preset Combination Name list
- 2 Drum kits: Drum kits listed on the Preset Drum Kit 1&2 list
- Multi setup: Default settings obtained when the power is turned on
- Global data:

Master tune0	Global MIDI Channel 1
Transpose 0	Note Receive ALL
Position AfterKBD	Local Control ON
Velocity Curve 3	External Out Select. MIDI
After Touch Curve 3	MIDI Filter PRG:NUM, EX:DIS, others:ENA
Scale Type Equal Temp	Assignable Pedal Assign. OFF
Scale Key C	Assignable Switch Assign Damper
User Scale E and B are -52, others are all 0.	Assignable Switch Polarity. -
Sub Scale Type. User Scale	Modulation Wheel JoyUp (Controller#1)
Sub Scale Key C	

- Global Channel and MIDI Filter are also initialized. PC I/F CLK and Page Memory settings are not initialized.

Note: Data cannot be loaded when the memory protect is set to ON. Use pages 3A and 3B to cancel the memory protect.

X5D

05A PRESET DATA
ALL PRE-b OK?

5A

LCD	Parameter	Range	Description
5A	Preset Data Load Source	ALL Combination (CMB) Program (PRG) Drum Kit (KIT)	Select a preset data source to load. Loads all data of Preset a or b, Multi data, and Global data. Loads one Combination of Preset a or b. Loads one Program of Preset a or b. Loads one Drum Kit of Preset a or b.
	Source ALL	PRE-a, PRE-b	(When ALL is selected:) Loads either Preset a or b, Multi Setup data, and Global data.
	Source PRG/CMB	a, b	(When CMB or PRG is selected:) Selects Preset a or b as a source.
	Source No. PRG/CMB	00–99	(When CMB or PRG is selected:) Selects a source Program/Combination number.
	Destination No. PRG/CMB	00–99	(When CMB or PRG is selected:) Selects a destination Program/Combination number.
	Source KIT	a, b	(When KIT is selected:) Selects Preset a or b as a source.
	Source No. KIT	K1, K2	(When KIT is selected:) Selects a source Drum Kit number.
	Destination No. KIT	K1, K2	(When KIT is selected:) Selects a destination Drum Kit number.
	OK to Load	OK?	Executes the Preset Data Load operation.

The following data can be loaded:

Preset a:

100 Programs of Preset a
100 Combinations of Preset a
Drum Kits 1, 2 of Preset a

Preset b (Same as the sound data of X5 and 05R/W):

100 Programs of Preset b
100 Combinations of Preset b
Drum Kits 1, 2 of Preset b

Multi Setup data:

Default settings when the power is turned on (see page 114)

Source ALL : This allows all the data in PRE-a or PRE-b, Multi Setup data, and Global data to be loaded.

Source CMB : This allows one of 100 Combinations of Preset a or b to be loaded into a specified Combination number in the internal memory.

Source PRG : This allows one of 100 Programs of Preset a or b to be loaded into a specified Program number in the internal memory.

Source KIT : This allows one of Drum Kits 1 and 2 of Preset a or b to be loaded to Drum Kit 1 or 2 in the internal memory.

- When you load data using Source CMB, Source PRG, or Source KIT, the X5DR may produce Program sound that is different from the sound of Programs loaded using Source ALL.
- This happens when the same Preset a or b data is not used for the Combination and its Timbre's Programs (and the Drum Kit if a Drum Program is being used), or when the load destination Program number does not match the Timbre's number used by the Timbre.

6A–6D Drum Kit1 Setup

These parameters allow you to set up Drum kit1.

Before editing a drum kit, you must select a Program in Program Play mode that is using that drum kit (that is, a Program whose oscillator mode is set to DRUMS). Drum Kits are affected by the VDF, VDA, and effect settings like Multisounds in a Program. They use the parameter settings of the Program selected in Program Play mode.

After editing a drum kit, select a Drum Kit in Program Edit mode Page 1A, and write the edit to the number of the Program to be used on page 16A.

Internal RAM has two Drum kits. You cannot edit the Drum kits in the ROM. To edit them, first copy them into RAM. (see “8A Drum Kit Copy” on page 160)

06A DRUM1 #01 105:Guiro S	06B KEY/TUNE/L D#4 T+019 L+65	06C DECAY/ASGN Dc#+00 A#gn+EX1	06D PAN/SEND Pan=CNT C=0 D=0
6A	6B	6C	6D

LCD	Parameter	Range	Description
6A	Index (#)	0–59	Select an index
	Drum Sound	---, 000–214 (XSD) ---, 000–163 (XS)	Select a drum sound for an index
6B	Key	C0–G8	Select a key (note) for an index
	Tune (T)	–120...+120	Tune an index (1 = 10 cents)
	Level (L)	–99...+99	Set the index volume level
6C	Decay (Dcy)	–99...+99	Set the index decay
	Group Assign (Asgn)	---, EX1...EX6, SLF	Assign an index to an exclusive group
6D	Pan (Pan)	OFF, A15–CNT–B15	Output pan to buses A and B
	Send C (C)	0–9	Output level to bus C
	Send D (D)	0–9	Output level to bus D

6A Index: X5 drum kits consist of indexes. Think of an index as an empty drum case, into which you put a drum sound, select a keyboard note, set a volume level, and pan. Parameters 6A to 6D affect the selected index.

As well as using the VALUE slider and the [▲/YES] and [▼/NO] buttons to select indexes, you can also use the X5 keyboard. Position the cursor on the index parameter, press and hold down the [ENTER] button, then press a key. The index assigned to that key is selected.

Indexes that have not been assigned a drum sound display the message “No Assign” when selected.

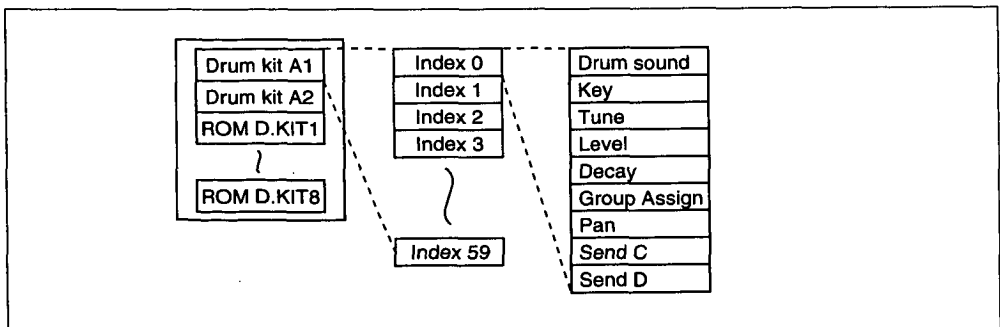

Drum Sound: this parameter allows you to select a drum sound for the currently selected index. A setting of --- means that no drum sound is selected. See “Voice Name List” for available drum sounds.

- 6B Key:** this parameter allows you to select the note that will trigger the index. It is not possible to select the same key for two indexes. So, if you want to select a key that is being used by another index, set the other index to a different key first.

As well as using the VALUE slider and the [▲/YES] and [▼/NO] buttons to select keys, you can also use a MIDI keyboard. Select the Key parameter, press and hold down the [ENTER] button, then press a key.

If a key is selected for an index, but no drum sound is assigned to that index, the drum sound assigned to the next key up plays when that key is pressed. The pitch of the drum sound is lowered one semitone. This can be corrected using the Tune parameter.

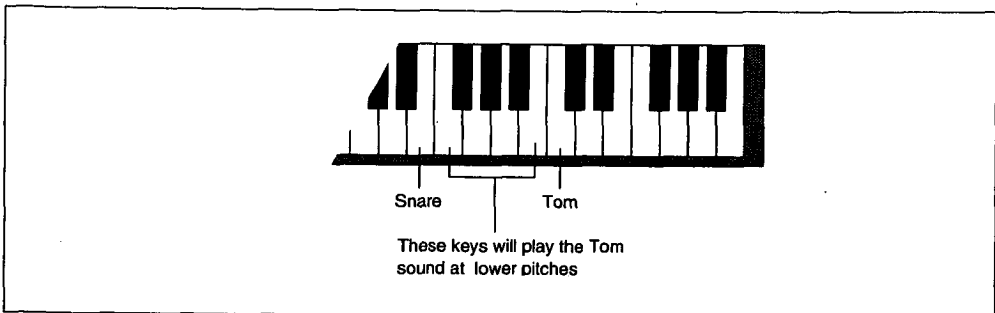

Tune: this parameter allows you to tune individual indexes ± 120 (10 = 1 semitone, 120 = 1 octave). For example, you may use the same snare drum sound for two indexes, but tune them differently. Use this parameter to make hi, mid, and low tom-toms from one tom drum sound.

Level: this parameter allows you to set the level of individual indexes. You can use this parameter to set up your drum mix. The overall volume level is determined by the current Program's Oscillator Level parameter.

- 6C Decay:** this parameter allows you to set the decay time of individual indexes. This parameter works in conjunction with the Program's VDA EG Decay Time parameter. So, depending on that parameter setting, you may find that increasing or decreasing this value has little or no affect.

Group Assign: this parameter determines how an index is played in relation to other indexes. In an exclusive group (EX1 to EX6), only one index can play at a time (monophonic). If, while an index is playing, another index in that group is triggered, the first index stops and the new index plays. This is useful for creating realistic hi-hats. By assigning an open hi-hat and a closed hi-hat to the same exclusive group, the sound of the open hi-hat can be cut short by triggering the closed hi-hat. Just like pressing a real hi-hat pedal.

When SLF is selected, the index will be monophonic. In other words, while a long drum sound such as a crash cymbal is playing, if it is re-triggered, the original cymbal sound is cut short, and the drum sound plays again from the beginning.

- 6D Pan:** this parameter is used to pan the index between buses A and B. These buses feed the effects processors. See "20A–20B Effect Placement" on page 115.

When OFF is selected, no signal is sent on buses A and B. The CNT setting means center: signals of equal level are fed buses A and B. This parameter can be used to simulate the stereo spread of a real drum kit with, for example, tom toms panned between the stereo outputs.

Note: The Program's Pan parameter is ignored when its Oscillator mode is set to DRUMS. In this case, the drum kit Pan parameter specified on LCD screen 6D is used.

Send C, Send D: these parameters are used to set the level of the index sent to buses C and D. These buses feed the effects processors. See "20A–20B Effect Placement" on page 115.

Pan and Send functions are slightly different between Program Play mode and Combination Play mode or Multi mode as follows:

Program mode: The panpot setting in Global mode is used. (You cannot set the panpot in Program Edit mode.) The send value set in Program Edit mode is applied to the send value for each index in Global mode before outputs C and D. That is, the balance of the send level between indexes is not changed, but the entire send level is changed. You can edit the send value in Program Edit mode using MIDI Controllers 91 and 93.

Combination/Multi mode: With a setting of “PRG (Program)”, the panpot setting in Global mode is used (like in Program Play mode). With other settings, the value of all the indexes are summarized.

With a setting of “P”, the send function in Program Play mode is applied here. With another setting, the value of all indexes is summarized.

In general, you should set the panpot to “PRG” and send to “P.” You can edit the panpot setting using MIDI Controllers 91 and 93 when “PRG” or “OFF” is not selected. (The value changes in Combination Edit mode and Multi mode.) You can also edit the send setting via MIDI. In this case, with a setting of “P”, the send function in Program Play mode is added here. (The send balance between indexes remains the same.) With a different setting, the values of all the indexes are summarized.

7A–7D Drum Kit2 Setup

These parameters allow you to set up Drum kit2. Operation is the same as for “6A–6D Drum Kit1 Setup” on page 158.

07A DRUM2 #01▶ 152:Timpani	07B KEY/TUNE/L # D#4 T+019 L+65	07C DECAY/ASGN # Dcy+00 Asgn+EX1	07D PAN/SEND # Pan=CNT C=0 D=0
7A	7B	7C	7D

8A Drum Kit Copy

This function allows you to copy a drum kit to an internal drum kit.

08A COPY D.KIT A1 → A2 OK?
8A

LCD	Parameter	Range	Description
8A	Source Drum Kit	A1, A2, ROM 1–8	Select the source drum kit
	Destination Drum Kit	A1, A2	Select the destination drum kit
	OK to Copy	OK?	Executes the copy

To copy a drum kit, select the source and destination, position the cursor on OK?, then press the [▲/YES] button. The message “Are You Sure OK?” will appear. (A1: Drum Kit1, A2: Drum Kit2) Press the [▲/YES] button to copy, or the [▼/NO] button to cancel.

Note: The drum kit at the specified destination is overwritten when this function is executed. So be careful that you don't overwrite (lose) a valuable drum kit.

9A–9C Assignable Pedal/Switch & Polarity Setup

These parameters assign a function to the Assignable Pedal/Switch, and set the damper pedal polarity.

09A ASSIGN PDL OFF	09B ASSIGN SW Damper	09C POLARITY -
9A	9B	9C

LCD	Parameter	Range	Pedal	Description
9A	Pedal Setup (ASSIGN PDL)	OFF	F.C	No function
		Volume		Control the X5 volume. When pressed, the corresponding MIDI Volume messages are output. (Controller #7)
		Expression		Operates the same as volume. Although, a different MIDI message is output. (Controller #11)
		VDF cutoff		Control the VDF Cutoff Frequency parameter. Pressing the foot controller increases the Cutoff Frequency. Transmits MIDI brightness.
		Effect control		Control effect dynamic modulation. When pressed, MIDI Effect Control messages are output. (Controller #12) See "16A–16C Effect1 Setup" on page 114.
		Data entry		Adjusts the selected parameter in Program Edit mode and Combination Edit mode, just like using the VALUE slider.
9B	Switch Setup (ASSIGN SW)	Damper	F.S	Damper (sustain); Sound is sustained after you release the key. (Control Change #64)
		Program Up		Increment Programs in Program/Combination mode and Combinations in Combination mode. When pressed, a corresponding MIDI Program Change message is output.
		Program Down		Decrement Programs in Program/Combination mode and Combinations in Combination mode. When pressed, a corresponding MIDI Program Change message is output.
		Effect 1 on/off		Switch Effect 1 on and off. When pressed, the corresponding MIDI Effect 1 on or off message is output. (Controller #92)
		Effect 2 on/off		Switch Effect 2 on and off. When pressed, the corresponding MIDI Effect 2 on or off message is output. (Controller #94)
		Scale Switch		Switch between the main and sub scales. Controller #4 is output. See "1A – 11 Keyboard Scale" on page 150.
9C	Polarity	+ -		Positive polarity foot pedal Negative polarity foot pedal

The Pedal column indicates the type of pedal needed for each function.

For F.S, use an on/off type footswitch such as the Korg PS-1 or PS-2 foot pedals. For F.C, use a continuous foot controller such as the Korg EXP-2 or XVP-10.

- When no assignable pedal is used, select OFF or Volume. Otherwise, Program settings may be changed when a pedal is removed.

If you are using a Korg PS-1 foot pedal, set this to (–) negative polarity. Be aware that some pedals require a (+) positive polarity setting.

10A – 10C MG Wheel Select, MG Wheel Calibration Set & Pitch Bend Wheel Calibration Set

These parameters allow you to set the modulation wheel function, and calibrate the modulation wheel and pitch bend wheel range.

10A MG WHEEL JoyUp (MIDI Ct11)	10B BEND CALIB L*****H OK?	10C MG CALIB L*****H OK?
10A	10B	10C

LCD	Parameter	Range	Description
10A	MG Wheel Select	JoyUp (MIDI Ct11) JoyDw (MIDI Ct2) After Touch Ctl Chg Out #000-#127	Vibrato effect Wah effect After Touch effect Transmission of Contrllers
10B	Bend Wheel Calibration	*	Calibration of the pitch bend wheel range
	OK to Calibration	OK?	Executes the calibration operation.
10C	MG Wheel Calibration	*	Calibration of the modulation wheel range
	OK to Calibration	OK?	Executes the calibration operation.

10A MG Wheel Select: This parameter allows you to select the type of effect you wish to apply using the modulation wheel. Setting this to “JoyUp” applies vibrato effect to the sound via the modulation wheel, and the Modulation 1, Depth [Bn, 01, vv] (Controller #01) message is output. Setting this to “JoyDw” applies wah effect to the sound via the wheel, and the Modulation 2, Depth [Bn, 02, vv] (Controller #02) message is output. Selecting “After Touch” applies After Touch effect via the wheel (refer to “12A–12E Pitch1 Modulation” on page 86, “13A–13E Pitch2 Modulation” on page 88, and “15A–15D After Touch & Joystick Control” on page 90), and the Channel After Touch message [Dn, vv] (vv is a value) is transmitted at the same time. When Ctl Chg Out #000- #127 is selected, the corresponding Controller will be transmitted. The sound produced on the unit is not affected.

You can also control the effects via Dynamic Modulation when JoyUp, JoyDw, or After Touch is selected. (Refer to “16C Dynamic Modulation Control Source” on page 114.)

10B Pitch Bend Wheel Calibration Set: You may want to calibrate the pitch bend wheel if the pitch bend wheel does not cover the specified range when it is moved all the way forward or backward, or if the highest or lowest pitch specified is reached when you move the wheel part way. After calibration, the maximum or minimum value of the pitch bend range will be achieved when you move the wheel all the way forward or backward.

- 1) Select page 10B BEND CALIB.
- 2) Move the pitch bend wheel all the way forward or backward. The LCD screen shows “*****”
- 3) Press the [▲/YES] button.
- 4) The screen shows “Are You Sure OK?”. Press the [▲/YES] button if the setting is acceptable and you wish to execute the calibration operation. Press the [▼/NO] button to cancel the operation.

When the operation is complete, the screen shows “Completed.” If the setting is incorrect, the screen shows “Invalid Data.” In this case, repeat the procedure from Step 2.

10C MG Wheel Calibration Set: This allows you to adjust the effective range of the modulation wheel in the same manner as 10B.

Select page 10C MG CALIB, and follow the procedure for 10B from Step 2 using the modulation wheel.

Appendix

Controller Event Edit Notes

The following table shows which Controllers the X5 supports.

Controller No.	Controller	Value	Notes
0	Bank Select (MSB)	0-127	MSB of MIDI Bank Select message
1	Pitch Modulation	0-127	Move the pitch modulation wheel up
2	VDF Cutoff Modulation	0-127	Move the VDF modulation wheel up
4	Foot Controller	0-63 (Main) 64-127 (Sub)	Select scale (main, sub)
6	Data Entry	0-127	For RPN Edit (MSB) *Note 3
7	Volume	0-127	Volume *Note 2
10	Panpot	0-127	AB pan (see "MIDI Panpot, Send Data" on page 165.)
11	Expression	0-127	Same as volume *Note 2
12	Effect Control 1	0-127	Effect dynamic modulation 1
13	Effect Control 2	0-127	Effect dynamic modulation 2
32	Bank Select (LSB)	0-127	LSB of MIDI Bank Select message *Note 1
38	Data Entry (LSB)	0-127	For RPN Edit (LSB) *Note3
64	Damper Switch	0-63 (off) 64-127 (on)	Damper on/off
72	Release Time	0-127	VDF and VDA EG release time *Note 4
73	Attack Time	0-127	VDA EG attack time *Note 4
74	Brightness	0-127	VDF Cutoff *Note 5
91	Reverb Level	0-127	Send C Level (see "MIDI Panpot, Send Data" on page 165)
92	Effect1 on/off	0 (off) 1-127 (on)	Effect 1 on/off
93	Chorus Level	0-127	Send D Level (see "MIDI Panpot, Send Data" on page 165)
94	Effect2 on/off	0 (off) 1-127 (on)	Effect 2 on/off
96	Data Increment	00	RPN data increment *Note 3
97	Data Decrement	00	RPN data decrement *Note 3
100	RPN (LSB)	00 01 02	Pitch Bend Sensitivity Fine Tune Coarse Tune
101	RPN (MSB)	00	Registered parameter No. (MSB) *Note 3

Controllers 12, 13, 92, 94 (Effect Control 1 and 2, and Effect 1 and 2 On/Off) are received only on the Global MIDI Channel

Note 1: Usually, Bank Select is set as part of a Program Change event. However, if you wish to select more than 128 Programs, specify the MSB (first pair of digits) using Controller 0 and specify the LSB (second pair of digits) using Controller 32. This allows you to select a Bank from 16385 Program Banks. Receiving the Program Change messages following these Bank Select messages will switch the Programs. When the PRG filter in Global mode is set to "ENA" or "PRG," you can select Programs as follows:

- You can select any Program in Bank A.
- You can select any Program in Bank G01-128.
- You can select any drum sound in Bank G129-136.
- Any Channel can be set to not produce sound.

	MIDI IN			Bank No.	X5 Program	Examples(Hex) of MIDI
	Bank select		Program Change			
	MSB	LSB				
(1)	0	0	0~99	1	Bank A Program 00~99	Bn 00 00 20 00 Cn pp
(2)	56.57	xx	00~127	7169~7424	Bank G Program 01~128	Bn 00 38 20 00 Cn pp
(3)	62	xx	00~15,56~83,72~127	7937~8064	Bank G Program 129	Bn 00 3E 20 00 Cn pp
			16~23		Bank G Program 130	
			25		Bank G Program 131	
			32~39		Bank G Program 132	
			40~47		Bank G Program 133	
			64~71		Bank G Program 134	
			24,28~31		Bank G Program 135	
			48~55		Bank G Program 136	
(4)	58~61	xx	xx	7425~7936	OFF	Bn 00 3F 20 7F Cn 7F
	63	xx	xx	8065~8192		

xx : Any number

When you use an external MIDI sequencer, send MSB for Controller 0 and LSB for Controller 32 (see the table), then send the Program Change messages. Parameter response varies depending on the setting of the PRG filter.

When the setting is "OFF", the X5 responds to the messages only in Multi mode.

Note 2: The X5 volume is determined by multiplying Volume Controller No. 7 and Expression Controller No. 11.

Note 3: Use RPN to select a parameter for editing, then use the Data Entry parameter to set the selected parameter. Control number 100 (value: 00-02) and 101 (value: 00 fixed) will select a parameter. The following tables show the various parameters that respond to Data Entry Controllers No. 6 and No. 38.

Controller No.		
06	38	Pitch Bend (semitone)
00	00	0
01	00	+1
⋮	⋮	⋮
12	0	+12

Controller No.		
06	38	Coarse Tune (semitone)
40	00	-24
⋮	⋮	⋮
52	00	-12
⋮	⋮	⋮
64	00	0
⋮	⋮	⋮
88	00	+24

Controller No.		
06	38	Fine Tune (cent)
32	00	-50
⋮	⋮	⋮
48	00	-25
⋮	⋮	⋮
64	00	0
⋮	⋮	⋮
96	00	+50

For example, if you wish to set Transpose (Coarse Tune) of a track on MIDI Channel 1 to -12, transmit [Bn, 64, 02, 65, 00] to the X5 to select Coarse Tune RPN. Then send [Bn, 06, 34, 26, 00] to set the value to -12.

To select Coarse Tune RPN on most sequencers, set Controller 100 to 02, and Controller 101 to 00. To set the value to -12, set Controller 6 to 52 (which corresponds to -12) and Controller 38 to 00.

Note 4: When the value is 64, the Program setting will be used. Settings below 63 reduce the time, and settings above 65 increase the time.

Note 5: When the value is 64, the Program setting will be used. Settings below 63 make the sound darker, while settings above 65 make the sound brighter.

Sending Control Change messages (0-127) via the modulation wheel of the X5 allows you to control the external MIDI devices (page 162). Refer to the manual of the MIDI device you wish to control.

MIDI Panpot, Send Data

The following tables show MIDI panpot and send data.

MIDI Panpot Messages [Bn, 0A, vv]
(Controller #10)

Panpot	
MIDI In Pan data (vv)	X5 Pan
0 - 2	A15
3 - 6	A14
7 - 10	A13
11 - 15	A12
16 - 19	A11
20 - 23	A10
24 - 27	A9
28 - 32	A8
33 - 36	A7
37 - 40	A6
41 - 44	A5
45 - 49	A4
50 - 53	A3
54 - 57	A2
58 - 62	A1
63 - 66	CNT
67 - 70	B1
71 - 74	B2
75 - 79	B3
80 - 83	B4
84 - 87	B5
88 - 91	B6
92 - 96	B7
97 - 100	B8
101 - 104	B9
105 - 108	B10
109 - 113	B11
114 - 117	B12
118 - 121	B13
122 - 125	B14
126 - 127	B15

On the X5, use Send Level C controller #91 to control Reverb Depth [Bn, 5B, vv], and Send Level D controller #93 to control Chorus Depth [Bn, 5D, vv].

Send	
MIDI IN Send data (vv)	X5 Send
0 - 13	0
14 - 26	1
27 - 40	2
41 - 53	3
54 - 67	3
68 - 80	5
81 - 94	6
95 - 107	7
108 - 121	8
122 - 127	9

Troubleshooting

Problem	Solution	P
Nothing is displayed on the LCD when the POWER switch is turned on.	Check that the power cable is connected to a suitable AC outlet.	5
The X5 does not produce any sound.	Check the connections to your amplifier, mixer, headphones, etc.	5
	Check that your amplifier, mixer, etc., is switched on, and the correct settings have been made.	3
	Check that the X5 MASTER VOLUME slider is up.	153
	Is Local Control turned off? It should be on.	153
The wrong sounds are produced.	Check that the MIDI Channel of incoming data matches the Global MIDI Channel on the X5 in Program Play mode.	97
	Check that you play keys within the specified note range on the keyboard.	104
	Did you save the edit using the Write function? (You do not need to write your edits for a Drum kit.)	71
Sound cannot be stopped.	Have you selected the Program that was selected when you edited the Drum kit?	70
	Did you edit the Program after you selected it for the Combination?	161
The X5 does not respond to incoming MIDI data.	Make sure that the current Program's Hold parameter is not set to ON.	70
	Is the Damper Polarity parameter set incorrectly?	161
	Make sure that all MIDI cables are connected correctly. Make sure that the X5 is set to receive MIDI data on the channel that the sending device is using.	7-10 96, 111, 152 11
The X5 does not respond to incoming MIDI data.	When you control from an external MIDI device, make sure the External Out Select parameter in Global mode is set to MIDI (for controlling via MIDI) or to *PCIF (for controlling via TO HOST).	153
	Make sure that the X5 is not set to filter out the incoming MIDI data. The MIDI filter parameter in Global mode should not be set to "DIS."	153
The X5 does not respond to incoming computer data.	Make sure that the computer cable is connected correctly.	9, 10
	Make sure that the External Out Select parameter in Global mode is set to PCIF.	154
	Make sure that the Computer Select in Global mode is set correctly.	11
Cannot write a Program or Combination.	Is the Program memory protect function set to ON?	154
Keys do not play the specified drum sounds.	Is the Transpose function set to something other than +00?	147
	Is the oscillator octave parameter set to 8'?	71
In Combination Play mode, Combinations cannot be selected using MIDI Program Change messages.	Make sure that the Program Change Filter is set to ENA or NUM.	153
In Combination Play mode or Multi mode, Programs cannot be selected using MIDI Program Change messages.	Make sure that each Timbre/Track's Program Change Filter parameter is set to E.	100, 109
	Make sure that the Bank of the Program to be selected matches the Bank specified by MIDI Bank Select messages.	163
In Combination Play mode or Multi mode, sound is produced only when certain keys are played.	Perhaps some Timbres' Key Window parameters are set to produce a keyboard split.	97, 110
Cannot select VDF2, VDA2 or Pitch2 Modulation parameters.	The currently-selected Program is not Double mode.	70
Cannot play GM compatible song data correctly.	Make sure that the song data is GM compatible.	31
	You must conform the selected X5 song to GM using Multi setup parameters.	32
Make sure that the settings in Global mode have been made correctly.		
Transpose data or Velocity Curve data is not received or transmitted correctly.	Make sure that the Trans position in Global mode has been set correctly.	

General Error Messages

Error Message	Meaning
Battery Low (Internal)	The voltage of the internal battery is low. Please contact your Korg dealer to have the battery replaced. Do not attempt to replace the battery yourself.

Program Edit Mode & Combination Edit Mode Error Messages

Error Message	Meaning
Memory Protected	The Program or Combination memory into which you are trying to write data is protected.

Global Mode Error Messages

Error Message	Meaning
Invalid Data	You have tried to set a narrow range Modulation Wheel Calibration Set parameter. Please contact your Korg dealer if this message appears repeatedly after you take corrective action.

Specifications

	X5D	X5
Tone Generation System	AI ² (Advanced Integrated) Synthesis	
Tone Generator	Single mode: 64 voice, 64 oscillators Double mode: 32 voice, 64 oscillators	Single mode: 32 voice, 32 oscillators Double mode: 16 voice, 32 oscillators
Keyboard	61 key	
PCM Waveform Memory	PCM 8MB	PCM 6MB
Effects	Two digital multi-effects processors, 47 effects	
Programs	236 (100 internal RAM, 136 internal ROM)	
Combinations	100 internal RAM,	
Number or Preset Data	Program, Combination: 200 each (100 in PRE-a, 100 in PRE-b) Drum Kits: 4 (2 in PRE-a, 2 in PRE-b)	Program, Combination: 100 each Drum Kits: 2
Control Inputs	Assignable pedal/switch	
Outputs	L/MONO, R, PHONES (stereo mini jack)	
MIDI Connections	IN, OUT, THRU	
Communication port	TO HOST	
LCD	16 x 2 LCD with backlight	
Power Supply	DC 12V	
Power Consumption	700mA	
Dimensions (W x D x H)	900 (W) x 254.2 (D) x 83.4 (H) mm	
Weight	4.5kg	
Accessory	AC adapter	

Appearance and specifications subject to change without notice.

Options

- AG-001 IBM-PC connection kit (Cable, "KORG MIDI Driver" software)
- AG-002 Macintosh connection kit (Cable, "KORG MIDI Driver" software)
- AG-004 9-pin/25-pin adapter for IBM-PC
- PS-1, PS-2 Pedal switch
- DS-1 Damper pedal
- EXP-2, XVP-10 Expression pedal

Using MIDI exclusive messages

Each manufacturer is free to use exclusive messages in whatever way they desire, unlike other types of MIDI message where the function of each message is fixed by the MIDI specification. Exclusive messages are used mainly to transmit patch data.

Although the format of exclusive messages is different for each manufacturer, the format of Korg exclusive messages is as shown below.

STRUCTURE OF KORG X5 SYSTEM EXCLUSIVE MESSAGES

1st Byte = 1111 0000 (F0):	Exclusive Status	} EX. Header
2nd Byte = 0100 0010 (42):	Korg ID	
3rd Byte = 0011 gggg (3g):	Format ID g: Global ch.	
4th Byte = 0011 0101 (36):	X5 ID	
5th Byte = 0fff ffff (ff):	Function Code (See Func Code List)	
6th Byte = 0ddd dddd (dd):	Data	
⋮	⋮	
LastByte = 1111 0111 (F7):	End of Exclusive ----- EOX	

The fifth byte (the function ID) determines what the exclusive message will do. For the various types, refer to the function code list (1-4, 2-5).

The action of sending a set of sound data etc. is called Data Dump, and this can be initiated in the Data Dump page of GLOBAL mode, or by receiving an appropriate dump request message.

Since the model ID of the X5D is the same as that of the X5, these two models can exchange exclusive data each other. However, when the X5 receives any of Multisounds 340-429 and Drum Sounds 164-214, "No Assign" message will appear.

Also, the model ID of the X5 is the same as that of the 05R/W, and the X5 is able to exchange exclusive data with the 05R/W. However, be aware that for Multi Setup data and Global data,

Notes on each type of message

- **No.11 Program Write Request**

When you enter Program Edit mode, the data of that program will be written into the Edit Buffer (the write source), so writing should be done in Program Edit mode. It is possible to write while in Program mode, but in this case, after selecting a program, you must go through Program Edit mode once in order for writing to take place correctly.

- **No.41 Parameter Change, No.53 Drum Parameter Change, No.4E Mode Change**

Control Change #06, 26, Data Entry, #60, 61 Data Increment, Decrement

When you change modes from the X5 front panel, a 'Mode Change' will be transmitted, and each time you select a parameter in Program Edit, Combination Edit or Multi modes, a 'Parameter Change' will be transmitted. When you move the slider, 'Data Entry' will be transmitted. When you press [▲] or [▼], 'Data Increment' or 'Data Decrement' will be sent.

By sending these messages to the X5, the X5's parameters can be edited individually, but messages must be transmitted in succession starting with the first 'Mode Change.' Even if the appropriate messages have been transmitted to edit via MIDI, once the panel keys or sliders have been operated, editing via MIDI will no longer be possible. In this case, you must once again begin transmitting from the 'Mode Change' (refer to Tables 7-10).

- Some of the parameters in Multi mode (listed below) do not respond to 'Parameter Change' messages. To edit these, you must use 'Multi Data Dump (exp).'

The various MIDI data filters (except Program) for each track
 Key Window Bottom for each track
 Velocity Window Bottom for each track
 MIDI channel for each track

In Global mode, individual editing is possible only for drum kit parameters, and for this type of editing you will use 'Drum Parameter Change' messages. The procedure is the same as for 'Parameter Change' messages.

When you send the Parameter Change messages for Multisounds 340-429 and Drum Sounds 164-214 from the X5D to the X5, the X5 will select Multisound 339 and Drum Sound 163 respectively.

- **No.51 Global Data Dump parameters** include some which are not found on the 05R/W (listed below). Since these parameters are transmitted using unused areas of 05R/W data format, they can be transmitted and received between two X5 units. When this data is transmitted from an X5 to an 05R/W, it will be ignored, and when transmitted from an 05R/W, the data will have values of 0.

Damper polarity
 Assignable pedal assign
 Assignable switch assign

- **No.68 Multi Setup Data (expansion) Dump** is used to transmit settings for each track. No.55 Multi Setup Data Dump is used to transmit effect unit settings of the multi. By using these two messages, you can transmit Multi mode settings. The Multi Data dump operation in Global mode transmits these two types of data in a single operation. The All Data dump operation also transmits No.68 immediately following No.50 All Data Dump. However each type of data will be transmitted independently when the corresponding dump request is received. The 05R/W uses only No.55.

- When exclusive data is received and processing has been completed, it will transmit a 'Data Load Completed' (ACK) message. However if the format of the received data was incorrect a message of 'Format Error' will be transmitted, and if the receiving X5 was not set appropriately (e.g., if memory protect was turned on) a message of 'Load Error' (NAC) will be transmitted.

Although not an exclusive message, when a Program Change is received while the Exclusive Filter is set to ENA, a message of 'Data Load Completed' will be transmitted after processing is finished.

- While communicating with a personal computer etc. via the PC interface, MIDI transmission and reception is disabled. The opposite also applies.

MIDI Data Format

1-3 UNIVERSAL SYSTEM EXCLUSIVE MESSAGES (DEVICE INQUIRY REPLY)

Byte [H]	Description
F0	Exclusive Status
7E	Non Realtime Message
08	MIDI GLOBAL CHANNEL (DEVICE ID)
06	INQUIRY MESSAGE
02	IDENTITY REPLY
42	KORG ID
36	KS ID (MANUFACTURERS ID)
00	(FAMILY CODE (LSB))
09	(" " (MSB))
00	(MEMBER CODE (LSB))
00	(" " (MSB))
**	(Minor Ver. (LSB))
00	(" " (MSB))
**	(Major Ver. (LSB))
00	(" " (MSB))
F7	END OF EXCLUSIVE

03R/W and X5 series are family
 Member code = 0 : 03R/W
 = 9 : X5
 = 14: X5DR
 = 1D: X5D

Transmits when INQUIRY MESSAGE REQUEST Received

1-4 Transmits Function Code List

Func [H]	Description	R	D	E	C
42	MODE DATA	○			
4E	MODE CHANGE				○*2
41	PARAMETER CHANGE				○*3
53	DRUMKIT PARAMETER CHANGE				○*4
40	PROGRAM PARAMETER DUMP	○			○*5
4C	ALL PROGRAM PARAMETER DUMP	○	○		
49	COMBINATION PARAMETER DUMP	○			
4D	ALL COMBINATION PARAMETER DUMP	○	○		○*7
55	MULTI SETUP DATA DUMP	○	○		○*7
68	MULTI SETUP DATA (Exp) DUMP	○	○		○*7
51	GLOBAL DATA DUMP	○			
52	DRUMS DATA DUMP	○			
50	ALL DATA GLOBAL DRUMS COMBI PROG, MULTI) DUMP	○			○*8
26	RECEIVED MESSAGE FORMAT ERROR				
23	DATA LOAD COMPLETED (ACK)				
24	DATA LOAD ERROR (NAK)				
21	WRITE COMPLETED				
22	WRITE ERROR				

Transmitted when

R : Request Message is received
 D : Data dump by SW (Don't respond to Exclusive ENA, DIS)
 E : EX Message received
 C : Mode or No. is changed by SW

Some Request Message is not received in some mode. See 2-5.
 * When transmits series of EX Messages to X5, Wait until [DATA LOAD COMPLETED] or [WRITE COMPLETED] of Several Messages was received.

- *2 : Transmits when change a mode.
- *3 : Transmits when select a parameter in PROGRAM EDIT, COMBINATION EDIT, MULTI mode.
- *4 : Transmits when select a DrumKit's parameter in GLOBAL mode.
- *5 : Transmits when enter the PROGRAM EDIT mode.
- *6 : Transmits when change a Combination No.
- *7 : At first, transmits [MULTI SETUP DATA], and next transmits [MULTI SETUP DATA (exp)].
- *8 : At first, transmits [ALL DATA], and next transmits [MULTI SETUP DATA (exp)].

MIDI IMPLEMENTATION

1-1 TRANSMITTED DATA

1-1 CHANNEL MESSAGES [D]: Decimal, [H]: Hex

Status [Hex]	Second [D]	Third [D]	Fourth [H]	Description	E, R, A
8g	kk (kk)	vv (vv)		Note Off kk=24~108 vv=8~127 (61Keys*Transpose)	A
9g	kk (kk)	vv (vv)		Note On kk=24~108 vv=8~127 (61Keys*Transpose)	A
Bg	00 (00)	mm (mm)		Bank Select(MSB) (BANK Key) *1	P
Bg	01 (01)	vv (vv)		Modulation 1 (Mod Wheel : Control1)	C
Bg	02 (02)	vv (vv)		Modulation 2 (Mod Wheel : Control2)	C
Bg	04 (04)	00/127 (00/7F)		Pedal SW (A. Pedal SW : Scale = Main/Sub)	C
Bg	06 (06)	vv (vv)		Data Entry (MSB) (Value Slider)	E
Bg	07 (07)	vv (vv)		Volume (Assignable Pedal : Volume)	E
Bg	11 (0B)	vv (vv)		Expression (Assignable Pedal : Expression)	C
Bg	12 (0C)	vv (vv)		Effect Control (Assignable Pedal : Effect)	C
Bg	32 (20)	bb (bb)		Bank Select(LSB) (BANK Key) *1	P
Bg	38 (26)	vv (vv)		Data Entry (LSB) (Value Slider)	E
Bg	64 (40)	00/127 (00/7F)		Hold1 Off/On (A. Pedal SW : Damper = Off/On)	C
Bg	74 (4A)	vv (vv)		Brightness (Assignable Pedal : Cutoff)	C
Bg	82 (5C)	00/127 (00/7F)		Effect1 Level (FX1 Off/On)	C
Bg	94 (5E)	00/127 (00/7F)		Effect2 Level (FX2 Off/On)	C
Bg	96 (60)	00 (00)		Data Increment (Value Up Key)	E
Bg	97 (61)	00 (00)		Data Decrement (Value Down Key)	E
Bg	0~127	vv (vv)		Control Changes (Modulation Wheel)	C
Cg	pp (pp)	-		Program Change (Program/Combination Change) *1	P
Dg	vv (vv)	-		Channel Pressure (Mod Wheel : After Touch)	T
Eg	bb (bb)	bb (bb)		Bender Change (Pitch bend Wheel)	C

g : Always Global Channel No. (0~15)
 vv : Value

ENA = A : Always Enabled
 C : Enabled when Control Filter in GLOBAL mode is ENA
 P : Enabled when Program Filter in GLOBAL mode is ENA, NUM
 T : Enabled when After Touch Filter in GLOBAL mode is ENA
 E : Enabled when Exclusive Filter in GLOBAL mode is ENA

*1 : Program : MIDI Out [Hex]
 BankA 00~99 : mm, bb, pp = 00, 00, 00~63
 " G 01~128 : " 38, 00, 00~7F
 " G 129 : " 3E, 00, 00
 " G 130 : " 3E, 00, 10
 " G 131 : " 3E, 00, 19
 " G 132 : " 3E, 00, 20
 " G 133 : " 3E, 00, 28
 " G 134 : " 3E, 00, 40
 " G 135 : " 3E, 00, 18
 " G 136 : " 3E, 00, 30

1-2 SYSTEM REALTIME MESSAGES

Status [H]	Description
FE	Active Sensing

2. RECOGNIZED RECEIVE DATA

2-1 CHANNEL MESSAGES [D]:Decimal, [H]:Hex

Status [Hex]	Second [D] [H]	Third [D] [H]	Description (Use for)	E N A
8n	kk (kk)	xx (xx)	Note Off (Note Off)	A
9n	kk (kk)	00/vv (00/vv)	Note Off/On vv=1~127 (Note Off/On)	A
Bn	00 (00)	mm (mm)	Bank Select(MSB) (Bank Select)	#1 P
Bn	01 (01)	vv (vv)	Modulation1 Depth (Pitch MG)	C
Bn	02 (02)	vv (vv)	Modulation2 Depth (VDF MG)	C
Bn	04 (04)	≦63/≦64 (≦3F/≦40)	Foot Pedal Off/On (Select Main/Sub Scale)	C
Bn	06 (06)	vv (vv)	Data Entry (MSB) (RPN, EX Param Change)	C/E
Bn	07 (07)	vv (vv)	Volume (Volume)	C
Bn	10 (0A)	vv (vv)	Panpot (A:B Panpot)	C
Bn	11 (0B)	vv (vv)	Expression (Volume)	C
Bg	12 (0C)	vv (vv)	Effect Control (FX Dyna Mod Src= PEDAL1)	C
Bg	13 (0D)	vv (vv)	Effect Control (FX Dyna Mod Src= PEDAL2)	C
Bn	32 (20)	bb (bb)	Bank Select(LSB) (Bank Select)	#1 P
Bn	38 (26)	vv (vv)	Data Entry (LSB) (RPN, EX Param Change)	C/E
Bn	64 (40)	≦63/≦64 (≦3F/≦40)	Hold Off/On (Damper Off/On)	C
Bn	72 (48)	vv (vv)	Release Time (VDF/A Release Time)	#2 C
Bn	73 (49)	vv (vv)	Attack Time (VDA Attack Time)	#2 C
Bn	74 (4A)	vv (vv)	Brightness (VDF Cutoff)	#2 C
Bn	91 (5B)	vv (vv)	Reverb Level (Send C Level)	C
Bg	92 (5C)	00/≧1 (00/≧01)	Effect1 Level (FX1 Off/On)	C
Bn	93 (5D)	vv (vv)	Chorus Level (Send D Level)	C
Bg	94 (5E)	00/≧1 (00/≧01)	Effect2 Level (FX2 Off/On)	C
Bn	96 (60)	00 (00)	DATA Increment (RPN, EX Param Change)	C/E
Bn	97 (61)	00 (00)	DATA Decrement (RPN, EX Param Change)	C/E
Bn	100 (64)	rr (0r)	RPN Param No. (LSB) (RPN Param Select)	#3 A
Bn	101 (65)	00 (00)	RPN Param No. (MSB) (RPN Param Select)	#3 A
Bn	120 (78)	00 (00)	All Sound Off (All Sound Off)	C
Bn	121 (79)	00 (00)	Reset All Controllers(Reset All Controllers)	C
Bg	122 (7A)	00/127 (00/7F)	Local Control Off/On (Local Control Off/On)	A
Bn	123 (7B)	00 (00)	All Notes Off (All Notes Off)	A
Bn	124 (7C)	00 (00)	Omn mode Off (All Notes Off)	A
Bn	125 (7D)	00 (00)	Omn mode On (All Notes Off)	A
Bn	126 (7E)	≦16 (≦10)	Mono mode On (All Notes Off)	A
Bn	127 (7F)	00 (00)	Poly mode On (All Notes Off)	A
Cn	pp (pp)	---	Program Change (Prog. Comb Change)	#1, 4 P
Dn	vv (vv)	---	Channel Pressure (After Touch)	T
En	bb (bb)	bb (bb)	Bender Change (Pitch Bend)	C

n : MIDI Channel No. (0~15) ----- Usually Global Channel.
 When in Combi/Multi mode, each timbre's/track's channel.
 g : Always Global Channel No. (0~15)

x : Random

ENA = A : Always Enabled

C : Enabled when Control Filter in GLOBAL mode is ENA
 P : Enabled when Program Filter in GLOBAL mode is ENA, (NUM, PRG)
 T : Enabled when After Touch Filter in GLOBAL mode is ENA
 E : Enabled when Exclusive Filter in GLOBAL mode is ENA

#1 : MIDI In (Hex) Program
 mm, bb, pp = 00, 00, 00~63 : BankA 00~99
 00, 00, 64~7F : " A 00~27
 38, xx, 00~7F : " G 01~128
 39, xx, 00~7F : " G 01~128
 3A~3D, xx, xx : OFF #1-1
 3E, xx, 00~0F : BankG 129
 3E, xx, 10~17 : " G 130
 3E, xx, 18 : " G 135
 3E, xx, 19 : " G 131
 3E, xx, 1A~1F : " G 135
 3E, xx, 20~27 : " G 132
 3E, xx, 28~2F : " G 133
 3E, xx, 30~37 : " G 136
 3E, xx, 38~3F : " G 129
 3E, xx, 40~47 : " G 134
 3E, xx, 48~7F : " G 129
 3F, xx, xx : OFF #1-1

xx : Random
 #1-1: Only in MULTI mode.

MIDI In (Hex) Combination
 pp = 00~63 : 00~99
 64~7F : 00~27

#2 : vv ≦3F : Fast or Dark
 =40 : Doesn't change
 ≧41 : Slow or Bright

#3 : rr = 0 : Each Track's Pitch Bend Sens (Only in MULTI mode).
 = 1 : Each Track's Detune (When Received Ch = Global Ch.
 = 2 : Each Track's Transpose (Only in MULTI mode). Act as Master Tune (Other mode).

#4 : After Processing (While Exclusive ENA),
 Transmits Exclusive Message[DATA LOAD COMPLETED]or[DATA LOAD ERROR].

2-2 SYSTEM REALTIME MESSAGES

Status[H]	Description
FE	Active Sensing

2-3 UNIVERSAL SYSTEM EXCLUSIVE MESSAGE (NON REALTIME)

Byte[H]	Description
F0	EXCLUSIVE STATUS
7E	NON REALTIME MESSAGE
gg	MIDI CHANNEL #5
0a	SUB ID 1 #6
0b	SUB ID 2 #6
F7	END OF EXCLUSIVE

#5 : gg = 0~F : Receive if Global Channel
 = 7F : Receive all Channel

#6 : a, b = 06, 01 : INQUIRY MESSAGE REQUEST
 = 09, 01 : GENERAL MIDI SYSTEM MODE ON

2-4 UNIVERSAL SYSTEM EXCLUSIVE MESSAGE (REALTIME)

Byte[H]	Description	
F0	EXCLUSIVE STATUS	
7F	REALTIME MESSAGE	
BB	MIDI CHANNEL	#5
04	SUB ID 1	
0b	SUB ID 2	#7
vv	VALUE(LSB)	#7
mm	VALUE(MSB)	#7
F7	END OF EXCLUSIVE	

#7 : b = 01 : MASTER VOLUME (mm,vv = 00,00~7F,7F : Min~Max)
 = 02 : MASTER BALANCE (mm,vv = 00,00~40,00~7F,7F : L~Center~R)

2-5 SYSTEM EXCLUSIVE MESSAGES

Function Code List

Func[H]	Description	G	C	P	A	No.
12	MODE REQUEST	○	○	○	○	42
10	PROGRAM PARAMETER DUMP REQUEST					40
1C	ALL PROGRAM PARAMETER DUMP REQUEST	◎	○	○	○	4C
19	COMBINATION PARAMETER DUMP REQUEST					49
1D	ALL COMBINATION PARAMETER DUMP REQUEST	◎	○	○	○	4D
06	MULTI SETUP DATA DUMP REQUEST	◎	○	○	○	55
33	MULTI SETUP DATA(exp) DUMP REQUEST	◎	○	○	○	68
0E	GLOBAL DATA DUMP REQUEST	◎	○	○	○	51
0D	DRUMS DATA DUMP REQUEST	◎	○	○	○	52
0F	ALL DATA(GLOBAL, DRUMS, COMBI, PROG, MULTI) DUMP REQ	◎	○	○	○	50
11	PROGRAM WRITE REQUEST					21
1A	COMBINATION WRITE REQUEST					21
40	PROGRAM PARAMETER DUMP					23
4C	ALL PROGRAM PARAMETER DUMP	◎	○	○	○	23
49	COMBINATION PARAMETER DUMP					23
4D	ALL COMBINATION PARAMETER DUMP	◎	○	○	○	23
55	MULTI SETUP DATA DUMP	◎	○	○	○	23
68	MULTI SETUP DATA(exp) DUMP	◎	○	○	○	23
51	GLOBAL DATA DUMP	◎	○	○	○	23
52	DRUMS DATA DUMP	◎	○	○	○	23
50	ALL DATA(GLOBAL, DRUMS, COMBI, PROG, MULTI) DUMP	◎	○	○	○	23
4E	MODE CHANGE					23
41	PARAMETER CHANGE					23
53	DRUM KIT PARAMETER CHANGE	○				23

Receive when in

- G : GLOBAL mode
- ◎ : Does not respond to Exclusive ENA, DIS in DATA DUMP Page
- C : COMBI, E. COMBI mode
- P : PROG, E. PROG mode
- A : ANY OTHER mode

No. : MIDI Out Function No.
 (transmitted after the message has been received)

3. MIDI EXCLUSIVE FORMAT (R : Receive, T : Transmit)

See STRUCTURE OF XORG X5 SYSTEM EXCLUSIVE MESSAGES (Top page)

Omit EXCLUSIVE HEADER([F0], [42], [3g], [36]) and state from FUNCTION CODE here.

(1) MODE REQUEST R

Byte[H]	Description	
12	MODE REQUEST	12H
F7	EOX	

Receives this message, and transmits Func=42 message.

(2) PROGRAM PARAMETER DUMP REQUEST R

Byte[H]	Description	
10	PROGRAM PARAMETER DUMP REQUEST	10H
F7	EOX	

Receives this message, and transmits Func=40 or Func=24 message.

(3) ALL PROGRAM PARAMETER DUMP REQUEST R

Byte[H]	Description	
1C	ALL PROGRAM PARAMETER DUMP REQUEST	1CH
00		
F7	EOX	

Receives this message, and transmits Func=4C or Func=24 message.

(4) COMBINATION PARAMETER DUMP REQUEST R

Byte[H]	Description	
19	COMBINATION PARAMETER DUMP REQUEST	19H
F7	EOX	

Receives this message, and transmits Func=49 or Func=24 message.

(5) ALL COMBINATION PARAMETER DUMP REQUEST R

Byte[H]	Description	
1D	ALL COMBINATION PARAMETER DUMP REQUEST	1DH
00		
F7	EOX	

Receives this message, and transmits Func=4D or Func=24 message.

(6) MULTI SETUP DATA DUMP REQUEST R

Byte[H]	Description	
06	MULTI SETUP DATA DUMP REQUEST	06H
00		
F7	EOX	

Receives this message, and transmits Func=55 or Func=24 message.

(7) MULTI SETUP DATA(expansion) DUMP REQUEST R

Byte[H]	Description	
33	MULTI SETUP DATA(exp) DUMP REQUEST	33H
00		
F7	EOX	

Receives this message, and transmits Func=68 or Func=24 message.

(8) GLOBAL DATA DUMP REQUEST R

Byte[H]	Description	
0E	GLOBAL DATA DUMP REQUEST	0EH
00		
F7	EOX	

Receives this message, and transmits Func=51 or Func=24 message.

(9) DRUMS DATA DUMP REQUEST R

Byte[H]	Description	
0D	DRUMS DATA DUMP REQUEST	0DH
00		
F7	EOX	

Receives this message, and transmits Func=52 or Func=24 message.

(10) ALL DATA(GLOB, DRUM, COMBI, PROG, MULT) DUMP REQUEST R		
0F	ALL DATA(GLB, DRM, CMB, PRG, MLT) DUMP REQ	0FH
00		
F7	EOX	

Receives this message, and transmits Func=50 or Func=24 message.

(11) PROGRAM WRITE REQUEST R		
11	PROGRAM WRITE REQUEST	11H
00		
pp	Write Destination Program No. (0-99)	
F7	EOX	

If pp > 99 pp ← pp-100

Receives this message, writes the data and transmits Func=21 or Func=22 message.

(12) COMBINATION WRITE REQUEST R		
1A	COMBINATION WRITE REQUEST	1AH
00		
pp	Write Destination Combination No. (0-99)	
F7	EOX	

If pp > 99 pp ← pp-100

Receives this message, writes the data and transmits Func=21 or Func=22 message.

(13) PROGRAM PARAMETER DUMP R, T		
40	PROGRAM PARAMETER DUMP	40H
dd	Data	(NOTE 1.2)
...	...	
F7	EOX	

Receives this message & data, save them to Edit Buffer and transmits Func=23 or Func=24 message. Receives Func=10 message, and transmits this message & data from Edit Buffer. When Enter the PROGRAM EDIT Mode, transmits this message & data from Edit Buffer.

(14) ALL PROGRAM PARAMETER DUMP R, T		
4C	ALL PROGRAM PARAMETER DUMP	4CH
00		
dd	Data	(NOTE 1.3)
...	...	
F7	EOX	

Receives this message & data, save them to Internal Memory and transmits Func=23 or Func=24 message. Receives Func=1C message, and transmits this message & data from Internal Memory. When DATA DUMP is executed, transmits this message & data from Internal Memory.

(15) COMBINATION PARAMETER DUMP R, T		
49	COMBINATION PARAMETER DUMP	49H
dd	Data	(NOTE1.4)
...	...	
F7	EOX	

Receives this message & data, save to Edit Buffer and transmits Func=23 or Func=24 message. Receives Func=19 message, and transmits this message & data from Edit Buffer. When the Combi No. is changed by SW, transmits this message & data from Edit Buffer.

(16) ALL COMBINATION PARAMETER DUMP R, T		
4D	ALL COMBINATION PARAMETER DUMP	4DH
00		
dd	Data	(NOTE 1.5)
...	...	
F7	EOX	

Receives this message & data, save to Internal Memory and transmits Func=23 or Func=24 message. Receives Func=1D message, and transmits this message & data from Internal Memory. When DATA DUMP is executed, transmits this message & data from Internal Memory.

(17) MULTI SETUP DATA DUMP R, T		
55	MULTI SETUP DATA DUMP	55H
00		
dd	Data	(NOTE 1.6)
...	...	
F7	EOX	

Receives this message & data, save to Edit Buffer and transmits Func=23 or Func=24 message. Receives Func=06 message, and transmits this message & data from Edit Buffer. When DATA DUMP is executed, transmits this message & data and Func=68 message from Edit Buffer.

(18) MULTI SETUP DATA(expansion) DUMP R, T		
68	MULTI SETUP DATA(expansion) DUMP	68H
dd	Data	(NOTE 1.7)
...	...	
F7	EOX	

These message & data are not compatible with OSR/W

Receives this message & data, save to Edit Buffer and transmits Func=23 or Func=24 message. Receives Func=33 message, and transmits this message & data from Edit Buffer. When DATA DUMP is executed, transmits Func=55 message and this message & data from Edit Buffer.

(19) GLOBAL DATA DUMP R, T		
51	GLOBAL DATA DUMP	51H
00		
dd	Data	(NOTE 1.8)
...	...	
F7	EOX	

Receives this message & data, save to Internal Memory and transmits Func=23 or Func=24 message. Receives Func=0E message, and transmits this message & data from Internal Memory. When DATA DUMP is executed, transmits this message & data from Internal Memory.

(20) DRUMS DATA DUMP R, T		
52	DRUMS DATA DUMP	52H
00		
dd	Data	(NOTE 1.9)
...	...	
F7	EOX	

Receives this message & data, save to Internal Memory and transmits Func=23 or Func=24 message. Receives Func=0D message, and transmits this message & data from Internal Memory. When DATA DUMP is executed, transmits this message & data from Internal Memory.

(21) ALL DATA(GLOBAL, DRUMS, COMBI, PROG, MULTI) DUMP R, T		
50	ALL DATA(GLBL, DRUM, COMB, PROG, MULT) DUMP	50H
00		
dd	Data	(NOTE 1.10)
...	...	
F7	EOX	

Receives this message & data, save to Internal Memory and transmits Func=23 or Func=24 message. Receives Func=0F message, and transmits this message & data from Internal Memory. When DATA DUMP is executed, transmits this message & data from Internal Memory and Func=68 message.

(22) MODE CHANGE R, T		
4E	MODE CHANGE	4EH
0m	Mode Data	(NOTE 11)
00		
F7	EOX	

Receives this message & data, changes the Mode, and transmits Func=23 or Func=24. When the Mode is changed by SW, transmits this message & data.

(23) PARAMETER CHANGE		R, T
41	PARAMETER CHANGE	41H
pp	Parameter No. (LSB bit6~0) (TABLE 7~9)	
pp	Parameter No. (MSB bit13~7) (TABLE 7~9)	
vv	Value (LSB bit6~0) (NOTE 12)	
vv	Value (MSB bit13~7) (NOTE 12)	
F7	EOX	

Receives this message & data, select & change a Parameter and transmits Func=23 or Func=24 message.
When the Parameter No. is changed by SW, transmits this message & data.

(24) DRUM KIT PARAMETER CHANGE		R, T
53	DRUM KIT PARAMETER CHANGE	53H
00		
ss	Index No. (ss=00~119)	
0p	Parameter No. (TABLE10)	
vv	Value (LSB bit6~0) (NOTE 12)	
vv	Value (MSB bit13~7) (NOTE 12)	
F7	EOX	

Receives this message & data, select & change a Parameter and transmits Func=23 or Func=24 message.
When the Parameter No. is changed by SW, transmits this message & data.

(25) MODE DATA		T
42	MODE DATA	42H
0m	Mode Data (NOTE 11)	
00		
00		
04		
F7	EOX	

Receives Func=12 message, and transmits this message & data.

(26) RECEIVED DATA FORMAT ERROR		T
26	RECEIVED DATA FORMAT ERROR	26H
F7	EOX	

When found an error in the received message (ex. data length), transmits this message.

(27) DATA LOAD COMPLETED (ACK)		T
23	DATA LOAD COMPLETED	23H
F7	EOX	

When DATA LOAD, PROCESSING have been completed, transmits this message.

(28) DATA LOAD ERROR (NAK)		T
24	DATA LOAD ERROR	24H
F7	EOX	

When DATA LOAD, PROCESSING have not been completed (ex. protected), transmits this message.

(29) WRITE COMPLETED		T
21	WRITE COMPLETED	21H
F7	EOX	

When DATA WRITE MIDI has been completed, transmits this message.

(30) WRITE ERROR		T
22	WRITE ERROR	22H
F7	EOX	

When DATA WRITE MIDI has not been completed, transmits this message.

NOTE 1 :

DUMP DATA CONVERT n=0~ for NOTE 2~10

DATA (1set = 8bit x 7Byte)

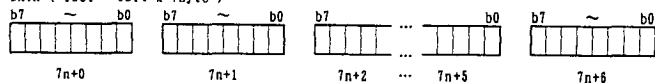

MIDI DATA (1set = 7bit x 8Byte)

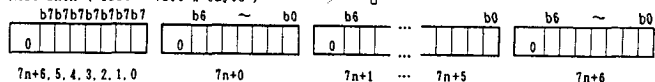

NOTE 2 : PROGRAM PARAMETER (IN CURRENT BUFFER) DUMP FORMAT (See TABLE 1, NOTE 1)
[Parameter No. 00], [Parameter No. 163]
164Bytes = 7x23+3 → 8x23+(1+3) = 188Bytes

NOTE 3 : ALL PROGRAM PARAMETER (IN INTERNAL MEMORY) DUMP FORMAT (See NOTE 1)
[Prog A 00 (164Bytes)], [Prog A 99 (164Bytes)]
164x100Bytes = 7x2342+6 → 8x2342+(1+6) = 18743Bytes (6.0Sec)

NOTE 4 : COMBINATION PARAMETER (IN CURRENT BUFFER) DUMP FORMAT (See TABLE 2, NOTE 1)
[Parameter No. 00], [Parameter No. 135]
136Bytes = 7x19+3 → 8x19+(1+3) = 156Bytes

NOTE 5 : ALL COMBINATION PARAMETER (IN INTERNAL MEMORY) DUMP FORMAT (See NOTE 1)
[Combi 00 (136Bytes)], [Combi 99 (136Bytes)]
136x100Bytes = 7x1942+6 → 8x1942+(1+6) = 15543Bytes (5.0Sec)

NOTE 6 : MULTI SETUP DATA (IN INTERNAL MEMORY) DUMP FORMAT (See TABLE 3, NOTE 1)
[Multi parameter (Effects) (29Bytes)]
29Bytes = 7x4+1 → 8x4+(1+1) = 34Bytes

NOTE 7 : MULTI SETUP DATA (expansion) (IN INTERNAL MEMORY) DUMP FORMAT (See TABLE 4, NOTE 1)
[Multi parameter (expansion) (208Bytes)]
208Bytes = 7x29+5 → 8x29+(1+5) = 238Bytes

NOTE 8 : GLOBAL DATA (IN INTERNAL MEMORY) DUMP FORMAT (See TABLE 5, NOTE 1)
[Global Data (28Bytes)]
28=7x4+0 → 8x4 =32Bytes

NOTE 9 : DRUMS DATA (IN INTERNAL MEMORY) DUMP FORMAT (See TABLE 6, NOTE 1)
[Drum Kit Data (7x60x2Bytes)]
840Bytes =7x120+0 → 8x120 =960Bytes (0.3Sec)

NOTE 10 : ALL DATA (GLOBAL, DRUMS, COMBI, PROG, MULTI) DUMP FORMAT (See NOTE 1)
[Global Data], (See NOTE 8)
[Drums Data], (See NOTE 9)
[All Combination Parameter Data], (See NOTE 5)
[All Program Parameter Data], (See NOTE 3)
[Multi setup Data], (See NOTE 6)
28+840+13600+16400+29Bytes = 7x4413+6
→ 8x4413+(1+6) = 35311Bytes (11.3Sec)

NOTE 11 : **mmmm** = 0 : COMBINATION
 1 : EDIT COMBI.
 2 : PROGRAM
 3 : EDIT PROC.
 4 : MULTI
 5 : GLOBAL

NOTE 12 : VALUE DATA FORMAT (Use at PARAMETER CHANGE, DRUM KIT PARAMETER CHANGE)

Bit15~13 of Value Data is the Sign Flag, and each bit has the same value

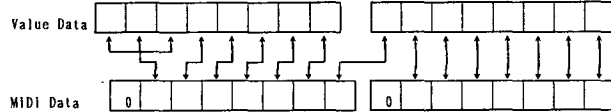

PROGRAM PARAMETER (TABLE 1)

No.	PARAMETERS	DATA(Hex) : VALUE
00	PROGRAM NAME (Head)	20~7F : -
09	PROGRAM NAME (Tail)	-
OSCILLATOR		
10	OSCILLATOR MODE	0, 1, 2 #1
11	ASSIGN HOLD	bit0=0:POL, =1:MON bit1=0:OFF, =1:ON
13	OSC-1 M/D. SOUND(MSB)	#2
14	OSC-1 OCTAVE	FE~01 : 32~4'
15	OSC-2 M/D. SOUND(LSB)	#2
16	OSC-2 M/D. SOUND(MSB)	#2
17	OSC-2 OCTAVE	FE~01 : 32~4'
18	INTERVAL	F4~0C : -12~12
19	DETUNE	CE~32 : -50~50
20	DELAY START	00~63 : 00~99
PITCH EG		
21	START LEVEL	9D~63 : -99~99
22	ATTACK TIME	00~63 : 00~99
23	ATTACK LEVEL	9D~63 : -99~99
24	DECAY TIME	00~63 : 00~99
25	RELEASE TIME	00~63 : 00~99
26	RELEASE LEVEL	9D~63 : -99~99
27	TIME VELOCITY SENSE	9D~63 : -99~99
28	LEVEL VELOCITY SENSE	9D~63 : -99~99
CUTOFF MG		
29	WAVE FORM	bit0~2 : 0~5 #3
	OSC-1 MG ENABLE	bit5=0:OFF, =1:ON
	OSC-2 MG ENABLE	bit6=0:OFF, =1:ON
	KEY SYNC	bit7=0:OFF, =1:ON
30	FREQUENCY	00~63 : 00~99
31	DELAY	00~63 : 00~99
32	INTENSITY	00~63 : 00~99
AFTER TOUCH		
33	PITCH BEND RANGE	F4~0C : -12~12
34	VDF CUTOFF	9D~63 : -99~99
35	VDF MG INT	00~63 : 00~99
36	VDA AMPLITUDE	9D~63 : -99~99
PITCH BEND WHEEL / MODULATION WHEEL		
37	PITCH BEND RANGE	F4~0C : -12~12
38	VDF SWEEP INT.	9D~63 : -99~99
39	VDF MG INT.	00~63 : 00~99
OSC-1 PITCH EG INT.		
40	PITCH EG INT	9D~63 : -99~99
OSC-1 PITCH MG		
41	WAVE FORM	bit0~2 : 0~5 #3
	KEY SYNC	bit7=0:OFF, =1:ON
42	FREQUENCY	00~63 : 00~99
43	DELAY	00~63 : 00~99
44	FADE IN	00~63 : 00~99
45	INTENSITY	00~63 : 00~99
46	FREQ MOD BY KBD TRK	9D~63 : -99~99
47	INTENSITY MOD BY AT	00~63 : 00~99
48	INTENSITY MOD BY MW	00~63 : 00~99
49	FREQ MOD BY AT+MW	00~09 : 0~9
VDF-1		
50	CUTOFF VALUE	00~63 : 00~99
51	KBD TRACK KEY	00~7F : C-1~G9
52	CUTOFF KBD TRACK	9D~63 : -99~99
53	EG INTENSITY	00~63 : 00~99
54	EG TIME KBD TRACK	00~63 : 00~99
55	EG TIME VEL. SENSE	00~63 : 00~99
56	EG INT. VEL. SENSE	9D~63 : -99~99
VDF-1 EG		
57	ATTACK TIME	00~63 : 00~99
58	ATTACK LEVEL	9D~63 : -99~99
59	DECAY TIME	00~63 : 00~99
60	BREAK POINT	9D~63 : -99~99
61	SLOPE TIME	00~63 : 00~99
62	SUSTAIN LEVEL	9D~63 : -99~99
63	RELEASE TIME	00~63 : 00~99
64	RELEASE LEVEL	9D~63 : -99~99
VDA-1		
65	OSCILLATOR LEVEL	00~63 : 00~99
66	KBD TRACK KEY	00~7F : C-1~G9
67	AMP. KBD TRACK INT.	9D~63 : -99~99
68	AMP. VELOCITY SENSE	9D~63 : -99~99
69	EG TIME KBD TRACK	00~63 : 00~99
70	EG TIME VEL. SENSE	00~63 : 00~99
VDA-1 EG		
71	ATTACK TIME	00~63 : 00~99
72	ATTACK LEVEL	00~63 : 00~99
73	DECAY TIME	00~63 : 00~99
74	BREAK POINT	00~63 : 00~99
75	SLOPE TIME	00~63 : 00~99
76	SUSTAIN LEVEL	00~63 : 00~99
77	RELEASE TIME	00~63 : 00~99
OSC-1 EG TIME KBD TRACK, VEL. SW & POLARITY		
78	F. EG TIME K.T SW&POL	bit0~7 #4
79	F. EG TIME VEL. SW&POL	bit0~7 #4
80	A. EG TIME K.T SW&POL	bit0~7 #4
81	A. EG TIME VEL. SW&POL	bit0~7 #4
OSC-1 SEND		
82	SEND D LEVEL	bit0~3 : 0~9
	SEND C LEVEL	bit4~7 : 0~9
COLOR-1		
83	INTENSITY	00~63 : 00~99
84	VELOCITY SENSE	9D~63 : -99~99
VDF-1, VDA-1 KBD TRACK MODE		
85	F-1, A-1 KBD TRACK MODE	#5
OSC-1 PANPOT		
86	A:B PAN	00~1E, FF #6
OSC-2 PARAMETERS		
87	SAME AS OSC-1(40~86)	
88		
133		
134	(RESERVE)	00
EFFECT PARAMETERS		
135		
136		
137		
138		
139		
140		
141		
142		
143		
144		
145		
146		
147		
148		
149		
150		
151		
152		
153		
154		
155		
156		
157		
158		
159		
160		
161		
162		
163		
164		
165		
166		
167		
168		
169		
170		
171		
172		
173		
174		
175		
176		
177		
178		
179		
180		
181		
182		
183		
184		
185		
186		
187		
188		
189		
190		
191		
192		
193		
194		
195		
196		
197		
198		
199		
200		
201		
202		
203		
204		
205		
206		
207		
208		
209		
210		
211		
212		
213		
214		
215		
216		
217		
218		
219		
220		
221		
222		
223		
224		
225		
226		
227		
228		
229		
230		
231		
232		
233		
234		
235		
236		
237		
238		
239		
240		
241		
242		
243		
244		
245		
246		
247		
248		
249		
250		
251		
252		
253		
254		
255		

COMBINATION PARAMETER (TABLE2)

No.	PARAMETERS	DATA(Hex) : VALUE
COMBINATION NAME		
00	COMBI.NAME (Head)	20~7F : ~~~~~
09	COMBI.NAME (Tail)	
10	(RESERVE)	00
EFFECT PARAMETERS		
11		#13
39		
TIMBRE 1 PARAMETERS		
40	PROGRAM NO.	#7
41	OUTPUT LEVEL	00~7F : 00~127
42	TRANSPOSE	E8~18 : -24~24
43	DETUNE	CE~32 : -50~50
44	A:B PAN	00~1E, 1F, FF #6
45	SEND D LEVEL	bit0~3 : 0~9, PRG
	SEND C LEVEL	bit4~7 : 0~9, PRG
46	KEY WINDOW TOP	00~7F : C-1~G9
47	KEY WINDOW BOTTOM	00~7F : C-1~G9
48	VEL.WINDOW TOP	01~7F : 01~127
49	VEL.WINDOW BOTTOM	01~7F : 01~127
50	CONTROL FILTER	#8
51	MIDI CHANNEL	bit0~3 : 1~16
	TIMBRE SW	bit4=0:ON, =1:OFF
TIMBRE 2~8 PARAMETERS		
52	SAME AS TIMBRE 1(40~51) x 7	
135		

MULTI SETUP DATA (Expanded) (TABLE4)

No.	PARAMETERS	DATA(Hex) : VALUE
TRACK 1 PARAMETERS		
00	PROGRAM NO.	#7
01	OUTPUT LEVEL	00~7F : 00~127
02	TRANSPOSE	E8~18 : -24~24
03	DETUNE	CE~32 : -50~50
04	A:B PAN	00~1E, 1F, FF #6
05	SEND D LEVEL	bit0~3 : 0~9, PRG
	SEND C LEVEL	bit4~7 : 0~9, PRG
06	KEY WINDOW TOP	00~7F : C-1~G9
07	KEY WINDOW BOTTOM	00~7F : C-1~G9
08	VEL.WINDOW TOP	01~7F : 01~127
09	VEL.WINDOW BOTTOM	01~7F : 01~127
10	CONTROL FILTER	#8
11	MIDI CHANNEL	bit0~3 : 1~16
	TRACK SW	bit4=0:ON, =1:OFF
TRACK 2~16 PARAMETERS		
12	SAME AS TRACK 1(00~11) x 15	
191		
192	PITCH BEND RANGE	F4~0C : -12~12
193	SAME AS TRACK 1(192) x 15	
207		

MULTI SETUP DATA (TABLE3)

No.	PARAMETERS	DATA(Hex) : VALUE
EFFECT PARAMETERS		
00		
28		#13

GLOBAL PARAMETER (TABLE5)

No.	PARAMETERS	DATA(Hex) : VALUE
GLOBAL PARAMETERS		
00	MASTER TUNE	CE~32 : -50~50
01	KEY TRANSPOSE	F4~0C : -12~12
02	DAMPER POLARITY	00 : J, 01 : J
03	ASSIGNABLE PEDAL	00~05 #9
04	ASSIGNABLE SWITCH	00~05 #10
05	MAIN SCALE TYPE	00~0A #11
06	MAIN SCALE KEY	00~0B : C~B
07	USER SCALE	CE~32 : -50~50
18		
19	VELOCITY CURVE	0~7 : 1~8
20	AFTER TOUCH CURVE	0~7 : 1~8
21	SUB SCALE TYPE	00~0A #11
22	SUB SCALE KEY	00~0B : C~B
23~27	(RESERVE)	00

DRUMS PARAMETER (TABLE6)

DRUM KIT A:1-INDEX#0		
00	DRUMSOUND NO.	#12
01	KEY	0C~73 : C0~G8
02	A:B PAN	bit0~4 #13
	EXCLUSIVE ASSIGN	bit5~7 #18
03	TUNE	88~78 : -120~120
04	LEVEL	9D~63 : -99~99
05	DECAY	9D~63 : -99~99
06	SEND D LEVEL	bit0~3 : 0~9
	SEND C LEVEL	bit4~7 : 0~9
DRUM KIT A:1-INDEX#1 ~ DRUM KIT A:2-#59		
07	SAME AS DRUM KIT A:1-#0(00~06)	
839		x(60x2-1)

#1 : 0 : SINGLE
1 : DOUBLE
2 : DRUMS

#2 : When at Single/Double mode
000 : Multisound 0
153 : Multisound 339
000 : Multisound 0
1A D : Multisound 429
When at Drums mode
00 : Drum Kit A1
01 : " A2
08 : ROM Drum Kit 1
0F : " 8

#3 : 0 : TRIANGLE
1 : UP SAW
2 : DOWN SAW
3 : SQUARE1
4 : RANDOM
5 : SQUARE2

#4 : bit0 : ATTACK TIME SW =0:OFF, =1:ON
bit1 : DECAY TIME SW "
bit2 : SLOPE TIME SW "
bit3 : RELEASE TIME SW "
bit4 : ATTACK TIME POLARITY =0:+, =1:-
bit5 : DECAY TIME "
bit6 : SLOPE TIME "
bit7 : RELEASE TIME "

#5 : bit0,1 ... for VDF 0 : OFF
bit4,5 ... for VDA 1 : LOW
2 : HIGH
3 : ALL

#6 : 00 : A15
0F : CNT
1E : B15
1F : PRG (Only Combi data)
FF : OFF

#7 00~63 : A00~A99
00~87 : G01~G136

#8 : bit0 : PROGRAM CHANGE =0:DIS, =1:ENA
bit1 : DAMPER "
bit2 : AFTER TOUCH "
bit3 : CONTROL CHANGE "
bit4,5=1,1 (fixed)
bit6,7=0,0 : Bank A Program
0,1 : " G "

Program is selected by #7 and #8(bit6,7)

#9 : 0 : OFF
1 : VOLUME
2 : EXPRESSION
3 : VDF CUTOFF
4 : EFFECT CONTROL 1
5 : DATA ENTRY

#10 : 0 : DAMPER
1 : PROGRAM(COMBINATION) UP
2 : " " DOWN
3 : EFFECT 1 ON/OFF
4 : " 2 "
5 : SCALE CHANGE

#11 : 0 : EQUAL TEMP
1 : EQUAL TEMP 2
2 : PURE MAJOR
3 : PURE MINOR
4 : ARABIC
5 : PYTHAGOREAN
6 : WERKMEISTER
7 : KIRNBGER
8 : SLEND
9 : PELOG
A : USER ALE

#12 : 0 : OFF
1 : 00
A4 : 163
0 : OFF
1 : 00
D7 : 214

#13 : bit0~4 = 00 : A15
0F : CNT
1E : B15
1F : OFF
bit5~7 = 0 : EX Off
1 : EX Group1
6 : EX Group6
7 : Self

#13 EFFECT PARAMETER

No.	PARAMETER	DATA(Hex) : VALUE
(00)	Effect 1 Type No.	0.1~2F:OFF.1~47
(01)	" 2 "	0.1~2F:OFF.1~47
(02)	" 1 L-Ch E. Balance	00~64 : 00~100
(03)	" 1 R-Ch "	00~64 : 00~100
(04)	" 2 L-Ch "	00~64 : 00~100
(05)	" 2 R-Ch "	00~64 : 00~100
(06)	Output 3 Pan	00,01~65 #13-1
(07)	" 4 "	00,01~65 #13-1
(08)	Effect 1/O	bit5=0 #13-2
(09)	Effect 1 Parameter	#13-3
(10)	"	"
(11)	Effect 1 Mod Source	00~0D #13-4
(18)	Effect 1 Mod Amount	F1~0F : -15~15
(19)	Effect 2 Parameter	#13-3
(20)	"	"
(26)	"	"
(27)	Effect 2 Mod Source	00~0D #13-4
(28)	Effect 2 Mod Amount	F1~0F : -15~15

#13-1 : 00 : Off #13-2 :
 01 : R bit0=0:Effect L-Ch Off.=1:On
 02 : 01:99 bit1=0: " 1 R-Ch Off.=1:On
 " bit2=0: " 2 L-Ch Off.=1:On
 64 : 99:01 bit3=0: " 2 R-Ch Off.=1:On
 65 : L bit4,5=0:Serial
 1:Parallel
 2:Parallel 2
 3:Parallel 3

#13-3 : Effect Parameter (8Byte) 47 Type

offset	PARAMETER	DATA(Hex) : VALUE
1~3:Hall (4,5:Room, 6:Live Stage)		
(00)	Reverb Time	00~61(2F):0.2~9.9(4.9)
(01)	(NUL)	00
(02)	High Damp	00~63 : 00~99
(03)	Pre Delay	00~C8 : 00~200
(04)	E.R Level	00~63 : 00~99
(05)	(NUL)	00
(06)	EQ High	F4~0C : -12~12
(07)	EQ Low	F4~0C : -12~12

Don't display NUL from here, and that must be 00
 7:Wet Plate, 8:Dry Plate, 9:Spring

(00)	Pre Delay(L)	00~C8 : 00~200
(01)	" " (H)	"
(02)	E.R Level	01~0A : 01~10
(03)	Reverb Time	00~63 : 00~99
(04)	High Damp	00~63 : 00~99
(06)	EQ Low	F4~0C : -12~12
(07)	EQ High	F4~0C : -12~12

10~12:Early Reflection 1,2,3

(00)	E.R Time	00~46 : 100~800
(01)	Pre Delay	00~C8 : 00~200
(06)	EQ High	F4~0C : -12~12
(07)	EQ Low	F4~0C : -12~12

13:Stereo Delay, 14:Cross Delay

(00)	Delay Time L (L)	00~1F4 : 00~500
(01)	" " (H)	"
(02)	Feed Back	9D~63 : -99~99
(03)	High Damp	00~63 : 00~99
(04)	Delay Time R (L)	00~1F4 : 00~500
(05)	" " (H)	"
(06)	EQ High	F4~0C : -12~12
(07)	EQ Low	F4~0C : -12~12

15: Dual Delay

(00)	Delay Time L (L)	00~1F4 : 00~500
(01)	" " (H)	"
(02)	Feed Back L	9D~63 : -99~99
(03)	High Damp L	00~63 : 00~99
(04)	Delay Time R (L)	00~1F4 : 00~500
(05)	" " (H)	"
(06)	Feed Back R	9D~63 : -99~99
(07)	High Damp R	00~63 : 00~99

16~18:Multi Tap Delay 1,2,3

(00)	Delay Time 1(L)	00~1F4 : 00~500
(01)	" " (H)	"
(02)	Delay Time 2(L)	00~1F4 : 00~500
(03)	" " (H)	"
(04)	Feed back	9D~63 : -99~99
(06)	EQ Low	F4~0C : -12~12
(07)	EQ High	F4~0C : -12~12

19,20:Stereo Chorus 1,2

(00)	Mod Depth	00~63 : 00~99
(01)	Mod Speed	00~D8 #13-3-2
(02)	MG Status #13-3-3	bit0=0:Sin.=1:Tri. bit1 ← 1 bit2 ← 0
(04)	Delay Time	00~C8 : 00~200
(06)	EQ High	F4~0C : -12~12
(07)	EQ Low	F4~0C : -12~12

21:Quadrature Chorus, 22:X Over Chorus

(00)	Delay Time L	00~FA : 00~250
(01)	Delay Time R	00~FA : 00~250
(02)	Mod Speed	01~63 : 01~99
(03)	Mod Depth	00~63 : 00~99
(04)	Mod Waveform	EB~14 #13-3-4
(06)	EQ Low	F4~0C : -12~12
(07)	EQ High	F4~0C : -12~12

23:Harmonic Chorus

(00)	Delay Time L (L)	00~1F4 : 00~500
(01)	" " (H)	"
(02)	Delay Time R (L)	00~1F4 : 00~500
(03)	" " (H)	"
(04)	Mod Speed	01~63 : 01~99
(05)	Mod Depth	00~63 : 00~99
(06)	Filter Split Point	00~12 : 00~18

24:Symphonic Ensemble

(00)	Mod Depth	00~63 : 00~99
(06)	EQ High	F4~0C : -12~12
(07)	EQ Low	F4~0C : -12~12

25,26:Flanger1,2, 27:X Over Flanger

(00)	Delay Time	00~C8 : 00~200
(01)	Mod Depth	00~63 : 00~99
(02)	Mod Speed	01~63 : 01~99
(03)	Resonance	9D~63 : -99~99
(06)	EQ Low	F4~0C : -12~12
(07)	EQ High	F4~0C : -12~12

28:Exciter

(00)	Blend	9D~63 : -99~99
(01)	Emphatic Point	01~0A : 01~10
(06)	EQ High	F4~0C : -12~12
(07)	EQ Low	F4~0C : -12~12

29:Enhancer

(00)	Harmonic Density	01~63 : 01~99
(01)	Hot Spot	01~14 : 01~20
(02)	Stereo Width	00~63 : 00~99
(03)	Delay	01~63 : 01~99
(06)	EQ Low	F4~0C : -12~12
(07)	EQ High	F4~0C : -12~12

30:Distortion, 31:Over Drive

(00)	Drive (Edge)	01~6F : 01~111
(01)	Hot Spot	00~63 : 00~99
(02)	Resonance	00~63 : 00~99
(03)	Out Level	00~63 : 00~99
(06)	EQ Low	F4~0C : -12~12
(07)	EQ High	F4~0C : -12~12

32,33:Phaser 1, (2)

(00)	Mod Depth	00~63 : 01~99
(01)	Mod Speed	00~D8 : #13-3-2
(02)	MG Status #13-3-3	bit0=0:Sin.=1:Tri. bit1 ← 1, (0) bit2 ← 0
(03)	Feedback	9D~63 : -99~99
(04)	Manual	00~63 : 00~99

34:Rotary Speaker

(00)	Vibrato Depth	00~0F : 00~15
(01)	Acceleration	01~0F : 01~15
(02)	Slow Speed	01~63 : 01~99
(03)	Fast Speed	01~63 : 01~99

35:Auto Pan, (36:Tremolo)

(00)	Depth	00~63 : 00~99
(01)	Speed	00~D8 : #13-3-2
(02)	MG Status #13-3-3	bit0=0:Sin.=1:Tri. bit1 ← 1, (0) bit2 ← 0
(03)	Shape	9D~63 : -99~99
(06)	EQ High	F4~0C : -12~12
(07)	EQ Low	F4~0C : -12~12

37:Parametric EQ

(00)	Low Freq	00~1D : 00~29
(01)	Low Gain	F4~0C : -12~12
(02)	Mid Freq	00~63 : 00~99
(03)	Mid Gain	F4~0C : -12~12
(04)	Mid Width	00~63 : 00~99
(05)	High Freq	00~1D : 00~29
(06)	High Gain	F4~0C : -12~12

38:Chorus-Delay, 39:Flanger-Delay

(00)	Delay Time	00~32 : 00~50
(01)	Mod Speed	01~63 : 01~99
(02)	Mod Depth	00~63 : 00~99
(03)	Feed back	9D~63 : -99~99
(04)	Delay Time	00~E1 : 00~450
(05)	Feed back	9D~63 : -99~99

40:Delay / Hall

(00)	Delay Time (L)	00~1F4 : 00~500
(01)	Delay Time (H)	"
(02)	Feed Back	9D~63 : -99~99
(03)	High Damp	00~63 : 00~99
(04)	Reverb Time	00~61 : 0.2~9.9
(06)	High Damp	00~63 : 00~99
(07)	Pre Delay	00~96 : 00~150

41:Delay / Room

(00)	Delay Parameter	#13-3-1
(01)	"	"
(03)	"	"
(04)	Reverb Time	00~2F : 0.2~4.9
(06)	High Damp	00~63 : 00~99
(07)	Pre Delay	00~96 : 00~150

42:Delay / Chorus, (43:Delay / Flanger)

(00)	Delay Parameter	#13-3-1
(01)	"	"
(03)	"	"
(04)	Depth	00~63 : 00~99
(05)	Speed	00~D8 #13-3-2
(06)	MG Status #13-3-3	bit0=0:Sin.=1:Tri. bit1 ← 0 bit2 ← 0, (-1)
(07)	Feed Back	0. (9D~63:-99~99)

44:Delay / Distortion, 45:Delay / Over Drive

(00)	Delay Time (L)	00~1F4 : 00~500
(01)	" " (H)	"
(02)	Feed back	9D~63 : -99~99
(03)	Drive	01~6F : 01~111
(04)	Hot Spot	01~63 : 01~99
(05)	Resonance	00~63 : 00~99
(06)	Out Level	01~63 : 01~99

46:Delay / Phaser

(00)	Delay Parameter	#13-3-1
(01)	"	"
(03)	"	"
(04)	Depth	00~63 : 00~99
(05)	Speed	00~D8 #13-3-2
(06)	Feedback	9D~63 : -99~99

47:Delay / Rotary Speaker

(00)	Delay Time (L)	00~1F4 : 00~500
(01)	" " (H)	"
(02)	Feed back	9D~63 : -99~99
(03)	Acceleration	01~0F : 01~15
(04)	Slow Speed	01~63 : 01~99
(05)	Fast Speed	01~63 : 01~99

*13-3-1 : Delay Parameter
Same as 40-(00)~(03)

*13-3-2 : Data(Hex) Value(Hz)
00~63 0.03~ 3.00 (0.03step)
64~C7 3.1 ~13.0 (0.1 step)
C8~D8 14 ~30.0 (1 step)

*13-3-3 : MG Status
bit0 : Wave Form =0:Sin, =1:Tri
bit1 : Phase =0:0°, =1:180°
bit2 : Wave Shape =0: Normal
=1: for Flanger

*13-3-4 : Waveform
EB : T+10
: :
FF : T-10
00 : S-10
: :
14 : S+10

*13-4 : Dynamic Modulation Source
0 : None
1 : Mod Wheel = Cont #1
2 : Mod Wheel = Cont #2
3 : Mod Wheel = After Touch
4 : Asgn Pedal 1
5 : Asgn Pedal 2
6 : Total level of VDA EG

PROGRAM PARAMETERS PARAMETER No. for PARAMETER CHANGE (TABLE 1)

No.	PARAMETERS	No. of TABLE 1
OSCILLATOR		
00	OSC MODE	10
01	ASSIGN	11 bit0
02	HOLD	11 bit1
PITCH EG		
03	START LEVEL	21
04	ATTACK TIME	22
05	ATTACK LEVEL	23
06	DECAY TIME	24
07	RELEASE TIME	25
08	RELEASE LEVEL	26
09	EG INT BY VEL SENSE	28
10	EG TIME BY VEL SENSE	27
CUTOFF MG		
11	WAVE FORM	29 bit0~2
12	FREQUENCY	30
13	INTENSITY	32
14	DELAY	31
15	OSC SELECT	29 bits,6
16	KEY SYNC	29 bit7
AFTER TOUCH		
17	PITCH BEND RANGE	33
18	VDF CUTOFF	34
19	VDF MG INT	35
20	VDA AMPLITUDE	36
BEND WHEEL, MODULATION WHEEL		
21	VDF MG INT	39
22	PITCH BEND RANGE	37
23	VDF SWEEP INT	38
OSC-1		
24	MULTISOUND	12,13
25	LEVEL	65
26	OCTAVE	14
27	PITCH EG INT	40
28	A:B PAN	86
29	SEND C LEVEL	82 bit4~7
30	SEND D LEVEL	82 bit0~3
VDF-1		
31	CUTOFF VALUE	50
32	EG INTENSITY	53
COLOR-1		
33	INTENSITY	83
34	INT BY VEL SENSE	84
VDF-1 EG		
35	ATTACK TIME	57
36	ATTACK LEVEL	58
37	DECAY TIME	59
38	BREAK POINT	60
39	SLOPE TIME	61
40	SUSTAIN LEVEL	62
41	RELEASE TIME	63
42	RELEASE LEVEL	64
43	EG INT BY VEL SENSE	56
44	EG TIME BY VEL SENSE	55

VDF-1 EG TIME MOD BY VEL SENSE		
45	ATTACK TIME	79 bit0,4
46	DECAY TIME	79 bit1,5
47	SLOPE TIME	79 bit2,6
48	RELEASE TIME	79 bit3,7
VDF-1 KBD TRACK		
49	KBD TRACK KEY	51
50	MODE	85 bit0,1
51	CUTOFF	52
52	EG TIME	54
VDF-1 EG TIME MOD BY KBD TRACK		
53	ATTACK TIME	78 bit0,4
54	DECAY TIME	78 bit1,5
55	SLOPE TIME	78 bit2,6
56	RELEASE TIME	78 bit3,7
VDA-1 EG		
57	ATTACK TIME	71
58	ATTACK LEVEL	72
59	DECAY TIME	73
60	BREAK POINT	74
61	SLOPE TIME	75
62	SUSTAIN LEVEL	76
63	RELEASE TIME	77
64	EG INT BY VEL SENSE	68
65	EG TIME BY VEL SENSE	70
VDA-1 EG TIME MOD BY VEL SENSE		
66	ATTACK TIME	81 bit0,4
67	DECAY TIME	81 bit1,5
68	SLOPE TIME	81 bit2,6
69	RELEASE TIME	81 bit3,7
VDA-1 KBD TRACK		
70	KBD TRACK KEY	66
71	MODE	85 bit4,5
72	INTENSITY	67
73	EG TIME	69
VDA-1 EG TIME MOD BY KBD TRACK		
74	ATTACK TIME	80 bit0,4
75	DECAY TIME	80 bit1,5
76	SLOPE TIME	80 bit2,6
77	RELEASE TIME	80 bit3,7
OSC-1 PITCH MG		
78	WAVE FORM	41 bit0~2
79	FREQUENCY	42
80	INTENSITY	45
81	DELAY	43
82	FADE IN	44
83	KEY SYNC	41 bit7
84	FREQ MOD BY KBD TRACK	46
85	FREQ MOD BY A.T+M.Wheel	49
86	INTENSITY MOD BY A.T	47
87	INTENSITY MOD BY M.Wheel	48

OSCILLATOR-2		
88	INTERVAL	18
89	DETUNE	19
90	DELAY START	20
OSC-2 PARAMETERS		
91	SAME AS OSC-1 (24~87)	87
154		133
EFFECT PARAMETERS		
155		
187		(TABLE 7-1)

EFFECT PARAMETERS (TABLE 7-1)

No. of TABLE 7-9	PARAMETERS		
PROG	COMB	MULT	
155	136	144	EFFECT 1 TYPE
156	137	145	EFFECT 2 TYPE
157	138	146	EFFECT 1 OFF/ON
158	139	147	EFFECT 2 OFF/ON
159	140	148	OUT3 PANPOT (Seri. Para1, 2)
160	141	149	OUT4 PANPOT (Seri. Para1, 2)
161	142	150	OUT 3-L LEVEL (Para3)
162	143	151	OUT 3-R LEVEL (Para3)
163	144	152	OUT 4-L LEVEL (Para3)
164	145	153	OUT 4-R LEVEL (Para3)
165	146	154	PLACEMENT
EFFECT 1			
166	147	155	DYNAMIC MOD SOURCE
167	148	156	DYNAMIC MOD INT
168	149	157	PARAMETER 1
174	155	163	PARAMETER 7
175	156	164	BALANCE 1
176	157	165	BALANCE 2
EFFECT 2			
177	158	166	Same (166~176 : PROG)
187	168	176	as (147~157 : COMB) FX1 (155~165 : MULT)

DRUM KIT PARAMETERS

PARAM No. for DRUM PARAM CHANGE (TABLE 5)
n = 0~59 (: Index)

No.	PARAMETER	No. of TABLE 6
0	INDEX No.	----
1	INST NO.	017n
2	KEY	117n
3	TUNE	317n
4	OUTPUT LEVEL	417n
5	DECAY	517n
6	A:B PAN	217n b0~4
7	EXCLUSIVE ASSIGN	217n b5~7
8	C SEND LEVEL	617n b4~7
9	D SEND LEVEL	617n b0~3

COMBINATION PARAMETER

PARAM No. for PARAM CHANGE (TABLE 8)
n = 0~7 (: Timbre 1~8)

No.	PARAMETERS	No. of TABLE 2
0+n	PROGRAM NO.	40.50.51+12n *
8+n	OUTPUT LEVEL	41+12n
16+n	MIDI CHANNEL	51+12n b0~3
24+n	KEY WINDOW TOP	46+12n
32+n	KEY WINDOW BOTTOM	47+12n
40+n	VEL WINDOW TOP	48+12n
48+n	VEL WINDOW BOTTOM	49+12n
56+n	TRANSPOSE	42+12n
64+n	DETUNE	43+12n
72+n	PROGRAM CHANGE FILTER	50+12n b0
80+n	DAMPER FILTER	50+12n b1
88+n	AFTER TOUCH FILTER	50+12n b2
96+n	CONTROL CHANGE FILTER	50+12n b3
104+n	A:B PAN	44+12n
112+n	SEND C LEVEL	45+12n b4~7
120+n	SEND D LEVEL	45+12n b0~3
128~135	(RESERVE)	----
EFFECT PARAMETERS		
136		
168		(TABLE 7-1)

Value	40+12n	50+12n b6,7	51+12n b4
00	----	----	1
01~100	00~99	0,0	0
101~236	0~135	0,1	0

MULTI PARAMETERS

PARAM No. for PARAM CHANGE (Func No. = 41) (TABLE 9)
n = 0~15 (: Track 1~16)

No.	PARAMETERS	No. of TABLE 4
0+n	PROGRAM NO.	00+12n
16+n	LEVEL	01+12n
32+n	PANPOT	04+12n
48+n	SEND C LEVEL	05+12n b4~7
64+n	SEND D LEVEL	05+12n b0~3
80+n	TRANSPOSE	02+12n
96+n	DETUNE	03+12n
112+n	PITCH BEND RANGE	192+n
128+n	PROG CHANGE FILTER	10+12n b0
EFFECT PARAMETERS		
144		
176		(TABLE 7-1)

Program Change and Bank Select Reception in Combination Play Mode

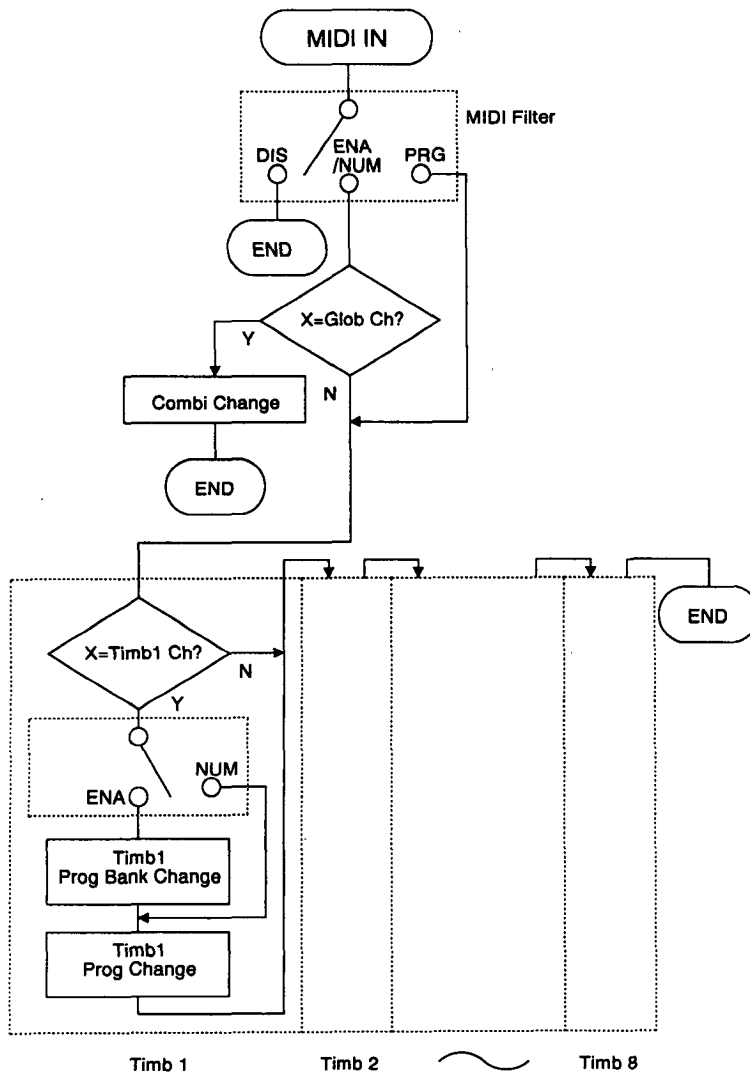

PC Interface Technical Information Chart

PC Interface Technical Notes

PC IF Clock	Description
31.25KBPS	Asynchronous 31.25KBPS 8 bit, 1 stop bit, No parity bit
38.4KBPS	Asynchronous 38.4KBPS 8 bit, 1 stop bit, No parity bit

All MIDI messages described in the MIDI Implementation are also received from PC interface. In addition, the control commands listed below are recognized.

Data	Description
B0 7A 00	Local Control Off (Keyboard model only); Also disables MIDI IN to TG connection
B0 7A 7F	Local Control On (Keyboard model only); Also enables MIDI IN to TG connection
F5 00	Enable PC IF to TG and PC IF to MIDI OUT connection
F5 01	Enable PC IF to MIDI OUT and disable PC IF to TG connection
F5 02	Enable PC IF to TG and disable PC IF to MIDI OUT connection
F5 F5	Transmit one F5 from MIDI OUT
F5 FF	Transmit one FF from MIDI OUT
FF	No operation

On default, all messages from PC IF are recognized by the TG (tone generator) inside X5. After the reception of F5 01, all following messages will be ignored by the TG. On default, all messages from PC IF except FF and F5 xx are also echoed back to MIDI OUT. After the reception of F5 02, all following messages will be sent only to TG and not echoed back to MIDI OUT.

Example:

F5 02 90 3C 40 F5 01 90 3E 40 F5 00 90 40 40

will turn on C(3C) and E(40) notes on X5, and transmit note on messages for D(3E) and E(40) from MIDI OUT.

All messages from MIDI IN are always sent to host via PC IF. On default, all messages from MIDI IN are recognized by the TG as well. After the reception of B0 7A 00 (Local Control Off) from PC IF, all following messages from MIDI IN will be ignored by the TG. B0 7A 7F (Local Control On) will reset to normal operation.

Notes:

1. No handshake means are provided between X5 and the host PC. It is host's responsibility to receive data from the PC IF without overrun.
2. In case 38.4KBPS is used, since X5 has limited amount of MIDI OUT buffer, buffer overrun will occur if data stream to be MIDI OUT is sent via PC IF full in bandwidth. To avoid this, host may insert dummy FF messages every 4th bytes, which will not be transmitted from MIDI OUT.
3. If Line Control is used in an application program, it should be reset to normal state with F5 00 / B0 7A 7F messages after its execution.
4. The F5 xx messages should never be placed in portable sequence files, since they are not legal MIDI messages.
5. Korg MIDI Drivers insert all required messages described above.

Wiring Diagram of Dedicated Connecting Cables

(1) AG-001 (for IBM PC or Compatible)

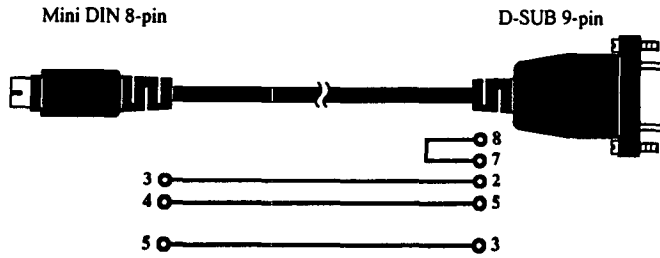

(2) AG-002 (for Macintosh)

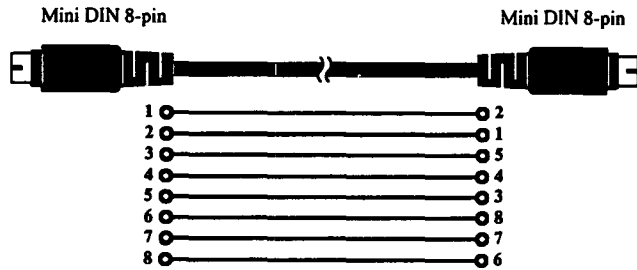

(3) AG-004 (Adapter for IBM PC or Compatible)

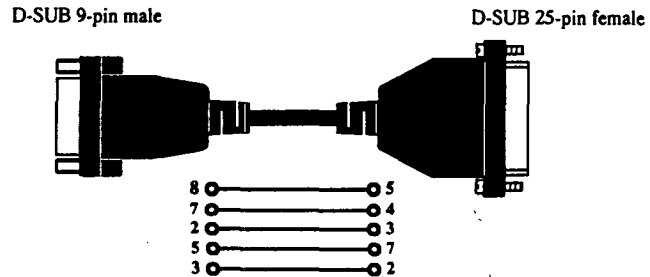

Installing and Setting Up the KORG MIDI Driver

- KORG MIDI Driver is included in the disk that comes with AG-001.

Installing the KORG MIDI Driver in MS Windows

If the application (sequencer, etc.) being used supports Windows MME (Multimedia Extensions), the KORG MIDI Driver program, provided as an accessory, can be used to drive the X5 connected to the serial port (COM port) as a MIDI device.

- MIDI In data may not be received correctly if the processing speed of your computer is inadequate.

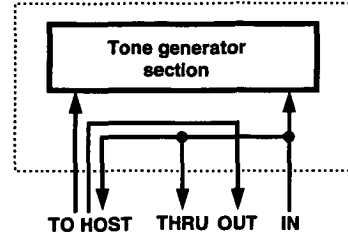

1. Double-click on the Driver icon in the Control Panel.

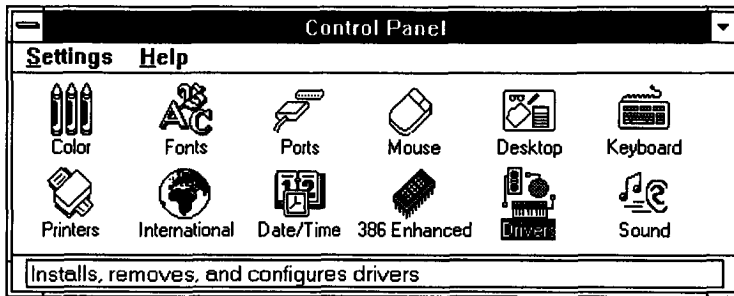

2. Select "Add".

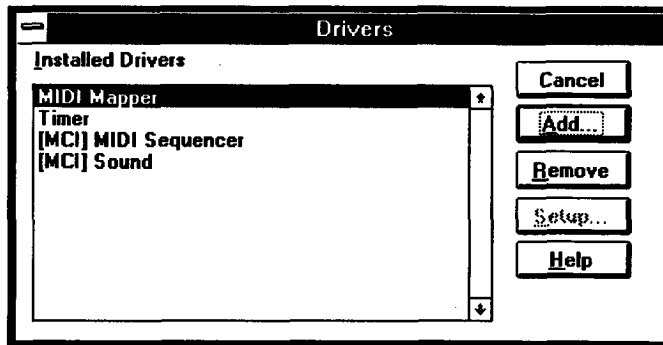

- On the "List Drivers" menu, select "Unlisted or Driver", and click on "OK".

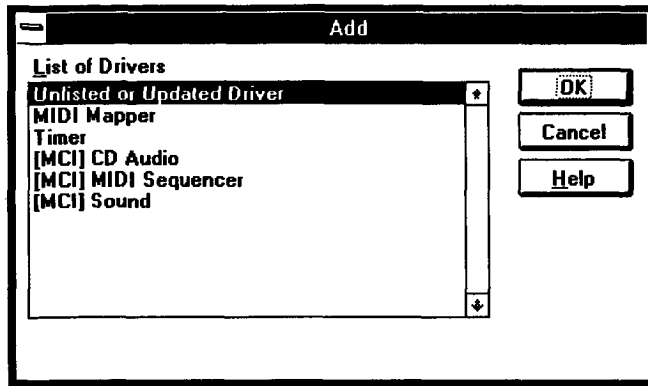

- If a floppy disk containing the Driver program has been inserted in Drive A, type "A:\\" (if the disk is in Drive B, type "B:\"). Then click on "OK".

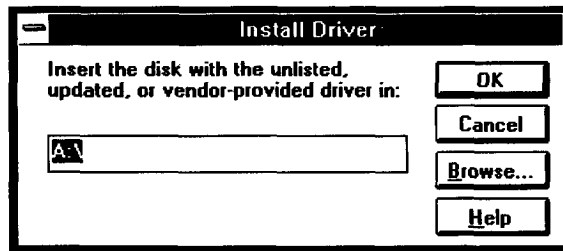

- Select "Korg PC I/F Driver", and click on "OK". The setup screen appears. Follow the instructions listed under "Setting Up the KORG MIDI Driver (Windows)" on page 183

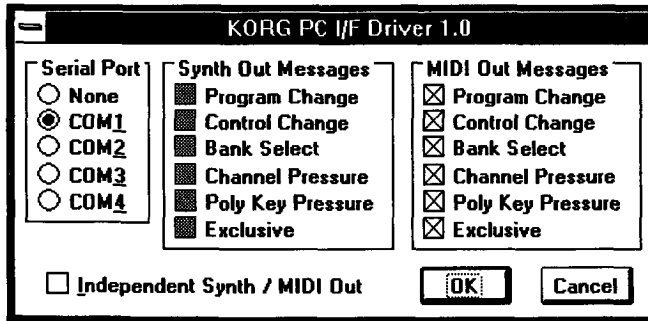

- To make the Driver effective, eject the disk and select "Restart".

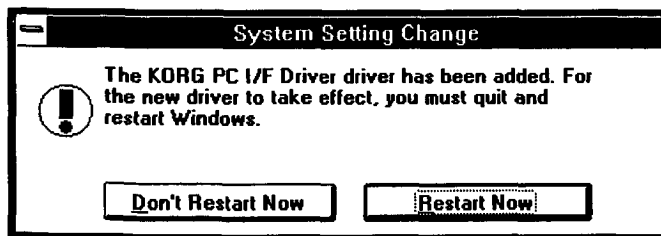

Setting Up the KORG MIDI Driver (Windows)

1. Double-click on the Driver icon in the Control Panel, and select “KORG PC I/F Driver”. Then click on the specified button to display the setup screen.
2. Under “Serial Port”, select the serial port to which the X5 is connected (COM1 to COM4).
If you wish to use the serial port for another purpose after you have already installed the KORG MIDI Driver, delete the Driver or turn the Driver off by selecting “None”.
3. When the “Independent Synth/MIDI Out” box is checked, data output to the Synth Out port will produce sound from the tone generator of the X5, while data output to the MIDI Out port of the X5 will be output as MIDI data from the X5.
If the “Independent Synth/MIDI Out” box is not checked, data output to the MIDI Out port will be sent to both the tone generator of the X5 and the MIDI Out port.
4. The items listed under “Synth Out Messages” can be used to select messages to be sent to the X5. The items listed under “MIDI Out Messages” can be used to select messages to be output from the MIDI Out port on the X5. If the check mark in the box next to “Independent Synth/MIDI Out” is erased, the same messages will be sent to the X5 and output from the MIDI Out port of the X5.
5. When all of the selections have been completed, click on “OK”. To cancel the selections without changing anything, click on “Cancel”.
 - When playing back MS Extended MIDI data, either mute channels 13–16 on the sequencer or whatever instrument is being used, or use the MIDI Mapper provided with the Windows MME program to enter the settings for the Extended MIDI application.

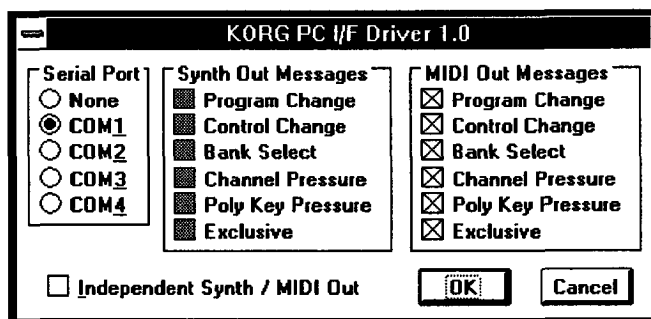

Installing the KORG MIDI Driver on a Macintosh Computer

- KORG MIDI Driver is included in the disk that comes with AG-002.

If the application (sequencer) being used supports the Apple MIDI Manager, the KORG MIDI Driver can be used to provide separate MIDI output for the X5 tone generator and the MIDI Out port.

- When the KORG MIDI Driver is not used
- When the KORG MIDI Driver is used

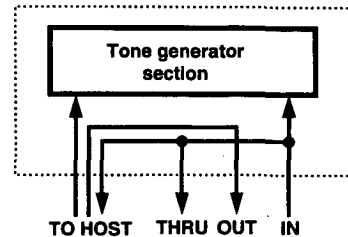
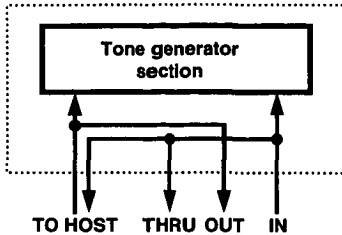

- In order to use the KORG MIDI Driver, the Apple MIDI Manager and PatchBay must be installed.

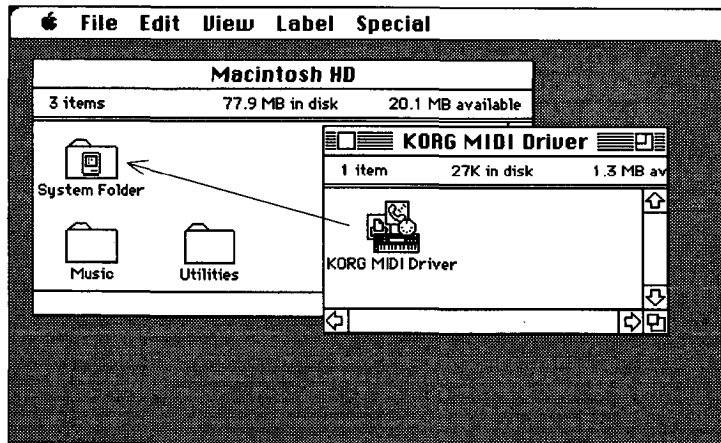

1. Copy the KORG MIDI Driver on the accessory disk into the System Folder on the startup disk.
2. If the Apple MIDI Driver is already in the System Folder, either erase it or move it into another folder. The KORG MIDI Driver includes the functions of the Apple MIDI Driver. Be careful not to erase or move the Apple MIDI Manager.

Setting Up the KORG MIDI Driver for the Macintosh

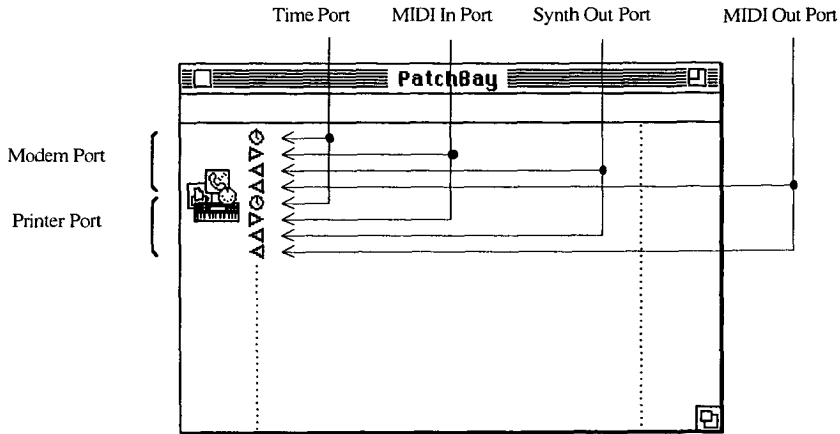

1. Start up the PatchBay program.

If the program has been installed correctly, the KORG MIDI Driver icon will be displayed inside the PatchBay window, as shown above. (The display may differ slightly from the illustration, depending on how the modem and printer ports are set up.)

2. Double-click on the KORG MIDI Driver icon. The setup dialog box is displayed.

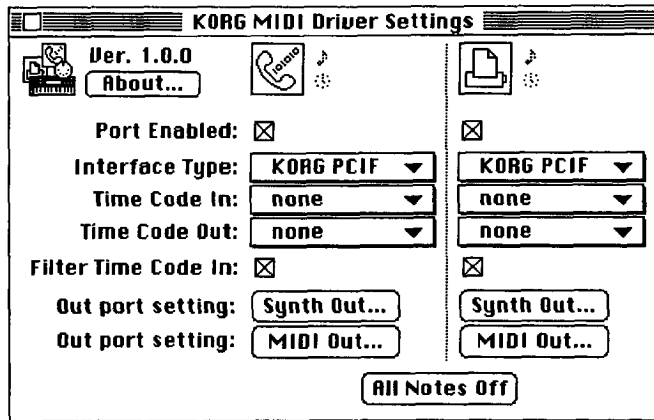

When "KORG PC IF" is selected as the Interface Type, data sent to the Synth Out Port will produce sound from the X5 tone generator, while data sent to the MIDI Out Port will be sent out through the MIDI Out jack on the back panel of the X5.

If "1MHz" is selected as the Interface Type, the Synth Out Port will disappear. Messages sent to the MIDI Out Port will produce sound from the X5 tone generator and also be sent to the MIDI Out Jack on the back panel of the X5.

3. Set the "Interface Type" for the port to which the X5 is connected to "KORG PCIF" (or to "1MHz"). If the X5 is connected to an ordinary MIDI interface, select a clock rate that matches the interface (usually this will be 1 MHz).
4. In order to use the Modem or Printer ports, the Corresponding "Port Enabled" box(s) must be checked. The "Synth Out Port" is available only if "KORG PCIF" has been selected for the interface type.

- Pressing the “Out Port Setting” button displays the dialog box shown below. In this box, you can select the MIDI channels/messages to be output to each of the ports. Only channels/messages which have been checked will be output.

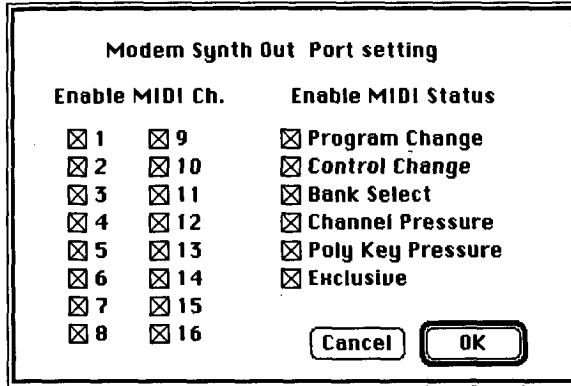

- Drag the mouse from the arrow on the Out Port of the MIDI application (sequencer, etc.) and connect it to the “Synth Out Port” of the Korg MIDI Driver. Other ports can be connected in the same way if necessary.
 - For information on using the PatchBay program, please refer to the application instruction manual included with the PatchBay program, or see the description under “About PatchBay...” in the Apple menu.

MIDI File Translator

MIDI File Translator is an Apple File Exchange translation program that allows Macintosh MIDI application programs to recognize an MS-DOS standard MIDI file as an SMF (Standard MIDI File).

- You do not need this application program to operate the KORG MIDI driver.

Make a copy of MIDI file translator in the folder that contains Apple File Exchange. Select “MIDI File Translation” in the “MS-DOS → Mac” menu that is displayed when you activate Apple File Exchange and insert an MS-DOS disk. If “MIDI File Translation” is not displayed, first select “Other Conversion Program,” then add “MIDI File Translation”.

- For details, see the Apple File Exchange documentation in your Apple manual.

MIDI Implementation Chart

X5D, X5 MIDI Implementation Chart

Function...		Transmitted	Recognized	Remarks
Basic channel	Default	1~16	1~16	Memorized
	Changed	1~16	1~16	
Mode	Default		3	
	Messages	×	×	
	Altered	*****		
Note Number: True voice		24~108	0~127	61 Keys (36~96) + transpose (1 octave)
		*****	0~127	
Velocity	Note ON	○ 9n, V=8~127	○ 9n, V=1~127	Note OFF velocity is applicable only when it is transmitted.
	Note OFF	○ 8n, V=8~127	×	
After Touch	Key's	×	×	Applied via modulation wheel. *A
	Ch's	○	○	
Pitch Bender		○	○	*C
Control	0, 32	○	○	Bank Select (MSB, LSB) *P
	1, 2, 4, 64	○	○	PitchMG, CutoffMG, Scale, Damper *C
	6, 38	○	○	Data Entry (MSB, LSB) *1
	7, 11	○	○	Volume, Expression *C
	10, 91, 93	×	○	A:B Pan Pot, Send C, D *C
	12, 13	○	○	FX1, 2 Cntrl *C
	72, 73	×	○	EG Time (Release, Attack) *C
	74	○	○	Brightness *C

Change	92, 94 96, 97 100, 101 120, 121 0~127	○ ○ × × ○	○ ○ ○ ○ -	FX1, 2 On, Off *C Data Increment/Decrement *1 RPN (LSB, MSB) *2 All Sound Off, Reset All Cntrl Mod Wheel *C
Program Change: True#	○ 0~127 *****	○ 0~127 0~127	*P 0~99 except for Bank G	
System Exclusive	○	○	*3*E	
: Song Pos System Common: Song Sel : Tune	× × ×	× × ×		
System Real Time : Clock : Commands	× ×	× ×		
: Local ON/OFF Aux Messages : All Notes OFF : Active Sense : Reset	× × ○ ×	○ ○ 123~127 ○ ×		
<p>Notes *C, *P, *A, *E: Transmitted and received when MIDI Filter (Control, Program, After Touch, Exclusive) = ENA in global mode.</p> <p>*1 Used for editing with RPN and Exclusive. Transmitted via slider when EX is set to ENA.</p> <p>*2 LSB, MSB =00,00: Pitch Bendrange, =01,00: Finetune, =02,00: Coarse tune</p> <p>*3 Applies to Inquire Message, GM System On, Master Balance, and Master Volume, not Korg exclusive.</p>				

Mode 1 : OMNI ON, POLY

Mode 2 : OMNI ON, MONO

○ : Yes

Mode 3 : OMNI OFF, POLY

Mode 4 : OMNI OFF, MONO

× : No

VOICE NAME LIST

PROGRAM (Preset-a X5D only)

Bank A Preset-a

#	Name	FX1/2 D.Mod.Src	#	Name	FX1/2 D.Mod.Src	#	Name	FX1/2 D.Mod.Src
A00 *	PipeDreams	JS(+Y)/JS(+Y)	A04 *	Rock On!!!	JS(+Y)/JS(+Y)	A08 *	Xanalog	JS(-Y)/ ---
A10 *	Transforms	--- / ---	A14 *	BriteSteel	--- /VDA	A18	LA Synth	--- /JS(+Y)
A20 *	Wave Sweep	JS(+Y)/JS(+Y)	A24 *	Stratified	--- / ---	A28 *	FatFilterz	JS(+Y)/AT
A30 *	Sputnik	JS(+Y)/JS(+Y)	A34 *	Follow Me	JS(+Y)/JS(-Y)	A38 *	MIDI Grand	VDA/JS(+Y)
A40 *	LandingPad	JS(+Y)/JS(-Y)	A44 *	Chruncher	VDA/JS(+Y)	A48 *	Reso Waves	--- / ---
A50 *	Vortex	JS(+Y)/AT	A54 *	Flamenco	--- /JS(-Y)	A58 *	Dr. Tapp	JS(+Y)/JS(+Y)
A60 *	TimeClocks	JS(+Y)/JS(+Y)	A64	Funk Guitr	JS(-Y)/VDA	A68 *	Split Sync	JS(+Y)/JS(+Y)
A70 *	SynTronic	--- /JS(+Y)	A74 *	Rock Chuga	JS(-Y)/JS(-Y)	A78 *	Swell Pad	--- /JS(+Y)
A80 *	Quarks	JS(+Y)/AT	A84 *	FeedbackGt	VDA/VDA	A88 *	Syn Brass	--- /VDA
A90 *	Universe X	JS(+Y)/JS(+Y)	A94 *	Greek Gtr.	--- / ---	A98 *	Solo Synth	AT/JS(+Y)
A01	X Piano	--- /JS(+Y)	A05 *	GlockBells	JS(+Y)/JS(+Y)	A09 @	[KrazyKit]	JS(+Y)/JS(+Y)
A11 *	Killer B	JS(+Y)/AT	A15 *	PingMallet	JS(-Y)/JS(-Y)	A19 @	[ComboKit]	JS(+Y)/JS(+Y)
A21 *	FunkyRoads	JS(+Y)/VDA	A25 *	Crystallce	JS(+Y)/ ---	A29	[Down Low]	--- /JS(+Y)
A31 *	Super Perc	JS(+Y)/ ---	A35 *	Logs&Bells	JS(+Y)/JS(+Y)	A39	[Mr. Gong]	--- /JS(+Y)
A41	M1 Piano	--- /JS(+Y)	A45 *	Star Fire	JS(+Y)/JS(+Y)	A49	[Manimals]	--- /JS(+Y)
A51 *	ClickOrgan	JS(+Y)/ ---	A55 *	MetalGhost	AT/VDA	A59	[Loop SFX]	--- /JS(+Y)
A61 *	Classic EP	JS(+Y)/JS(+Y)	A65 *	RealGamlon	--- /JS(+Y)	A69	[Nature]	VDA/VDA
A71	Super BX - 3	JS(+Y)/ ---	A75 *	ThelceMan	VDA/JS(+Y)	A79	[Natives!]	--- /JS(+Y)
A81 *	Dyno Tines	JS(+Y)/JS(+Y)	A85 *	Swiss Box	JS(+Y)/JS(+Y)	A89 *	[DrillMe!]	JS(+Y)/ ---
A91 *	Big Organ	JS(+Y)/AT	A95 *	Midi Bells	JS(+Y)/ ---	A99 *	[Jet Star]	--- /JS(+Y)
A02 *	BigStrings	--- /JS(+Y)	A06 *	FatRezBass	JS(-Y)/JS(-Y)			
A12 *	Pop Brass	--- /VDA	A16 *	Upright	--- /JS(-Y)			
A22 *	AnaStrings	JS(+Y)/JS(-Y)	A26 *	Dance Bass	--- / ---			
A32 *	BrassSwell	--- /JS(-Y)	A36 *	90's Bass	--- /JS(-Y)			
A42 *	DynoString	JS(+Y)/VDA	A46 *	SynthBass3	JS(+Y)/JS(+Y)			
A52 *	StereoHorn	--- /JS(+Y)	A56 *	Velo Pick	--- /VDA			
A62 *	Cello Ens.	VDA/ ---	A66 *	ChromeBass	JS(+Y)/ ---			
A72 *	Trump Ens.	--- / ---	A76 *	Velo Slap	JS(-Y)/JS(-Y)			
A82 *	VeloFlugel	--- / ---	A86 *	Big Mini	JS(+Y)/ ---			
A92 *	EthnoVioln	--- / ---	A96 *	Stick Bass	JS(-Y)/JS(-Y)			
A03 *	Asian Jung	JS(+Y)/JS(+Y)	A07 *	BreathyVox	--- /JS(-Y)			
A13 *	Harp Gliss	--- /VDA	A17 *	Velo Flute	--- / ---			
A23 *	Euro Pipe	JS(+Y)/JS(+Y)	A27 *	Ghost Vox	VDA/ ---			
A33 *	Lore	VDA/VDA	A37 *	FreshWaves	JS(+Y)/JS(+Y)			
A43	Tamboura	JS(-Y)/JS(-Y)	A47 *	Woodwinds	JS(-Y)/JS(-Y)			
A53	MalletLoop	--- /JS(+Y)	A57 *	oooooooooze	JS(+Y)/JS(+Y)			
A63 *	Godfather	JS(+Y)/JS(+Y)	A67 *	Real Shaku	--- / ---			
A73	Jaw Harp	JS(+Y)/JS(+Y)	A77	Flutter	VDA/JS(+Y)			
A83 *	Polka Box	AT/ ---	A87 *	Arabesque	--- /JS(-Y)			
A93 *	Real Sitar	JS(-Y)/JS(-Y)	A97 *	SopranoVox	--- /JS(+Y)			

Preset-b

Bank G

#	Name	FX1/2 D.Mod.Src	#	Name	FX1/2 D.Mod.Src	#	Name	FX1/2 D.Mod.Src
A00*	Sunrise	--- / ---	A05*	Vibra Bell	JS(-Y)/JS(-Y)	G01	Piano	VDA/VDA
A10*	MachineAge	--- / ---	A15*	Tabla Talk	JS(-Y)/JS(-Y)	G02	BritePiano	VDA/VDA
A20*	GlideSweep	AT/AT	A25	Gamelan	JS(-Y)/---	G03*	HammerPno	--- / ---
A30*	Space Wing	--- / ---	A35*	Dustette	AT/AT	G04*	HonkeyTonk	VDA/VDA
A40	Neutron	--- / ---	A45	SplitBell	JS(-Y)/---	G05	New Tines	--- /VDA
A50*	DreamWorld	JS(-Y)/JS(-Y)	A55*	Africana	--- / ---	G06	Digi Piano	JS(-Y)/---
A60	Spectrum	JS(-Y)/JS(-Y)	A65	Isabelle	--- /VDA	G07	Harpicord	--- /VDA
A70*	InTheTrees	--- / ---	A75	Log Drums	--- /JS(-Y)	G08	Clav	AT/VDA
A80	Halifax NS	--- /VDA	A85	EtherBells	JS(-Y)/JS(-Y)	G09	Celesta	JS(-Y)/VDA
A90	SteamCloud	AT/AT	A95	WaveCycles	JS(+Y)/JS(-Y)	G10	Glocken	JS(-Y)/JS(+Y)
A01	Piano 16'	--- / ---	A06*	XFade Bass	--- /JS(-Y)	G11	Music Box	--- / ---
A11*	Hot Keys	AT/---	A16*	FingerBass	--- /JS(-Y)	G12	Vibes	--- / ---
A21*	Last Tango	--- / ---	A26*	Zap Bass	JS(-Y)/---	G13	Marimba	VDA/---
A31*	Gospel Org	JS(-Y)/AT	A36	PickedBass	JS(-Y)/JS(-Y)	G14	Xylophon	JS(-Y)/JS(-Y)
A41*	PianoHaven	JS(-Y)/JS(-Y)	A46*	Slap It	JS(-Y)/JS(-Y)	G15	Tubular	--- /VDA
A51*	HarpsiFunk	--- / ---	A56*	TechnoBass	AT/---	G16	Santur	--- / ---
A61*	Full Pipes	JS(-Y)/ AT	A66*	Fat Fretty	--- / ---	G17	Full Organ	AT/VDA
A71*	SantaClav	--- / ---	A76*	HouseBass1	--- / ---	G18*	Perc Organ	VDA/VDA
A81*	Drawbars	AT/AT	A86	Bass/Harm	JS(-Y)/JS(-Y)	G19	BX - 3 Organ	VDA/---
A91*	Bouzouki	--- / ---	A96*	Rap Bass	JS(-Y)/---	G20	ChurchPipe	--- /JS(-Y)
A02*	AltoBreath	--- / ---	A07*	TheStrings	--- /JS(-Y)	G21	Positive	--- /AT
A12*	Brass Band	--- /VDA	A17*	LiteVoices	--- /JS(-Y)	G22	Musette	--- /VDA
A22*	MagicFlute	--- / ---	A27*	DigitalAir	JS(-Y)/JS(-Y)	G23	Harmonica	--- /VDA
A32*	Trumpets	--- / ---	A37*	ChamberEns	JS(-Y)/AT	G24	Tango	--- / ---
A42*	Shaku Bend	--- / ---	A47*	AnalogPad	JS(-Y)/JS(-Y)	G25	ClassicGtr	JS(-Y)/JS(-Y)
A52	FlugelHorn	--- / ---	A57*	Airways	--- / ---	G26	A.Guitar	--- /VDA
A62*	Woodwinds	JS(-Y)/JS(-Y)	A67*	Poppin'Pad	--- / ---	G27	JazzGuitar	--- /VDA
A72*	Sfz< Brass	--- /JS(-Y)	A77*	Ambi.Voice	--- /JS(-Y)	G28	Clean Gtr	JS(-Y)/JS(-Y)
A82	Fanfare	--- /JS(-Y)	A87	Air Vox	JS(-Y)/---	G29	MuteGuitar	JS(-Y)/---
A92	BriteBrass	--- / ---	A97*	OoooooPad	--- / ---	G30	Over Drive	JS(-Y)/JS(-Y)
A03*	TinyDancer	--- / ---	A08*	PowerSynth	JS(-Y)/JS(-Y)	G31	DistGuitar	JS(-Y)/JS(-Y)
A13*	Maxi Tine	JS(-Y)/JS(-Y)	A18*	Color Pad	JS(-Y)/---	G32*	RockMonics	JS(-Y)/JS(-Y)
A23*	Operators	--- /JS(-Y)	A28*	Analogist	--- / ---	G33	Jazz Bass	JS(-Y)/JS(-Y)
A33*	Fresh Air	VDA/VDA	A38*	Wire Pad	VDA/VDA	G34	Deep Bass	--- /JS(-Y)
A43*	BowenWave	JS(-Y)/JS(-Y)	A48*	Residue	JS(-Y)/JS(-Y)	G35	Pick Bass	--- /JS(-Y)
A53*	Elec. Tap	--- / ---	A58*	Busy Boy	JS(-Y)/JS(-Y)	G36	Fretless	JS(-Y)/JS(-Y)
A63*	Whirly	JS(-Y)/---	A68	Soft Horns	--- / ---	G37	SlapBass 1	--- / ---
A73	Tine Pad	JS(+Y)/JS(-Y)	A78*	MonoLead	AT/AT	G38	SlapBass 2	AT/---
A83*	Hard Tines	VDA/VDA	A88*	Drum Hit	--- / ---	G39*	SynthBass1	--- / ---
A93	DWGS EP	VDA/VDA	A98	Bright Pad	--- /VDA	G40	SynthBass2	VDA/---
A04*	Spruce Gtr	JS(-Y)/JS(-Y)	A09	Total Kit	JS(+Y)/JS(-Y)	G41	Violin	AT/VDA
A14*	Power Rock	AT/---	A19*	Festival!	VDA/JS(-Y)	G42	Viola	VDA/VDA
A24*	E.Guitars	JS(-Y)/JS(-Y)	A29*	MandoTrem	--- / ---	G43	Cello	AT/VDA
A34*	Rock Mutes	JS(-Y)/JS(-Y)	A39*	Industrial	--- / ---	G44	ContraBass	--- /VDA
A44*	Clean Funk	JS(-Y)/JS(-Y)	A49	Orch Perc	JS(+Y)/JS(-Y)	G45	TremoloStr	--- /VDA
A54	Harmonics	--- /JS(-Y)	A59*	Heartbeat	--- / ---	G46	Pizzicato	JS(+Y)/VDA
A64*	LeadGuitar	JS(-Y)/---	A69	ProducrKit	JS(+Y)/JS(-Y)	G47	Harp	--- /VDA
A74	PedalSteel	JS(-Y)/JS(-Y)	A79*	Hackbrett	--- / ---	G48	Timpani	--- / ---
A84*	Dr.Guitar	JS(-Y)/JS(-Y)	A89	50's SciFi	JS(-Y)/JS(-Y)	G49	Marcato	--- /VDA
A94*	JoyStickUp	JS(+Y)/---	A99*	HarpPluck	JS(-Y)/JS(-Y)	G50	SlowString	--- /VDA

#	Name	FX1/2 D.Mod.Src	#	Name	FX1/2 D.Mod.Src
G51*	Analog Pad	AT/VDA	101*	Brightness	VDA/VDA
G52	String Pad	---/JS(-Y)	102*	Goblin	VDA/VDA
G53	Choir	---/VDA	103	Echo Drop	---/---
G54	Doo Voice	---/---	104*	Star Theme	---/---
G55	Voices	---/VDA	105*	Sitar	---/VDA
G56	Orch Hit	---/---	106	Banjo	---/VDA
G57	Trumpet	---/---	107	Shamisen	VDA/VDA
G58	Trombone	---/VDA	108	Koto	---/VDA
G59	Tuba	AT/VDA	109	Kalimba	---/VDA
G60	Muted Trpt	---/VDA	110*	Scotland	---/VDA
G61*	FrenchHorn	VDA/VDA	111*	Fiddle	AT/VDA
G62	Brass	---/VDA	112	Shanai	---/---
G63*	SynBrass 1	---/VDA	113	Metal Bell	VDA/---
G64*	SynBrass 2	---/AT	114	Agogo	---/---
G65	SopranoSax	---/VDA	115	SteelDrums	---/---
G66	Alto Sax	---/VDA	116	Woodblock	---/---
G67	Tenor Sax	---/VDA	117*	Taiko	---/---
G68	Bari Sax	---/VDA	118	Tom	---/---
G69	Sweet Oboe	AT/AT	119	Synth Tom	VDA/---
G70	EnglishHrn	VDA/VDA	120	Rev Cymbal	JS(-Y)/---
G71	BasoonOboe	AT/---	121	Fret Noise	VDA/VDA
G72	Clarinet	---/VDA	122	NoiseChiff	AT/---
G73	Piccolo	---/VDA	123*	Seashore	JS(-Y)/JS(+Y)
G74	Flute	---/VDA	124*	Birds	---/---
G75	Recorder	AT/VDA	125*	Telephone	---/---
G76	Pan Flute	---/VDA	126*	Helicopter	---/---
G77	Bottle	---/VDA	127*	Stadium!!	JS(-Y)/---
G78	Shakuhachi	---/VDA	128	GunShot	---/---
G79	Whistle	VDA/---	129 @	GM Kit	---/---
G80	Ocarina	---/VDA	130 @	Power Kit	---/---
G81*	SquareWave	VDA/VDA	131 @	Analog Kit	---/---
G82*	Saw Wave	---/VDA	132 @	Jazz Kit	---/---
G83*	SynCaliope	AT/VDA	133 @	Brush kit	---/---
G84*	Syn Chiff	---/---	134 @	Perc Kit	---/---
G85*	Charang	---/VDA	135 @	Dance Kit	---/---
G86*	AirChorus	---/---	136 @	Orch Kit	---/---
G87*	Rezzo4ths	VDA/VDA			
G88*	Bass&Lead	---/---			
G89*	Fantasia	---/---			
G90	Warm Pad	---/---			
G91*	Poly Pad	---/---			
G92	Ghost Pad	---/---			
G93*	BowedGlass	---/---			
G94*	Metal Pad	VDA/VDA			
G95*	Halo Pad	---/---			
G96	Sweep	---/VDA			
G97*	Ice Rain	---/---			
G98*	SoundTrack	---/---			
G99*	Crystal	---/---			
100*	Atmosphere	---/---			

Effect 1/2 Dynamic Modulation Control Source (FX1/2 D.Mod.Src) :

JS = Joystick
AT = After Touch
VDA = VDA EG

* marked programs are "Double Mode" Program.

ⓐ marked programs are "Drum Mode" Program.

COMBINATION

(Preset-a X5D only)

Preset-a

#	Name	FX 1/2 D.Mod.Src	Type	#	Name	FX 1/2 D.Mod.Src	Type
00	SolarFlare	JS(+Y)/JS(+Y)	Layer/VSw	05	HeadHunter	JS(+Y)/---	Layer/VSw
10	<The West>	JS(+Y)/JS(+Y)	Layer/VSw	15	<The East>	---/---	Layer/VSw
20	Warriors	---/---	Layer	25	EthnicOrch	JS(+Y)/JS(+Y)	Layer/VSw
30	AncientSun	JS(+Y)/JS(+Y)	Layer	35	EastAfrica	JS(+Y)/JS(+Y)	Layer/VSw
40	<<Heaven>>	---/---	Layer/VSw	45	Zen Garden	---/---	Layer/VSw
50	Megatron	JS(+Y)/JS(-Y)	Layer/VSw	55	Indian Jam	---/---	Layer/VSw
60	Crossfades	JS(+Y)/JS(+Y)	Layer	65	RhythmPipe	JS(+Y)/JS(+Y)	Layer/VSw
70	New Worlds	JS(+Y)/JS(+Y)	Layer	75	Warm Koto	---/---	Layer
80	Galaxia	JS(+Y)/JS(+Y)	Layer/VSw	85	Lost Tribe	---/JS(+Y)	Layer/VSw
90	The Abyss	---/---	Layer	95	RainForest	JS(+Y)/JS(+Y)	Layer/VSw
01	StereoKeys	---/JS(+Y)	Layer/VSw	06	Rock Organ	JS(+Y)/---	Layer
11	Super EP	JS(+Y)/JS(+Y)	Layer	16	ChorusClav	JS(+Y)/JS(+Y)	Layer/VSw
21	Fat Pianos	JS(+Y)/JS(+Y)	Layer	26	Cathedral	---/JS(+Y)	Layer
31	Velo Roads	JS(+Y)/JS(+Y)	Layer/VSw	36	Ultra Perc	JS(+Y)/---	Layer
41	Rock Piano	JS(+Y)/JS(+Y)	Layer	46	Accordion	VDA/VDA	Layer
51	Bs/EP&Str	JS(+Y)/JS(+Y)	Split	56	Harpicord	---/---	Layer
61	SuperKeys	JS(+Y)/JS(+Y)	Layer	66	FullManual	JS(+Y)/---	Layer
71	Digi Piano	JS(+Y)/---	Layer	76	Rock Show!	---/---	Layer
81	Bass/Piano	---/JS(+Y)	Split	86	DualManual	JS(+Y)/---	Split
91	Piano&Str	---/JS(+Y)	Layer	96	PipeOrgan	JS(+Y)/---	Layer
02	X Strings	---/VDA	Layer	07	X Brass	---/---	Layer
12	Wind ->Orch	---/---	Layer/VSw	17	Bass/Horn	---/VDA	Split/VSw
22	Sonata	VDA/VDA	Layer	27	BrassSwell	---/---	Layer
32	Symphony	---/---	Layer	37	TheSaxMen	JS(+Y)/---	Layer
42	ChamberOrch	---/---	Layer	47	MutedHorns	---/VDA	Layer
52	Fanfare	VDA/VDA	Layer	57	Bass/Brass	---/---	Layer/VSw
62	WoodWinds	---/VDA	Layer/VSw	67	Bows/Trpt	VDA/VDA	Split
72	FullString	VDA/VDA	Layer	77	Big Band	---/VDA	Layer
82	Str/Oboe	VDA/VDA	Split	87	Trpt&Bones	---/---	Layer
92	ChamberStr	---/---	Layer	97	Hot Salsa	---/VDA	Layer/VSw
03	AnalogKing	---/---	Layer	08	TheSingers	VDA/VDA	Layer
13	Maxi Stab	---/---	Layer	18	Ice Bells	JS(+Y)/---	Layer
23	LayerSynth	---/---	Layer	28	Java Bells	JS(+Y)/JS(+Y)	Layer
33	NeuroFunk	---/---	Layer/VSw	38	LunarBells	---/---	Layer
43	Multi Rez	VDA/JS(+Y)	Layer	48	PizzoSynth	JS(+Y)/JS(+Y)	Layer
53	Big Swell	---/---	Layer	58	Moon Stone	JS(+Y)/---	Layer
63	OctaveLead	AT/JS(+Y)	Layer	68	Airiana	---/---	Layer
73	Rezzo Funk	---/---	Layer	78	Vox Bells	---/---	Layer
83	RezzoSplit	---/---	Split	88	Bellendra	JS(+Y)/JS(+Y)	Layer/VSw
93	Hard Sync	JS(+Y)/JS(+Y)	Layer/VSw	98	Prisms	JS(+Y)/---	Layer
04	CrankItUp!	---/---	Layer/VSw	09	Wild Drums	JS(+Y)/JS(+Y)	Layer
14	12 String	---/---	Layer	19	Wild Split	---/---	Layer
24	WaveGuitar	JS(+Y)/JS(+Y)	Layer	29	PhantomSax	---/JS(+Y)	Layer/VSw
34	Slappin'	---/---	Layer/VSw	39	<<<Hell>>>	---/---	Layer
44	Chorus Gtr	JS(-Y)/JS(-Y)	Layer/VSw	49	RapToolKit	---/JS(-Y)	Layer/VSw
54	StickSplit	---/VDA	Split	59	Torquemada	---/---	Layer
64	Malaguena	AT/VDA	Split	69	SpaceZones	JS(+Y)/JS(+Y)	Split
74	Guitar Man	VDA/VDA	Layer/VSw	79	MenAtWork	VDA/JS(+Y)	Layer
84	TheOldWest	---/---	Split	89	Star Lense	---/---	Layer
94	Gtr/Flute	---/JS(-Y)	Split	99	TheDentist	---/---	Layer

Effect 1/2 Dynamic Modulation Control Source (FX1/2 D.Mod.Src):
 JS = Joystick AT = After Touch VDA = VDA EG
 Type : VSw = Velocity Switch

Preset-b

#	Name	FX 1/2 D.Mod.Src	Type	#	Name	FX 1/2 D.Mod.Src	Type
00	Star* Burst	AT/AT	Split/VSw	05	Calcutta	---/---	Split/VSw
10	First* Snow	VDA/VDA	Split	15	Javanese	JS(-Y)/---	Layer
20	Rezolution	JS(-Y)/VDA	Layer	25	Tethnical	---/---	Split/VSw
30	StormOf'30	---/VDA	Layer	35	Bass&Vibes	JS(-Y)/JS(-Y)	Split/VSw
40	Bell Come!	JS(-Y)/JS(-Y)	Layer	45	Instanbul	---/AT	Split/VSw
50	Beach Walk	---/VDA	Layer	55	SugarBells	AT/---	Split/VSw
60	Autumn	---/VDA	Layer	65	Ethno Geo	---/---	Split
70	Child Song	---/---	Split	75	Bolshoi	JS(-Y)/JS(-Y)	Layer
80	SunOfTron	AT/JS(-Y)	Split/VSw	85	The Sphinx	JS(-Y)/JS(-Y)	Split/VSw
90	FreeTime	AT/AT	Split	95	ChinaBell	JS(-Y)/JS(-Y)	Split/VSw
01	LayerPiano	VDA/VDA	Layer	06	FunkySpice	AT/---	Layer
11	Bass&Piano	---/---	Split/VSw	16	L'ilBit O'	---/AT	Layer
21	The Gospel	JS(-Y)/JS(-Y)	Layer/VSw	26	Full Pipe	---/---	Layer
31	Stak'oMidi	---/VDA	Layer	36	Super Perc	---/---	Layer
41	EP&String	---/---	Layer	46	Busy Split	---/---	Split/VSw
51	DynoPiano	---/---	Split	56	Blues Harp	JS(-Y)/---	Layer
61	ElecPno&Bs	---/---	Split/VSw	66	Ruff&Ready	JS(-Y)/JS(-Y)	Layer
71	Pontette	AT/VDA	Layer	76	Wasp Sting	AT/---	Layer
81	SamAntic	JS(-Y)/JS(-Y)	Split/VSw	86	Deep Organ	---/---	Layer
91	Layer Cake	---/---	Layer	96	Sky Cat	AT/JS(-Y)	Layer
02	Synth Fat	JS(-Y)/JS(-Y)	Layer	07	Layer Str	---/JS(-Y)	Layer
12	Full Brass	---/VDA	Split/VSw	17	Philarmoney	JS(-Y)/JS(-Y)	Split/VSw
22	New Rave	JS(-Y)/AT	Split/VSw	27	Overture	JS(-Y)/JS(-Y)	Split/VSw
32	SmokyHorn	---/JS(-Y)	Split	37	Pizz & Bow	JS(-Y)/JS(-Y)	Layer
42	Latin Band	JS(-Y)/JS(-Y)	Split/VSw	47	Orchestral	JS(-Y)/JS(-Y)	Split
52	Centerfold	---/---	Layer	57	Grandioso	JS(-Y)/VDA	Split
62	MasterFunk	---/---	Split/VSw	67	Madrigal	JS(-Y)/JS(-Y)	Layer
72	GoToSweep	JS(-Y)/JS(-Y)	Layer	77	AnaStrings	---/VDA	Layer
82	SweetMutes	---/---	Layer	87	StringsAtk	JS(-Y)/JS(-Y)	Layer
92	BiggerIdea	---/---	Split	97	HarpString	JS(-Y)/JS(-Y)	Layer
03	Satellite	---/---	Layer	08	Sax Heaven	VDA/VDA	Split
13	Sing To Me	---/VDA	Split	18	Half Moons	AT/AT	Layer
23	FlutterPad	---/---	Layer	28	Lead & Pad	JS(-Y)/JS(-Y)	Split
33	VeloVoxBel	---/---	Layer/VSw	38	Aquarium	---/VDA	Split
43	HumanBeam	JS(-Y)/JS(-Y)	Split/VSw	48	CymbalLite	---/---	Layer
53	InTheLight	JS(-Y)/JS(-Y)	Split	58	Osaka Jazz	JS(-Y)/VDA	Split
63	VeloVoices	JS(-Y)/JS(-Y)	Layer/VSw	68	ChiffSplit	---/---	Split
73	SilkRoad33	AT/AT	Split	78	Chris Tall	JS(-Y)/JS(-Y)	Split/VSw
83	Nebulae	JS(-Y)/JS(-Y)	Layer	88	Lassie&Tim	---/---	Split
93	Safari	---/---	Split	98	Night Taps	JS(-Y)/JS(-Y)	Layer
04	Mr. Tone	---/---	Split	09	Celebrate!	JS(-Y)/VDA	Split/VSw
14	Mr.Chorus	JS(-Y)/JS(-Y)	Split/VSw	19	HereltComz	JS(-Y)/JS(-Y)	Split/VSw
24	ShoeString	---/---	Split	29	Dulcimer	AT/---	Layer
34	Siap & Pop	---/---	Layer/VSw	39	HouseParty	JS(-Y)/---	Split/VSw
44	12 Stereo	---/---	Split/VSw	49	Space Port	AT/AT	Split
54	Velo Chord	JS(-Y)/JS(-Y)	Split/VSw	59	Masterfisa	JS(-Y)/JS(-Y)	Layer
64	Split Bass	---/---	Split/VSw	69	Dagobar	JS(-Y)/JS(-Y)	Layer
74	Nashville	---/---	Split	79	Rave Hits	JS(-Y)/VDA	Layer
84	Dole Bee	---/VDA	Split/VSw	89	DeathStars	---/JS(-Y)	Split/VSw
94	Guitar&Pad	JS(-Y)/JS(-Y)	Split	99	Slammin'	JS(-Y)/JS(-Y)	Split/VSw

Drum Kit Map (Preset-a X5D only)

NOTE	Preset-a Drum Kit1	EX. asn	Preset-a Drum Kit2	EX. asn	Preset-b Drum Kit1	EX. asn	Preset-b Drum Kit2	EX. asn
	46
C2	47	046 Orch Crash	off	191 Growl!	off	046 Orch Crash	off	.
	36	000 Fat Kick	off	000 Fat Kick	off	000 Fat Kick	off	004 Punch Kick
	37	001 Rock Kick	off	182 BOOFN	EX1	005 Real Kick	off	003 Crisp Kick
	38	002 Ambi Kick	off	015 Snare 2	off	002 Ambi Kick	off	000 Fat Kick
	39	012 Syn Kick 3	off	188 POOM	EX1	012 Syn Kick 3	off	005 Real Kick
	40	007 Gated Kik	off	186 COUGH	EX1	007 Gated Kik	off	001 Rock Kick
	41	018 PicloSnare	off	181 BISS	EX1	018 PicloSnare	off	002 Ambi Kick
	42	019 Soft Snare	off	173 Pull 1	off	019 Soft Snare	off	007 Gated Kik
	43	027 GatedSnare	off	187 ISSH	EX1	027 GatedSnare	off	009 Metal Kick
	44	029 Syn Snare1	off	171 Drop	off	029 Syn Snare1	off	008 ProceS Kick
45	014 Snare 1	off	185 COOSH	EX1	014 Snare 1	off	006 Dance Kick	
46	036 Side Stick	off	174 Pull 2	off	036 Side Stick	off	012 Syn Kick 3	
C3	47	026 Rock Snare	off	184 CHLACK	EX1	026 Rock Snare	off	010 Syn Kick 1
	48	059 Tom Lo	off	183 BOOGETA	EX1	059 Tom Lo	off	011 Syn Kick 2
	49	060 ProcessTom	off	170 GlassBreak	off	060 ProcessTom	off	013 Orch B.Drm:
	50	059 Tom Lo	off	.	.	059 Tom Lo	off	014 Snare 1
	51	060 ProcessTom	off	170 GlassBreak	off	060 ProcessTom	off	019 Soft Snare
	52	059 Tom Lo	off	191 Growl!	SLF	058 Tom Hi	off	015 Snare 2
	53	048 Tite HH	EX1	191 Growl!	SLF	048 Tite HH	EX1	018 PicloSnare
	54	060 ProcessTom	off	180 Sword	off	051 CloseSynHH:	EX3	017 Snare 4
	55	166 Close HH	EX1	180 Sword	off	048 Tite HH	EX1	016 Snare 3
	56	060 ProcessTom	off	165 Fist	EX2	052 OpenSynHH:	EX3	020 LightSnare
57	049 Open HH	EX1	165 Fist	EX3	049 Open HH	EX1	027 GatedSnare	
58	085 Tambourine	off	204 Tron Up	EX2	085 Tambourine	off	021 TightSnare	
C4	59	050 Pedal HH	EX1	204 Tron Up	EX3	050 Pedal HH	EX1	028 PowerSnare
	60	040 Crash Cym	off	172 CorkPop	off	040 Crash Cym	off	022 Ambi.Snare
	61	040 Crash Cym	off	172 CorkPop	off	040 Crash Cym	off	023 Rev Snare
	62	054 Ride Edge	off	176 HandDrill	SLF	054 Ride Edge	off	026 Rock Snare
	63	055 Ride Cup	off	176 HandDrill	SLF	055 Ride Cup	off	024 RollSnare1
	64	082 SynMaracas	off	189 Uhhh!	SLF	082 SynMaracas	off	025 RollSnare2
	65	081 Cabasa	off	189 Uhhh!	SLF	081 Cabasa	off	036 Side Stick
	66	094 Hand Claps	off	190 Samurai!	SLF	094 Hand Claps	off	029 Syn Snare1
	67	066 Lo Bongo	off	190 Samurai!	SLF	066 Lo Bongo	off	030 Syn Snare2
	68	068 Slap Bongo	off	200 Jetstar	SLF	068 Slap Bongo	off	031 Gun Shot
69	067 Hi Bongo	off	200 Jetstar	SLF	067 Hi Bongo	off	038 VocalSnr 1	
70	086 Cowbell	off	211 MouthHarp1	EX4	086 Cowbell	off	033 BrushSwish	
C5	71	071 Open Conga	off	213 MouthHarp2	EX4	071 Open Conga	off	034 BrushSwirl
	72	071 Open Conga	off	212 MouthHrp1A	EX4	071 Open Conga	off	035 Brush Tap
	73	090 Lo Timbal	off	199 WhiteNoise	off	090 Lo Timbal	off	032 Brush Slap
	74	083 MuteTriang	EX2	031 Gun Shot	off	083 MuteTriang	EX4	048 Tite HH
	75	089 Hi Timbal	off	096 Zap 1	off	089 Hi Timbal	off	049 Open HH
	76	084 OpenTriang	EX2	097 Zap 2	off	084 OpenTriang	EX4	050 Pedal HH
	77	056 Ride Cym 1	off	192 Monkey 1	SLF	098 Scratch Hi	EX2	051 CloseSynHH:
	78	057 Ride Cym 2	off	193 Monkey 2	SLF	099 Scratch Lo	EX2	052 OpenSynHH:
	79	042 China Cym	off	169 MetalHitLo	off	100 ScratchDbl	EX2	040 Crash Cym
	80	023 Rev Snare	EX3	168 MetalHitHi	off	023 Rev Snare	EX5	044 Splash Cym
81	022 Ambi.Snare	EX3	146 Gt Slide	SLF	022 Ambi.Snare	EX5	042 China Cym	
82	024 RollSnare1	EX4	198 Gong Lo	off	024 RollSnare1	EX6	054 Ride Edge	
83	025 RollSnare2	EX4	207 Cast Roll	EX5	025 RollSnare2	EX6	055 Ride Cup	
C6	84	044 Splash Cym	off	107 Castanet	EX5	135 Pole	off	056 Ride Cym 1
	85	167 Stick Hit	off	164 OilDrum	off	030 Syn Snare2	off	057 Ride Cym 2
	86	095 Syn Claps	off	175 SolidHit	off	095 Syn Claps	off	059 Tom Lo
	87	070 Syn Claves	off	101 Thing	off	070 Syn Claves	off	059 Tom Lo
	88	062 SynTom1 Lo	off	196 FingCymbal	off	062 SynTom1 Lo	off	058 Tom Hi
	89	062 SynTom1 Lo	off	179 Scratch c	EX6	062 SynTom1 Lo	off	060 ProcessTom:
	90	037 Syn Rim	off	177 Scratch a	EX6	037 Syn Rim	off	060 ProcessTom:
	91	053 Sagat	off	178 Scratch b	EX6	063 Syn Tom 2	off	062 SynTom1 Lo
	92	101 Thing	off	098 Scratch Hi	EX6	.	.	061 SynTom1 Hi
	93	.	.	099 Scratch Lo	EX6	063 Syn Tom 2	off	.
94	147 Bell Tree	off	100 ScratchDbl	EX6	.	.	063 Syn Tom 2	
95	063 Syn Tom 2	off	064 Brush Tom	
C7	96	201 Windbell	off	161 Orch Hit	Off	147 Bell Tree	off	064 Brush Tom

NOTE	ROM D.Kit 1 (GM Kit)	Ex. asn	ROM D.Kit 2 (Power Kit)	Ex. asn	ROM D.Kit 3 (Analog Kit)	Ex. asn	ROM D.Kit 4 (Jazz Kit)	Ex. asn
	27
28	001:Rock Kick	Off	002:Ambi.Kick	Off	012:Syn Kick 3	Off	003:Crisp Kick	Off
	016:Snare 3	Off	026:Rock Snare	Off	030:Syn Snare2	Off	017:Snare 4	Off
29	049:Open HH	EX1	049:Open HH	EX1	052:Open	EX1	049:Open HH	EX1
31	000:Pat Kick	Off	007:Gated Kik	Off	006:Dance Kick	Off	002:Ambi.Kick	Off
	109:Timbales	Off	109:Timbales	Off	109:Timbales	Off	109:Timbales	Off
33	014:Snare 1	EX6	021:TightSnare	Off	022:Ambi.Snare	Off	025:RollSnare2	EX6
	024:RollSnare1	EX6	023:Rev Snare	Off	023:Rev Snare	Off	024:RollSnare1	EX6
35	005:Real Kick	Off	007:Gated Kik	Off	003:Crisp Kick	Off	004:Punch Kick	Off
C2 36	008:ProcesKick	Off	009:Metal Kick	Off	010:Syn Kick 1	Off	001:Rock Kick	Off
	036:Side Stick	Off	036:Side Stick	Off	037:Syn Rim	Off	036:Side Stick	Off
38	026:Rock Snare	Off	028:PowerSnare	Off	029:Syn Snare1	Off	019:Soft Snare	Off
	094:Hand Claps	Off	094:Hand Claps	Off	095:Syn Claps	Off	094:Hand Claps	Off
40	020:LightSnare	Off	027:GatedSnare	Off	020:LightSnare	Off	015:Snare 2	Off
41	059:Tom Lo	Off	060:ProcessTom	Off	062:SynTom1	Off	059:Tom Lo	Off
	048:Tite HH	EX1	048:Tite HH	EX1	051:CloseSynHH	EX1	048:Tite HH	EX1
43	059:Tom Lo	Off	060:ProcessTom	Off	062:SynTom1	Off	059:Tom Lo	Off
	050:Pedal HH	EX1	050:Pedal HH	EX1	051:CloseSynHH	EX1	050:Pedal HH	EX1
45	059:Tom Lo	Off	060:ProcessTom	Off	062:SynTom1	Off	059:Tom Lo	Off
	049:Open HH	EX1	049:Open HH	EX1	052:Open	EX1	049:Open HH	EX1
47	058:Tom Hi	Off	060:ProcessTom	Off	062:SynTom1	Off	058:Tom Hi	Off
C3 48	058:Tom Hi	Off	060:ProcessTom	Off	062:SynTom1	Off	058:Tom Hi	Off
	040:Crash Cym	Off	040:Crash Cym	Off	052:Open	Off	040:Crash Cym	Off
50	058:Tom Hi	Off	060:ProcessTom	Off	062:SynTom1	Off	058:Tom Hi	Off
	054:Ride Edge	Off	054:Ride Edge	Off	054:Ride Edge	Off	057:Ride Cym 2	Off
52	042:China Cym	Off	042:China Cym	Off	042:China Cym	Off	042:China Cym	Off
53	055:Ride Cup	Off	055:Ride Cup	Off	055:Ride Cup	Off	056:Ride Cym 1	Off
	085:Tambourine	Off	085:Tambourine	Off	085:Tambourine	Off	085:Tambourine	Off
55	044:Splash Cym	Off	044:Splash Cym	Off	044:Splash Cym	Off	044:Splash Cym	Off
	086:Cowbell	Off	086:Cowbell	Off	087:SynCowbell	Off	086:Cowbell	Off
57	040:Crash Cym	Off	040:Crash Cym	Off	040:Crash Cym	Off	040:Crash Cym	Off
	104:Vibraslap	Off	104:Vibraslap	Off	104:Vibraslap	Off	104:Vibraslap	Off
59	056:Ride Cym 1	Off	056:Ride Cym 1	Off	056:Ride Cym 1	Off	054:Ride Edge	Off
C4 60	067:Hi Bongo	Off	067:Hi Bongo	Off	067:Hi Bongo	Off	067:Hi Bongo	Off
	066:Lo Bongo	Off	066:Lo Bongo	Off	066:Lo Bongo	Off	066:Lo Bongo	Off
62	074:Mute Conga	Off	074:Mute Conga	Off	061:SynTom1 Hi	Off	074:Mute Conga	Off
	071:Open Conga	Off	071:Open Conga	Off	061:SynTom1 Hi	Off	071:Open Conga	Off
64	071:Open Conga	Off	071:Open Conga	Off	061:SynTom1 Hi	Off	071:Open Conga	Off
65	089:Hi Timbal	Off	089:Hi Timbal	Off	089:Hi Timbal	Off	089:Hi Timbal	Off
	090:Lo Timbal	Off	090:Lo Timbal	Off	090:Lo Timbal	Off	090:Lo Timbal	Off
67	065:Agogo	Off	065:Agogo	Off	065:Agogo	Off	065:Agogo	Off
	065:Agogo	Off	065:Agogo	Off	065:Agogo	Off	065:Agogo	Off
69	081:Cabasa	Off	081:Cabasa	Off	081:Cabasa	Off	081:Cabasa	Off
	080:Maracas	Off	080:Maracas	Off	082:SynMaracas	Off	080:Maracas	Off
71	150:Whistle S	EX2	150:Whistle S	EX2	150:Whistle S	EX2	150:Whistle S	EX2
C5 72	151:Whistle L	EX2	151:Whistle L	EX2	151:Whistle L	EX2	151:Whistle L	EX2
	105:Guiro S	EX3	105:Guiro S	EX3	105:Guiro S	EX3	105:Guiro S	EX3
74	106:Guiro L	EX3	106:Guiro L	EX3	106:Guiro L	EX3	106:Guiro L	EX3
	069:Claves	Off	069:Claves	Off	070:Syn Claves	Off	069:Claves	Off
76	092:WoodBlock2	Off	092:WoodBlock2	Off	092:WoodBlock2	Off	092:WoodBlock2	Off
	093:WoodBlock3	Off	093:WoodBlock3	Off	093:WoodBlock3	Off	093:WoodBlock3	Off
77	102:Mute Cuica	EX4	102:Mute Cuica	EX4	102:Mute Cuica	EX4	102:Mute Cuica	EX4
	103:Open Cuica	EX4	103:Open Cuica	EX4	103:Open Cuica	EX4	103:Open Cuica	EX4
79	083:MuteTriang	EX5	083:MuteTriang	EX5	083:MuteTriang	EX5	083:MuteTriang	EX5
	084:OpenTriang	EX5	084:OpenTriang	EX5	084:OpenTriang	EX5	084:OpenTriang	EX5
81	084:OpenTriang	EX5	084:OpenTriang	EX5	084:OpenTriang	EX5	084:OpenTriang	EX5
	081:Cabasa	Off	081:Cabasa	Off	081:Cabasa	Off	081:Cabasa	Off
83	149:JingleBell	Off	149:JingleBell	Off	149:JingleBell	Off	149:JingleBell	Off
C6 84	147:Bell Tree	Off	147:Bell Tree	Off	147:Bell Tree	Off	147:Bell Tree	Off
	107:Castanet	Off	107:Castanet	Off	107:Castanet	Off	107:Castanet	Off
86	036:Side Stick	Off	036:Side Stick	Off	036:Side Stick	Off	036:Side Stick	Off
	154:Taiko Lo	Off	154:Taiko Lo	Off	154:Taiko Lo	Off	154:Taiko Lo	Off
87	154:Taiko Lo	Off	154:Taiko Lo	Off	154:Taiko Lo	Off	154:Taiko Lo	Off
A7 105	104							

NOTE	ROM D.Kit 5 (Brush Kit)	Ex. aasn	ROM D.Kit 6 (Perc Kit)	Ex. aasn	ROM D.Kit 7 (Dance Kit)	Ex. aasn	ROM D.Kit 8 (Orch Kit)	Ex. aasn	
28	27	048:Tite HH	EX1	
		003:Crisp Kick	Off	067:Hi Bongo	Off	003:Crisp Kick	Off	050:Pedal HH	EX1
29		108:FingerSnap	Off	066:Lo Bongo	Off	018:PicloSnare	Off	049:Open HH	EX1
	30	049:Open HH	EX1	085:Tambourine	Off	049:Open HH	EX1	054:Ride Edge	Off
31		002:Ambi.Kick	Off	065:Agogo	Off	011:Syn Kick 2	Off	.	.
	32	109:Timbales	Off	038:VocalSnr 1	Off	036:Side Stick	Off	.	.
33		032:Brush Slap	EX6	065:Agogo	Off	021:TightSnare	Off	.	.
	34	024:RollSnare1	EX6	068:Slap Bongo	Off	023:Rev Snare	Off	.	.
35		004:Punch Kick	Off	093:WoodBlock3	Off	002:Ambi.Kick	Off	005:Real Kick	Off
		001:Rock Kick	Off	069:Claves	Off	006:Dance Kick	Off	013:Orch B.Drm	Off
C2	36	036:Side Stick	Off	092:WoodBlock2	Off	036:Side Stick	Off	036:Side Stick	Off
		035:Brush Tap	Off	086:Cowbell	Off	030:Syn Snare2	Off	025:RollSnare2	Off
	39	032:Brush Slap	Off	091:WoodBlock1	Off	094:Hand Claps	Off	107:Castanet	Off
40		033:BrushSwish	Off	107:Castanet	Off	022:Ambi.Snare	Off	025:RollSnare2	Off
		064:Brush Tom	Off	076:Baya 2	Off	060:ProcessTom	Off	.	.
	42	048:Tite HH	EX1	081:Cabasa	Off	048:Tite HH	EX1	.	.
43		064:Brush Tom	Off	075:Baya 1	Off	060:ProcessTom	off	.	.
	44	050:Pedal HH	EX1	080:Maracas	Off	050:Pedal HH	EX1	.	.
45		064:Brush Tom	Off	076:Baya 2	Off	060:ProcessTom	Off	.	.
	46	049:Open HH	EX1	081:Cabasa	Off	049:Open HH	EX1	.	.
47		064:Brush Tom	Off	079:Tabla 3	EX1	060:ProcessTom	Off	.	.
C3	48	064:Brush Tom	Off	078:Tabla 2	EX1	060:ProcessTom	Off	.	.
		040:Crash Cym	Off	104:Vibraslap	Off	040:Crash Cym	Off	.	.
	49	064:Brush Tom	Off	077:Tabla 1	EX1	060:ProcessTom	Off	.	.
50		057:Ride Cym 2	Off	083:MuteTriang	EX3	054:Ride Edge	Off	.	.
	51	042:China Cym	Off	013:Orch B.Drm	Off	042:China Cym	Off	.	.
52		056:Ride Cym 1	Off	084:OpenTriang	EX3	055:Ride Cup	Off	152:Timpani	Off
	54	085:Tambourine	Off	105:Guiro S	EX2	085:Tambourine	Off	085:Tambourine	Off
55		044:Splash Cym	Off	149:JingleBell	Off	044:Splash Cym	Off	044:Splash Cym	Off
	56	086:Cowbell	Off	106:Guiro L	EX2	086:Cowbell	Off	086:Cowbell	Off
57		040:Crash Cym	Off	147:Bell Tree	Off	040:Crash Cym	Off	040:Crash Cym	Off
	58	104:Vibraslap	Off	101:Thing	Off	104:Vibraslap	Off	104:Vibraslap	Off
59		054:Ride Edge	Off	080:Maracas	Off	054:Ride Edge	Off	046:Orch Crash	Off
C4	60	067:Hi Bongo	Off	094:Hand Claps	Off	067:Hi Bongo	Off	067:Hi Bongo	Off
		066:Lo Bongo	Off	095:Syn Claps	Off	066:Lo Bongo	Off	066:Lo Bongo	Off
62		074:Mute Conga	Off	099:Scratch Lo	Off	074:Mute Conga	Off	074:Mute Conga	Off
	63	071:Open Conga	Off	098:Scratch Hi	Off	071:Open Conga	Off	071:Open Conga	Off
64		071:Open Conga	Off	100:ScratchDbl	Off	071:Open Conga	Off	071:Open Conga	Off
		089:Hi Timbal	Off	150:Whistle S	EX4	089:Hi Timbal	Off	089:Hi Timbal	Off
65		090:Lo Timbal	Off	151:Whistle L	EX4	090:Lo Timbal	Off	090:Lo Timbal	Off
	66	065:Agogo	Off	072:Slap Conga	Off	065:Agogo	Off	065:Agogo	Off
67		065:Agogo	Off	074:Mute Conga	Off	065:Agogo	Off	065:Agogo	Off
	68	081:Cabasa	Off	071:Open Conga	Off	081:Cabasa	Off	081:Cabasa	Off
69		080:Maracas	Off	071:Open Conga	Off	080:Maracas	Off	080:Maracas	Off
	70	150:Whistle S	EX2	102:Mute Cuica	Off	150:Whistle S	EX2	150:Whistle S	EX2
C5	72	151:Whistle L	EX2	103:Open Cuica	Off	151:Whistle L	EX2	151:Whistle L	EX2
		105:Guiro S	EX3	109:Timbales	Off	105:Guiro S	EX3	105:Guiro S	EX3
74		106:Guiro L	EX3	088:R - Timbal	Off	106:Guiro L	EX3	106:Guiro L	EX3
	75	069:Claves	Off	089:Hi Timbal	Off	069:Claves	Off	069:Claves	Off
76		092:WoodBlock2	Off	090:Lo Timbal	Off	092:WoodBlock2	Off	092:WoodBlock2	Off
		093:WoodBlock3	Off	070:Syn Claves	Off	093:WoodBlock3	Off	093:WoodBlock3	Off
77		102:Mute Cuica	EX4	087:SynCowbell	Off	102:Mute Cuica	EX4	102:Mute Cuica	EX4
	78	103:Open Cuica	EX4	108:FingerSnap	Off	103:Open Cuica	EX4	103:Open Cuica	EX4
79		083:MuteTriang	EX5	153:Taiko Hi	Off	083:MuteTriang	EX5	083:MuteTriang	EX5
	80	084:OpenTriang	EX5	154:Taiko Lo	Off	084:OpenTriang	EX5	084:OpenTriang	EX5
81		081:Cabasa	Off	097:Zap 2	Off	081:Cabasa	Off	081:Cabasa	Off
	82	149:JingleBell	Off	024:RollSnare1	EX5	149:JingleBell	Off	149:JingleBell	Off
83		147:Bell Tree	Off	025:RollSnare2	EX5	147:Bell Tree	Off	147:Bell Tree	Off
C6	84	107:Castanet	Off	046:Orch Crash	EX6	107:Castanet	Off	107:Castanet	Off
		036:Side Stick	Off	046:Orch Crash	EX6	036:Side Stick	Off	036:Side Stick	Off
	87	154:Taiko Lo	Off	.	.	154:Taiko Lo	Off	154:Taiko Lo	Off
	
A7	105	.	.	161:Orch Hit	Off

Multisound Name (340-429 X5D only)

000 A.Piano 1	054 Funky Gtr	108 MusicBoxLP	162 StringEns.	216 Surfy	270 FingerSnap
001 A.Piano1LP	055 FunkyGtr V	109 Log Drum	163 StrEns. V1	217 SleighBell	271 FingSnapNT
002 A.Piano 2	056 E.Gtr Harm	110 Marimba	164 StrEns. V2	218 Elec Beat	272 Tambourine
003 E.Piano 1	057 DistGuitar	111 Xylophone	165 StrEns. V3	219 Idling	273 Hand Clap
004 E.Piano1LP	058 Dist GtrLP	112 Vibe	166 AnaStrings	220 EthnicBeat	274 HandClapNT
005 E.Piano 2	059 DistGuitrV	113 Celesta	167 PWM	221 Taps	275 Gun Shot
006 E.Piano2LP	060 Over Drive	114 Glocken	168 Violin	222 Tap 1	276 Castanet
007 Soft EP	061 OverDrv LP	115 BrightBell	169 Cello	223 Tap 2	277 CastanetNT
008 Soft EP LP	062 OverDrv F4	116 B.Bell LP	170 Cello LP	224 Tap 3	278 Snap
009 Hard EP	063 MuteDstGtr	117 Metal Bell	171 Pizzicato	225 Tap 4	279 Snap NT
010 Hard EP LP	064 MtDstGtr V	118 M.Bell LP	172 Voice	226 Tap 5	280 Gt Scratch
011 PianoPad 1	065 PowerChord	119 Gamelan	173 Choir	227 Orch Hit	281 Side Stick
012 PianoPad 2	066 PowerChd V	120 Pole	174 Soft Choir	228 SnareRI/Ht	282 SideStikNT
013 Clav	067 OverDvChrd	121 Pole LP	175 Air Vox	229 Syn Snare	283 TimbleSide
014 Clav LP	068 Gtr Slide	122 Tubular	176 Doo Voice	230 Rev Snare	284 TimbSidNT
015 Harpsicord	069 GtrSlide V	123 Split Drum	177 DooVoiceLP	231 PowerSnare	285 Syn Rim
016 HarpsicdLP	070 Sitar 1	124 Split Bell	178 Syn Vox	232 Orch Perc	286 Syn Rim NT
017 PercOrgan1	071 Sitar 2	125 Fiute	179 Syn Vox LP	233 Crash Cym	287 Open HH
018 PercOrg1LP	072 Sitar 2 LP	126 Pan Flute	180 White Pad	234 CrashCymLP	288 OpenSyn HH
019 PercOrgan2	073 Santur	127 PanFluteLP	181 Ether Bell	235 CrashLP NT	289 CloseSynHH
020 PercOrg2LP	074 Bouzouki	128 Shakhuchi	182 E.Bell LP	236 China Cym	290 Sagat
021 Organ 1	075 BouzoukiLP	129 ShakhachLP	183 Mega Pad	237 Splash Cym	291 Sagat NT
022 Organ 1 LP	076 Banjoe	130 Bottle	184 Spectrum 1	238 Orch Crash	292 Sagatty
023 Organ 2	077 Shamisen	131 Recorder	185 Spectrum 2	239 Tite HH	293 Sagatty NT
024 Organ 2 LP	078 Koto	132 Ocarina	186 Stadium	240 Tite HH NT	294 JingleBell
025 Organ 3	079 Uood	133 Oboe	187 Stadium NT	241 Bell Ride	295 Taiko
026 Organ 4	080 Harp	134 EnglishHrn	188 BrushNoise	242 Ping Ride	296 Slap Bongo
027 Organ 5	081 MandlinTrm	135 Eng.HornLP	189 BruNoiseNT	243 Timpani	297 Open Conga
028 RotaryOrg1	082 A.Bass 1	136 BasonOboe	190 Steel Drum	244 Timpani LP	298 Slap Conga
029 RotaryOrg2	083 A.Bass1 LP	137 BsonOboeLP	191 SteelDrmLP	245 Cabasa	299 Palm Conga
030 PipeOrgan1	084 A.Bass 2	138 Clarinet	192 BrushSwirl	246 Cabasa NT	300 Mute Conga
031 PipeOrg1LP	085 A.Bass2 LP	139 ClarinetLP	193 Belltree	247 Agogo	301 Tabla 1
032 PipeOrgan2	086 E.Bass 1	140 Bari Sax	194 BelltreeNT	248 Cow Bell	302 Tabla 2
033 PipeOrg2LP	087 E.Bass1 LP	141 Bari.SaxLP	195 BeltreV NT	249 Low Bongo	303 Maracas
034 PipeOrgan3	088 E.Bass 2	142 Tenor Sax	196 Tri Roll	250 Claves	304 SynMaracas
035 PipeOrg3LP	089 E.Bass2 LP	143 T.Sax LP	197 TriRoll NT	251 Timbale	305 SynMarcsNT
036 Musette	090 Pick Bass1	144 Alto Sax	198 Telephon	252 WoodBlock1	306 MuteTriang
037 Musette V	091 PicBass1LP	145 A.Sax LP	199 TelephonNT	253 WoodBlock2	307 OpenTriang
038 Bandneon	092 Pick Bass2	146 SopranoSax	200 Clicker	254 WoodBlock3	308 Guiro
039 BandneonLP	093 Fretless	147 S.Sax LP	201 Clicker NT	255 Taiko Hit	309 Guiro LP
040 Accordion	094 FretlessLP	148 Tuba	202 Crickets 1	256 Syn Claves	310 Scratch Hi
041 AcordionLP	095 Slap Bass1	149 Tuba LP	203 Crickets1NT	257 Melo Tom	311 ScratchHiNT
042 Harmonica	096 Slap Bass2	150 Horn	204 Crickets 2	258 ProccesTom	312 Scratch Lo
043 G.Guitar	097 SlpBass2LP	151 FlugelHorn	205 Crickets2NT	259 Syn Tom 1	313 ScratchLoNT
044 G.GuitarLP	098 Slap Bass3	152 Trombone 1	206 Magic Bell	260 Syn Tom 2	314 ScratchDbI
045 F.Guitar	099 SynthBass1	153 Trombone 2	207 Sporing	261 VocalSnare	315 ScratDbI NT
046 F.GuitarLP	100 SynBass1LP	154 Trumpet	208 Rattle	262 Zap 1	316 Mini 1a
047 F.Guitar V	101 SynthBass2	155 Trumpet LP	209 Kava 1	263 Zap 2	317 Digital 1
048 A.Gtr Harm	102 SynBass2LP	156 Mute TP	210 Kava 2	264 Fret Zap 1	318 VS 102
049 E.Guitar 1	103 House Bass	157 Mute TP LP	211 Fever 1	265 Fret Zap 2	319 VS 48
050 E.Guitr1 V	104 FM Bass	158 Brass 1	212 Fever 2	266 Vibla Slap	320 VS 52
051 E.Guitar 2	105 FM Bass LP	159 Brass 1 LP	213 Zappers 1	267 Indust	321 VS 58
052 E.Guitar 3	106 Kalimba	160 Brass 2	214 Zappers 2	268 Thing	322 VS 71
053 MuteGuitar	107 Music Box	161 Brass 2 LP	215 Bugs	269 Thing NT	323 VS 72

324 VS 88	342 Organ 6 LP	360 Tin Flute	378 WaveSweepB	396 Boogeta	414 Pull 2 NT
325 VS 89	343 Super BX- 3	361 TinFluteLP	379 Lore	397 MouthHarp1	415 SolidHit
326 13 - 35	344 SuperBX3LP	362 BrightHorn	380 Lore NT	398 MouthHrp1A	416 HandDrill
327 DWGSOrgan1	345 Stick	363 Glass Vox	381 Tron Up	399 MouthHarp2	417 HandDriiNT
328 DWGSOrgan2	346 Tambura	364 Synth Pad	382 Tron Up LP	400 MouthHrp2A	418 Scratch a
329 DWGS E.P.	347 Tambura LP	365 Synth PadA	383 Tron Up NT	401 ChromRes	419 Samurai!
330 Saw	348 SynthBass3	366 Ghostly	384 Flute FX	402 WahFuzz	420 Growl!
331 Square	349 RezBass 1	367 WhiteNoise	385 FluteFX LP	403 OilDrum	421 Growl! NT
332 Ramp	350 RezBass 2	368 WhiteNoiNT	386 Flutter	404 Fist	422 Monkey 1
333 Pulse 25%	351 MiniBass	369 Jetstar	387 Flutter LP	405 Stick Hit	423 Monkey 2
334 Pulse 8%	352 SynMallet	370 Jetstar LP	388 Cast Roll	406 Metal Hit	424 MouthHarps
335 Pulse 4%	353 Glocken 2	371 JetstrLPNT	389 CastRollINT	407 GlassBreak	425 Loopey
336 Syn Sine	354 FingCymbal	372 Windbell	390 Harp Up	408 Baya	426 ClockWorks (P)
337 Sine	355 FingCymbNT	373 WindbellLP	391 Harp Up LP	409 Drop	427 MusicaLoop (P)
338 DJ Kit 1	356 Gong	374 WindbellNT	392 Jung Gliss	410 CorkPop	428 Manimals (P)
339 DJ Kit 2	357 Gong LP	375 Waterphone	393 JungGlisLP	411 Pull 1	429 Down Lo (P)
340 M1 Piano	358 HardFlute1	376 WaveSweep	394 MalletLoop	412 Pull 1 NT	
341 Organ 6	359 HardFlute2	377 WaveSweepA	395 MalletLpNT	413 Pull 2	(P) : with Pan

Drum Sound Name (164-214 X5D only)

000 Fat Kick	036 Side Stick	072 Slap Conga	108 FingerSnap	144 Stadium	180 Sword
001 Rock Kick	037 Syn Rim	073 Palm Conga	109 Timbales	145 BrushNoise	181 BISS
002 Ambi.Kick	038 VocalSnr 1	074 Mute Conga	110 Kalimba 1	146 Gt Slide	182 BOOFN
003 Crisp Kick	039 VocalSnr 2	075 Baya 1	111 Kalimba 2	147 Bell Tree	183 BOOGETA
004 Punch Kick	040 Crash Cym	076 Baya 2	112 Marimba 1	148 Tri Roll	184 CHLACK
005 Real Kick	041 Crash LP	077 Tabla 1	113 Marimba 2	149 JingleBell	185 COOSH
006 Dance Kick	042 China Cym	078 Tabla 2	114 Marimba 3	150 Whistle S	186 COUGH
007 Gated Kik	043 China LP	079 Tabla 3	115 Marimba 4	151 Whistle L	187 ISSH
008 ProcesKick	044 Splash Cym	080 Maracas	116 Xylofon 1	152 Timpani	188 POOM
009 Metal Kick	045 Splash LP	081 Cabasa	117 Xylofon 2	153 Taiko Hi	189 Uhhh!
010 Syn Kick 1	046 Orch Crash	082 SynMaracas	118 Xylofon 3	154 Taiko Lo	190 Samurai!
011 Syn Kick 2	047 OrchCym LP	083 MuteTriang	119 Log Drum 1	155 Music Box1	191 Growl!
012 Syn Kick 3	048 Tite HH	084 OpenTriang	120 Log Drum 2	156 Music Box2	192 Monkey 1
013 Orch B.Drm	049 Open HH	085 Tambourine	121 Log Drum 3	157 Clicker 1	193 Monkey 2
014 Snare 1	050 Pedal HH	086 Cowbell	122 Log Drum 4	158 Clicker 2	194 Glocken 2
015 Snare 2	051 CloseSynHH	087 SynCowbell	123 Log Drum 5	159 Clicker 3	195 Glocken 3
016 Snare 3	052 Open SynHH	088 R - Timbal	124 Snap	160 Crickets	196 FingCymbal
017 Snare 4	053 Sagat	089 Hi Timbal	125 BrightBell	161 Orch Hit	197 Gong Hi
018 PicloSnare	054 Ride Edge	090 Lo Timbal	126 Metal Bell	162 Metronome1	198 Gong Lo
019 Soft Snare	055 Ride Cup	091 WoodBlock1	127 Gamelan 1	163 Metronome2	199 WhiteNoise
020 LightSnare	056 Ride Cym 1	092 WoodBlock2	128 Gamelan 2	164 OilDrum	200 Jetstar
021 TightSnare	057 Ride Cym 2	093 WoodBlock3	129 Celeste	165 Fist	201 Windbell
022 Ambi.Snare	058 Tom Hi	094 Hand Claps	130 Glocken	166 Close HH	202 Waterphone
023 Rev Snare	059 Tom Lo	095 Syn Claps	131 Vibe 1	167 Stick Hit	203 Lore
024 RollSnare1	060 ProcessTom	096 Zap 1	132 Vibe 2	168 MetalHitHi	204 Tron Up
025 RollSnare2	061 SynTom1 Hi	097 Zap 2	133 Vibe 3	169 MetalHitLo	205 Flute FX
026 Rock Snare	062 SynTom1 Lo	098 Scratch Hi	134 Vibe 4	170 GlassBreak	206 Flutter
027 GatedSnare	063 Syn Tom 2	099 Scratch Lo	135 Pole	171 Drop	207 Cast Roll
028 PowerSnare	064 Brush Tom	100 ScratchDbl	136 TubulBell1	172 CorkPop	208 Harp Up
029 Syn Snare1	065 Agogo	101 Thing	137 TubulBell2	173 Pull 1	209 Jung Gliss
030 Syn Snare2	066 Lo Bongo	102 Mute Cuica	138 TubulBell3	174 Pull 2	210 MalletLoop
031 Gun Shot	067 Hi Bongo	103 Open Cuica	139 Gt Scratch	175 SolidHit	211 MouthHarp1
032 Brush Slap	068 Slap Bongo	104 Vibraslap	140 Chic 1	176 HandDrill	212 MouthHrp1A
033 BrushSwish	069 Claves	105 Guiro S	141 Chic 2	177 Scratch a	213 MouthHarp2
034 BrushSwirl	070 Syn Claves	106 Guiro L	142 Spectrum 1	178 Scratch b	214 MouthHrp2
035 Brush Tap	071 Open Conga	107 Castanet	143 Spectrum 2	179 Scratch c	

INDEX

A

After KBD	34, 147
After Touch	27, 162
Curve	149
Filter, Combination	101
Filter, Global	153
Filter, Multi	109
Modulation Intensity	88
Pitch Bend	90
VDA Amplitude	90
VDF MG Intensity	90
VDF Cutoff Frequency	90
AI Square Synthesis System	i
amplifier	36
Apple Macintosh	10
Arabic, Scale	150
Assignable Pedal	26, 27, 161
Assignable Switch	20, 26, 27, 161
Auto Pan, Effect	133

B

[BANK] button	2, 67
Bank	14, 17
Bank Select	19, 163
Before TG	34, 148

C

Calibration	64, 162
Chorus-Delay, Effect	135
Chorus 1/2, Effect	124
Combination Edit	15, 46
COMBINATION Paramaters	93-104
Combination Play	15, 22
Combination Types	23
Computer Select	11, 149
Concert Hall, Effect	118
Control Change	163
Control Change Filter	
Combination	101
Global	154
Multi	109
Copy	
Combination	112
Drum Kit	160
Effects	117
Scale	150
Color Intensity	77, 81
Color Velocity	77, 81
Cross Delay, Effect	121
Crossover Chorus, Effect	125
Crossover Flanger, Effect	128

D

Damper, Assignable Switch	161
Damper Pedal Filter	
Combination	63,101
Multi	109
Data Dump	155
Data entry, Assignable Pedal	161
Default Settings in Multi Mode	31
Delay/Chorus, Effect	138
Delay/Distortion, Effect	140
Delay/Flanger, Effect	139
Delay/Hall Reverb, Effect	137
Delay/Overdrive, Effect	140
Delay/Phaser, Effect	141
Delay/Room Reverb, Effect	137
Delay/Rotary Speaker, Effect	142
Delay Start, Program	73
Demo Song	13
Detune	
Combination	99
Multi	108
Program	73
Distortion, Effect	130
DOUBLE, OSC	42, 70
Drum Kit	21, 48, 158-160
Index	158
Copy	160
Drum Kit1 Setup	158
Drum Kit2 Setup	160
DRUMS, OSC	70
Drum Sound	48, 158
Dry Plate, Effect	119
Dual Mono Delay, Effect	122
Dynamic modulation control source	114

E

Early Reflection 1/2/3, Effect	120
Editing	35
[EDIT] button	2, 67
Effects	
Combination	104
Multi	111
Program	92
Effect 1/2, Assignable Switch	161
Effect Dynamic Modulation	27
Effect Placement	115
Effect Types	118-142
Effect Paramaters	113-145
EG	36
Enhancer, Effect	129
Ensemble Hall, Effect	118
Equal Temperament, Scale	150
Equal Temperament2, Scale	150
Error Messages	167
Exciter, Effect	129

Expression	31, 107
Expression, Assignable Pedal	161
External Out Select	11, 153

F

filter	35
Franger 1/2, Effect	128
Franger-Delay, Effect	135

G

GLOBAL	16
GLOBAL MIDI Channel	152
GLOBAL Paramaters	146-162
GM (General MIDI System Level 1)	ii, 16, 30-32, 66
Group Assign, Drum Kit	159

H

Harmonic Chorus, Effect	126
Hall, Effect	118
Hold, Program	70

I

IBM PC (Compatible)	9
Index, Drum Kit	158
Interval, OSC2	73

J

Joystick	
Modulation Intensity	88
VDF MG Intensity	90
VDF Sweep Intensity	91
Pitch Bend Range	91

K

Keyboard Input	67
Keyboard Sync	
VDF Modulation	89
Pitch1 Modulation	87
Keyboard Tracking	
Amplitude	85, 86
EG Time, VDF	80, 81
EG Time, VDA	85, 86
Intensity, VDF	80, 81
Key, VDA	84, 86
Key, VDF	79, 81
Modes, VDA	84, 86
Modes, VDF	79, 81
Keyboard Velocity	26
Key Window Top & Bottom	
Combination	47, 97
Multi	110
Kirnberger, Scale	150
KORG MIDI Driver	9, 10, 181-186

L

Large Room, Effect	118
Layer	23

Level

Combination	95
Multi	107
Program	71
Live Stage, Effect	119
Local Control	8, 153

M

main Scale	64
Master Tune	147
Memory Protect	154
MG	36
MG Wheel Calibration Set	162
MG Wheel Select	162
MIDI Data Format	169
MIDI Controller Filter	154
MIDI Connectors	7
MIDI Channel	
Global	152
Combination	96
Multi	111
MIDI Data Dump	155
MIDI Filter	
Global	24, 152
Combination	100
Multi	32, 109
MIDI Implementation Chart	188
MIDI System Exclusive Filter	154
Multi	16, 28
MULTI Setup Paramaters	105-112
Multisound	i, 41, 71, 73
Multi-Tap Delay 1/2/3, Effect	123
multi-timbre	28

N

No Effect	118
Note Receive Filter	152
NT (No Transpose)	71
Number Keypad	1

O

Octave, Program	71
Options	167
OSC (Oscillator)	35, 42, 54, 70-73
Oscillator mode	70
Overdrive, Effect	130

P

Page Memory	67, 154
Pan (Panpot)	41
Combination	102
Drum Kit	159
Multi	107
Program	71-73

Pan 3/4, Effect	115
Parallel 1/2/3 Placement	116
Parametric EQ, Effect	134
Pelag, Scale	150
Performance Technique	26
Pitch Bend	
Wheel	26, 162
Wheel Calibration Set	162
Range, Multi	108
Pitch EG	74
Pitch1 Modulation	86
Pitch2 Modulation	88
Placement	115
Polarity	161
Positional Crossfade	85
Preset Data Load	156
Program Change	19, 164
Program Change Filter	
Combination	100
Global	153
Multi	109
Program Down	20, 22, 161
PROGRAM EDIT	14, 37
PROGRAM PLAY	14, 17
PROGRAM Parameters	69-92
Program Select, Combination	94
Program Up	20, 22, 161
Pure Major, Scale	150
Pure Minor, Scale	150
Pythagorean, Scale	150
Q	
Quadrature Chorus, Effect	125
R	
Rename	
Combination	104
Program	92
Room, Effect	118
Rotary Speaker, Effect	132
RPN	163
S	
Scale	
Key	151
Sub	64, 151
Type	151
User	151
Scale Switch, Assignable Switch	161
Send C/D	
Combination	103
Drum Kit	159
Multi	107
Program	72
Serial Placement	115
Setting Up	5-11
SINGLE, OSC	70

Slendro, Scale	150
Specifications	167
Stereo Delay, Effect	121
Stereo Phaser 1/2, Effect	131
Spring Reverb, Effect	119
Split	23, 63
Symphonic Ensemble, Effect	127

T

Timber	15, 22
TO HOST	9, 10, 34, 149, 153, 155
Track	28
Transpose	
Combination	99
Global	147
Multi	108
Tremolo, Effect	133
Troubleshooting	166
Tuning	62, 147

U

Undo	1, 38, 67
User Scale	151

V

VDA	36
VDA1 EG	82
VDA1 Velocity Sensitivity	83
VDA2 EG	86
VDA2 Velocity Sensitivity	86
VDF	35
VDF Modulation	89
VDF1 Cutoff Frequency	76
VDF1 Velocity Sensitivity	78
VDF2 Cutoff	81
VDF2 Velocity Sensitivity	81
VDF EG	77
VDF cutoff, Assignable Pedal	161
Velocity Curve	148
Velocity Sensitivity EG Time	79
Velocity Sensitivity EG Intensity	78
Velocity Switch	23
Velocity Window Top & Bottom	
Combination	98
Multi	110
Volume, Assignable Pedal	161

W

Werkmeister, Scale	150
Wet Plate, Effect	119
Write	
Combination	104
Program	92

O

05R/W	65, 155
-------------	---------

NOTICE

KORG products are manufactured under strict specifications and voltages required by each country. These products are warranted by the KORG distributor only in each country. Any KORG product not sold with a warranty card or carrying a serial number disqualifies the product sold from the manufacturer's/distributor's warranty and liability. This requirement is for your own protection and safety.

KORG KORG INC.

15 - 12, Shimotakaido 1 - chome, Suginami-ku, Tokyo, Japan.