

N264/N364

MUSIC WORKSTATION

Basic Guide

GENERAL
MIDI
INSTRUMENT

Please read this guide first

 AI² Synthesis System

KORG

IMPORTANT SAFETY INSTRUCTIONS

WARNING — When using electrical products, basic precautions should be followed, including the following:

1. Read all the instructions before using the product.
2. Do not use this product near water — for example, near a bathtub, washbowl, kitchen sink, in a wet basement, or near a swimming pool, or the like.
3. This product should be used only with the cart or stand that is recommended by the manufacturer.
4. This product, either alone or in combination with an amplifier and headphones or speakers, may be capable of producing sound levels that could cause permanent hearing loss. Do not operate for a long period of time at a high volume level or at a level that is uncomfortable. If you experience any hearing loss or ringing in the ears, you should consult an audiologist.
5. The product should be located so that its location or position does not interfere with its proper ventilation.
6. The product should be located away from heat sources such as radiators, heat registers, or other products that produce heat.
7. The product should be connected to a power supply of the type described in the operating instructions or as marked on the product.
8. The power-supply cord of the product should be unplugged from the outlet when left unused for a long period of time.
9. Care should be taken so that objects do not fall and liquids are not spilled into the enclosure through openings.
10. The product should be serviced by qualified personnel when:
 - A. The power-supply cord or the plug has been damaged; or
 - B. Objects have fallen, or liquid has been spilled into the product; or
 - C. The product has been exposed to rain; or
 - D. The product does not appear to operate normally or exhibits a marked change in performance; or
 - E. The product has been dropped, or the enclosure damaged.
11. Do not attempt to service the product beyond that described in the user-maintenance instructions. All other servicing should be referred to qualified service personnel.

SAVE THESE INSTRUCTIONS

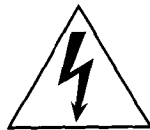
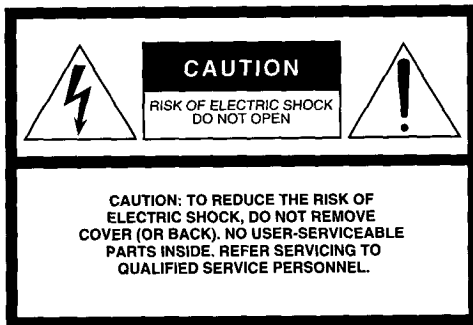

The lightning flash with the arrowhead symbol within an equilateral triangle, is intended to alert the user to the presence of uninsulated “dangerous voltage” within the product’s enclosure that may be of sufficient magnitude to constitute a risk of electric shock to persons.



The exclamation point within an equilateral triangle is intended to alert the user to the presence of important operating and maintenance (servicing) instructions in the literature accompanying the product.

GROUNDING INSTRUCTIONS

This product must be grounded (earthed). If it should malfunction or breakdown, grounding provides a path of least resistance for electric current to reduce the risk of electric shock. This product is equipped with a cord having an equipment-grounding conductor and a grounding plug. The plug must be plugged into an appropriate outlet that is properly installed and grounded in accordance with the local codes and ordinances.

DANGER – Improper connection of the equipment-grounding conductor can result in a risk of electric shock. Check with a qualified electrician or serviceman if you are in doubt as to whether the product is properly grounded. Do not modify the plug provided with the product – if it will not fit the outlet, have a proper outlet installed by a qualified electrician.

THE FCC REGULATION WARNING

This equipment has been tested and found to comply with the limits for a Class B digital device, pursuant to Part 15 of the FCC Rules. These limits are designed to provide reasonable protection against harmful interference in a residential installation. This equipment generates, uses, and can radiate radio frequency energy and, if not installed and used in accordance with the instructions, may cause harmful interference to radio communications. However, there is no guarantee that interference will not occur in a particular installation. If this equipment does cause harmful interference to radio or television reception, which can be determined by turning the equipment off and on, the user is encouraged to try to correct the interference by one or more of the following measures:

- Reorient or relocate the receiving antenna.
- Increase the separation between the equipment and receiver.
- Connect the equipment into an outlet on a circuit different from that to which the receiver is connected.
- Consult the dealer or an experienced radio/TV technician for help.

CANADA

THIS APPARATUS DOES NOT EXCEED THE "CLASS B" LIMITS FOR RADIO NOISE EMISSIONS FROM DIGITAL APPARATUS SET OUT IN THE RADIO INTERFERENCE REGULATION OF THE CANADIAN DEPARTMENT OF COMMUNICATIONS.

LE PRESENT APPAREIL NUMERIQUE N'EMET PAS DE BRUITS RADIOELECTRIQUES DEPASSANT LES LIMITES APPLICABLES AUX APPAREILS NUMERIQUES DE LA "CLASSE B" PRESCRITES DANS LE REGLEMENT SUR LE BROUILLAGE RADIOELECTRIQUE EDICTE PAR LE MINISTERE DES COMMUNICATIONS DU CANADA.

CE mark for European Harmonized Standards

CE mark which is attached to our company's products of AC mains operated apparatus until December 31, 1996 means it conforms to EMC Directive (89/336/EEC) and CE mark Directive (93/68/EEC).

And, CE mark which is attached after January 1, 1997 means it conforms to EMC Directive (89/336/EEC), CE mark Directive (93/68/EEC) and Low Voltage Directive (73/23/EEC).

Also, CE mark which is attached to our company's products of Battery operated apparatus means it conforms to EMC Directive (89/336/EEC) and CE mark Directive (93/68/EEC).

IMPORTANT NOTICE FOR THE UNITED KINGDOM

Warning-THIS APPARATUS MUST BE EARTHED

As the colours of the wires in the mains lead of this apparatus may not correspond with the coloured markings identifying the terminals in your plug, proceed as follows:

- the wire which is coloured green and yellow must be connected to the terminal in the plug which is marked with the letter E or by the earth symbol , or coloured green or green and yellow.
- the wire which is coloured blue must be connected to the terminal which is marked with the letter N or coloured black.
- the wire which is coloured brown must be connected to the terminal which is marked with the letter L or coloured red.

Back-up Battery

The N264/N364 uses a back-up battery to prevent memory loss when the power is turned off. If the display shows "Battery Low", the battery should be replaced. Consult the nearest Korg Service Center or dealer.

Data Handling

Data in memory may sometimes be lost due to incorrect user action. Be sure to save important data to floppy disk.

Korg will not be responsible for damages caused by data loss.

LCD Display

Some pages of the manuals show LCD screens along with an explanation of functions and operations. All sound names, parameter names, and values are merely examples and may not always match the actual display you are working on.

Trademarks

MS-DOS is a registered trademark of Microsoft Corporation.

All trademarks or registered trademarks are the property of their respective holders.

Table of Contents

Introduction	1
Welcome to the N264/N364	1
Unpacking Your N264/N364	1
N264/N364 Manuals	1
What is the N264/N364?	2
N264/N364 Architecture	2
Sequencer	3
Digital Multi-Effects Processors	3
Arpeggio Mode	3
Realtime Pattern Play/Recording (RPPR) Mode	3
Floppy Disk Drive	3
General MIDI	3
SMF (Standard MIDI Files)	4
N264/N364 Memory Banks	4
Output Routing	4
N264/N364 Modes	5
Chapter 1: Controls & Connections	6
Front Panel	6
Rear Panel	11
Chapter 2: Setting Up the N264/N364	13
Connecting Audio Equipment	13
Power On Procedure	14
LCD Contrast	14
Listening to the Demo Songs	14
Listening to the Realtime Pattern Play demo	14
Using Arpeggio mode	15
MIDI Connections	15
Chapter 3: Getting Around the N264/N364	18
The LCD	18
Selecting LCD Screens	20
Selecting Parameters	20
Setting Parameters	21
Comparing While Editing	21
Useful Notes	21
MIDI Notes	22
Chapter 4: Program Play Tutorial	23
Changing the N264/N364 Global MIDI Channel	23
Selecting Banks & Programs	24
Editing in Program Play Mode	25
Chapter 5: Combination Play Tutorial	26
Combination Structure	26
Playing Combinations	27
Timbre MIDI Channels	27
Selecting Banks & Combinations	28
Editing in Combination Play Mode	29

Chapter 6: Combination Edit Tutorial	30
Combination Types	30
Editing Combinations	31
Using the N264/N364 as a MultiTimbral Tone Generator	32
Saving Combinations	32
Chapter 7: Effects Tutorial	33
What is a Multi-Effects Processor?	33
Effect Types	33
Spatial Effects for the Sound Creation Process	34
Using the Effects	36
Chapter 8: Program Edit Tutorial	37
Three Sound Building Blocks	37
Volume Editing	37
Tone Editing	38
A Few Words about Pitch	39
What is Double Mode?	40
Programs with Effects	40
Saving Programs	40
Creating Original Sounds	40
Chapter 9: Using the N264/N364 Sequencer	41
Using the N264/N364 as Your Main Sequencer	41
Using the N264/N364 Sequencer as a Musical Sketch Pad	42
Chapter 10: Playing GM Songs	43
About GM Song Data	43
Chapter 11: Arpeggio mode	44
About Arpeggio mode	44
Editing in Arpeggio mode	45
Techniques for arpeggio playing	45
Recording arpeggio playing	46
Chapter 12: Realtime Pattern Play/Recording mode	47
About Realtime Pattern Play/Recording mode	47
Realtime Pattern Play playing techniques	48
Recording procedure	49
Playing techniques in Realtime Pattern Play/Recording	50
Chapter 13: Data Compatibility	52
Chapter 14: Voice Name List	53
MULTISOUND.....	53
DRUMSOUND.....	54
PROGRAM.....	55
COMBINATION.....	58
DRUMKIT.....	62
PATTERN	66
Demo Song	67
RPPR Demo.....	67
Files on the included disk	67

Introduction

Welcome to the N264/N364

Thank you for purchasing a Korg N264/N364 Music Workstation, and welcome to the exciting world of AI² Synthesis.

Unpacking Your N264/N364

The following items should be enclosed with your N264/N364. Make sure that you have them all.

- *Basic Guide*
- *Reference Guide*
- N264/N364 data floppy disk
- Power cable

Keep the packaging materials for when you want to transport the N264/N364 in the future.

N264/N364 Manuals

The N264/N364 is supplied with two user manuals: this *Basic Guide* and a *Reference Guide*.

This *Basic Guide* explains how to set up, switch on, and play the N264/N364. Using a tutorial style format, it also introduces some of the N264/N364 functions. Use this guide first, then when you want to know the full details, see the *Reference Guide*.

The *Reference Guide* contains full details about all the N264/N364's functions. It also contains an index that will help you to locate information quickly.

What is the N264/N364?

The following illustration shows the basic parts that make up the N264/N364 Music Workstation.

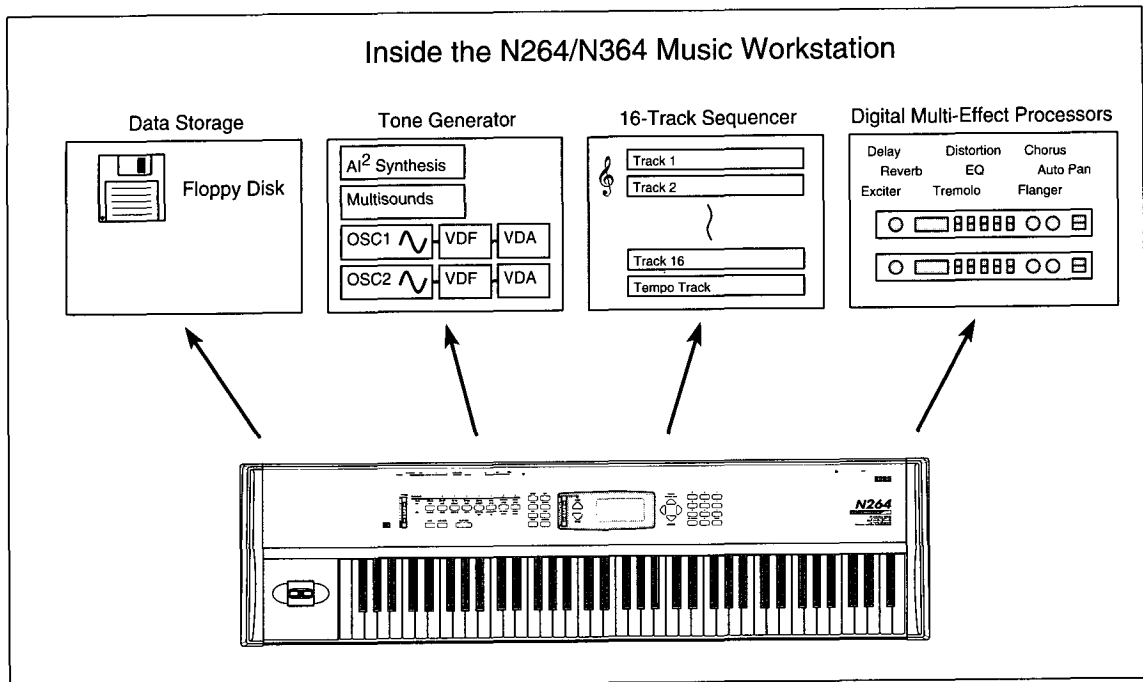

N264/N364 Architecture

AI² Synthesis Technology: This is technology developed by Korg that captures the true essence of acoustic sound for use in a tone generator.

Multisounds: These are the basic sound elements (PCM waveforms) from which Programs are created. The N264/N364 contains 430 Multisounds such as piano and organ. Together with the drum sounds, the internal Multisounds are stored inside the N264/N364 in 8 Mbytes of ROM.

Drum sounds: These are the sounds (PCM waveforms) from which Drum Programs are created. The N264/N364 contains 215 drum sounds, such as hi-hat and snare drum.

Drum kits: Each drum kit contains 60 “indexes”, with one drum sound assigned to each index. For each index, you can specify the note that will play it, and the volume etc. The N264/N364 contains 4 user kits (Drum Kit A1, A2, B1, B2) which allow you to create your own original drum kits, and 12 ROM kits (Drum Kit C1, C2, D1, D2, ROM D.Kit 1–8) in which the key assignments are fixed.

Programs: The N264/N364 has three types of programs; Single mode and Drum mode programs in which one oscillator is used to produce each note, and Double mode programs which use two oscillators to produce each note. Single mode and Double mode programs assign a multisound to their oscillator, and Drum mode programs assign a drum kit to their oscillator. Double mode programs have independent VDA (Variable Digital Amplifier), VDF (Variable Digital Filter), Pitch MG, VDF EG, and VDA EG for each oscillator. (The Pitch EG and VDF MG are shared by both oscillators.) The audio signals from the program are sent from the four outputs (A, B, C, D) as specified for each oscillator and sent to multi-effects 1 and 2.

The N264/N364 contains a total of 536 programs (100 each in banks A, B, C, and D, and 136 in bank GM).

Combinations: Each Combination contains eight Timbres (“instruments”), and each Timbre is assigned a Program and MIDI channel, etc. Combinations allow you to play two or more programs “layered,” or to play multi-timbred sequences. By assigning Timbres to different areas of the keyboard, you can create split-type Combinations. By specifying the range of note velocities which will play each Timbre, you can create velocity-switched Combinations. The audio signal from the Combination is sent from four outputs (A, B, C, D) as specified for each Timbre, and sent to multi-effects 1 and 2.

The N264/N364 has a total of 400 Combinations (100 each in banks A, B, C, D).

Sequencer

The N264/N364 contains a 16-track sequencer that has a maximum event capacity of 32,000. Up to 10 songs and 100 patterns can be held in memory simultaneously. Up to 999 measures can be contained. Each track is assigned a Program, MIDI Channel, etc. A tempo track is provided for entering tempo changes. Tracks and patterns can be recorded in real time and step time. Patterns can also be created by copying a specified section of a track. Patterns can be copied or put into tracks. EXT mode tracks can be used to control other MIDI instruments.

Songs are output on four buses (A, B, C, D) that feed multi-effects 1 and 2.

Digital Multi-Effects Processors

The N264/N364 contains two digital multi-effects processors that can produce 47 effects such as reverb, delay, chorus, flanger, distortion, EQ, auto pan, exciter, etc. Effects 1 to 37 are single effects, 38 and 39 are serial effects, and 40 to 47 are parallel effects. The parallel type effects allow up to four independent effects simultaneously.

Each Program, Combination, and song can have its own effect settings. When a Program is used as part of a Combination or song, its own effects settings are ignored, and effects settings for that particular Combination or song are used.

Arpeggio Mode

This mode lets you produce automatic arpeggios simply by holding down keys. Five types of arpeggio are provided: UP, DOWN, ALT1, ALT2, and RANDOM. The OCTAVE parameter lets you select the pitch range in which the arpeggio will sound: 1, 2, 3 or 4 octaves. Additional parameters such as SORT, GATE, and SYNC allow you to create a variety of different styles of arpeggio performance.

Realtime Pattern Play/Recording (RPPR) Mode

This mode allows you to assign a sequencer pattern to a specified key of the keyboard, and then play or record pattern data by pressing that key. Patterns can be assigned to the 60 keys from C#2 to C7, and ten different sets of these 60 patterns can be stored. You can play a different phrase from each key, or play several keys simultaneously so that different phrases are played back simultaneously.

Floppy Disk Drive

An internal 3.5 inch 2DD, 2HD floppy disk drive provides a convenient way to store your Programs, Combinations, sequencer songs, and patterns. In addition, MIDI Exclusive data from other MIDI devices can be stored and loaded via the disk drive, just like a MIDI data filer. The N264/N364 floppy disk format is compatible with the MS-DOS 720KB and 1.44MB disk format, making it easy to exchange SMF (Standard MIDI File) data with other users.

General MIDI

GM (General MIDI) is a MIDI Standard implemented by a number of manufacturers. Among other things, it states that a GM compatible tone generator must have 128 specific programs, be able to produce at least 24 notes simultaneously, and use MIDI Channel 10 for drums and percussion. The main reason for GM is to improve song data compatibility between different music systems.

Since Sequencer mode allows you to record/playback GM-compatible songs, musical data created on the N264/N364 can be easily played back on other GM-compatible instruments.

The GM standard does not specify effect types, tone generator architecture, or sound generation processes, so song files produced using other tone generators will not sound exactly the same on the N264/N364. If you are depending on GM compatibility, create a few sample song files to check compatibility with the system that you hope to exchange data.

See "Playing GM Songs" on page 43 for more details.

SMF (Standard MIDI Files)

SMF allows you to transfer song data between sequencing systems. It is a standard format for sequence data. Most recent software and hardware sequencers support SMF.

SMF files come in three formats: Format 0, Format 1, and Format 2. The N264/N364 supports formats 0 and 1. In format 0, data of all tracks is merged onto one track and saved to floppy disk. In format 1, data is saved on individual tracks. Format 1 is more common.

SMF data does not necessarily conform to the GM standard, however, SMF is a useful way of transferring song data between GM compatible music systems.

Note: *GS and XG are standards which are similar to GM and have similar operation, but please be aware that musical data created for GS or XG may not playback correctly on a GM-compatible tone generator.*

N264/N364 Memory Banks

The following table shows how the N264/N364 memory banks are organized.

Bank A	Bank B	Bank C (ROM)	Bank D (ROM)	Bank GM (ROM)
100 Programs	100 Programs	100 Programs	100 Programs	136 Programs
100 Combinations	100 Combinations	100 Combinations	100 Combinations	—
Drum kits A1 and A2	Drum kits B1 and B2	Drum kits C1 and C2	Drum kits D1 and D2	ROM Drum kits 1–8
Global setup data				

In addition to these memories, internal RAM contains sequence data (a maximum of 32,000 events in 10 songs and 100 patterns). ROM banks are read-only. It is not possible to store (write) edited program data into a ROM bank. (ROM: Read Only Memory.)

Output Routing

The following illustration shows how Programs, Combinations, and songs are output. Pan, Send C, and Send D parameters can be set individually for each Program oscillator, Combination Timbre, and song track. The four output buses A, B, C, and D are fed to the two multi-effects processors, and mixed down and output from 1/L/MONO, 2/R, 3 and 4. The N264/N364 allows the two effects processors to be connected in six ways, called Effect Placements. (See “7E Effect Placement” on page 59 of the *Reference Guide*.)

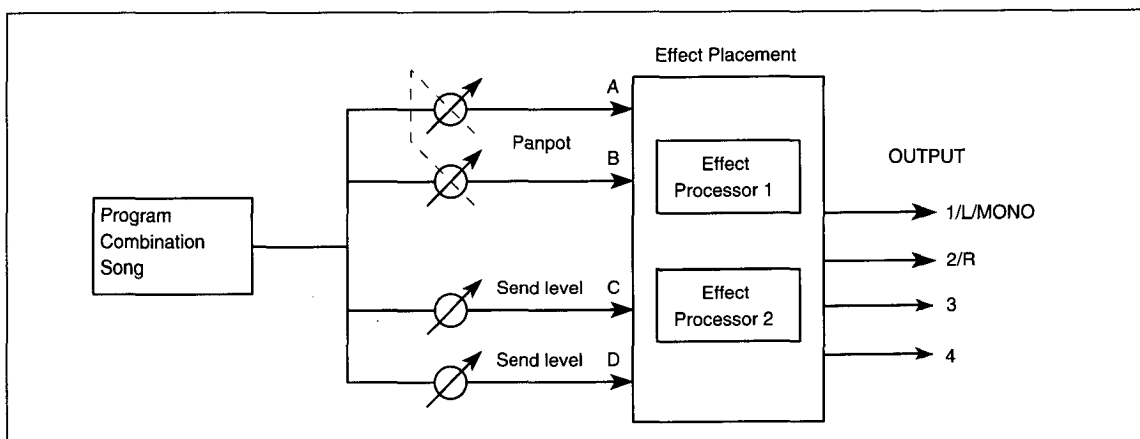

N264/N364 Modes

The following table lists the N264/N364 operating modes and gives a brief explanation of what you can do in each mode.

Mode	What You Can Do
Program Play mode	Play and select Programs, edit some parameters.
Program Edit mode	Edit all Program parameters, set up Program effects, write Programs to memory.
Combination Play mode	Play and select Combinations, edit some parameters.
Combination Edit mode	Edit all Combination parameters, set up Combination effects, write Combinations to memory.
Sequencer mode	Play back songs and record in real time.
Sequencer Edit mode	Record in step time, record patterns in real time and step time, set up song effects, edit tracks, patterns, etc.
Global mode	Set parameters that change the overall performance of the N264/N364 such as the Global MIDI Channel, master tune, transpose, MIDI filters, memory protection, set up the drum kits, assignable pedal, etc.
Disk mode	Save and load N264/N364 data to floppy disk, save and load MIDI Exclusive data, save and load SMF (Standard MIDI Files), delete disk files, rename disk files, etc.
Arpeggio mode	Play and set parameters for the arpeggios that will be available in Program Play, Combination Play, and Sequencer mode.
Realtime Pattern Play/Recording mode (RPPR mode)	Set record, play, and pattern set parameters for Realtime Pattern Play/Recording.

Chapter 1: Controls & Connections

Front Panel

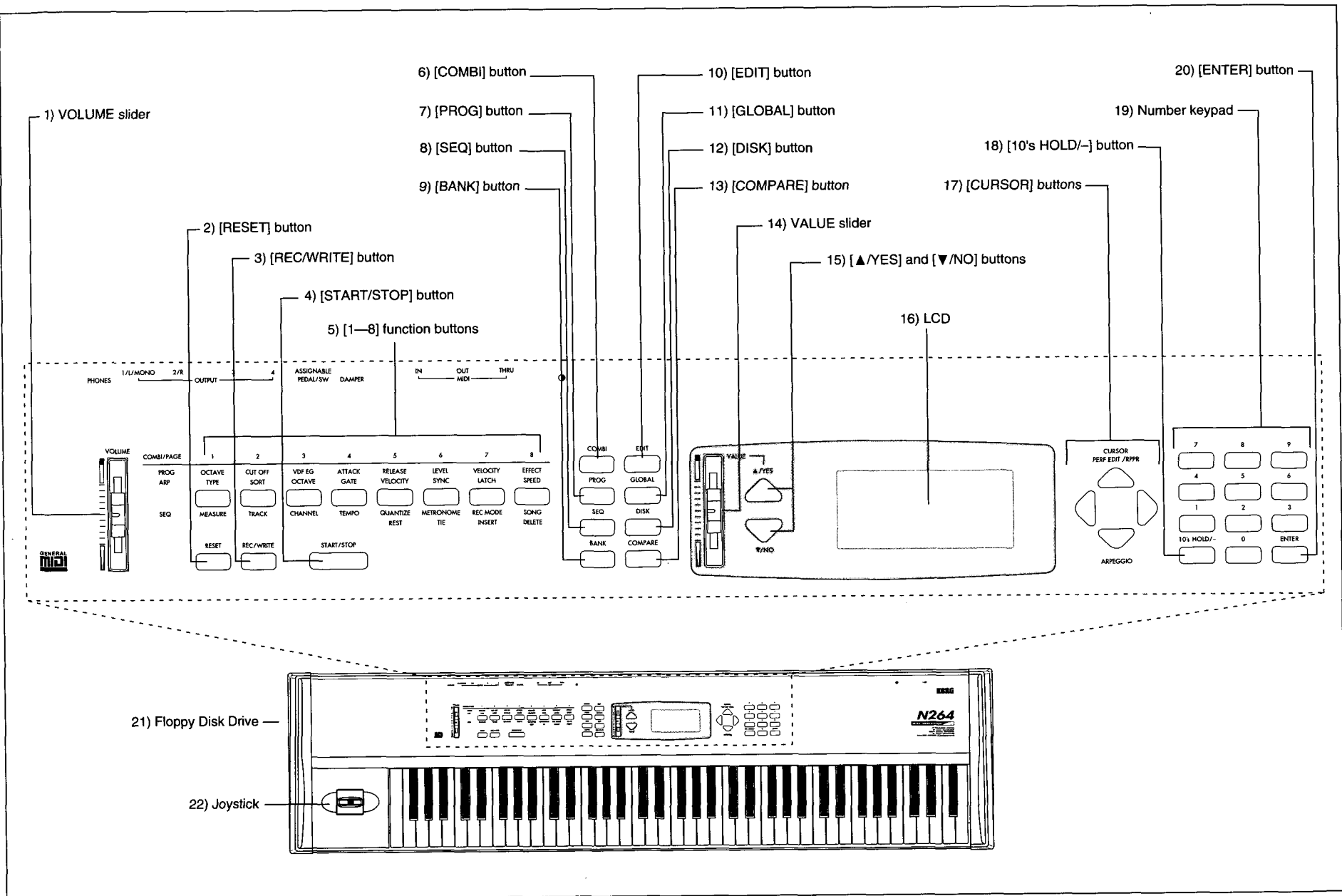

1) VOLUME slider

This slider adjusts the output volume of the N264/N364. It also controls the headphone volume.

2) [RESET] button

This button works in Sequencer mode and Sequencer Edit mode. When the sequencer is stopped, pressing this button will return the song to the beginning. If, for some reason, the sound being produced cannot be stopped, press this button.

3) [REC/WRITE] button

The operation of this button depends on the selected mode:

Sequencer and Sequencer Edit Modes: pressing this button will engage Record Ready mode, and REC will appear on the LCD screen. To cancel Record Ready mode, press again. To start recording, press the [START/STOP] button.

Program Play, Program Edit, Combination Play, Combination Edit modes: pressing this button allows you to write the current Program or Combination to memory.

4) [START/STOP] button

This button works in Sequencer mode and Sequencer Edit mode. It is used to start and stop song playback and recording.

5) [1–8] function buttons

The operation of these buttons depends on the current mode, as explained in the following table. The names of the functions that these buttons perform are printed on the N264/N364 in different colors. The table also lists how colors correspond to modes.

Current Mode	Operation
Program Play Mode	Select the various parameters that can be edited in Program Play mode. See "Editing in Program Play Mode (Performance Editing)" on page 5 of the <i>Reference Guide</i> . White text on front panel.
Program Edit Mode	Select LCD screen groups for parameters and functions in Program Edit mode. See "Program Edit Mode" on page 7 of the <i>Reference Guide</i> .
Combination Play Mode	Select a Timbre from 1 to 8 for editing in Combination Play mode. See "Editing in Combination Play Mode (Performance Editing)" on page 37 of the <i>Reference Guide</i> . Blue text on front panel.
	Individual Timbres can be soloed by double clicking on the corresponding button. See "Soloing Individual Timbres" on page 38 of the <i>Reference Guide</i> .
Combination Edit Mode	Select LCD screen groups for parameters and functions in Combination Edit mode. See "Combination Edit Mode" on page 39 of the <i>Reference Guide</i> .
Sequencer Mode	Select the various parameters for playing and recording songs. See "Sequencer Mode" on page 93 of the <i>Reference Guide</i> . Green text on front panel.
	Function button 2 can be used to solo the currently selected track. See "Soloing Individual Tracks" on page 97 of the <i>Reference Guide</i> . Green text on front panel.
Sequencer Edit Mode	Select LCD screen groups for parameters and functions in Sequencer Edit mode. See "Sequencer Edit Mode" on page 113 of the <i>Reference Guide</i> .
	For step-time recording and event edit, function buttons 5, 6, 7, 8 are used to enter rests, ties, notes, and delete notes, respectively. Green text on front panel.
Global Mode	Select LCD screen groups for parameters and functions in Global mode. See "Global Mode" on page 165 of the <i>Reference Guide</i> .
Disk Mode	Select LCD screen groups for parameters and functions in Disk mode. See "Disk Mode" on page 181 of the <i>Reference Guide</i> .
Arpeggio Mode	Select patterns. See "Arpeggio mode" on page 155 of the <i>Reference Guide</i> . White text on front panel.

Powering on the N264/N364 while pressing the [SEQ] button and function button [8] will erase all sequencer data and initialize all parameters. Make sure that you save your important data to floppy disk beforehand. See "Erase All Sequencer Data" on page 98 of the *Reference Guide*.

6) [COMBI] button

Press this button to select Combination Play mode.

7) [PROG] button

Press this button to select Program Play mode.

8) [SEQ] button

Press this button to select Sequencer mode.

Powering on the N264/N364 while pressing the [SEQ] button and function button [8] will erase all sequencer data and initialize all parameters. Make sure that you save your important data to either floppy disk or card beforehand. See "Erase All Sequencer Data" on page 98 of the *Reference Guide*.

9) [BANK] button

In Program Play mode, press this button to select banks A, B, C, D or GM. In Combination Play mode, press this button to select banks A, B, C or D.

10) [EDIT] button

Press this button to enter the corresponding edit mode for the current mode. For example, to select Program Edit mode, first select Program Play mode by pressing the [PROG] button, then press the [EDIT] button; EDIT will appear on the LCD screen. To cancel an edit mode, press another mode button.

11) [GLOBAL] button

Press this button to select Global mode.

12) [DISK] button

Press this button to select Disk mode.

13) [COMPARE] button

Pressing this button while editing a Program, Combination or Song allows you to compare the Program, Combination or Song that you are currently editing with the original. (The display will indicate [COMPARE].) The data being edited is kept in memory. Press this button once again to return to the edited data. (The [COMPARE] indication will disappear.) Be aware that if you edit a parameter while the display indicates [COMPARE], the previously edited data will be lost.

14) VALUE slider

This slider is used to set parameter values and select parameter options. It can also be used to control effect parameters when set as the dynamic modulation control source.

15) [▲/YES] and [▼/NO] buttons

In Program Play mode and Combination Play mode, these buttons allow you to select Programs and Combinations, respectively.

These buttons can be used to set parameter values and select parameter options. Press the [▲/YES] button to increase values, and the [▼/NO] button to decrease them. Pressing and holding either button will change the selected parameter value rapidly.

By pressing both buttons simultaneously, you can reset the parameter to its original value, that is, the value before you edited it.

These buttons are also used when the N264/N364 requires a yes or no answer from you. For example, when the message "Are You Sure?" appears, press the [▲/YES] button to continue, or the [▼/NO] button to cancel.

16) LCD

This large, clear, and easy to read visual interface displays the current mode and any parameters related to that mode.

17) [CURSOR] buttons

These buttons are used to move the cursor around the LCD and select parameters.

To select an LCD screen, press and hold down the [←] or [→] cursor button. To select the next LCD screen to the left, press the [←] cursor button. To select the next LCD screen to the right, press the [→] button. To select the next or previous parameter group, use the [↑] and [↓] cursor buttons.

When another LCD screen is available to the left, "<" is shown. When another LCD screen is available to the right, ">" is shown. When LCD screens are available to both the left and right, "<>" is shown.

These buttons are also used to insert and delete characters when naming Programs, Combinations, and songs.

In Program Play, Combination Play, and Sequencer modes, you can use the [↑][↓] buttons to move to other modes.

Program Play mode: Press the [↑] button to move to Performance Edit.

Combination Play mode: Press the [↑] button to edit the major parameters of each Timbre.

Sequencer mode: Press the [↑] button to move to RPPR mode.

To return from these conditions to the original mode, press the [↓] button.

Also, when in Program Play, Combination Play, or Sequencer modes, you can press the [↓] button to move to Arpeggio mode.

18) [10's HOLD/-] button

In Program Play mode and Combination Play mode, this button allows you to select Programs and Combinations with just one button press. Pressing the [10's HOLD/-] button will display a dot between the right-two digits on the LCD. At this time, pressing the number keypad changes the unit's digit of the Program or Combination number. Pressing the [▲/YES] and [▼/NO] buttons changes the ten's digit. For example, if you have selected Program 21 and you want to select Program 29, first press the [10's HOLD/-] button, then press number button [9]. Program 29 will be selected. Alternatively, to select Program 31, just press the [▲/YES] button. Program 31 will be selected. To cancel the 10's HOLD function, press the [10's HOLD/-] button.

This button is also used to enter negative parameter values. To make a negative value positive or vice versa, press the [10's HOLD/-] button. See "Setting Parameters" on page 21.

In Combination Edit mode, you can use this button to select Program banks when setting up Timbres.

When naming Programs, Combinations, and songs, this button can be used to select lowercase and uppercase characters. See "8B Program Rename" on page 33, "8B Combination Rename" on page 55, and "8A Rename Song" on page 150 of the *Reference Guide*.

19) Number keypad

This keypad allows you to select Programs and Combinations by entering the corresponding number. For example, to select Program 67 (presuming you are in Program Play mode), press number button [6], then [7].

The keypad can also be used to specify parameter values. See "Setting Parameters" on page 21. And to insert and delete characters when naming Programs, Combinations, and songs.

20) [ENTER] button

When you specify a parameter value using the number keypad, press this button to enter that value. If you do not press this button, the specified value will not be entered.

This button is also used when specifying parameter values using the keyboard.

21) Floppy Disk Drive

This is where you insert 3.5 inch 2DD or 2HD type floppy disks. You can store Programs, Combinations, sequencer data, MIDI exclusive data, and SMF (Standard MIDI Files) on floppy disks. See "Disk Mode" on page 181 of the *Reference Guide*.

22) Joystick

The joystick allows real-time control of the following Program parameters: Pitch Bend, VDF Cutoff Frequency, VDF Modulation Intensity, Modulation Frequency and Intensity. See “5A Pitch1 Modulation” on page 27 and “6A After Touch & Joystick Control” on page 30 of the *Reference Guide*.

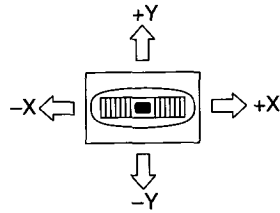

- ±X Pitch bend, VDF cutoff sweep
- +Y Pitch modulation depth (vibrato), speed
- Y VDF modulation depth (wow wow)

Rear Panel

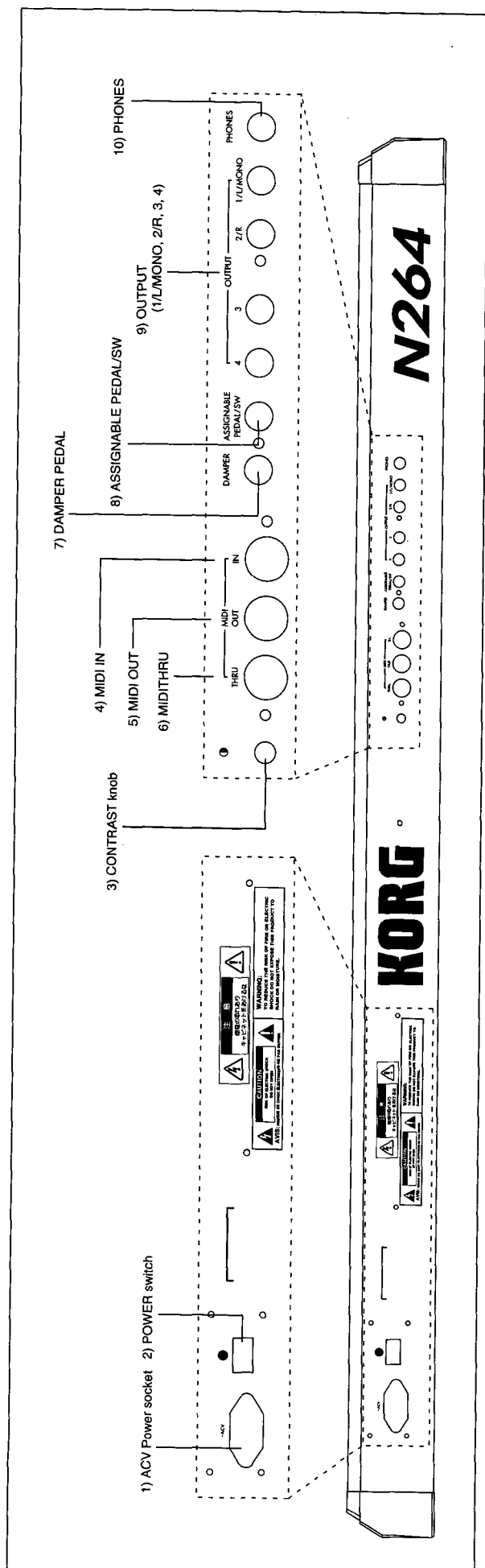
**1) ACV Power socket**

Connect the supplied power cord to this connection. Connect the other end of the power cord to a suitable AC receptacle.

2) POWER switch

This switch is used to power on and power off the N264/N364. Press once to power on; press again to power off.

3) CONTRAST knob

This knob is used to adjust the LCD contrast. The LCD contrast varies depending on the angle that you look at it. Turning the knob clockwise makes the contrast darker, while turning it counterclockwise makes it lighter.

4) MIDI IN

The N264/N364 receives MIDI data via this connection. This could be connected to the MIDI OUT of a master keyboard, external sequencer, guitar controller, etc.

5) MIDI OUT

The N264/N364 outputs MIDI data via this connection. This could be connected to the MIDI IN of a synthesizer, external sequencer, drum machine, etc.

6) MIDI THRU

This connection outputs MIDI data received at the MIDI IN connection. This allows you to connect a number of MIDI devices in a daisy chain. Each device receives all the MIDI data, but only responds to data on the specified MIDI Channel.

If you want to connect more than three MIDI devices, we recommended that you use an optional MIDI THRU box. See your Korg dealer for more details.

7) DAMPER PEDAL

An optional Korg Damper pedal can be connected here. See "7B Damper Pedal Polarity" on page 179 of the *Reference Guide*.

8) ASSIGNABLE PEDAL/SW

An optional Korg PS-1 or PS-2 foot switch or EXP-2 or XVP-10 foot controller can be connected here. A pedal connected here can be set to perform one of many functions, such as selecting Programs and Combinations, starting and stopping the sequencer, or controlling the volume. See "7A Assignable Pedal/SW Setup" on page 179 of the *Reference Guide*.

9) OUTPUT 1/L/MONO, 2/R, 3, 4

These 1/4 inch phone jack connections should be connected to the inputs of a stereo amplifier, mixer, or cassette multitracker. If your amplifier is mono, use the 1/L/MONO connection.

10) PHONES

A pair of stereo headphones can be connected here for private playing. The headphone signal is the same as that appearing at the 1/L/MONO and 2/R outputs. On the N264/N364, depending on the chosen effect placement, you may not be able to hear sounds that are routed through buses C and D.

Chapter 2: Setting Up the N264/N364

Connecting Audio Equipment

Before making any connections, make sure that each piece of equipment is powered off, and that all volume controls are set to minimum.

1) Using the N264/N364 as the Only Sound Source

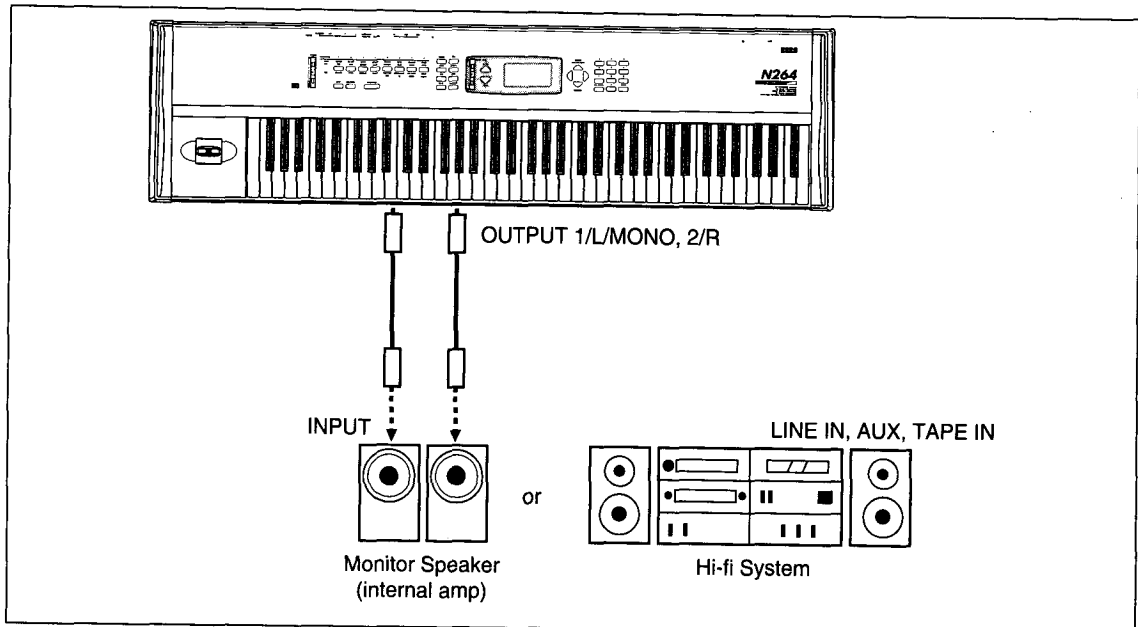

2) Using the N264/N364 in Combination with Other Sound Sources

When you use multiple tone generators, we recommend that you use a mixing console for easier operation. Some keyboard amplifiers have a few inputs for connecting a number of devices.

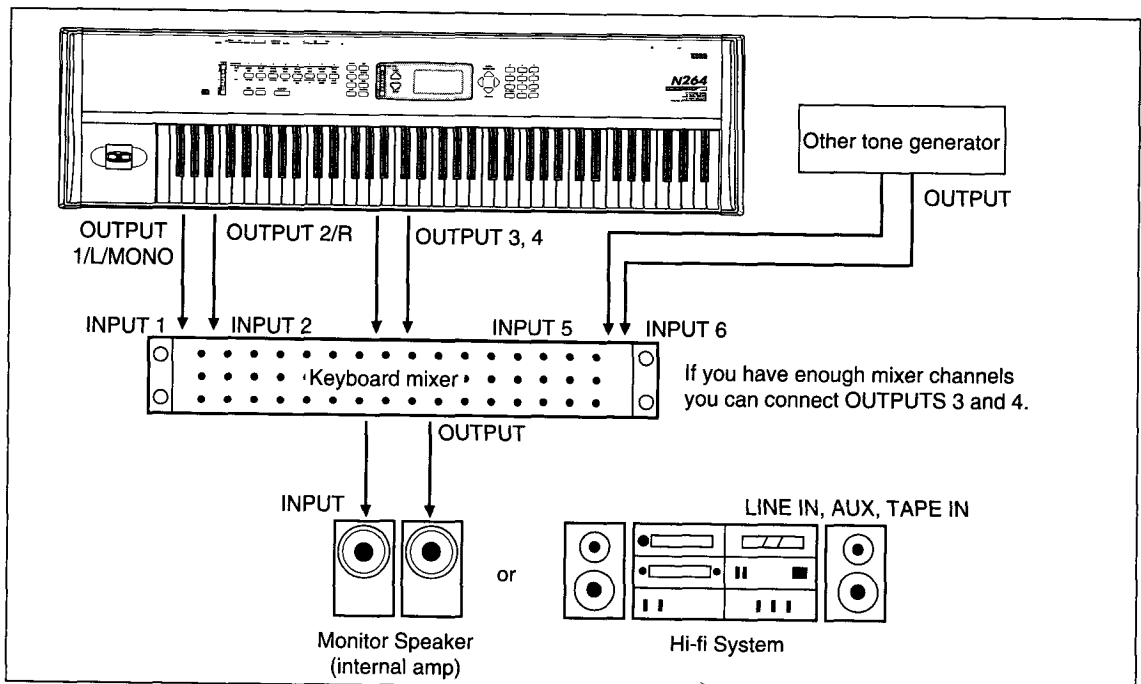

Note: Professional audio equipment such as the N264/N364 usually has a broad dynamic range. If you connect the N264/N364 to a domestic hi-fi system, be careful not to raise the volume level too high because you may damage the speakers.

Power On Procedure

When you have made all the necessary connections, press the [POWER] switch to power on the N264/N364. Then power on your mixing console (if applicable), and then the amplifier. At this point do not turn the power to the N264/N364 off and on, you may damage the speakers. After you turn on the power to the N264/N364, the LCD screen will display “N264 (or N364) MUSIC WORKSTATION” for a few seconds. Then Combination Play mode* will be selected.

Pressing the power switch when the N264/N364 is on will turn off the power to the N264/N364. At this time, all internal Programs, Combinations, drum kits, global parameters, and sequencer data are stored. Edits that have not been written, however, will be lost.

Do not power off the N264/N364 while the disk drive LED is lit, or when a “Loading” or “Saving” message is shown on the LCD. Otherwise, the disk, data, or both may be damaged.

*“Mode” refers to the operating status of the N264/N364. The N264/N364 has ten modes. See “N264/N364 Modes” on page 5 of this manual.

LCD Contrast

The LCD screen of the N264/N364 is brighter than on previous models, but its readability is affected by the viewing angle. Depending on the location of the unit, you may need to adjust the factory-set contrast setting. If necessary, rotate the rear panel CONTRAST knob to maintain good readability.

Listening to the Demo Songs

After completing the audio connections, you can listen to the demo songs that have been loaded into the N264/N364 sequencer. Raise the volume level to about half way, and raise the volume level of the mixing console and amplifier slightly. Press the [START/STOP] button to start the demo song. Press the [START/STOP] button again to stop the demo song. Adjust the volume level of the mixing console and amplifier while listening to the song. Enjoy the wonderful sound of the Korg N264/N364.

If you hear no sound, check all the connections. Try connecting a pair of headphones to the PHONES output. If you can hear the demo song in the headphones, the problem must be a connection or device further down the line.

Listening to the Realtime Pattern Play demo

The N264/N364 contains demo song data, and data that lets you try out its Realtime Pattern Play capabilities.

Songs 0–2 contain data that lets you hear the N264/N364 perform. See the procedure of “Listening to the Demo Song” given above, and listen to the playback.

Songs 3–6 contain sounds for use with the Realtime Pattern Play function. You can play them in conjunction with Realtime Pattern Play pattern sets.

- 1) After listening to the demo songs, press the [↑] button. You will enter Realtime Pattern Play/Recording (RPPR) mode, and the PS parameter (which chooses the Pattern Set) will be selected.
- 2) Use the VALUE slider or the [▲/YES][▼/NO] buttons to set PS to a value of 3.
- 3) Press the [←] button. The S parameter (which chooses the song) will be selected.
- 4) Use the VALUE slider or the [▲/YES][▼/NO] buttons to set S to a value of 3.
- 5) Play any key on the keyboard. The pattern assigned to that key will playback.

Some patterns will continue to playback after you release the key, but such patterns can be stopped by pressing the same key again, or by pressing the C2 key (the key at the far left of the keyboard).

If you wish to use RPPR with other settings, try changing the PS and S settings. When doing so, set PS and S to the same values. This will select the most appropriate combination of data.

- 6) Press the [↓] button to exit RPPR mode.

Using Arpeggio mode

- 1) Press the [PROG] button to move to Program Play mode.
- 2) Use the VALUE slider or the [▲/YES][▼/NO] buttons to select a Program. (Select a sound with a rapid attack, such as a piano.)
- 3) Press the [↓] button to move to Arpeggio mode.
- 4) Press keys on the keyboard and an arpeggio will sound.

You can use the function buttons to select arpeggio parameters and change their settings. The main parameters are as follows.

Function button [1]: arpeggio type (UP, DOWN, etc.)

Function button [3]: arpeggio range (in octave units)

Function button [8]: arpeggio speed

- 5) Press the [↑] cursor button to exit Arpeggio mode.

MIDI Connections

After listening to the demo song to check the audio connections, you're ready to make the MIDI connections. The N264/N364 is an integrated music workstation, allowing you to create high-quality music. Furthermore, it has a wide-range keyboard, a sequencer comparable with a stand-alone sequencer, and it also works as an excellent master keyboard in a large-scale MIDI system.

1) Connecting to a Tone Generator (Synthesizer)

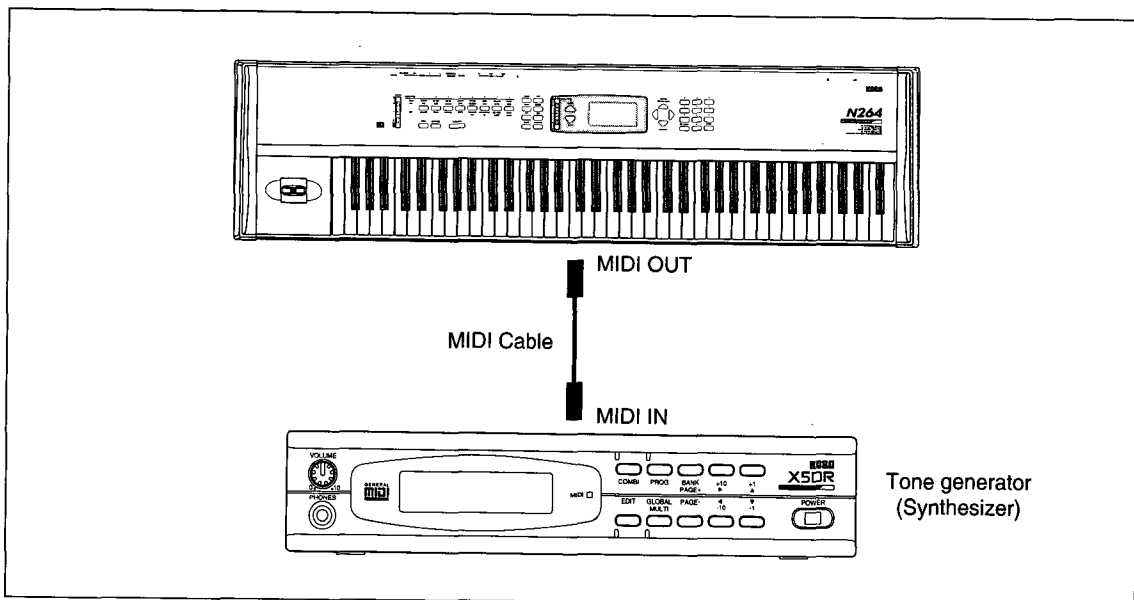

2) Connecting to a MIDI Sequencer

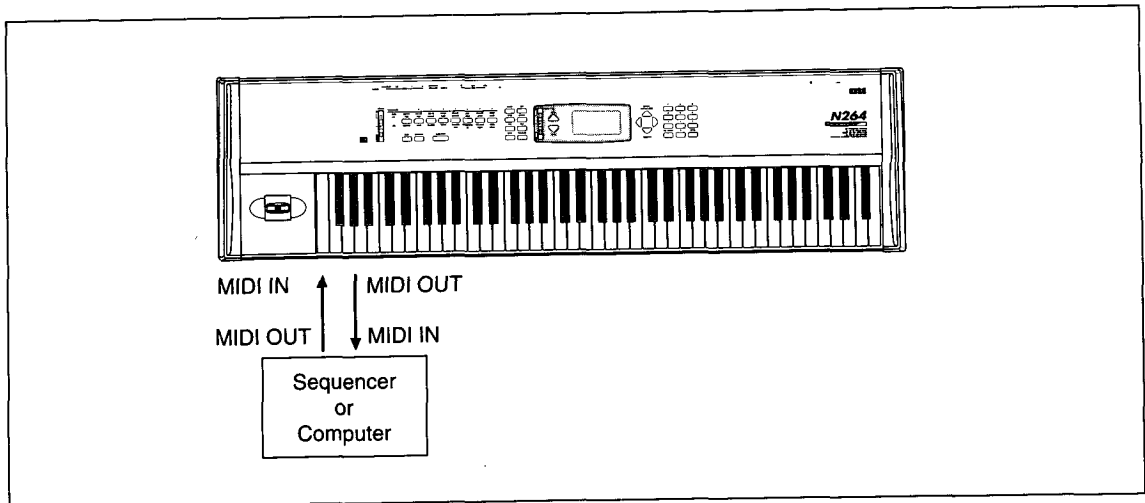

3) Connecting to a Tone Generator (Synthesizer) and MIDI Sequencer

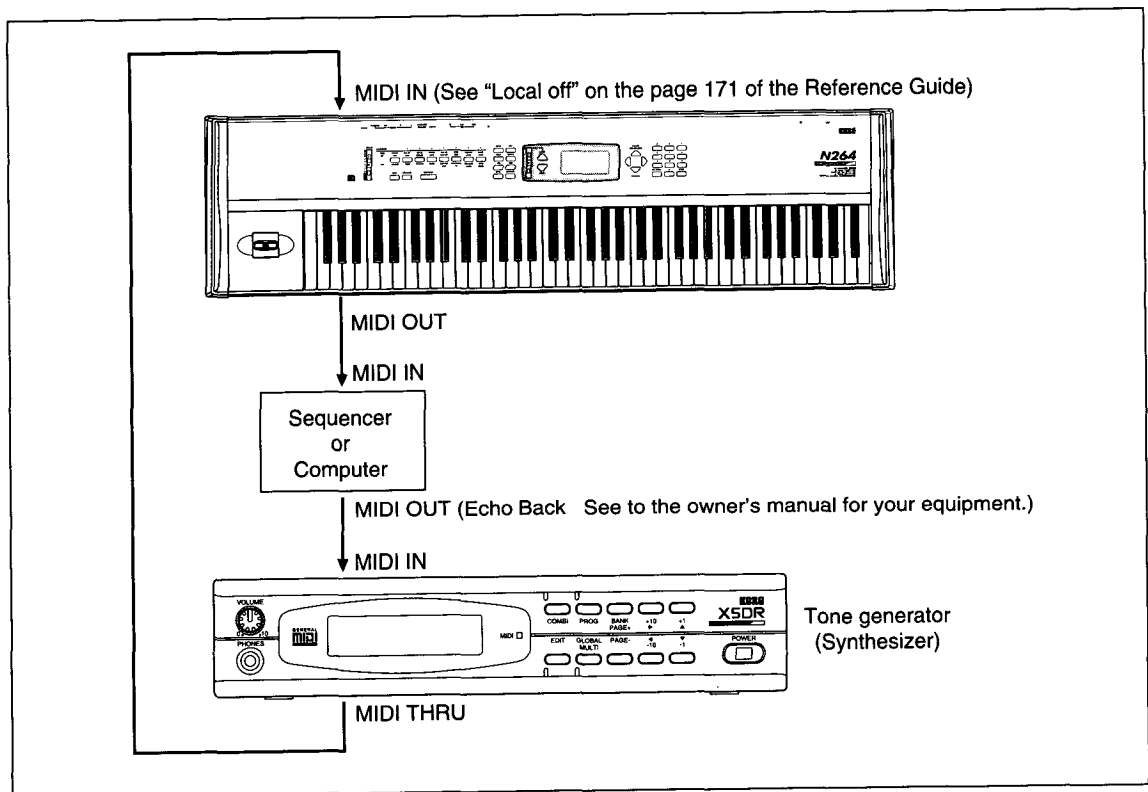

Do not connect more than three MIDI devices via MIDI THRU, because MIDI signals may be delayed. We recommend you use a MIDI patch bay to configure a reliable and efficient system.

4) Using a MIDI Patchbay

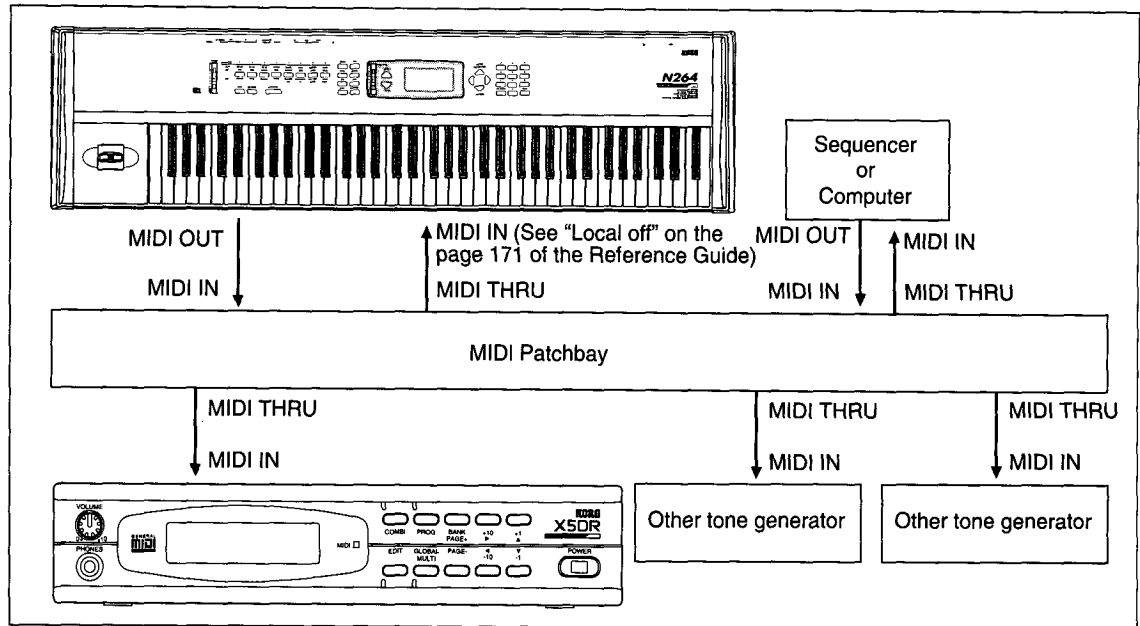

Note: If a tone generator produces no sound, it may be due to a faulty MIDI cable. Use only high-quality MIDI cables, and make sure all connections are complete.

Chapter 3: Getting Around the N264/N364

The LCD

This section explains the various characters and symbols that appear on the N264/N364 LCD.

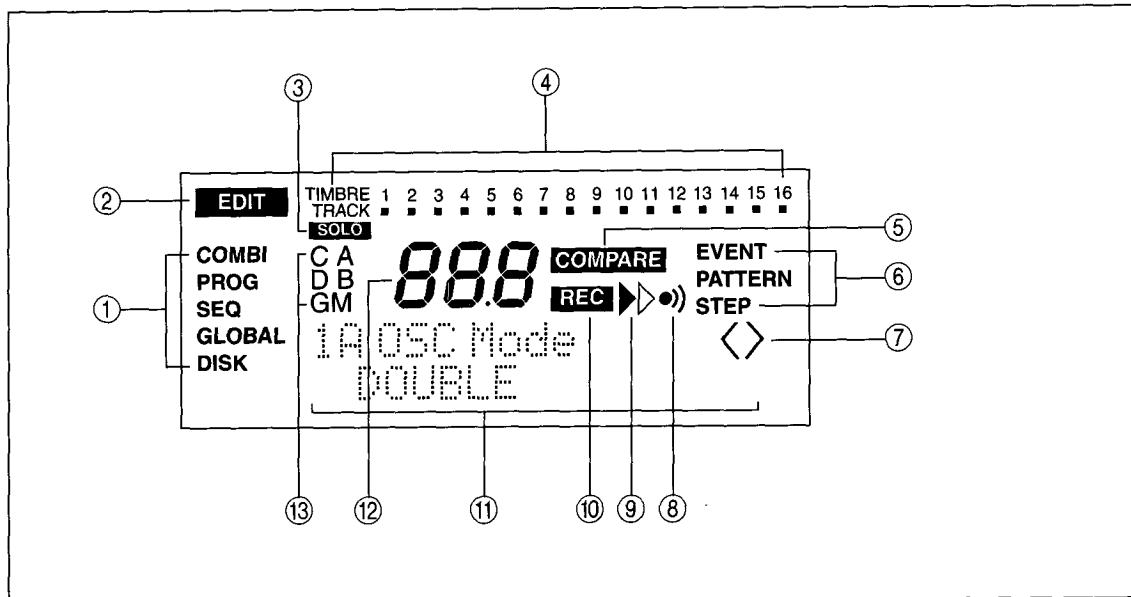

1) Modes

These indicate the current mode.

2) EDIT

This indicates that the current mode is an Edit mode.

3) SOLO

In Combination Play mode, this indicates that a Timbre is soloed. In Sequencer modes, it indicates that a track is soloed.

4) TIMBRE, TRACK

In Program Play mode, the numbers 1 to 16 are displayed. A flashing number indicates the Global MIDI Channel setting. When MIDI Note On/Off messages are received, a box below the corresponding MIDI Channel number flashes.

In Combination Play mode, the numbers 1 to 8 correspond to Timbres 1 to 8. When MIDI messages are received, a box below the corresponding Timbre number flashes. No number indicates that a Timbre is turned off.

In Sequencer mode, numbers 1 to 16 correspond to tracks 1 to 16. A flashing number indicates the currently selected track. When MIDI messages are received, a box below the corresponding track number flashes.

5) COMPARE

This indicates that the Compare function is active.

6) EVENT, PATTERN, STEP

In Sequencer Edit mode, EVENT appears when using event related LCD screens, PATTERN appears when using pattern related LCD screens, and STEP appears when using step related LCD screens.

7) <>

These indicate that other LCD screens are available within the current group.

When another LCD screen is available to the left, "<" is shown. When another LCD screen is available to the right, ">" is shown. When LCD screens are available to both the left and right, "<>" is shown.

In Arpeggio mode, “<” and “>” will blink alternately in time with the speed.
In RPPR mode, both “<” and “>” will be displayed.

8) Metronome

This indicates that the metronome is on.

9) Beat Indicators

These indicate the beat.

- ▶ This indicates the first beat of a measure.
- ▶ This indicates the other beats.

10) REC

This indicates that recording is in progress.

11) Character Display

Program names, Combination names, song names, parameters, etc., are displayed on these two lines. The top line can display 14 characters, and the bottom line, 16 characters.

Most of the LCD screens in the N264/N364 manuals show just these two lines.

12) Three Large Digits

In Program Play mode and Combination Play mode, these indicate the number of the currently selected Program or Combination, respectively. In Sequencer modes, they indicate the current song measure.

The dot between the right-two digits indicates that the [10's HOLD/-] button is active.

13) Bank/Measure

In Program Play mode, this indicates the selected Program bank. If a RAM bank is selected, this will indicate ‘A’ or ‘B’. If a ROM bank is selected, this will indicate ‘C’, ‘D’, or ‘GM’.

In Combination Play mode, this indicates the selected Combination bank. If a RAM bank is selected, this will indicate ‘A’ or ‘B’. If a ROM bank is selected, this will indicate ‘C’ or ‘D’.

In Sequencer mode, an ‘M’ will be displayed to show that the middle three numeric digits indicate the measure number.

Selecting LCD Screens

N264/N364 functions are organized into modes: Program Edit mode, Combination Edit mode, Sequencer Edit mode, Disk mode, and Global mode. In these modes, LCD screens are identified alphanumerically. For example, in Program Edit mode the INIT PROG function is located on LCD screen 8E, as shown below. To select LCD screen 8E, press function button [8], then press the [↑] cursor button four times.

```

8E INIT PROG
  OK?
  
```

For some functions, there may be one, two, three, or more LCD screens available. These are called LCD screen groups. If more LCD screens are available, left or right angle brackets "< >" are shown on the right-hand side of the LCD. In this case, use the [←] and [→] cursor buttons to select the other screens.

On the N264/N364, LCD screens in a group all display the same number (e.g. 1A or 3E). In the N264/N364 manuals, however, LCD screens in a group are numbered as 1A-1, 1A-2, etc. To select the first LCD screen in a group, press the corresponding function button. For example, to select LCD screen 4A-1, press function button [4]. To select the other LCD screens in the group, use the [←] and [→] cursor buttons. For example, to select LCD screen 4A-3, first press function button [4], then press the [→] cursor button twice.

To select other LCD screen groups, press the corresponding function button, or use the [↑] and [↓] cursor buttons. Basically, LCD screens are organized in a grid, as shown below.

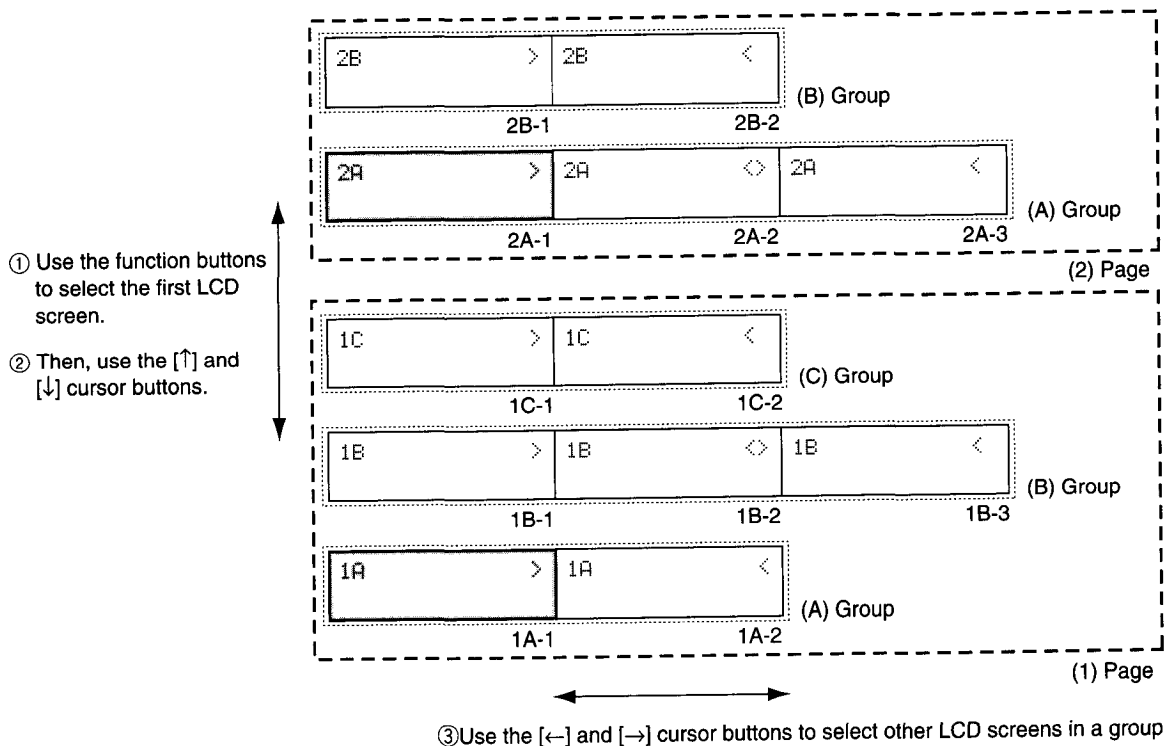

Selecting Parameters

On most of the LCD screens, a number of parameter values are displayed simultaneously. The currently selected parameter is the one that is flashing. To select other parameters, use the [←] and [→] cursor buttons.

Setting Parameters

There are four ways in which you can set parameters:

- Using the VALUE slider
- Using the [▲/YES] and [▼/NO] buttons
- Using the number keypad
- Using a MIDI keyboard (works for a few functions only)

VALUE slider: select the parameter that you want to adjust, then adjust the slider. Slide it upward to increase a value, and downward to decrease it.

[▲/YES] and [▼/NO] buttons: Pressing [▲/YES] will increase the value, and pressing [▼/NO] will decrease it.

While editing, pressing both of these buttons simultaneously will reset the selected parameter to the value that it originally had when you selected it (the Undo function).

Number keypad: Use these buttons when you already know the value that you wish to input, such as when selecting the Program for one of the Timbres in a Combination, or when selecting a Multisound. Use the number keys [0]—[9] to specify the number, and then press the [ENTER] button to input the number. For example if you wish to input a value of 58, you would press the number buttons [5] and then [8], and then press the [ENTER] key.

To enter a negative value, to change a value from positive to negative or vice versa, or to change the Program bank in Combination Edit mode 1A or in Sequencer mode, press the [10's HOLD/-] button

Note: *If you specify a value that is outside the selected parameter's range, the highest or lowest available value for that parameter will be selected.*

A MIDI Keyboard: connected to the N264/N364's MIDI IN can be used to specify note values for parameters such as Key Window, which accept note value input.

When editing drum kits in Global mode, holding down the [ENTER] button and pressing a key selects the drum index assigned to the that key. Note that when the transpose function is active, these key positions are different.

Comparing While Editing

[COMPARE] button: while editing Programs and Combinations, press the [COMPARE] button to listen to the original version. The word "COMPARE" will appear on the LCD. Press the [COMPARE] button again to return to the edited version.

[▲/YES] & [▼/NO] buttons: to reset a parameter value to the value that it was when you first selected it, press the [▲/YES] & [▼/NO] buttons simultaneously.

Useful Notes

Front Panel Colors: On the N264/N364 front panel, function key functions for Sequencer mode are printed in green, and functions for Program Play mode or Arpeggio mode are printed in white.

Effects: in Program Edit mode, Combination Edit mode, and Sequencer Edit mode, you can set up the effects by pressing function button [7].

Quick Write: in Program Play mode, Program Edit mode, Combination Play mode, and Combination Edit mode, you can write to memory at anytime by pressing the [REC/WRITE] button, then the [▲/YES] button.

Page memory: If the Global mode 4D Page Memory setting is ON, the location of the previously selected parameter will be remembered when you move from one mode to another mode, and the same parameter will again be selected when you return to the previous mode.

MIDI Notes

The N264/N364 responds to incoming MIDI notes from C-1 to G9 (MIDI Note numbers 0 to 127). However, some Programs may not produce any sound at the top end of the range.

The following table shows how MIDI Note numbers correspond to keyboard notes.

Note	C-1	C0	C1	C2	C3	C4	C5	C6	C7	C8	C9	G9
MIDI Note Number	0	12	24	36	48	60	72	84	96	108	120	127

Chapter 4: Program Play Tutorial

The N264/N364 has two types of sounds: Programs and Combinations. Programs are the basic sounds that you can play. Combinations consist of a number of Programs, and are used to create more complex tone colors, useful for live performance and sequencer work.

First we'll listen to some Programs.

- 1) Press the [PROG] button to enter Program Play mode. The following illustration shows the location of the [PROG] button.

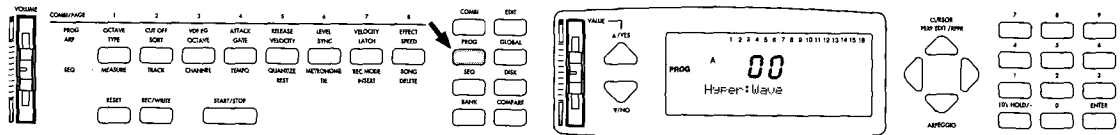

- 2) Play your MIDI keyboard or send MIDI Note data from your sequencer. The N264/N364 will produce sound.

Note: If there is no sound, move to Global mode and check the Local ON/OFF setting (See page 171 of the Reference Guide), and if you are using MIDI connections, check that the MIDI channels of the transmitting and receiving devices match (See page 170 of the Reference Guide).

Changing the N264/N364 Global MIDI Channel

In Program Play mode, the N264/N364 recognizes MIDI Note data on the Global MIDI Channel. Initially, this is set to MIDI Channel 1. If necessary, change the MIDI Channel on the MIDI keyboard or sequencer. To change the N264/N364 Global MIDI Channel, press the [GLOBAL] button to enter Global mode, then press function button [3] (or press the [↑] cursor button four times) to select LCD screen 3A. Now that the MIDI Channel parameter (CH) has been selected, use the VALUE slider or the [▲/YES] and [▼/NO] buttons to set it. The following illustration shows the locations of the [GLOBAL] button and function button [3].

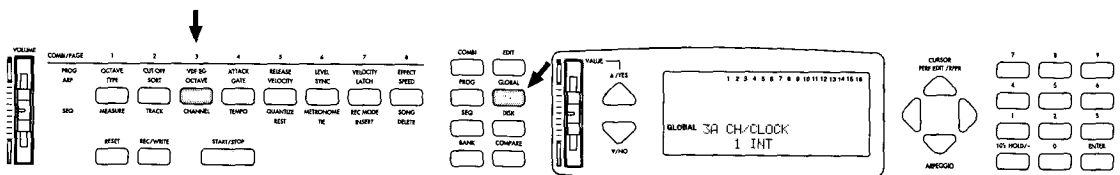

Selecting Banks & Programs

Selecting Banks

Programs are stored in banks A, B, C, D and GM. By pressing the [BANK] key you can switch banks. Of these banks, GM contains GM-compatible preset programs. Since banks C, D and GM are ROM, you cannot write data into these banks. (However, you can edit Programs from banks C, D or GM, and then write the edited Program into bank A or B.)

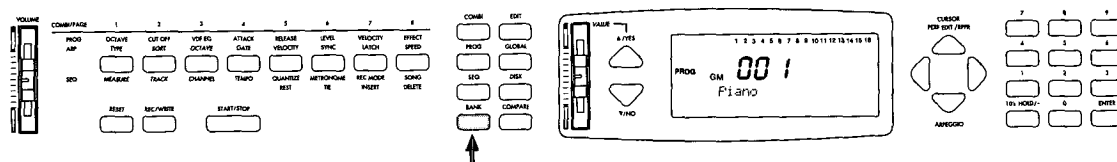

Selecting Programs

Programs can be selected using the N264/N364 number keypad, the [▲/YES] and [▼/NO] buttons, or by sending a MIDI Program Change message from a MIDI keyboard or sequencer.

You can select Programs directly by entering the Program number via the number keypad. With the [10's HOLD/-] button, Programs can also be selected with just one button press.

Pressing the [10's HOLD/-] button will display a dot between the right-two digits on the LCD. At this time, pressing the number keypad changes the unit's digit of the Program number. Pressing the [▲/YES] and [▼/NO] buttons changes the ten's digit. This allows you to select Programs easily. The following illustration shows the location of the [10's HOLD/-] button.

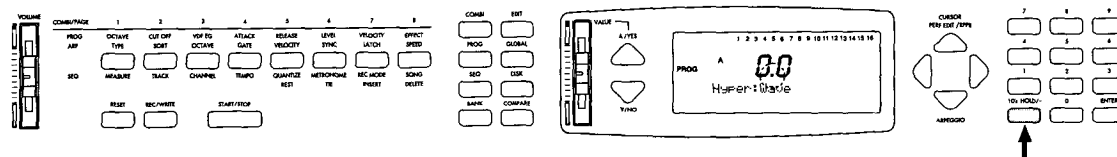

Pressing the [▲/YES] and [▼/NO] buttons selects Programs sequentially. The following illustration shows the location of the [▲/YES] and [▼/NO] buttons.

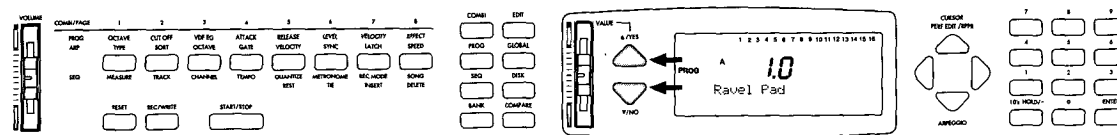

Note: The 10's HOLD function is canceled when the N264/N364 receives a MIDI Program Change message. MIDI Program Change numbers 100–127 are interpreted as 00–27 for all banks except GM.

Editing in Program Play Mode

Comprehensive editing of Programs can be done in Program Edit mode. However, some parameters are also available for editing in Program Play mode as well. The following eight parameters can be edited from Program Play mode: Octave (the octave switch, function button [1]), Cutoff (brightness, function button [2]), VDF EG (time-varying change in tone, function button [3]), Attack (attack time, function button [4]), Release (time from the release of the note until the sound disappears, function button [5]), Level (volume, function button [6]), Velocity (sensitivity of tone or volume to playing dynamics, function button [7]), and Effect (the depth of the effect, function button [8]). Since each of these parameters play an important role in the sound, you can make both subtle and drastic changes to a Program while remaining in Program Play mode.

When you press a function button, the parameter name printed in white above the PROG line will appear in the LCD. Use the VALUE slider, the [▲/YES] and [▼/NO] buttons, or the number keypad to modify the value. Modifications here can be made in a range of ± 10 , but the actual parameter value that results from your editing will be shown in the bottom line of the LCD.

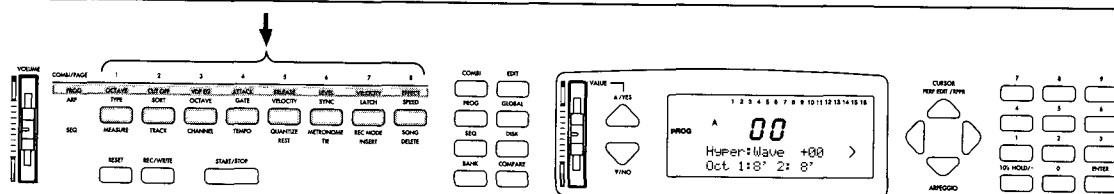

These changes are temporary, and if you move to a different Program your edits will be lost (the original settings will reappear). If you wish to keep the edited values, you must write the Program into memory. To do this, press the [REC/WRITE] button. An “Are You Sure?” message will appear. If it is OK to overwrite the data currently occupying that Program number, press the [▲/YES] button to write the Program. (Programs from bank C or GM will be written to bank A, and Programs from bank D will be written to bank B.) Be aware that when you write a Program, the previous data existing at that Program number will be overwritten and lost. If you wish to modify the Program name or to write the data into a different Program number, you will have to move to Edit mode. For details See pages 32–33 of the *Reference Guide*.

Chapter 5: Combination Play Tutorial

Combinations consist of a number of Programs, and create tone colors more complex than those possible using Programs alone. They are ideal for live performance and sequencer work.

- 1) To enter **Combination Play mode**, press the [COMBI] button. The following illustration shows the location of the [COMBI] button.

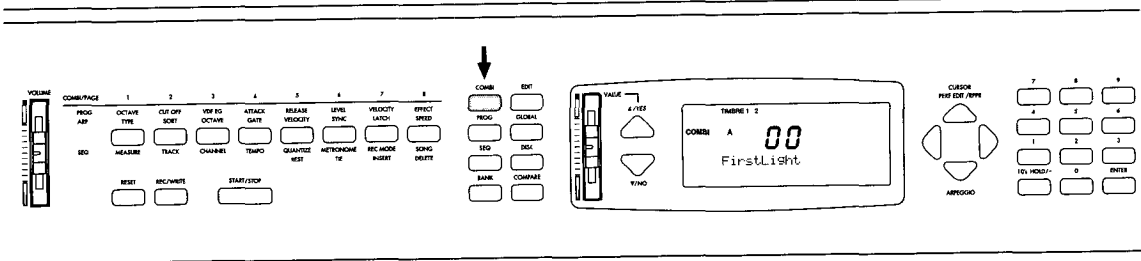

Before you start playing, let's take a look at Combination structure and Timbre MIDI Channels.

Combination Structure

Combinations can consist of up to eight Programs. In a Combination, Programs are handled as Timbres. In Combination Play mode, the word TIMBRE and several numbers are displayed at the top of the LCD. The numbers indicate which of the available eight Timbres are actually being used in the selected Combination. On the LCD shown below, Combination A00 "FirstLight" is selected, and numbers 1 and 2 are displayed. This means that the "FirstLight" Combination uses two Timbres (i.e., two Programs).

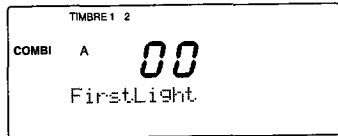

In Combination Play mode, function buttons [1] to [8] correspond to Timbres 1 to 8. Pressing a function button will display the name of the Program assigned to the corresponding Timbre. Double-pressing a function button quickly activates the Solo function. This allows you to listen to Timbres individually. Double-press the respective function button again to cancel Solo. The following illustration shows the location of the function buttons.

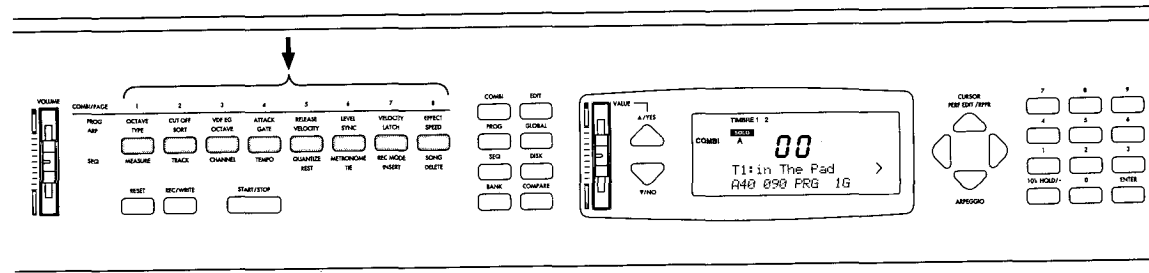

Playing Combinations

Now let's play a Combination. Either play the keyboard, or transmit MIDI note data from an external sequencer connected to the MIDI IN connector. The N264/N364 will produce sound.

If playing the keyboard does not produce sound, check that the MIDI channels of each Timbre and the Global MIDI channel match. If you are using a MIDI device to play the N264/N364, also check that the MIDI channels of the transmitting device match the MIDI channels of each Timbre. With the factory preset data, all Timbres are set to MIDI channel 1.

Timbre MIDI Channels

In Combination Play mode, Timbres can be assigned to different MIDI Channels, so each Timbre will respond only to MIDI Note data on its assigned MIDI Channel. Initially, all Timbres are assigned to MIDI Channel 1. If necessary, change the MIDI Channel on the MIDI keyboard or sequencer. To set a Timbre's MIDI Channel, press a function button to select the Timbre, then press the [→] cursor button three times. "MIDI CHANNEL" will flash on the LCD. Use the VALUE slider, the [▲/YES] and [▼/NO] buttons, or the number keypad to select a MIDI Channel. The following illustration shows the location of the function buttons and the [→] cursor button.

A 'G' will be displayed at the right of channels which match the Global MIDI channel (i.e., the channel which will sound when you play the keyboard of the N264/N364).

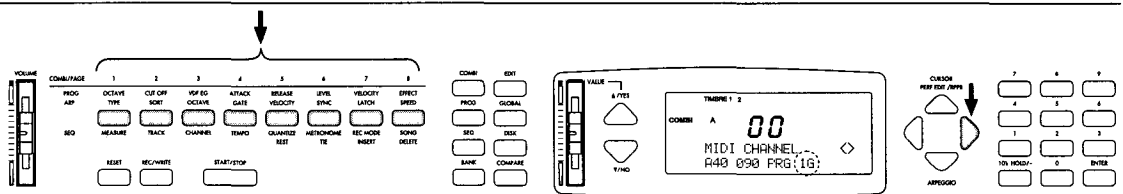

When incoming MIDI data causes a Combination to sound, a '[' will blink in the upper part of the LCD screen. This indicates the Timbre that actually sounded at this time. Even if each Timbre is set to a different MIDI channel, this indicator will tell you which Timbre is sounding.

Selecting Banks & Combinations

Selecting Banks

Combinations are stored in banks A, B, C and D. You can select a Bank by pressing the [BANK] button. The following illustration shows the location of the [BANK] button.

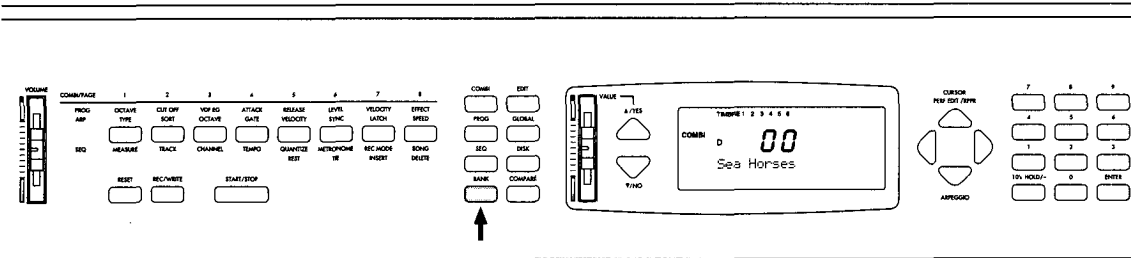

Selecting Combinations

Combinations can be selected using the N264/N364 number keypad, the [▲/YES] and [▼/NO] buttons, or by sending a MIDI Program Change message from a MIDI keyboard or sequencer.

You can select Combinations directly by entering the Combination number via the number keypad. With the [10's HOLD/-] button, Combinations can also be selected with just one button press.

Pressing the [10's HOLD/-] button will display a dot between the right-two digits on the LCD. At this time, pressing the number keypad changes the unit's digit of the Combination number. Pressing the [▲/YES] and [▼/NO] buttons changes the ten's digit. This allows you to select Combinations easily. The following illustration shows the location of the [10's HOLD/-] button.

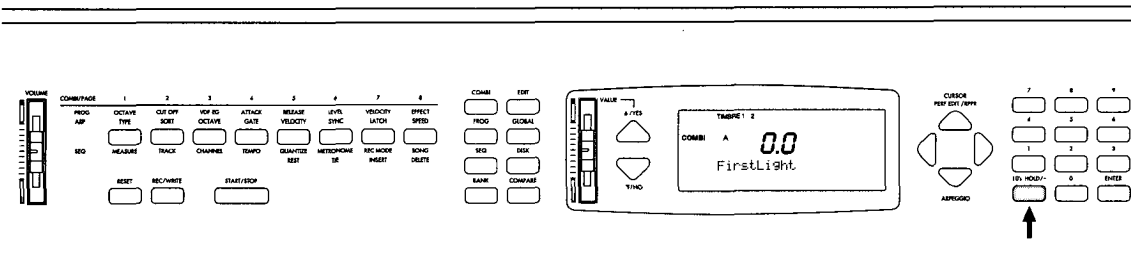

When a period is displayed, pressing the number keypad will change only the one's digit, while the ten's digit remains fixed. Also in this case, pressing the [▲/YES] or [▼/NO] buttons will change only the ten's digit, while the one's digit remains fixed.

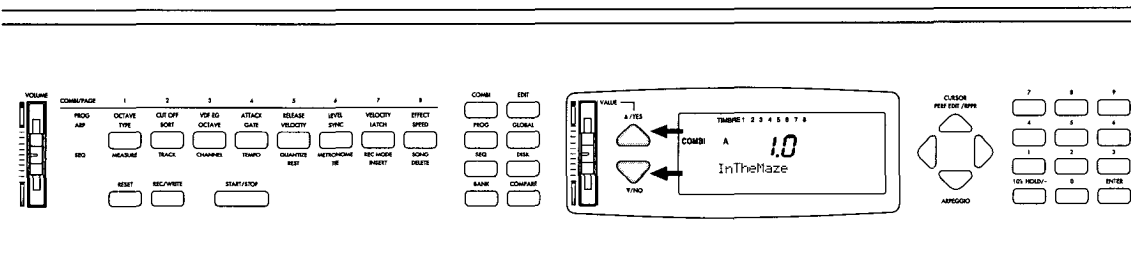

Note: Combinations can be selected by a Program Change message received from an external MIDI device. In this case, the 10's HOLD function will be canceled. MIDI Program Change numbers 100–127 are interpreted as 00–27.

Editing in Combination Play Mode

Comprehensive Combination editing is normally carried out in Combination Edit mode. However, you can edit some Combination parameters in Combination Play mode. These parameters include: 1) Program to Timbre assignment, 2) Level, 3) Pan, and 4) MIDI Channel.

These parameters appear on the bottom line of the LCD when a function button is pressed. Remember that function buttons [1] to [8] correspond to Timbres [1] to [8]. Use the [←] and [→] cursor buttons to select a parameter. The name of the selected parameter flashes on the LCD. Once selected, use the VALUE slider, the [▲/YES] and [▼/NO] buttons, or the number keypad to adjust it. The following illustration shows the location of the function buttons and the [←] and [→] cursor buttons.

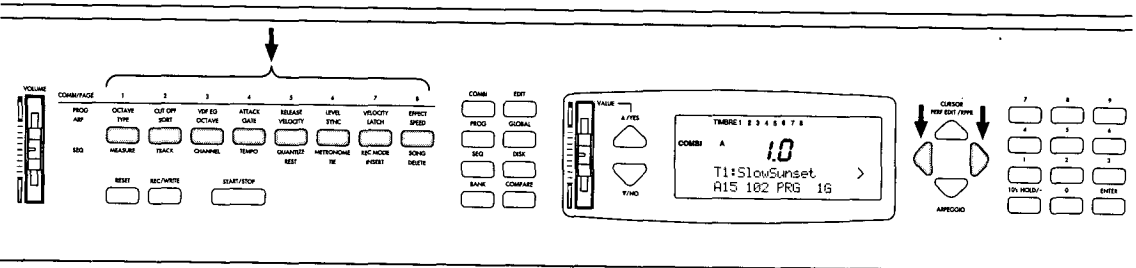

These changes are temporary, and if you move to a different Combination your edits will be lost (the original settings will reappear). If you wish to keep the edited values, you must write the Combination into memory. To do this, press the [REC/WRITE] button. An “Are You Sure?” message will appear. If it is OK to overwrite the Combination currently occupying that number, press the [▲/YES] button to write the Combination. (Combinations from bank C will be written to bank A, and Combinations from bank D will be written to bank B.) Be aware that when you write a Combination, the previous data existing at that Combination number will be overwritten and lost. If you wish to modify the Combination name or to write the data into a different Combination number, you will have to move to Edit mode. For details See pages 54–55 of the *Reference Guide*.

Chapter 6: Combination Edit Tutorial

In Combination Edit mode you can edit existing Combinations and create your own originals. To enter Combination Edit mode, press the [COMBI] button, then the [EDIT] button. For details about setting parameters, see “Setting Parameters” on page 21. Before we start editing, let’s take a look at the various types of Combinations that are available. Understanding the different types and their differences will help you when making Combinations for specific purposes.

Combination Types

Layered

When Timbres are layered together, they produce a thick and complex sounding Combination. Layered sound qualities cannot be achieved by individual Programs alone.

Split

Timbres can be set to respond to a specific range of MIDI Notes. This range is called a Key Window, and it allows you to split a keyboard into several sections, with each section used to play a different Timbre. This allows you, for example, to play a different Program with each hand.

Velocity Switch

Timbres can be set to respond to a specific range of MIDI Note velocities. In this way, only notes within a certain velocity range will cause a Timbre to sound. This range is called a Velocity Window, and allows velocity controlled switching from one Timbre to another as the note velocity increases or decreases.

Velocity Layer

This is similar to a Velocity Switch Combination, although, rather than switch between Timbres, they are gradually layered together as the note velocity increases or decreases. This is achieved by overlapping the Timbre Velocity Windows.

By using the Key Window and Velocity Window parameters together, Combinations with split and switch Timbres can be created.

Editing Combinations

In this tutorial we'll edit Combination C00 Star*Burst. This Combination has a keyboard split point set at note C4. So different sounds are produced by notes above and below the C4 split point. In addition, a Timbre with Velocity Window settings and a Key Window range below C4 is used. This creates a sound with a rising pitch as notes below C4 are played stronger.

Combinations can consist of up to eight Timbres. The Timbre Mode parameter on LCD screen 1B is where Timbres are turned on and off. Press the [↑] cursor button once to select LCD screen 1B. For the Star*Burst Combination, Timbres 1 to 7 are set to INT, and Timbre 8 is set to OFF.

Key Window

To set up layer and split type Combinations, the Timbre parameter Key Window is used to specify a range of MIDI Notes. Press function button [4] or use the [↑] and [↓] cursor buttons to select LCD screen 4A. Use the Key Window Top (KW TOP) parameter to set the highest note in the range. Use the [←] and [→] cursor buttons to select the other Timbres. Then, press the [↑] cursor button to select LCD screen 4B. Use the Key Window Bottom (KW BTM) parameter to set the lowest note in the range. For Star*Burst, the highest note for Timbres 1 and 4 is C4. The highest note for Timbres 6 and 7 is B3. And the lowest note for Timbres 2 and 5 is C#4. The following illustration shows the location of function button [4] and LCD screen 4A.

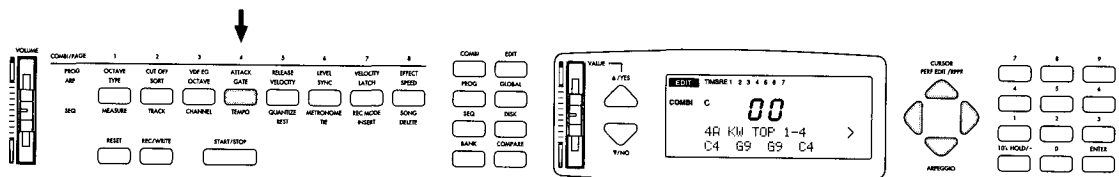

Velocity Window

Just like the Key Window parameters, the Velocity Window parameters also need to be set to use layer and split type Combinations. The Velocity Window parameter is used to specify the range of MIDI note velocities that a Timbre responds to. Select LCD screen 4C. Use the Velocity Window Top (VW TOP) parameter to set the highest note velocity in the range. Use the [←] and [→] cursor buttons to select the other Timbres. Then, press the [↑] cursor button to select LCD screen 4D. Use the Velocity Window Bottom (VW BTM) parameter to set the lowest note velocity in the range. For Star*Burst, the lowest note velocity for Timbre 1 is set to 68.

Using the N264/N364 as a MultiTimbral Tone Generator

In Combination mode, the N264/N364 can be used as an 8-part multi-timbral tone generator with an external MIDI sequencer. Timbres can be assigned to individual MIDI Channels that correspond with the MIDI Channel-to-track assignments on the external sequencer. To set the MIDI Channel for a Timbre, press function button [3] or use the [↑] and [↓] cursor buttons to select LCD screen 3A. The following illustration shows the location of function button [3] and LCD screen 3A. You must first set the 1B Timbre Mode setting to INSTRUMENT.

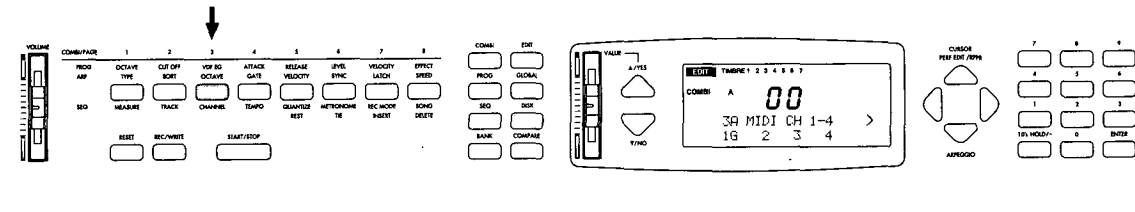

Timbre Programs can be selected by sending MIDI Program Change messages from the sequencer. Most sequencers allow you to record MIDI Program Change messages into tracks. This ensures that the correct Programs are selected for each Timbre. It also allows you to select other Programs during song playback. The MIDI Program Change Filters on LCD screen 6A must be set to “E” for this to work. If set to “D”, a Timbre will ignore MIDI Program Change messages. The following illustration shows LCD screen 6A and the location of function button [6] that is used to access it.

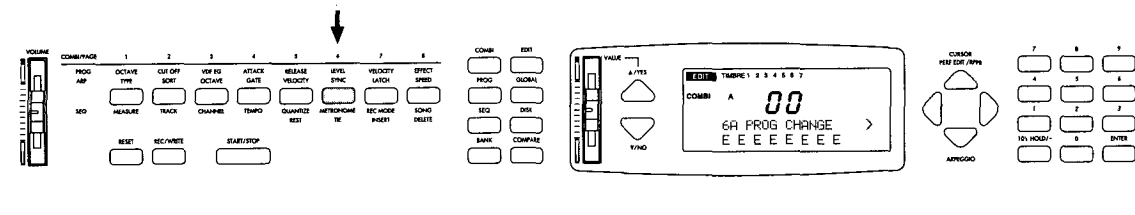

By assigning the same MIDI Channel to Timbres with different Key Window and Velocity Window settings, layer and split techniques can be applied easily to sequencer data.

Although you can use the N264/N364 in Sequencer mode to provide 16-part multitimbrality, if 8-part multitimbrality is sufficient, we recommend that you use Combination Play mode, in which you can select Combinations using MIDI Program Change messages. However, if you want to use Sequencer mode for multitimbral work, see page 93 of the *Reference Guide*.

Saving Combinations

If you select another Combination without saving first, your edits will be lost. If you want to save them, you must write the Combination to memory. To do this, press the [REC/WRITE] button. An “Are You Sure?” message will appear. Press the [▲/YES] button to write the Combination, or the [▼/NO] button to cancel. Note that if you write, you will overwrite the Combination that already exists with that number. To write the Combination to a different Combination number or change its name, you need to enter Combination Edit mode. See “8A Combination Write” on page 54 of the *Reference Guide*.

In the editing example on the previous page, data cannot be saved to bank C since it is a ROM bank. Save the edited Combination to either bank A or B.

Chapter 7: Effects Tutorial

Two of the N264/N364's main features are its built-in digital multi-effects processors. This tutorial describes the different effect types and how to use them. Effects can be selected on LCD screens 7A and 7C in Program Edit mode, Combination Edit mode, and Sequencer Edit mode.

What is a Multi-Effects Processor?

An effects processor is used to add effects to sound that has been converted into an electronic signal, such as the sound from a synthesizer, guitar, or microphone. For example, reverb and delay type effects can be used to add acoustic ambience and echoes to electronic instruments in the recording studio. Equalizers can be used to produce subtle or drastic tonal changes to a sound. These various effects are usually produced by a number of dedicated devices. However, multi-effects processors, like those in the N264/N364, can produce all these effects. The N264/N364 reverb effects allow you to simulate the acoustic ambience from a small hall to that of the grand canyon. Most of the other effects can be used as part of the sound creation process itself, further increasing the possibilities for original sound creation.

Effect Types

The N264/N364's 47 effects are based on 12 primary effects. In this section we look at each of these primary effects in detail.

Effects that Add Acoustic Ambience to a Sound

Effects that add a sense of Acoustic Ambience to a Sound are typically called reverb.

1) Reverb

Sounds exhibit a wide variety of reverberations, depending on the size of the surrounding acoustic environment and the materials used in nearby walls, ceiling, etc. Reverb is used to simulate these naturally occurring reverberations for dry sounds. Dry sound refers to the original sound without effects. Sounds with effects are sometimes said to be wet. The N264/N364 features nine types of reverb effects—from 1:Hall through to 9:Spring. Each reverb effect simulates the acoustic ambience of a different environment space.

Let's look at the nature of reverberations. Imagine making a noise in a hall. After hearing the dry sound directly from the source, you will hear a number of sounds reflected from the walls, ceiling, floor, and any other objects with hard surfaces. These are called the early reflections. The time between the dry sound and these early reflections is called the pre-delay time, and it will vary depending on the size of the hall. Eventually, these reflections become less intense and they start to merge together to form a dense reverb that gradually fades away. The time that it takes for the reverb to fade away is known as the reverb time. This is also dependent on the size of the hall.

The tonal quality of these reflections depends on the material used in the walls, ceiling, and other objects in the room. If a room contains many soft materials, for example, they will tend to absorb the high frequencies. So the reverb will appear to contain few high-frequency reflections. This can be simulated using a reverb effect's High Damp parameter.

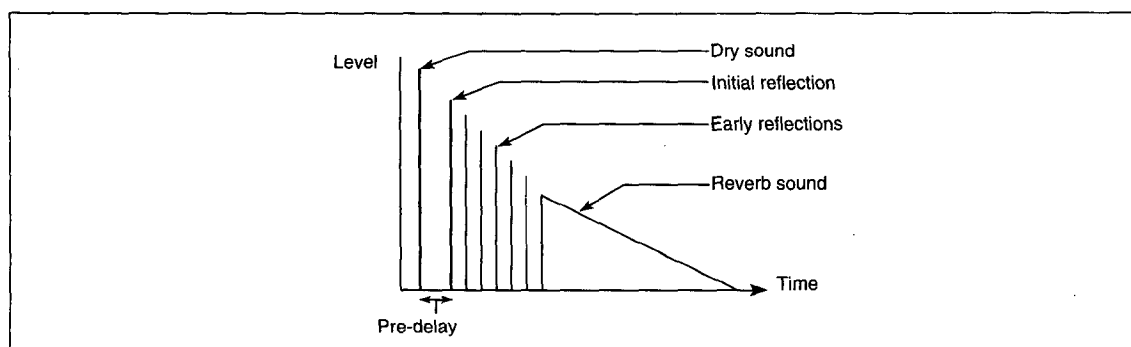

Spatial Effects for the Sound Creation Process

As well as providing spatial simulation, the following effects can also be used as part of the sound creation process itself. These include early reflection, delay, chorus, and flanger.

2) Early reflection

This effect produces just the early reflections of a reverb effect. Using just these early reflections, you can add weight to a sound or create gated reverb type effects. The N264/N364 contains three early reflection effects: 10:EarlyRef1, 11:EarlyRef2, and 12:EarlyRef3. In the EarlyRef3 effect, the volume level of the reflections increases over time, producing a sort of backward effect.

3) Delay

Although both reverb and delay use sound delay techniques, they are in fact totally different effects. Reverb is what you hear in a hall, and delay is what you hear in the mountains. While reverb consists of a gradually fading wash of reflections, delay consists of a series of distinct repeats at regular intervals. The time between the dry sound and the first delay sound is called the delay time. Subsequent repeats are caused by feeding the signal back into the effect. The number of repeats is usually determined by a Feedback parameter. The N264/N364 contains six types of delay: from 13:StereoDly to 18:M. TapDly. Basic delay effects are used to add spatial character to a sound. The N264/N364's more complex delays, such as cross and multi-tap, are best used as part of the sound making process to create new and exciting sounds.

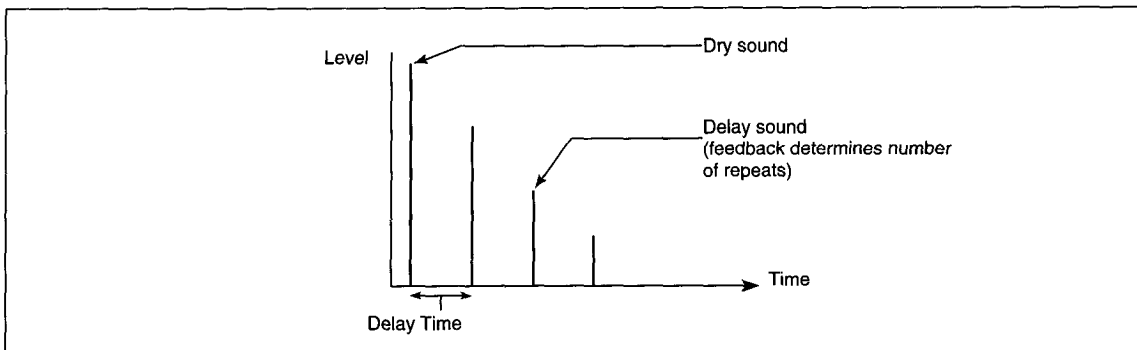

4) Chorus

The chorus effect simulates the ensemble sound of several musicians, and it is ideally suited for use with electric pianos, strings, guitars, and so on.

In an ensemble, pitch variations between instruments create a rich, slightly warbling sound. Essentially, this gives the impression that a number of musicians are playing together. The chorus effect simulates this by delaying the signal and modulating the delay time using a low frequency oscillator (LFO). Modulating the delay time produces a continuously changing pitch. The delayed signal is then mixed with the dry signal to produce the slight warbling sound of a real ensemble.

The speed of the LFO, and in turn the pitch variations, is determined by the modulation speed. The amount by which the LFO modulates the delay time, and hence the pitch, is determined by the modulation depth.

The N264/N364 contains six chorus effects: from 19:Chorus1 to 24:Symp. Ens.

5) Flanger

Although similar to chorus, a flanger uses a shorter delay time and feeds some of the output signal back into the effect. This results in an effect that is significantly different to chorus. Technically speaking, a flanger utilizes a comb filter to alter the pitch characteristics of a sound. Flangers work very well on sounds that contain a lot of harmonics.

The N264/N364 contains three flanger effects: from 25:Flanger 1 to 27:XovrFlngr.

Effects that Change a Sound's Tonal Quality

The following effects change a sound's tonal quality.

6) Exciter

The exciter effect (28:Exciter) adds new harmonics to a sound, thus producing a subjective increase of clarity and definition, which helps to make a sound's individual character stand out.

7) Enhancer

The enhancer effect is similar to the exciter, but with a delay for creating a more spatial sound with a wider stereo width.

8) Distortion

Originally developed for use with guitars, the distortion effect simulates the distortion produced when amplifier circuits are overdriven with excessive signal and gain levels. It tends to thicken single sounds, making it very effective for solo instruments. When used with chords it tends to muddy the overall sound. The N264/N364 contains two kinds of distortion effects: 30:Dist and 31:Over Drv.

9) Phaser

As its full name implies—phase shifter—the phaser effect shifts a sound's phase. Without going into details about phase, a phaser utilizes both phase shifting and time delay to produce a more pronounced swirling and swishing sound. While chorus and flanger modulate the delay time, a phaser modulates phase. It is effective with electric piano, guitars, synthesizer sounds, and bass sounds with a reasonable sustain. The N264/N364 contains two phaser effects: 32:Phaser 1 and 33:Phaser 2.

10) Rotary speaker

This effect (34:Rot. Spk) simulates the rotating speaker effect used in organs. In a real rotary speaker cabinet, the horn speaker is actually rotated. This continuous rotation causes a Doppler effect, like the sound you hear when an ambulance drives past with its siren on. At a slow rotation speed the effect is almost like chorus. While at a higher speed it's similar to tremolo. However, the rotary speaker effect does have its own unique character, and it is ideal for use with organ sounds. In fact, the two are synonymous.

11) Tremolo

The tremolo effect produces regular changes in volume level. The Auto Pan effect (35:Auto Pan) creates a stereo type tremolo effect by modulating the left and right channels inversely. This is popular with suitcase style electric pianos. Tremolo effect 36:Tremolo modulates both channels in sync. Tremolo is very effective on long notes and big chords.

12) Parametric equalizer

Effect 37:Para. EQ is a three-band parametric equalizer. The cutoff frequency for the low and high band filters can be set independently. For the mid-band filter, center frequency and bandwidth can be set.

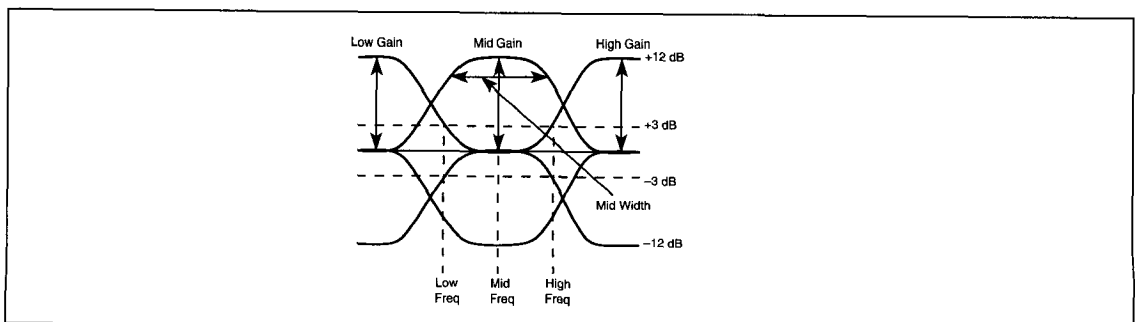

Using the Effects

Connections

There are four buses that feed the two multi-effects processors: A, B, C, and D. Combinations are fed to the effects using their Pan, Send C, and Send D parameters. For Programs, the Pan, Send C, and Send D parameters appear on LCD screens 1B and 1C. For Combinations, the Pan parameters appear on LCD screen 2B, and the Send C and Send D parameters appear on LCD screen 2C. For songs in Sequencer mode, Pan, Send C, and Send D parameters are accessed by pressing function button [2] (TRACK). In Sequencer Edit mode, use LCD screen 1A.

Effects Placements

The two digital multi-effects processors can be used in any one of six placements. Placements affect the way in which the input buses (A, B, C, D) are routed through the processors. To select a placement, select LCD screen 7E. Effect settings and their placements are set independently for Programs, Combinations, and songs. See “7E Effect Placement” on page 59 of the *Reference Guide*.

Chapter 8: Program Edit Tutorial

Although you can make your own Combinations using the preset Programs, you shouldn't limit your creativity by relying on the presets alone. Sound making really starts to get interesting when you create a sound using the various building blocks that go into making a Program. In this tutorial we take a look at the main building blocks that make up a Program and how they work.

As mentioned earlier, some Program parameters can be edited in Program Play mode. However, you need to enter Program Edit mode to access all the parameters. To do this, press the [PROG] button to select Program Play mode, then press the [EDIT] button to select Program Edit mode. For details about setting parameters, see "Setting Parameters" on page 21.

Three Sound Building Blocks

Sounds consist of three main components: pitch, tone, and volume. In a tone generator, each of these components has its own corresponding building block. In the N264/N364, pitch is handled by the OSC (oscillator) block, tone by the VDF (Variable Digital Filter) block, and volume by the VDA (Variable Digital Amplifier) block. The following illustration shows the three blocks.

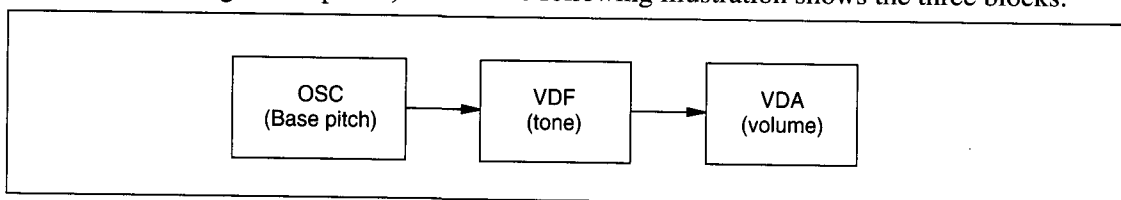

Volume Editing

The volume level of a musical instrument changes over time. The way it changes gives a sound its distinctive character. The following illustrations show how the volume levels of piano and strings change over time.

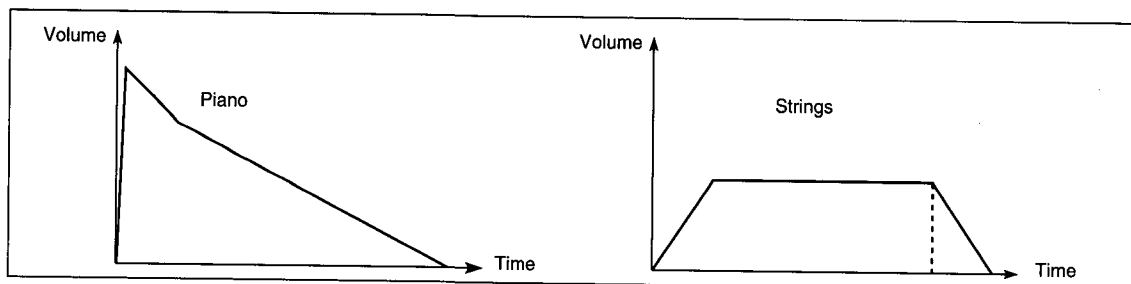

The volume changes shown in the above illustrations are called envelopes. In an N264/N364 Program, an Envelope Generator (EG) is used to create these volume-over-time changes. The VDA (Variable Digital Amplifier) uses the EG parameters to control its volume.

To hear this in action, let's edit a Program. In Program Play mode, select and play Program C01 Piano 16'. This is a typical piano sound. Press the [EDIT] button to enter Program Edit mode, then press function button [4] (or the [↑] cursor button five times) to select LCD screen 4A. The bottom line of the LCD shows the VDA1 EG parameters. Currently, the cursor is located on the AT (Attack Time) parameter, and its value is set to 00. Use the VALUE slider to adjust this value. When it reaches about 60, the piano Program starts to sound more like strings than piano.

The “>” symbol at the right-hand side of the LCD indicates that more parameters are available. Press the [←] and [→] cursor buttons to select these other parameters, and try editing their values. The VDA EG has seven parameters. The following illustration shows how they affect the envelope.

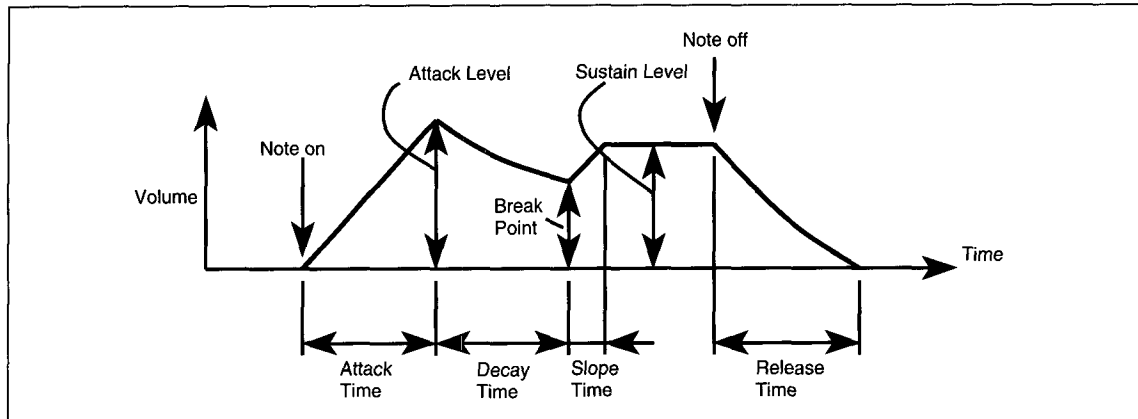

The VDA EG is a very important element for sound creation. Understanding the relationship between each parameter and the EG envelope will allow you to edit with ease.

Tone Editing

The basic tonal quality of an N264/N364 sound is determined by the waveform that you assign to an oscillator. Further tonal editing can be performed using the VDF.

1) OSC Multisounds

Musical instruments typically have only one waveform. The N264/N364, on the other hand, contains 430 different waveforms. These include acoustic instruments, electric instruments, and unique synthesizer waveforms. On the N264/N364, these waveforms are called Multisounds. N264/N364 Multisounds allow you to simulate real instruments and create original and exciting sounds of exceptional quality.

Let's listen to some Multisounds. Select Program C52 FlugelHorn, then press the [Edit] button to enter Program Edit mode. Press the [↑] cursor button once to select LCD screen 1B. The OSC1 SOUND parameter indicates that the FlugelHorn Program is currently using Multisound 151:FlugelHorn. Use the VALUE slider to select some other Multisounds. The following illustration shows LCD screen 1B, with the OSC1 SOUND parameter, and the locations of the [EDIT] button and the [↑] cursor button.

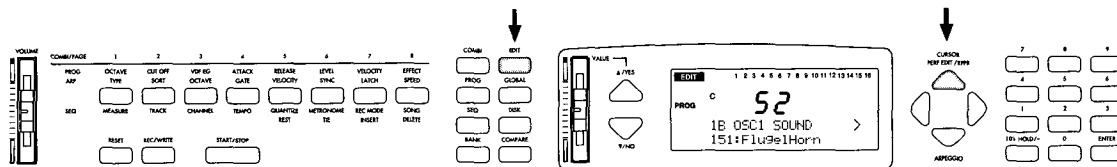

2) Using the VDF

Ultimately, the tone of a sound is determined by the chosen Multisound. However, the VDF (Variable Digital Filter) can be used to filter high frequency components from a Multisound. Let's look at this in a Program. Select Program C93 DWGS EP. This is an electric piano sound. Press the [EDIT] button to enter Program Edit mode, then press function button [3] (or the [↑] cursor button three times) to select LCD screen 3A. Currently, the cursor is located on the Fc (Cutoff Frequency) parameter and its value is set to 16. Adjust the value. As the value is raised, the sound becomes brighter. This is because the high frequency components now pass through the filter. Typically, low filter values make a sound darker, while high values make them brighter.

The following illustration shows the response curve of the filter. It is a Low Pass Filter (LPF), which means that frequencies below the cutoff frequency pass unaffected, while frequencies above, are filtered.

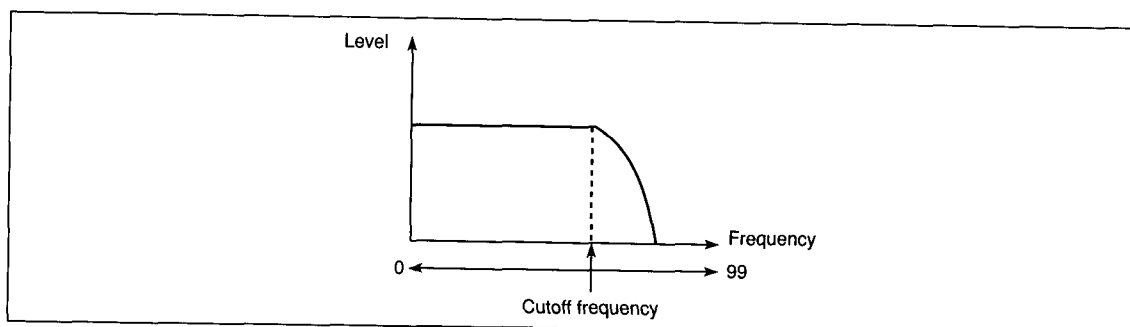

With the cutoff frequency set to 99, no high-frequency components are filtered. The filter allows you to create sounds far removed from the original Multisound.

The ">" symbol at the right-hand side of the LCD indicates that more parameters are available. Pressing the [→] cursor button twice will access the VDF1 EG parameters. The EG allows you to specify how the Cutoff Frequency will change over time. Press the [→] cursor button three times to select the Break Point parameter, and set it to -99. Then press the [→] cursor button once more and edit the other parameters. The sound will now get dark, and then become brighter.

The following illustration shows which parts of the envelope these parameters affect.

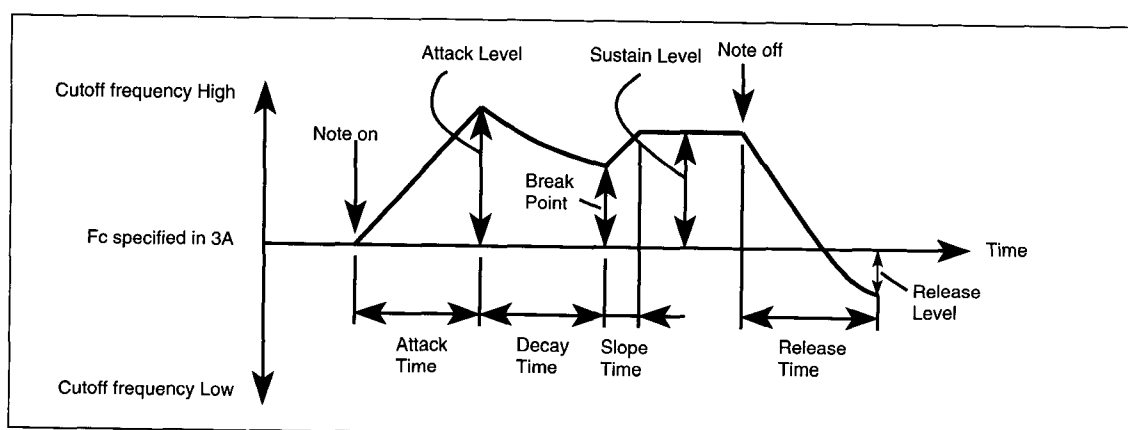

Just like a real musical instrument, the tonal quality of a Multisound changes over time. The VDF EG allows you to shape a Multisound even more, making the VDF EG an important sound building block. Unlike the VDA EG, the VDF EG has a Release Level and Time parameters, and all level parameters can be set to negative values.

A Few Words about Pitch

As well as a VDA EG and a VDF EG, the N264/N364 also has a Pitch EG. Although the pitch of an acoustic instrument will change as different notes are played, it is rare for the pitch of sounding notes to change over time. Therefore, the VDA EG and VDF EG are probably more important when creating sounds. However, the Pitch EG can be used to create unusual and special effect type sounds. It can also be used to create subtle pitch changes during the initial attack time. See "2A Pitch EG" on page 14 of the *Reference Guide*.

What is Double Mode?

Just as you can layer Programs (Timbres) in a Combination, you can layer Multisounds in a Program by assigning different Multisounds to oscillator 1 and oscillator 2. In Program Edit mode, set the OSC Mode (oscillator mode) parameter on LCD screen 1A to DOUBLE, and another set of OSC, VDF, and VDA parameters will appear.

Double mode allows you to combine two different Multisounds in a Program, or use the same Multisound twice, but vary the pitch of each to produce a thick and rich sound. The Programs that we have experimented with so far have been Single mode Programs. However, most of the N264/N364 Programs are in fact Double mode Programs.

When creating a Double mode Program, pay attention to the number of voices (simultaneous notes). The N264/N364 can play up to 64 voices (64 simultaneous notes), but since Double mode uses two tone generator elements to produce each note, the polyphony will be reduced to 32 voices.

Programs with Effects

N264/N364 Programs can be saved with their own individual effects settings. However, when a Program is used in a Combination, its effects settings are ignored, and the effects settings for that Combination are used. Bare this in mind when creating Programs that will eventually be used in Combinations.

Saving Programs

If you select another Program without saving first, your edits will be lost. If you want to save them, you must write the Program to memory. To do this, press the [REC/WRITE] button. An “Are You Sure?” message will appear. Press the [▲/YES] button to write the Program, or the [▼/NO] button to cancel. Note that if you write, you will overwrite the Program that already exists with that number. To write the Program to a different Program number or change its name, you need to enter Program Edit mode. See “8A Program Write” on page 32 of the *Reference Guide*.

Since banks C, D and GM are ROM banks, Programs cannot be saved in them. For example when saving the bank C program that was edited in the example on page 38, it must be saved in bank A or B.

Creating Original Sounds

In order to create original sounds, it is important to avoid getting caught up in established concepts. It is also important to form a clear idea of the sound that you want to create. For example, don't be limited by the names of the Multisounds. Don't think, for example, that you must put a bass envelope on a Multisound just because it's called A.Bass. Try using this bass Multisound in a high frequency range, with a typical slow strings type envelope. Truly original sounds are born out of this kind of experimentation.

The same holds true for effects processors. There's no need to believe that overdrive works only for guitars, or that the rotary speaker effect only works with organs. Don't be trapped by common sense; instead, be willing to give anything a try.

While you are experimenting, try to keep in mind the image of the sound you are creating. Even a partial image, such as that of “a soft and spacey sound”, will give you at least a few clues; e.g., it should have a slow VDA EG attack, for example, and relatively dull harmonics. With your image as a starting point, you can try VDA EG and VDF EG parameter settings, look for an appropriate Multisound, and try a number of variations. Eventually, you will come up with the original sound you're looking for—probably something better.

Chapter 9: Using the N264/N364 Sequencer

The N264/N364 is a music workstation with an on-board sequencer. This chapter will discuss some ways in which you can take advantage of the N264/N364's sequencer.

The N264/N364's sequencer is sufficiently powerful to be used as a stand-alone sequencer, and also provides the following advantages which are not often seen on other sequencers. (1) Since data is backed up even when the power is turned off, there is no danger of your losing important data by accident. Since you can begin playback immediately after turning the power on, there is no need to bother loading data from floppy disk. (2) Since patterns can be input, you can use the sequencer as a musical sketch pad to preserve your ideas and phrases, or to make rough outlines of a song.

These features can be taken advantage of in the following ways.

Using the N264/N364 as Your Main Sequencer

The N264/N364 sequencer's powerful and comprehensive functions make it ideal for use as the main sequencer at the heart of a MIDI music production system.

You can perform real-time or step-time recording for tracks and patterns. For more details about the sequencer, see page 93 "Sequencer mode" and page 113 "Sequencer Edit mode" of the *Reference Guide*.

Using Standard MIDI Files

You may need to transfer your song data from a computer sequencer to the N264/N364. You can do this by saving your songs as Standard MIDI Files (SMF). The N264/N364 can then read the SMF song data straight off an MS-DOS format floppy disk.

To read an SMF file, press the [DISK] button to enter Disk mode, then select LCD screen 5A. Insert the floppy disk that contains the SMF song data. The message "Directory OK?" will appear. Press the [▲/YES] button. The following illustration shows the location of the [DISK] button, the [▲/YES] button, and function button [5] that is used to access LCD screen 5A.

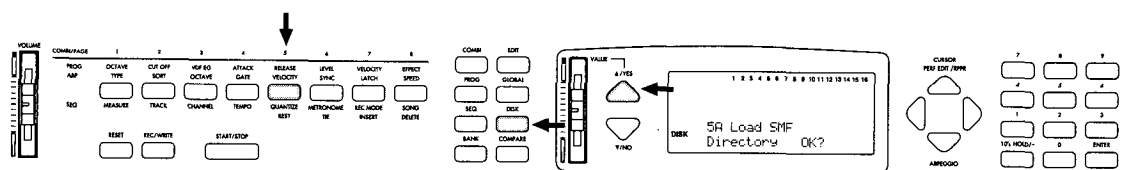

Use the VALUE slider or the [▲/YES] and [▼/NO] buttons to select the SMF file that you want to load, then press the [→] cursor button to select the destination song into which the data should be loaded. Press the [→] cursor button again to move the cursor to "OK?", then press the [▲/YES] button. The following illustration shows LCD screen 5A with the Destination Song parameter.

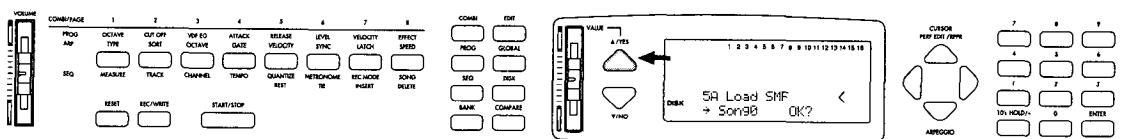

The message "Are You Sure OK?" will appear. Press the [▲/YES] button to load, or the [▼/NO] button to cancel. While loading, the message "Now Loading..." will be shown. When loading is complete, the message "Completed" will appear.

To play the loaded SMF data, press the [SEQ] button to enter Sequencer mode. Then press function button [8], and use the VALUE slider or the [▲/YES] and [▼/NO] buttons to select the song that you chose as the loading destination.

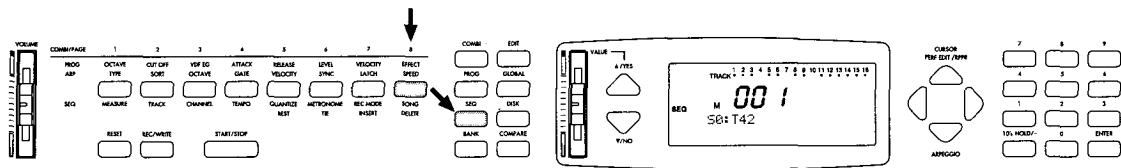

Press the [START/STOP] button, and the selected song will begin playing back. During playback, pressing the [START/STOP] button will pause playback, and pressing it again will resume playback from the paused location. To return to the beginning of the song, stop the playback and press the [RESET] button.

Using the N264/N364 Sequencer as a Musical Sketch Pad

Not many software based sequencers allow pattern recording. Even some stand-alone sequencers do not have pattern recording functions. The N264/N364 not only allows pattern recording, but all sequencer data is continuously backed up, so you don't have to bother with floppy disks. These features are extremely useful when it comes to capturing ideas, which can easily be forgotten in the time it takes to load a floppy disk. Patterns allow you to experiment with song development by stringing various patterns together, listening to the result, then deciding on the best arrangement. See "5A Real-Time Pattern Record/Edit" on page 143 of the *Reference Guide*.

Chapter 10: Playing GM Songs

The N264/N364 can playback GM compatible songs in several ways. The data can be played back on an external sequencer, and the GM-compatible messages transmitted from the sequencer can be received at MIDI IN and played by the N264/N364 in realtime. Alternatively, the GM compatible data can be received by the N264/N364 as a MIDI dump, or can be loaded from floppy disk as a Standard MIDI File into the N264/N364's sequencer, and then played.

To receive GM song data and play it in realtime, make connections as shown in the following illustration.

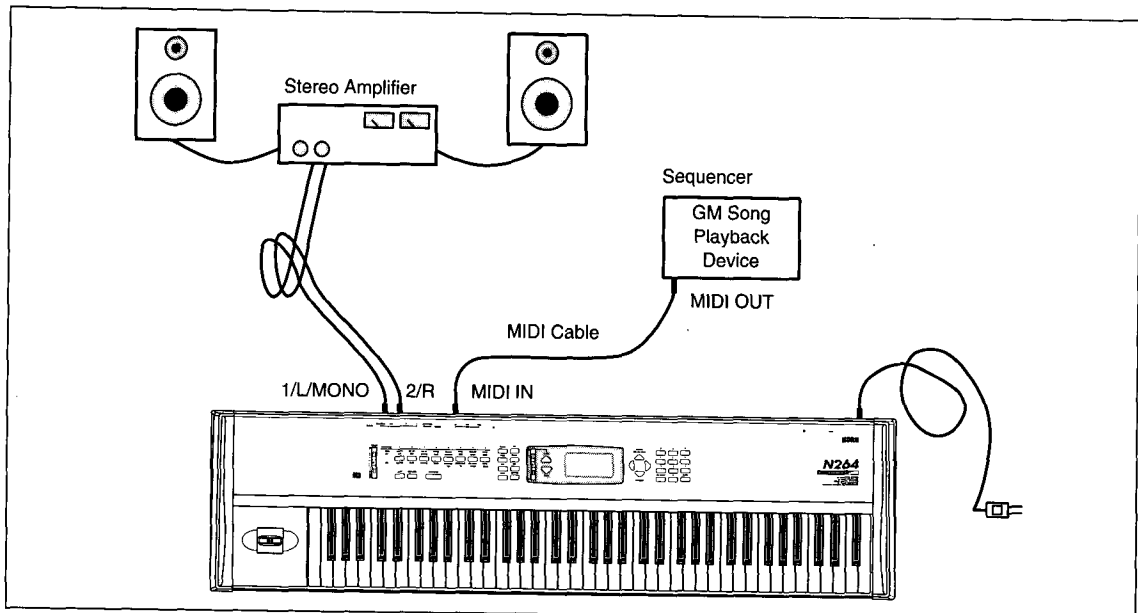

If the beginning of the GM song data contains a GM System On message, the N264/N364 will receive this message and automatically select song 9 and initialize it for GM.

If the GM song data does not contain a GM System On message, you must first press the [SEQ] button to enter Sequencer mode, and then press function button [8] to access the Song Select display. Then use the VALUE slider or the [▲/YES] and [▼/NO] buttons to select the song that you wish to initialize for GM compatibility.

Next, press the [EDIT] button to enter Sequencer Edit mode, press function button [8], and press the [↑] button five times to access [8F] Set To GM. The display will ask "OK?", so if you wish to initialize the selected song, press the [▲/YES] button. Then start the GM compatible data playing on the connected device.

If the data is not played back correctly, check that the Global mode parameters are set as follows.

LCD Screen	Parameter	Value
1B Transpose	Transpose	+00
1C Keyboard After Touch & Velocity Response Curve	Velocity Response	3
	After Touch Response	3
2A Keyboard Scale	Scale Type	Equal Temperament
3B Note Receive Filter	Note Receive Filter	ALL
3C MIDI Filter1	Program Change Filter	ENA, NUM (set by listening and comparing)
	After Touch Filter	ENA
3D MIDI Filter2	MIDI Controller Filter	ENA
	System Exclusive Filter	DIS

About GM Song Data

Usually, each track of a GM song contains a MIDI Program Change message. This automatically ensures that a piano sound Program will be selected for the track which plays the piano part, and a bass Program for the bass track, etc. Track 10 always uses a drum Program.

Chapter 11: Arpeggio mode

About Arpeggio mode

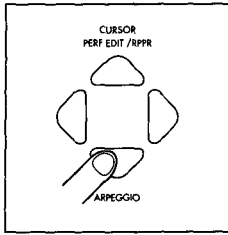

In Program Play, Combination Play, and Sequencer modes, press the [↓] button to enter Arpeggio mode.

The “<>” in the display will blink alternately in time with the tempo of the arpeggio. When you play the keyboard in this page, arpeggio play will begin automatically. The sound that is heard at this time will depend on the Play mode (PROG, COMBI, SEQ) that you were in when you pressed the [↓] button.

Each time you press a key, the synthesizer will normally produce a note corresponding to that key. However in Arpeggio mode, the two or more keys that you hold down will sound one by one in sequence.

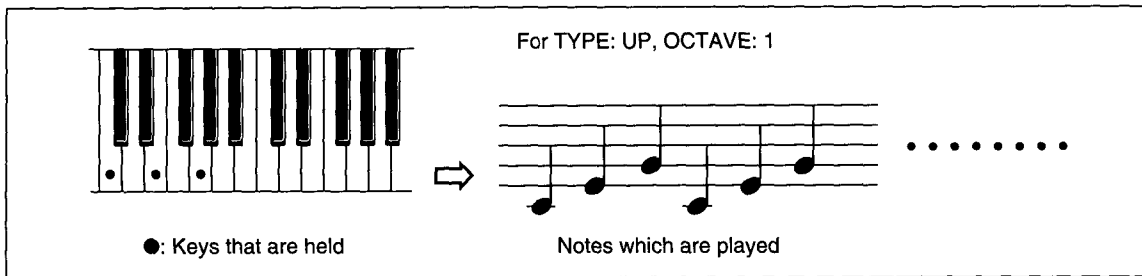

Of the keys that you hold down simultaneously, the first 10 will be used to play the arpeggio, and the 11th and additional notes will be ignored.

The key that is first pressed from a condition of no keys being pressed will be referred to here as the “first key.”

Note data for each note of the arpeggio will be transmitted from MIDI OUT. Note data received at MIDI IN will not play an arpeggio, but will be sounded by the internal tone generator just as they are.

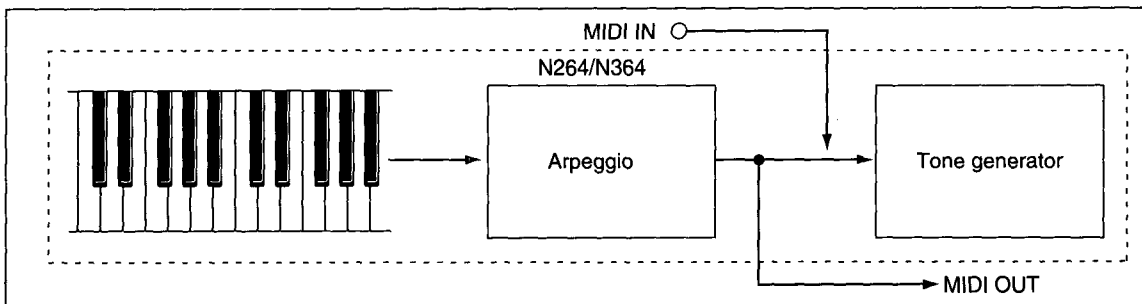

If you have entered Arpeggio mode from Combination Play or Sequencer mode, keys that are pressed outside the Key Window area will be included in the arpeggio play pattern, but will not be sounded or transmitted via MIDI.

For example if the Key Window is set to C4–C5, the TYPE=UP, and OCTAVE=3, holding down the G3 and C4 keys will produce a repeating arpeggio consisting of “silence → C4 → G4 → C5 → silence → silence”.

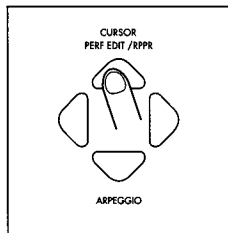
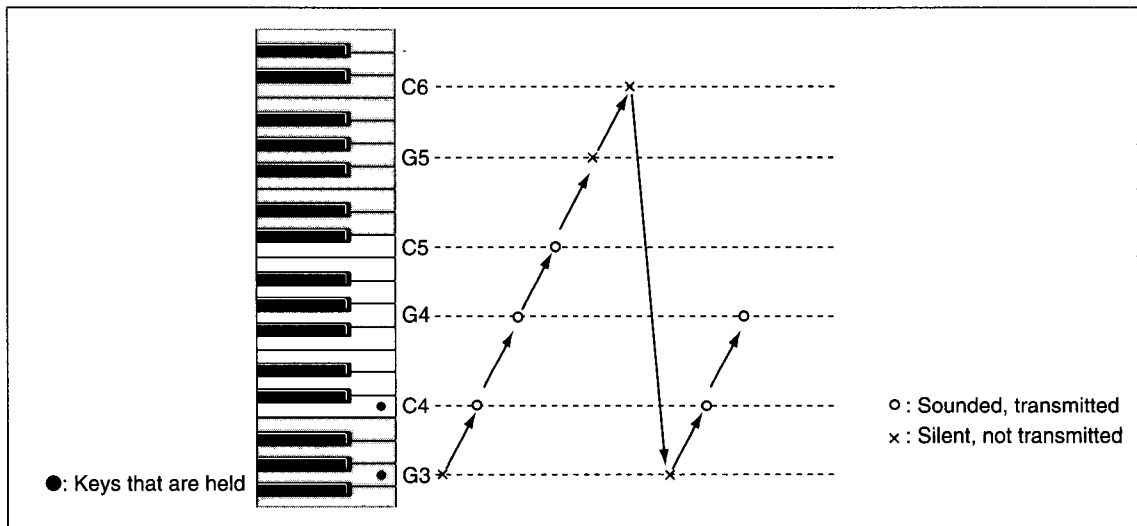

Pressing the [\uparrow] button will exit Arpeggio mode and return to the previous mode.

Editing in Arpeggio mode

To make Arpeggio mode settings, use the function buttons [1]–[8] to select a parameter, and use the [\blacktriangle /YES] and [\blacktriangledown /NO] buttons or the VALUE slider to input the value. The settings are remembered without the Write operation, and are backed up even when the power is turned off. The arpeggio settings you made will still be available the next time you turn the power on.

Function buttons [1]–[8] access the following functions.

- [1]: TYPE
- [2]: SORT
- [3]: OCTAVE
- [4]: GATE
- [5]: VELOCITY
- [6]: SYNC
- [7]: LATCH
- [8]: SPEED

For the parameters and functions of Arpeggio mode, see chapter 8 of the *Reference Guide*.

Only for the special case in which you move from Program Play mode to Arpeggio mode, you can edit the sound while playing an arpeggio. Double-click (rapidly press twice) a function button [1]–[8], and the Performance Edit parameter assigned to that button will be selected for editing. A single click will select the Arpeggio parameter.

Techniques for arpeggio playing

- Since the arpeggio will begin playing from the keyboard pitch of the first key, simply playing a chord without thought may cause the arpeggio to start from an unexpected pitch. The key from which you want the arpeggio to start must be consciously played first.
- The arpeggio pattern is specified by the Type, Sort, and Octave parameters, and the mode of playing is specified by the Sync, Latch, and Speed parameters. Individual notes will sound as specified by the Gate and Velocity parameters.

- In Program Play mode, you can use Performance Editing to modify the sound while the arpeggio is playing. For example you could modify the cutoff frequency as the arpeggio plays to modify the tone. See the above item “Editing in Arpeggio mode.”
- If Latch is on, the arpeggio will continue playing even when you release the notes. In this case if you also turn Sort off, the notes will be played in the order in which they were pressed. If you once again press a key that was already pressed, it will be used a second time in the arpeggio, allowing you to use the same note multiple times. For example if you press C → G → E, and then re-play only G (while continuing to hold the other keys), the arpeggio will be played as C → G → E → G. However a maximum of 10 keys can be used simultaneously for arpeggio play.

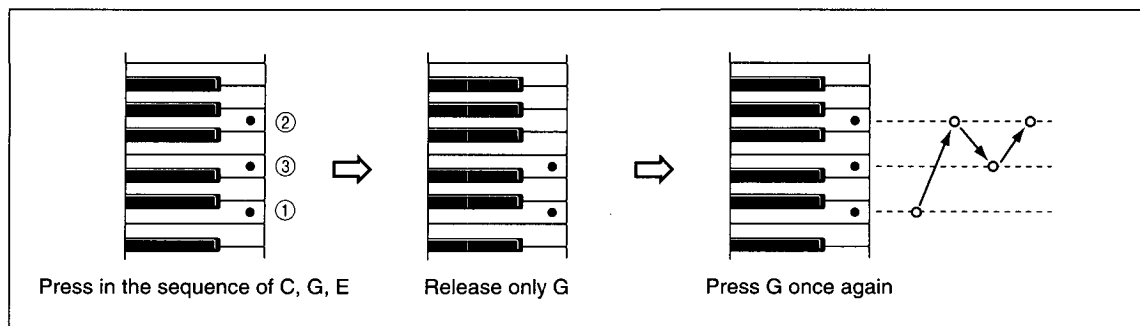

Recording arpeggio playing

- Arpeggio playing can be recorded onto the sequencer.
 - 1) As for normal recording, make the necessary settings in Sequencer mode.
 - 2) Press the [↓] button to enter Arpeggio mode.
 - 3) As for normal recording, press the [REC] button and the [START/STOP] button to begin recording.
 - 4) Press the [START/STOP] button once again to stop recording.

Since the song and the arpeggio will play at their own tempo, it is in principle not possible to synchronize them. However by setting the song tempo and the arpeggio tempo to the same setting during recording, and by setting Quantize (function button [5]) to [♪] or [♩], you can record the arpeggio at timing that matches the song. However, be aware that if the arpeggio extends for many measures, the timing may drift.

- Arpeggio play is not synchronized to the sequencer song or to MIDI timing clock messages.
- If you wish to record arpeggio play into a pattern,
 - 1) Use the above method to record the arpeggio into a song.
 - 2) Use the Get From Track function (Sequencer Edit mode [6B]) to place the musical data into a pattern. (See page 148 of the *Reference Guide*.)
- If you wish to use an arpeggio in Pattern Play,
 - 1) Use the above method to place the arpeggio into a pattern.
 - 2) In RPPR mode 10–2 PAT, assign that pattern to the keyboard. (See page 161 of the *Reference Guide*.)

In either case, be aware that unless the playback track matches the track during recording or the track which was assigned to the keyboard (the Program selection, etc.), the playback result will not be the same.

Chapter 12: Realtime Pattern Play/Recording mode

About Realtime Pattern Play/Recording mode

You can assign sequencer patterns to individual notes of the keyboard, and playback these patterns in realtime by pressing a note (this is referred to as Pattern Play). The result can also be recorded.

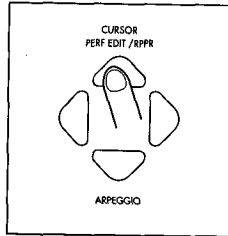

In Sequencer mode, press the [↑] button to enter Realtime Pattern Play/Recording mode.

The display will indicate "<>". Since songs are in common between this mode and Sequencer mode, you can use both modes to construct a single song.

To use Pattern Play, you will assign a pattern to each key C#2–C7, and make track settings.

To stop Pattern Play, press C2 (or E1–C2 on the N264). On the N264, keys C#7–G7 are not used for Pattern Play, and will produce their normal keyboard pitch.

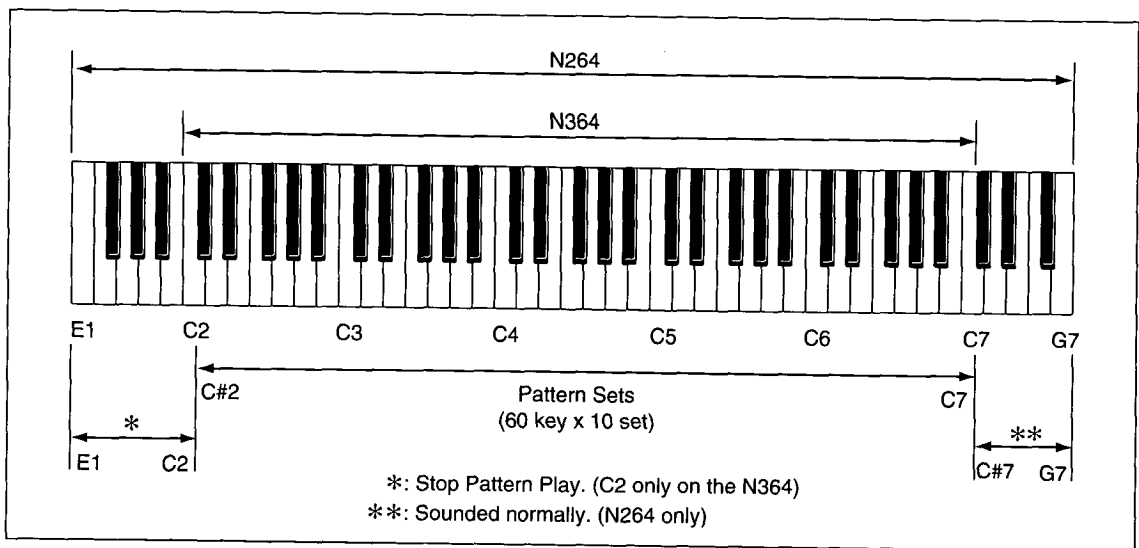

Ten sets of Pattern Play settings can be stored in internal memory, with each set containing settings for the 60 keys C#2–C7. These are referred to as Pattern Sets.

When you play the keyboard, the pattern will playback on the track specified for that key (See "10-3 TRK (Track)" on page 161 of the *Reference Guide*). The following illustration will help you understand this.

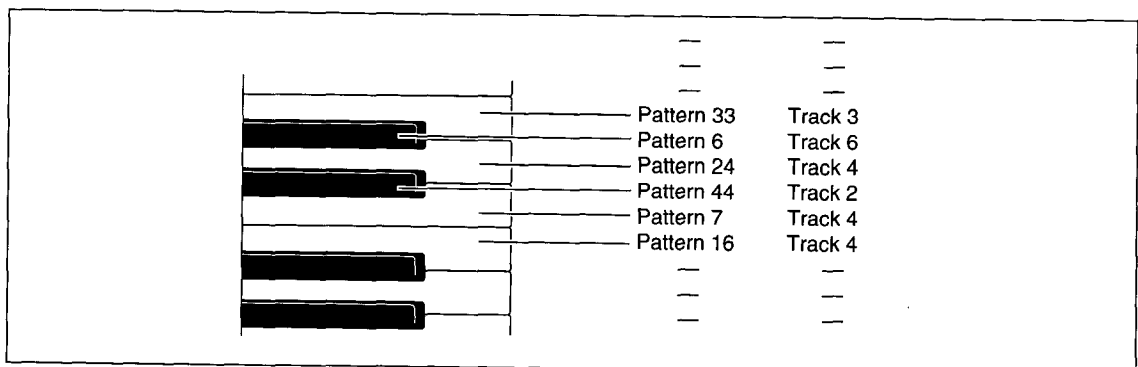

The parameters of Realtime Pattern Play/Recording are set in pages 9–13, as shown in the following table. The same parameters as in Sequencer mode are arranged to the left of these, and can be selected using the [←] and [→] buttons.

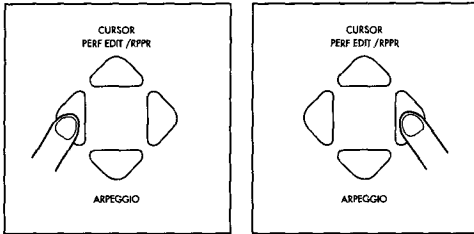
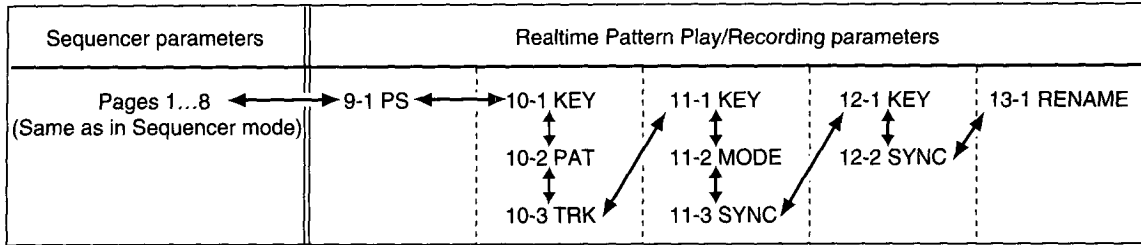

When you enter this mode, PS (Pattern Set select) will be selected, so you can immediately choose a Pattern Set. Then use the [←] button to access the main sequencer parameters, or use the [→] button to access the Realtime Pattern Play/Recording parameters.

The main sequencer parameters (pages 1–8) can also be accessed by the function buttons.

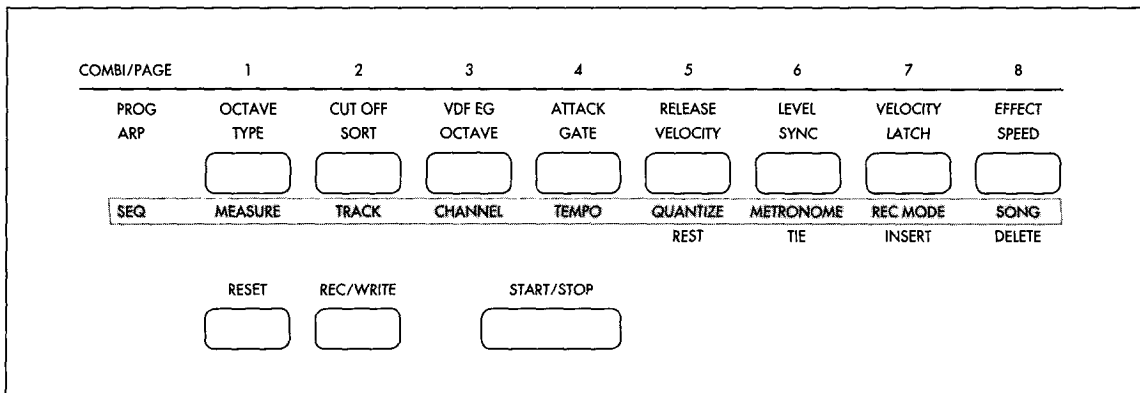

- If you wish to initialize the Pattern Set setting, load the initialization file INITIAL.PST from the included floppy disk.

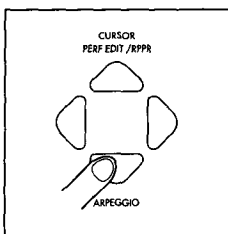

Press the [↓] button to exit Realtime Pattern Play/Recording mode.

For details on the Realtime Pattern Play/Recording parameters and functions, see chapter 9 of the Reference Guide.

Realtime Pattern Play playing techniques

Prepare the song and patterns beforehand in Sequencer mode and Sequencer edit mode. In Sequencer mode, you can press [↑] to enter Realtime Pattern Play/Recording mode. Press the key that corresponds to the pattern you wish to play, and the assigned pattern will playback.

For a key with a Mode setting of Endless, the pattern will continue playing even after you release the key. To stop the pattern playback, press that key once again or press C2 (on the N264, C2 or any lower key).

- Switching to a different Pattern Set

When you enter Realtime Pattern Play/Recording mode, 9-1 PS (the parameter which selects the Pattern Set) will be selected, so you can select a Pattern Set immediately.

If you are already in Realtime Pattern Play/Recording mode and a different parameter is selected, use the [←] [→] buttons to select PS.

- Modifying the settings (Pattern, Track, or Mode, etc.) of a specific key
 - 1) Select 10-1 KEY (the parameter which selects the key to edit). If you have just entered Realtime Pattern Play/Recording mode, pressing the [→] button once will select this parameter.)
 - 2) Select the key C#3-C7 that you wish to edit. If you press a key, it will automatically be selected.
 - 3) Use the [→] button to select the desired parameter. The following five parameters can be set for each key.
 - PAT (select pattern)
 - TRK (select track)
 - MODE (set mode)
 - SHFT (set amount of shift)
 - SYNC (synchronization setting)

Recording procedure

You can record Realtime Pattern Play to the sequencer. The pattern playback data will be recorded to the selected track as notes.

- Recording procedure
 - 1) As for normal recording, make the necessary settings in Sequencer mode.
 - 2) Press the [↑] button to enter Realtime Pattern Play/Recording mode.
 - 3) As for normal recording, use the [REC/WRITE] button and the [START/STOP] button to begin recording.
 - 4) To stop recording, press the [START/STOP] button once again.

If you wish to record Realtime Pattern Play together with previously recorded musical data, use the function button [5] Quantize function to set the resolution beforehand.
- If you wish to record Realtime Pattern Play to a single track (Single Track Recording), use Track (function button [2]) to select the recording track in the same way as when recording a song.

Of the patterns assigned to the keys, Realtime Pattern Play will be recorded for those patterns whose track number matches the recording track number.

Set the recording track to match the track of the keys that contain the patterns you wish to record.
- If you wish to initialize the Pattern Set settings, load the INITIAL.PST initialization data from the included floppy disk.

Note: For Single Track Recording, only the one track that is selected by Track (function button [2]) will be recorded, even if two or more tracks are used for Realtime Pattern Play. If you wish to record two or more tracks simultaneously, turn Multi REC (function button [7]) ON, and set Track Mode (use function button [3] to select, and see page 108 of the Reference Guide) to REC for the tracks that you wish to record.

Note: Even when the parameters are the same as in Sequencer mode (pages 1-8), the display of "< >" indicates that you are in Realtime Pattern Play/Recording mode. In this case, be aware that different data will be recorded than when in normal Sequencer mode.

Playing techniques in Realtime Pattern Play/Recording

- Keys whose Sync parameter is set to BEAT or MEAS will synchronize to the first key, so pay attention to the Sync setting of the key that you use as the first key, and how you play it.
- If you wish to synchronize Pattern Play (when Sync is BEAT, MEAS, or SEQ), pressing the key slightly earlier than the beat or measure will cause the timing to be aligned accurately. Also, even if the timing at which you press the key is later than the beat or measure location, it will be considered that you pressed the key at that beat or measure as long as the delay was no more than [♪], and the beginning of the pattern will be compressed for the duration of this delay.
- Keys whose PAT setting is OFF can be played normally, but rather than allowing these keys to be scattered across the keyboard, it is a good idea to use a specific area for normal playing. An area that will not be used for normal playing can be set aside for Pattern Play, and the rest of the keys can be used for normal playing (PAT: OFF).

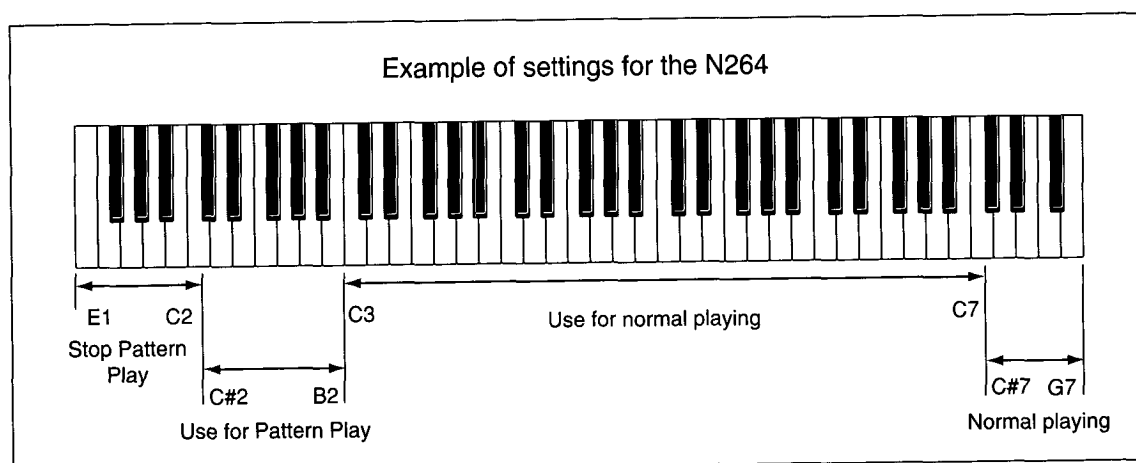

If you wish to include control data in a pattern, you must be sure that the pattern will return the parameters to their normal value. Otherwise, modulation etc. will continue to be applied after the pattern ends. Also, even if the normal values are restored before the end of the pattern, be aware that similar problems will occur if you halt playback in the middle of the pattern (by playing the pattern with Mode= MANUAL, or by using the C2 key). However, the following control data will be automatically restored to the reset values when the pattern ends or when pattern playback is halted.

Controller	Reset value	
Pitch MG (CC#01)	: 00 (00)	CC: MIDI Control Change
Cutoff MG (CC#02)	: 00 (00)	
Expression (CC#11)	: 127 (Max)	
Damper (CC#64)	: 00 (Off)	
Release Time (CC#71)	: 64 (Initial)	
Attack Time (CC#72)	: 64 (Initial)	
Brightness (CC#73)	: 64 (Initial)	
After Touch	: 00 (00)	
Bender	: 8192 (Center)	

However, Volume (CC#07), Panpot (CC#10), and Program Change will not be reset.

- If you have created a Pattern Set for use together with a specific song, use the [←] and [→] buttons to choose Song Select, and select the appropriate song.
- Pattern Play will be synchronized to song playback for keys whose Sync parameter is set to SEQ. However when song playback is stopped, Pattern Play will begin when you press the key, since there is no measure timing to which the pattern can synchronize (the same operation as when Sync is OFF). If you want a key that is set to Sync:SEQ to synchronize with the song, you must first start the song.
- When Pattern Play is recorded, keys that were pressed during the pre-count will start when recording begins.
- When Pattern Play is recorded, the synchronization may deviate slightly from the song, so it is a good idea to make an appropriate Quantize setting (function button [5]).

- When creating your own Realtime Pattern Play song, pay attention to the type of Program that you assign to each track. For example if you always use a bass sound for track 1 and drums for track 10, the pattern will playback with appropriate sounds even if it is played as part of a different Pattern Set. See the demo song settings for ideas.

Chapter 13: Data Compatibility

N264, N364

The N264 and N364 are compatible with each other via floppy disk or MIDI data dump, and data can be exchanged by these methods and used as it is.

X2, X3, X3R

The N264/N364 is compatible via floppy disk and MIDI data dump with the X2, X3 and X3R, and the data can be used as it is. After the data is loaded, the operation may differ in some cases, but this is due to differences between models in the number of multisounds, the effect placement, the presence or absence of a damper pedal, and also due to differences in transpose, velocity curve, and aftertouch curve. However the data values themselves are not changed during loading, and are simply performing slightly differently because of the different model of instrument. If the data is re-loaded into the original instrument, it will produce the original results.

Since the X2, X3 and X3R do not have Realtime Pattern Play/Recording functionality, Pattern Sets will not be transmitted or received between these instruments.

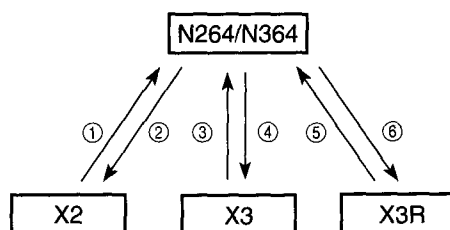

- ① Compatible.
- ② Multisounds #341 and above will be displayed as "Invalid No." and will not sound.
- ③ Compatible.
- ④ Multisounds #340 and above will be displayed as "Invalid No." and will not sound. Effect Placement settings of Serial Sub or Parallel Sub will be converted to Parallel 3.
- ⑤ Transpose, velocity curve, and aftertouch curve will operate according to the N264 and N364 settings.
- ⑥ The Global parameter Damper Polarity will be ignored. Transpose, velocity curve, and aftertouch curve will operate according to the X3R settings. Multisounds #340 and above will be displayed as "Invalid No." and will not sound.

The N264/N364 can transmit and receive Pattern Set data as a MIDI data dump. When transmitting All Data in Global mode P5, first transmit All Data in the same format as the X2/X3/X3R, and when this transmission is completed, transmit the Pattern Set data. If transmitted data is divided in this way, All Data from the N264/N364 can be received by the X2/X3/X3R.

When ALL DATA is loaded from an X2/X3/X3R floppy disk, the display will indicate "No File" at the end of the loading operation. This is because Pattern Sets (data unique to the N264/N364) were not found. Program/Combination and sequencer data etc. has been loaded correctly.

i1, i2, i3, i4S

When User Programs (64 programs of bank D + sound data for DRUM, PROG7 and 8) created on the Korg i1, i2, i3 or i4S is loaded into the N264/N364 in Disk mode "Load All" or "Load P/C/G", the 66 programs of the i1, i2, i3 or i4S will be loaded into the N264/N364 bank A numbers 00-65. At this time, the Global mode data of the i2/i3 will not be loaded (only drum kits 1 and 2 will be loaded).

i1, i2, i3, i4S		N264/N364
Bank —D11-88	↔	Bank — A00-63
DRUM PROG 7	↔	Bank — A64
DRUM PROG 8	↔	Bank — A65

(i5S and i5M data is not compatible with the N264/N364.)

Chapter 14: Voice Name List

MULTISOUND

000 A.Piano 1	060 Over Drive	120 Pole	180 White Pad	240 Tite HH NT	300 Mute Conga
001 A.Piano1LP	061 OverDrv LP	121 Pole LP	181 Ether Bell	241 Bell Ride	301 Tabla 1
002 A.Piano 2	062 OverDrv F4	122 Tubular	182 E.Bell LP	242 Ping Ride	302 Tabla 2
003 E.Piano 1	063 MuteDstGtr	123 Split Drum	183 Mega Pad	243 Timpani	303 Maracas
004 E.Piano1LP	064 MtDstGtr V	124 Split Bell	184 Spectrum 1	244 Timpani LP	304 SynMaracas
005 E.Piano 2	065 PowerChord	125 Flute	185 Spectrum 2	245 Cabasa	305 SynMarcsNT
006 E.Piano2LP	066 PowerChd V	126 Pan Flute	186 Stadium	246 Cabasa NT	306 MuteTriang
007 Soft EP	067 OverDvChrd	127 PanFluteLP	187 Stadium NT	247 Agogo	307 OpenTriang
008 Soft EP LP	068 Gtr Slide	128 Shakuhachi	188 BrushNoise	248 Cow Bell	308 Guiro
009 Hard EP	069 GtrSlide V	129 ShakhachLP	189 BruNoiseNT	249 Low Bongo	309 Guiro LP
010 Hard EP LP	070 Sitar 1	130 Bottle	190 Steel Drum	250 Claves	310 Scratch Hi
011 PianoPad 1	071 Sitar 2	131 Recorder	191 SteelDrmLP	251 Timbale	311 ScratchHiNT
012 PianoPad 2	072 Sitar 2 LP	132 Ocarina	192 BrushSwirl	252 WoodBlock1	312 Scratch Lo
013 Clav	073 Santur	133 Oboe	193 Belltree	253 WoodBlock2	313 ScratchLoNT
014 Clav LP	074 Bouzouki	134 EnglishHrn	194 BelltreeNT	254 WoodBlock3	314 ScratchDbl
015 Harpsicord	075 BouzoukiLP	135 Eng.HornLP	195 BeltreV NT	255 Taiko Hit	315 ScratDblNT
016 HarpsicdLP	076 Banjo	136 BasoonOboe	196 Tri Roll	256 Syn Claves	316 Mini 1a
017 PercOrgan1	077 Shamisen	137 BsonOboeLP	197 TriRoll NT	257 Melo Tom	317 Digital 1
018 PercOrg1LP	078 Koto	138 Clarinet	198 Telephon	258 ProccesTom	318 VS 102
019 PercOrgan2	079 Uood	139 ClarinetLP	199 TelephonNT	259 Syn Tom 1	319 VS 48
020 PercOrg2LP	080 Harp	140 Bari Sax	200 Clicker	260 Syn Tom 2	320 VS 52
021 Organ 1	081 MandlinTrm	141 Bari.SaxLP	201 Clicker NT	261 VocalSnare	321 VS 58
022 Organ 1 LP	082 A.Bass 1	142 Tenor Sax	202 Crickets 1	262 Zap 1	322 VS 71
023 Organ 2	083 A.Bass1 LP	143 T.Sax LP	203 Crickets1NT	263 Zap 2	323 VS 72
024 Organ 2 LP	084 A.Bass 2	144 Alto Sax	204 Crickets 2	264 Fret Zap 1	324 VS 88
025 Organ 3	085 A.Bass2 LP	145 A.Sax LP	205 Crickets2NT	265 Fret Zap 2	325 VS 89
026 Organ 4	086 E.Bass 1	146 SopranoSax	206 Magic Bell	266 Vibla Slap	326 13-35
027 Organ 5	087 E.Bass1 LP	147 S.Sax LP	207 Sporing	267 Indust	327 DWGSOrgan1
028 RotaryOrg1	088 E.Bass 2	148 Tuba	208 Rattle	268 Thing	328 DWGSOrgan2
029 RotaryOrg2	089 E.Bass2 LP	149 Tuba LP	209 Kava 1	269 Thing NT	329 DWGS E.P.
030 PipeOrgan1	090 Pick Bass1	150 Horn	210 Kava 2	270 FingerSnap	330 Saw
031 PipeOrg1LP	091 PicBass1LP	151 FlugelHorn	211 Fever 1	271 FingSnapNT	331 Square
032 PipeOrgan2	092 Pick Bass2	152 Trombone 1	212 Fever 2	272 Tambourine	332 Ramp
033 PipeOrg2LP	093 Fretless	153 Trombone 2	213 Zappers 1	273 Hand Clap	333 Pulse 25%
034 PipeOrgan3	094 FretlessLP	154 Trumpet	214 Zappers 2	274 HandClapNT	334 Pulse 8%
035 PipeOrg3LP	095 Slap Bass1	155 Trumpet LP	215 Bugs	275 Gun Shot	335 Pulse 4%
036 Musette	096 Slap Bass2	156 Mute TP	216 Surfy	276 Castanet	336 Syn Sine
037 Musette V	097 SlpBass2LP	157 Mute TP LP	217 SleighBell	277 CastanetNT	337 Sine
038 Bandneon	098 Slap Bass3	158 Brass 1	218 Elec Beat	278 Snap	338 DJ Kit 1
039 BandneonLP	099 SynthBass1	159 Brass 1 LP	219 Idling	279 Snap NT	339 DJ Kit 2
040 Accordion	100 SynBass1LP	160 Brass 2	220 EthnicBeat	280 Gt Scratch	340 M1 Piano
041 AcordionLP	101 SynthBass2	161 Brass 2 LP	221 Taps	281 Side Stick	341 Organ 6
042 Harmonica	102 SynBass2LP	162 StringEns.	222 Tap 1	282 SideStikNT	342 Organ 6 LP
043 G.Guitar	103 House Bass	163 StrEns. V1	223 Tap 2	283 TimbleSide	343 Super BX-3
044 G.GuitarLP	104 FM Bass	164 StrEns. V2	224 Tap 3	284 TimblSidNT	344 SuperBX3LP
045 F.Guitar	105 FM Bass LP	165 StrEns. V3	225 Tap 4	285 Syn Rim	345 Stick
046 F.GuitarLP	106 Kalimba	166 AnaStrings	226 Tap 5	286 Syn Rim NT	346 Tambura
047 F.Guitar V	107 Music Box	167 PWM	227 Orch Hit	287 Open HH	347 Tambura LP
048 A.Gtr Harm	108 MusicBoxLP	168 Violin	228 SnareRI/Ht	288 OpenSyn HH	348 SynthBass3
049 E.Guitar 1	109 Log Drum	169 Cello	229 Syn Snare	289 CloseSynHH	349 RezBass 1
050 E.Guitr1 V	110 Marimba	170 Cello LP	230 Rev Snare	290 Sagat	350 RezBass 2
051 E.Guitar 2	111 Xylophone	171 Pizzicato	231 PowerSnare	291 Sagat NT	351 MiniBass
052 E.Guitar 3	112 Vibe	172 Voice	232 Orch Perc	292 Sagatty	352 SynMallet
053 MuteGuitar	113 Celesta	173 Choir	233 Crash Cym	293 Sagatty NT	353 Glocken 2
054 Funky Gtr	114 Glocken	174 Soft Choir	234 CrashCymLP	294 JingleBell	354 FingCymbal
055 FunkyGtr V	115 BrightBell	175 Air Vox	235 CrashLP NT	295 Taiko	355 FingCymbNT
056 E.Gtr Harm	116 B.Bell LP	176 Doo Voice	236 China Cym	296 Slap Bongo	356 Gong
057 DistGuitar	117 Metal Bell	177 DooVoiceLP	237 Splash Cym	297 Open Conga	357 Gong LP
058 Dist GtrLP	118 M.Bell LP	178 Syn Vox	238 Orch Crash	298 Slap Conga	358 HardFlute1
059 DistGuitrV	119 Gamelan	179 Syn Vox LP	239 Tite HH	299 Palm Conga	359 HardFlute2

360 Tin Flute	372 Windbell	384 Flute FX	396 Boogeta	408 Baya	420 Growl!
361 TinFluteLP	373 WindbellLP	385 FluteFX LP	397 MouthHarp1	409 Drop	421 Growl! NT
362 BrightHorn	374 WindbellNT	386 Flutter	398 MouthHrp1A	410 CorkPop	422 Monkey 1
363 Glass Vox	375 Waterphone	387 Flutter LP	399 MouthHarp2	411 Pull 1	423 Monkey 2
364 Synth Pad	376 WaveSweep	388 Cast Roll	400 MouthHrp2A	412 Pull 1 NT	424 MouthHarps
365 Synth PadA	377 WaveSweepA	389 CastRollINT	401 ChromRes	413 Pull 2	425 Loopey
366 Ghostly	378 WaveSweepB	390 Harp Up	402 WahFuzz	414 Pull 2 NT	426 ClockWorks ®
367 WhiteNoise	379 Lore	391 Harp Up LP	403 OilDrum	415 SolidHit	427 MusicaLoop ®
368 WhiteNoiNT	380 Lore NT	392 Jung Gliss	404 Fist	416 HandDrill	428 Manimals ®
369 Jetstar	381 Tron Up	393 JungGlissLP	405 Stick Hit	417 HandDriINT	429 Down Lo ®
370 Jetstar LP	382 Tron Up LP	394 MalletLoop	406 Metal Hit	418 Scratch a	
371 JetstarLPNT	383 Tron Up NT	395 MalletLPNT	407 GlassBreak	419 Samurai!	® : with Pan

DRUMSOUND

000 Fat Kick	036 Side Stick	072 Slap Conga	108 FingerSnap	144 Stadium	180 Sword
001 Rock Kick	037 Syn Rim	073 Palm Conga	109 Timbales	145 BrushNoise	181 BISS
002 Ambi.Kick	038 VocalSnr 1	074 Mute Conga	110 Kalimba 1	146 Gt Slide	182 BOOFN
003 Crisp Kick	039 VocalSnr 2	075 Baya 1	111 Kalimba 2	147 Bell Tree	183 BOOGETA
004 Punch Kick	040 Crash Cym	076 Baya 2	112 Marimba 1	148 Tri Roll	184 CHLACK
005 Real Kick	041 Crash LP	077 Tabla 1	113 Marimba 2	149 JingleBell	185 COOSH
006 Dance Kick	042 China Cym	078 Tabla 2	114 Marimba 3	150 Whistle S	186 COUGH
007 Gated Kick	043 China LP	079 Tabla 3	115 Marimba 4	151 Whistle L	187 ISSH
008 ProcesKick	044 Splash Cym	080 Maracas	116 Xylofon 1	152 Timpani	188 POOM
009 Metal Kick	045 Splash LP	081 Cabasa	117 Xylofon 2	153 Taiko Hi	189 Uhhh!
010 Syn Kick 1	046 Orch Crash	082 SynMaracas	118 Xylofon 3	154 Taiko Lo	190 Samurai!
011 Syn Kick 2	047 OrchCym LP	083 MuteTriang	119 Log Drum 1	155 Music Box1	191 Growl!
012 Syn Kick 3	048 Tite HH	084 OpenTriang	120 Log Drum 2	156 Music Box2	192 Monkey 1
013 Orch B.Drm	049 Open HH	085 Tambourine	121 Log Drum 3	157 Clicker 1	193 Monkey 2
014 Snare 1	050 Pedal HH	086 Cowbell	122 Log Drum 4	158 Clicker 2	194 Glocken 2
015 Snare 2	051 CloseSynHH	087 SynCowbell	123 Log Drum 5	159 Clicker 3	195 Glocken 3
016 Snare 3	052 Open SynHH	088 R-Timbal	124 Snap	160 Crickets	196 FingCymbal
017 Snare 4	053 Sagat	089 Hi Timbal	125 BrightBell	161 Orch Hit	197 Gong Hi
018 PicloSnare	054 Ride Edge	090 Lo Timbal	126 Metal Bell	162 Metronome1	198 Gong Lo
019 Soft Snare	055 Ride Cup	091 WoodBlock1	127 Gamelan 1	163 Metronome2	199 WhiteNoise
020 LightSnare	056 Ride Cym 1	092 WoodBlock2	128 Gamelan 2	164 OilDrum	200 Jetstar
021 TightSnare	057 Ride Cym 2	093 WoodBlock3	129 Celeste	165 Fist	201 Windbell
022 Ambi.Snare	058 Tom Hi	094 Hand Claps	130 Glocken	166 Close HH	202 Waterphone
023 Rev Snare	059 Tom Lo	095 Syn Claps	131 Vibe 1	167 Stick Hit	203 Lore
024 RollSnare1	060 ProcessTom	096 Zap 1	132 Vibe 2	168 MetalHitHi	204 Tron Up
025 RollSnare2	061 SynTom1 Hi	097 Zap 2	133 Vibe 3	169 MetalHitLo	205 Flute FX
026 Rock Snare	062 SynTom1 Lo	098 Scratch Hi	134 Vibe 4	170 GlassBreak	206 Flutter
027 GatedSnare	063 Syn Tom 2	099 Scratch Lo	135 Pole	171 Drop	207 Cast Roll
028 PowerSnare	064 Brush Tom	100 ScratchDbl	136 TubulBell1	172 CorkPop	208 Harp Up
029 Syn Snare1	065 Agogo	101 Thing	137 TubulBell2	173 Pull 1	209 Jung Gliss
030 Syn Snare2	066 Lo Bongo	102 Mute Cuica	138 TubulBell3	174 Pull 2	210 MalletLoop
031 Gun Shot	067 Hi Bongo	103 Open Cuica	139 Gt Scratch	175 SolidHit	211 MouthHarp1
032 Brush Slap	068 Slap Bongo	104 Vibraslap	140 Chic 1	176 HandDrill	212 MouthHrp1A
033 BrushSwish	069 Claves	105 Guiro S	141 Chic 2	177 Scratch a	213 MouthHarp2
034 BrushSwirl	070 Syn Claves	106 Guiro L	142 Spectrum 1	178 Scratch b	214 MouthHrp2
035 Brush Tap	071 Open Conga	107 Castanet	143 Spectrum 2	179 Scratch c	

PROGRAM

Bank A

#	Name	D.Mod.Src	#	Name	D.Mod.Src	#	Name	D.Mod.Src	#	Name	D.Mod.Src
A00*	Hyper:Wave	JS/VS	A05*	N-Strings	JS/VS	B00*	PipeDreams	JS/VS	B05*	GlockBells	JS/VS
A10*	Ravel Pad	JS/VS	A15*	SlowSunset	JS/VS	B10*	Transforms	JS/VS	B15*	PingMallet	JS/VS
A20*	RunawayPad	JS/VS	A25*	Fragments	JS/VS	B20*	Wave Sweep	JS/VS	B25*	CrystalIce	JS/VS
A30*	Tekno:Sync	JS/VS	A35*	Antartica	JS/VS	B30*	Sputnik	JS/VS	B35*	Logs&Bells	JS/VS
A40*	In The Pad	JS/VS	A45*	Underscore	JS/VS	B40*	LandingPad	JS/VS	B45*	Star Fire	JS/VS
A50*	Wavetables	JS/VS	A55*	VeloVoxPad	JS/VS	B50*	Vortex	JS/VS/AT	B55*	MetalGhost	VS/AT/VDA
A60*	Mod:Matrix	JS/VS	A65*	Padanomic	JS/VS	B60*	TimeClocks	JS/VS	B65*	RealGamlon	JS/VS
A70*	Labyrinth	JS/VS	A75*	AirFantasy	JS/VS	B70*	SynTronic	JS/VS	B75*	TheIceMan	JS/VS/VDA
A80*	Wave World	VS/JS	A85*-	Synth Fife	JS/VS	B80*	Quarks	JS/VS/AT	B85*	Swiss Box	JS/VS
A90*	The7thWave	JS/VS	A95*	TheSandman	JS/VS	B90*	Universe X	JS/VS	B95*	Midi Bells	JS/VS
A01*	N264 Piano	JS/VS	A06*	NuFretless	JS/VS	B01	X Piano	JS/VS	B06*	FatRezBass	JS/VS
A11*	PianoMagic	VS/VDA	A16*	SuperRound	JS/VS	B11*	Killer B	JS/VS	B16*	Upright	JS/VS
A21*	MutronClav	JS/VS/VDA	A26*	Dyno-Bass	---	B21*	FunkyRoads	JS/VS/VDA	B26*	Dance Bass	JS/VS
A31*	TXPianoTap	JS/VS	A36*	Thumb Slap	JS/VS	B31*	Super Perc	JS/VS/AT	B36*	90's Bass	JS/VS
A41*	StereoClav	JS/VS	A46*	Big Bottom	JS/VS	B41	M1 Piano	JS/VS	B46*	SynthBass3	JS/VS
A51*	Dyno Roads	JS/VS	A56*	Clean Bass	JS/VS	B51*	ClickOrgan	JS/VS/AT	B56*	Velo Pick	VS/VDA
A61*	Syn Piano	JS/VS	A66*	Rock Bass	JS/VS	B61*	Classic EP	JS/VS	B66*	ChromeBass	JS/VS
A71*	Wire Clav	JS/VS	A76*	Thumb&Slap	JS/VS	B71	Super BX-3	JS/VS/AT	B76*	Velo Slap	JS/VS
A81*	SynVoxKeys	JS/VS	A86*	Super Bass	JS/VS	B81*	Dyno Tines	JS/VS	B86*	Big Mini	JS/VS
A91*	DW-8000 EP	JS/VS	A96*	Deep House	JS/VS/VDA	B91*	Big Organ	JS/VS/AT	B96*	Stick Bass	JS/VS
A02*	Ultra Rez	JS/VS/AT	A07*	RockSteady	JS/VS/AT	B02*	BigStrings	JS/VS	B07*	BreathyVox	JS/VS
A12*	Arpeggiate	JS/VS	A17*	RealVoices	JS/VS/AT	B12*	Pop Brass	JS/VS/VDA	B17*	Velo Flute	JS/VS
A22*	DoubleMini	JS/VS	A27*	Jazz Organ	JS/VS/AT	B22*	AnaStrings	JS/VS	B27*	Ghost Vox	JS/VS
A32*	Stick-2-It	JS/VS	A37*	Velo"B"	JS/VS/AT	B32*	BrassSwell	JS/VS	B37*	FreshWaves	JS/VS
A42*	SquareBass	VS	A47*-	Small^Orch	JS/VS	B42*	DynoString	JS/VS/VDA	B47*	Woodwinds	JS/VS
A52	Chrome Rez	JS/VS	A57*	Classic"B"	JS/VS/AT	B52*	StereoHorn	JS/VS	B57*	oooooooooze	JS/VS
A62*	LowEndBass	VS/AT	A67*	VocalChoir	JS/VS	B62*	Cello Ens.	VS/VDA	B67*	Real Shaku	JS/VS
A72*	Lo-End-Rez	JS/VS/AT	A77*	Green Eyes	JS/VS/AT	B72*	Trump Ens.	JS/VS	B77	Flutter	JS/VS/VDA
A82*	Cyber Bass	JS/VS	A87	Vox Voice	JS/VS	B82*	VeloFlugel	JS/VS	B87*	Arabesque	JS/VS
A92*	Vibra Harp	JS/VS	A97*	BX3 Medium	JS/VS/AT	B92*	EthnoVioln	JS/VS	B97*	SopranoVox	JS/VS
A03*	MusicaLoop	JS/VS	A08*	TotalSynth	JS/VS	B03*	Asian Jung	JS/VS	B08*	Xanalog	JS/VS
A13*	VoodooSong	JS/VS	A18*	DanceReMix	JS/VS/VDA	B13*	Harp Gliss	VS/VDA	B18	LA Synth	JS/VS
A23*	ClockWorks	JS/VS	A28*	AnalogSync	JS/VS	B23*	Euro Pipe	JS/VS	B28*	FatFilterz	JS/VS/AT
A33	WhiteNoise	JS/VS	A38*	Alaska	VS/AT/VDA	B33*	Lore	VS/VDA	B38*	MIDI Grand	JS/VS
A43*-	DreamBells	JS/VS	A48*	Film Cue	JS/VS	B43	Tamboura	JS/VS	B48*	Reso Waves	JS/VS
A53*	TheSunrise	JS/VS/AT	A58*	Super->Stab	JS/VS/VDA	B53	MalletLoop	JS/VS	B58*	Dr. Tapp	JS/VS
A63	JackSlide	JS/VS	A68*	Ghost Stab	JS/VS	B63*	Godfather	JS/VS	B68*	Split Sync	JS/VS/AT
A73*	Waterphone	JS/VS	A78*	PowerLayer	JS/VS	B73	Jaw Harp	JS/VS	B78*	Swell Pad	JS/VS
A83*	TheHeavens	VS/AT	A88*	SyncNoEvil	JS/VS	B83*	Polka Box	VS/AT	B88*	Syn Brass	VS/VDA
A93*	Toy Bellz	JS/VS	A98*	Mega Synth	JS/VS	B93*	Real Sitar	JS/VS	B98*	Solo Synth	JS/VS/AT
A04*	MonsterWah	JS/VS/AT	A09@	Zulu Kit	JS/VS	B04*	Rock On!!!	JS/VS	B09@	[KrazyKit]	JS/VS
A14*	MiniODLead	JS/VS	A19*	CyberTrash	JS/VS	B14*	BriteSteel	VS/VDA	B19@	[ComboKit]	JS/VS
A24*	Rick&aPick	JS/VS	A29*	Power Play	JS/VS	B24*	Stratified	JS/VS	B29	[Down Low]	JS/VS
A34*	R&R Guitar	JS/VS	A39*-	Lazer Toms	JS/VS	B34*	Follow Me	JS/VS	B39	[Mr. Gong]	JS/VS
A44*	Metal King	JS/VS	A49*	Cyber Hit	JS/VS	B44*	Chruncher	JS/VS/VDA	B49	[Manimals]	JS/VS
A54*	Guitarist	JS/VS	A59@	Modern Kit	JS/VS	B54*	Flamenco	JS/VS	B59	[Loop SFX]	JS/VS
A64*	Mandolin	JS/VS	A69*	ThunderTom	JS/VS	B64	Funk Guitr	JS/VS/VDA	B69	[Nature]	VS/VDA
A74*	Electric12	JS/VS	A79*-	GiantDrums	JS/VS	B74*	Rock Chuga	JS/VS	B79	[Natives!]	JS/VS
A84*-	Light Pizz	JS/VS	A89*-	Mark Trees	JS/VS	B84*	FeedbackGt	VS/VDA	B89*	[DrillMe!]	JS/VS
A94	M1TenorSax	JS/VS	A99*-	OldKalimba	JS/VS	B94*	Greek Gtr.	JS/VS	B99*	[Jet Star]	JS/VS

JS=Joystick, VS=Value Slider, AT=After Touch, VDA=VDA EG, *="Double Mode" Program, @="Drum Mode" Program, --="marked program doesn't sound on higher range of keyboard"

PROGRAM

Bank C

#	Name	D.Mod.Src
C00*	Sunrise	---
C10*	MachineAge	---
C20*	GlideSweep	VS/AT
C30*	Space Wing	---
C40	Neutron	---
C50*	DreamWorld	JS/VS
C60	Spectrum	JS/VS
C70*	InTheTrees	---
C80	Halifax NS	VDA
C90	SteamCloud	VS/AT
C01	Piano 16'	---
C11*	Hot Keys	VS/AT
C21*	Last Tango	---
C31*	Gospel Org	VS/AT
C41*	PianoHaven	JS/VS
C51*	HarpsiFunk	---
C61*	Full Pipes	JS/VS/AT
C71*	SantaClav	---
C81*	Drawbars	VS/AT
C91*	Bouzouki	---
C02*	AltoBreath	---
C12*	Brass Band	VS/VDA
C22*	MagicFlute	---
C32*	Trumpets	---
C42*	Shaku Bend	VS
C52	FlugelHorn	---
C62*	Woodwinds	JS/VS
C72*	Sfz< Brass	JS/VS
C82	Fanfare	JS/VS
C92	BriteBrass	---
C03*	TinyDancer	---
C13*	Maxi Tine	JS/VS
C23*	Operators	JS/VS
C33*	Fresh Air	VDA
C43*	BowenWave	JS/VS
C53*	Elec. Tap	---
C63*	Whirly	JS/VS
C73	Tine Pad	JS/VS
C83*	Hard Tines	VDA
C93	DWGS EP	VS/VDA
C04*	Spruce Gtr	JS/VS
C14*	Power Rock	VS/AT
C24*	E.Guitars	JS/VS
C34*	Rock Mutes	JS/VS
C44*	Clean Funk	JS/VS
C54	Harmonics	JS
C64*	LeadGuitar	JS/VS
C74	PedalSteel	JS
C84*	Dr.Guitar	JS/VS
C94*	JoyStickUp	JS

Bank D

#	Name	D.Mod.Src	#	Name	D.Mod.Src	#	Name	D.Mod.Src
C05*	Vibra Bell	JS/VS	D00*	ElastikPad	VDA	D05*	JewelryBox	---
C15*	Tabla Talk	JS/VS	D10*	Space Pets	JS/VS	D15*	ShamiMalet	JS/VS
C25	Gamelan	JS/VS	D20*	BellShower	JS/VS	D25*	ClockTower	VS/AT
C35*	Dustette	VS/AT	D30	PrarieDawn	---	D35	MagicBell	JS/VS/AT
C45	SplitBell	JS/VS	D40	CicadaBugs	VS/AT	D45*	Borealis	JS
C55*	Africana	VS	D50*	TibetBells	VS/AT	D55*	HardBamboo	JS/VS
C65	Isabelle	VS/VDA	D60	UnderWater	JS	D65*	VS Bells	JS
C75	Log Drums	JS	D70*	Wind Storm	JS/VS	D75*	AfricanJam	---
C85	EtherBells	JS	D80	FlyingToys	JS	D85*	SolarBells	JS
C95	WaveCycles	JS/VS	D90*	Last Dream	---	D95	Ice Bell	VS/VDA
C06*	XFade Bass	JS/VS	D01*	EspressoPF	---	D06*	WoodenYou?	VS/AT
C16*	FingerBass	JS/VS	D11*	VS Organ	VS/AT	D16*	Bass Solo	JS/VS
C26*	Zap Bass	JS/VS	D21*	Fisa 8'	---	D26*	SweepBass	JS/VS
C36	PickedBass	JS/VS	D31	Rotary Org	JS/VS/AT	D36*	Bass/Mute	JS
C46*	Slap It	JS/VS	D41*	Piano&Str	---	D46*	Fat Slap	---
C56*	TechnoBass	VS/AT	D51*	DoubleStop	---	D56	Tech Bass	JS/VS
C66*	Fat Fretty	---	D61*	Organ 1	JS/VS/AT	D66*	Dr.Octave	VS/AT
C76*	HouseBass1	---	D71*	Vectorcord	JS/VS	D76	HouseBass2	---
C86	Bass/Harm	JS/VS	D81*	Tone Wheel	JS/VS/AT	D86*	Funk Bass	VDA
C96*	Rap Bass	JS/VS	D91*	OrganTouch	JS/VS/AT	D96*	Thumb Bass	---
C07*	TheStrings	JS/VS	D02*	PerkySaxes	AT	D07*	Symphonic	---
C17*	LiteVoices	JS/VS	D12*	Brasstereo	---	D17*	Ice Flakes	VS/VDA
C27*	DigitalAir	JS/VS	D22*	TamboFlute	JS/VS	D27*	Pan Mallet	---
C37*	ChamberEns	JS/VS/AT	D32*	Horn Ens	---	D37*	ArcoAttack	JS/VS/VDA
C47*	AnalogPad	JS/VS	D42*	Traverso	---	D47*	Choir L+R	JS/VS
C57*	Airways	---	D52	Warm Tromb	---	D57	Composure	VDA
C67*	Poppin'Pad	---	D62*	SweetReeds	AT	D67*	Pitzpan	VDA
C77*	Ambi.Voice	JS	D72*	War Pipes	---	D77	Bottle Pad	VDA
C87	Air Vox	JS	D82	BasoonOboe	AT	D87	Heavenly	JS/VS
C97*	OoooooPad	---	D92*	Mute Ens.	JS/AT	D97*	Shaku Pad	JS/VS
C08*	PowerSynth	JS/VS	D03*	XFade EP	---	D08*	Lead Stab	JS/VS
C18*	Color Pad	JS/VS	D13*	Methane EP	---	D18*	Chester	---
C28*	Analogist	---	D23*	BuzzComper	VS	D28*	SteamBrass	JS/VS
C38*	Wire Pad	VDA	D33	Super Tine	JS/VS	D38*	High Wire	VS/AT
C48*	Residue	JS/VS	D43*	SpectrumEP	---	D48	CompThing!	VDA
C58*	Busy Boy	JS/VS	D53	WaveTap	---	D58*	BrassSynth	---
C68	Soft Horns	VS	D63*	Mallet EP	---	D68*	Leeeed	---
C78*	MonoLead	VS/AT	D73*	DigiPiano	VDA	D78*	SynBrass 4	AT
C88*	Drum Hit	VS	D83	Emmalisha	JS/VS	D88	Soft Pad	JS/VS
C98	Bright Pad	VDA	D93*	Siesta EP	---	D98*	VeloSweep	---
C09@	Total Kit	JS	D04*	Nylon Gtr	---	D09@	Rave Kit	JS/VS
C19*	Festival!	JS/VS/VDA	D14*	DbIDists	JS	D19*	RhythmJunk	---
C29*	MandoTrem	---	D24*	Strummers	---	D29	CymbalHit	---
C39*	Industrial	---	D34*	ChunkaPick	JS/VS	D39*	Stab Pad	---
C49	Orch Perc	JS/VS	D44	Mr. Clean	JS/VDA	D49	TunedDrums	JS/VS
C59*	Heartbeat	---	D54*	HollowBody	JS	D59*	EchoTabla	VS/AT
C69@	ProducKit	JS/VS	D64*	ElectricAc	JS	D69@	VeloGated	VS
C79*	Hackbrett	---	D74*	12StringGt	JS/VS	D79*	SitarSitar	---
C89	50's SciFi	JS/VS	D84*	Organ 2	VS/AT	D89*	Mysterian	JS/VS
C99*	HarpPluck	JS/VS	D94	FunkGuitar	JS/VS	D99*	InTheUood	VDA

PROGRAM

Bank GM

#	Name	D.Mod.Src	#	Name	D.Mod.Src	#	Name	D.Mod.Src
G01	Piano	VDA	G51	*Analog Pad	AT/VDA	101*	Brightness	VDA
G02	BritePiano	VDA	G52	String Pad	JS/VS	102*	Goblin	VDA
G03*	HammerPno	---	G53	Choir	VDA	103	Echo Drop	---
G04*	HonkeyTonk	VDA	G54	Doo Voice	---	104*	Star Theme	---
G05	New Tines	VDA	G55	Voices	VDA	105*	Sitar	VDA
G06	Digi Piano	JS/VS	G56	Orch Hit	---	106	Banjo	VDA
G07	Harpsicord	VDA	G57	Trumpet	---	107	Shamisen	VDA
G08	Clav	VS/AT/VDA	G58	Trombone	VDA	108	Koto	VDA
G09	Celesta	JS/VDA	G59	Tuba	AT/VDA	109	Kalimba	VDA
G10	Glocken	JS/VS	G60	Muted Trpt	VDA	110*	Scotland	VDA
G11	Music Box	---	G61*	FrenchHorn	VDA	111*	Fiddle	AT/VDA
G12	Vibes	VS	G62	Brass	VDA	112	Shanai	---
G13	Marimba	VDA	G63*	SynBrass 1	VDA	113	Metal Bell	VDA
G14	Xylophon	JS	G64*	SynBrass 2	AT	114	Agogo	---
G15	Tubular	VDA	G65	SopranoSax	VDA	115	SteelDrums	---
G16	Santur	---	G66	Alto Sax	VDA	116	Woodblock	---
G17	Full Organ	VS/AT/VDA	G67	Tenor Sax	VDA	117*	Taiko	---
G18*	Perc Organ	VDA	G68	Bari Sax	VDA	118	Tom	---
G19	BX-3 Organ	VDA	G69	Sweet Oboe	AT	119	Synth Tom	VDA
G20	ChurchPipe	JS	G70	EnglishHrn	VDA	120	Rev Cymbal	JS
G21	Positive	AT	G71	BasoonOboe	AT	121	Fret Noise	VDA
G22	Musette	VDA	G72	Clarinet	VDA	122	NoiseChiff	AT
G23	Harmonica	VDA	G73	Piccolo	VDA	123*	Seashore	JS
G24	Tango	---	G74	Flute	VDA	124*	Birds	---
G25	ClassicGtr	JS	G75	Recorder	AT/VDA	125*	Telephone	---
G26	A.Guitar	VDA	G76	Pan Flute	VDA	126*	Helicopter	---
G27	JazzGuitar	VDA	G77	Bottle	VDA	127*	Stadium!!	JS
G28	Clean Gtr	JS/VS	G78	Shakuhachi	VDA	128	GunShot	---
G29	MuteGuitar	JS/VS	G79	Whistle	VDA	129@	GM Kit	---
G30	Over Drive	JS/VS	G80	Ocarina	VDA	130@	Power Kit	---
G31	DistGuitar	JS	G81*	SquareWave	VDA	131@	Analog Kit	---
G32*	RockMonics	JS/VS	G82*	Saw Wave	VDA	132@	Jazz Kit	---
G33	Jazz Bass	JS/VS	G83*	SynCaliope	AT/VDA	133@	Brush kit	---
G34	Deep Bass	JS/VS	G84*	Syn Chiff	---	134@	Perc Kit	---
G35	Pick Bass	JS/VS	G85*	Charang	VDA	135@	Dance Kit	---
G36	Fretless	JS/VS	G86*	AirChorus	---	136@	Orch Kit	---
G37	SlapBass 1	---	G87*	Rezzo4ths	VDA			
G38	SlapBass 2	AT	G88*	Bass&Lead	---			
G39*	SynthBass1	---	G89*	Fantasia	---			
G40	SynthBass2	VDA	G90	Warm Pad	---			
G41	Violin	AT/VDA	G91*	Poly Pad	---			
G42	Viola	VDA	G92	Ghost Pad	---			
G43	Cello	AT/VDA	G93*	BowedGlass	---			
G44	ContraBass	VDA	G94*	Metal Pad	VDA			
G45	TremoloStr	VDA	G95*	Halo Pad	---			
G46	Pizzicato	JS/VDA	G96	Sweep	VDA			
G47	Harp	VDA	G97*	Ice Rain	---			
G48	Timpani	---	G98*	SoundTrack	---			
G49	Marcato	VDA	G99*	Crystal	---			
G50	SlowString	VDA	100*	Atmosphere	---			

JS=Joystick, VS=Value Slider, AT=After Touch, VDA=VDA EG, *are "Double Mode" Program, @="Drum Mode" Program

COMBINATION

Bank A

#	Name	D.Mod.Src	Type	#	Name	D.Mod.Src	Type
00	FirstLight	JS/VS	Layer	05	Max Impact	JS/VS/VDA	Split/VSw
10	InTheMaze	JS/VS	Layer/VSw	15	Melotronic	JS/VS	Layer
20	XYjoystick	JS/VS	Layer	25	EasternSun	JS/VS	Layer/VSw
30	L.F.O.City	JS/VS	Split	35	9 Inchers	VS/AT	Split
40	Vaporizer	JS/VS	Layer	45	Wet Lands	JS/VS	Split/VSw
50	QuarkSpark	JS/VS	Split	55	WaveJammer	JS/VS/AT	Split
60	Virtuals	VS/AT	Split	65	Botswana	JS/VS	Split/VSw
70	Gyroscope	VS/AT	Layer	75	RagaTrance	JS/VS	Split/VSw
80	Alienesque	JS/VS/AT	Split	85	N:Wave:Seq	JS/VS	Layer
90	Uni Verse	VS/AT	Layer	95	Trinidad	JS/VS	Layer
01	Grinding B	JS/VS/AT	Layer	06	Rave Vox	VS/AT/VDA	Split/VSw
11	Power Keys	VS/VDA	Layer	16	House Mix	VS/VDA	Split
21	Super Jazz	JS/VS/AT	Layer	26	GiantSplit	JS/VS	Split
31	MIDIEP-Pad	VS/VDA	Layer/VSw	36	PhaseTwins	JS/VS	Split
41	BigDrawbar	JS/VS/AT	Layer	46	HouseOfSki	JS/VS/AT	Split/VSw
51	M-1LayerEP	VS/VDA	Layer	56	Green Rave	JS/VS	Split
61	Stax Organ	JS/VS/AT	Layer	66	Asidic	JS/VS	Split
71	Whirly Pad	VS/VDA	Layer	76	X-VoxSplit	JS/VS/AT	Split
81	The Legend	JS/VS/AT	Layer	86	Euroman	JS/VS	Split/VSw
91	O.D. Organ	JS/VS	Layer	96	Enose Horn	JS/VS/AT	Layer
02	Shangri-La	JS/VS	Layer	07	OrchDivisi	JS/VS/VDA	Layer
12	Horn Stabs	JS/VS/VDA	Layer	17	Orch Split	JS/VS	Split/VSw
22	OB-Analog	VS/AT/VDA	Layer	27	Allegro	JS/VS/VDA	Layer/VSw
32	Square Rez	JS/VS/VDA	Split	37	Velo-Pizz	JS/VS/VDA	Layer/VSw
42	Sax Band	JS/VS/VDA	Layer	47	NightMusic	JS/VS/VDA	Layer/VSw
52	PowerStack	JS/VS	Layer	57	Nutcracker	JS/VS/VDA	Layer
62	Anna Split	JS/VS/AT	Split	67	DelayedHit	JS/VS/VDA	Layer/VSw
72	Rezzo Comp	JS/VS/VDA	Layer	77	Serenade	JS/VS/VDA	Layer/VSw
82	Real Horns	JS/VS	Split	87	Orch Winds	JS	Layer
92	Sync Home	JS/VS	Split	97	Ensembled	JS/VS/VDA	Layer/VSw
03	Mast World	JS/VS/AT	Layer	08	SongOfLife	JS/VS	Split/VSw
13	Goldmine	VS/AT	Layer/VSw	18	Morocco	JS/VS/AT	Split/VSw
23	String Cue	JS/VS	Layer/VSw	28	PolyChords	JS/VS	Split/VSw
33	SkyCatLead	JS/VS	Layer	38	TheGamelan	JS/VS	Layer/VSw
43	Boys Choir	JS/VS	Layer	48	NeverLand	JS/VS/AT	Split
53	HitTheDust	JS/VS	Layer/VSw	58	NightTrain	JS/VS	Split
63	ArcoString	JS/VS	Layer	68	Sir Robin	JS/VS	Split
73	Voices2Men	JS/VS/AT	Layer/VSw	78	Jazz Duet	JS/VS	Split
83	Eternal	JS/VS	Layer	88	Pacifica	VS/AT	Split
93	AngelChoir	JS/VS	Layer	98	There&Back	JS/VS	Split
04	World Bass	JS/VS	Layer	09	Dance Trak	JS/VS	Split
14	Maya Dance	JS/VS/AT	Layer	19	Didjeridoo	VS/AT	Layer/VSw
24	RhythmnGtr	JS/VS	Layer/VSw	29	PowerHouse	JS/VS	Split
34	Fade Away	JS/VS	Layer	39	UnderWorld	JS/VS	Layer
44	HeartBreak	JS/VS	Split	49	DJ*ToolBox	JS/VS	Layer/VSw
54	Power Band	VS/AT	Split	59	Worm Hole	VS/AT	Layer
64	Slap Stick	JS/VS	Layer/VSw	69	EtherScape	JS/VS	Split
74	Fret-Not!	JS/VS	Layer	79	AlienProbe	JS/VS	Split/VSw
84	InTheArena	JS/VS	Layer	89	TheBigBang	JS/VS	Split
94	Prog Split	VS/AT	Split	99	Sea Storm	VS/VDA	Layer

COMBINATION

Bank B

#	Name	D.Mod.Src	Type	#	Name	D.Mod.Src	Type
00	SolarFlare	JS/VS	Layer/VSw	05	HeadHunter	JS/VS	Layer/VSw
10	<The West>	JS/VS	Layer/VSw	15	<The East>	JS/VS	Layer/VSw
20	Warriors	JS/VS	Layer	25	EthnicOrch	JS/VS	Layer/VSw
30	AncientSun	JS/VS	Layer	35	EastAfrica	JS/VS	Layer/VSw
40	<<Heaven>>	JS/VS	Layer/VSw	45	Zen Garden	JS/VS	Layer/VSw
50	Megatron	JS/VS	Layer/VSw	55	Indian Jam	JS/VS	Layer/VSw
60	Crossfades	JS/VS	Layer	65	RhythmPipe	JS/VS	Layer/VSw
70	New Worlds	VS/AT	Layer	75	Warm Koto	JS/VS	Layer
80	Galaxia	JS/VS	Layer/VSw	85	Lost Tribe	JS/VS	Layer/VSw
90	The Abyss	JS/VS	Layer	95	RainForest	JS/VS	Layer/VSw
01	StereoKeys	JS/VS	Layer/VSw	06	Rock Organ	JS/VS	Layer
11	Super EP	JS/VS	Layer	16	ChorusClav	JS/VS	Layer/VSw
21	Fat Pianos	JS/VS	Layer	26	Cathedral	JS/VS	Layer
31	Velo Roads	JS/VS	Layer/VSw	36	Ultra Perc	JS/VS/AT	Layer
41	Rock Piano	JS/VS	Layer	46	Accordion	VS/VDA	Layer
51	Bs/EP&Str	JS/VS	Split	56	Harpicord	JS/VS	Layer
61	SuperKeys	VS	Layer	66	FullManual	JS/VS/AT	Layer
71	Digi Piano	JS/VS	Layer	76	Rock Show!	JS/VS	Layer
81	Bass/Piano	VS	Split	86	DualManual	JS/VS/AT	Split
91	Piano&Str	JS/VS	Layer	96	PipeOrgan	JS/VS	Layer
02	X Strings	VS/VDA	Layer	07	X Brass	JS/VS	Layer
12	Wind->Orch	JS/VS	Layer/VSw	17	Bass/Horn	JS/VS/VDA	Split/VSw
22	Sonata	VS/VDA	Layer	27	BrassSwell	JS/VS	Layer
32	Symphony	JS/VS/VDA	Layer	37	TheSaxMen	JS/VS	Layer
42	ChamberOrc	JS/VS/VDA	Layer	47	MutedHorns	VS/VDA	Layer
52	Fanfare	VS/VDA	Layer	57	Bass/Brass	JS/VS	Layer/VSw
62	WoodWinds	JS/VS/VDA	Layer/VSw	67	Bows/Trpt	VS/VDA	Split
72	FullString	VS/VDA	Layer	77	Big Band	JS/VS/VDA	Layer
82	Str/Oboe	JS/VS/VDA	Split	87	Trpt&Bones	JS/VS	Layer
92	ChamberStr	JS/VS	Layer	97	Hot Salsa	VS/VDA	Layer/VSw
03	AnalogKing	JS/VS	Layer	08	TheSingers	VS/VDA	Layer
13	Maxi Stab	JS/VS	Layer	18	Ice Bells	JS/VS	Layer
23	LayerSynth	JS/VS	Layer	28	Java Bells	JS/VS	Layer
33	NeuroFunk	VS	Layer/VSw	38	LunarBells	JS/VS	Layer
43	Multi Rez	JS/VS/VDA	Layer	48	PizzoSynth	JS/VS	Layer
53	Big Swell	JS/VS	Layer	58	Moon Stone	JS/VS	Layer
63	OctaveLead	JS/VS/AT	Layer	68	Airiana	JS/VS	Layer
73	Rezzo Funk	JS/VS	Layer	78	Vox Bells	JS/VS	Layer
83	RezzoSplit	JS/VS	Split	88	Bellendra	JS/VS	Layer/VSw
93	Hard Sync	JS/VS	Layer/VSw	98	Prisms	JS/VS	Layer
04	CrankItUp!	JS/VS	Layer/VSw	09	Wild Drums	JS/VS	Layer
14	12 String	JS/VS	Layer	19	Wild Split	JS/VS	Layer
24	WaveGuitar	JS/VS	Layer	29	PhantomSax	JS/VS	Layer/VSw
34	Slappin'	JS/VS	Layer/VSw	39	<<<Hell>>>	JS/VS	Layer
44	Chorus Gtr	JS/VS	Layer	49	RapToolKit	JS/VS	Layer/VSw
54	StickSplit	JS/VS/VDA	Split	59	Torquemada	JS/VS	Layer
64	Malaguena	VS/VDA	Split	69	SpaceZones	JS/VS	Split
74	Guitar Man	VS/VDA	Layer/VSw	79	MenAtWork	JS/VS/VDA	Layer
84	TheOldWest	JS/VS	Split	89	Star Lense	JS/VS	Layer
94	Gtr/Flute	JS/VS	Split	99	TheDentist	JS/VS	Layer

JS=Joystick, VS=Value Slider, AT=After Touch, VDA=VDA EG, VSw=Velocity Switch

COMBINATION

Bank C

#	Name	D.Mod.Src	Type	#	Name	D.Mod.Src	Type
00	Star*Burst	VS/AT	Split/VSw	05	Calcutta	---	Split/VSw
10	First*Snow	VDA	Split	15	Javanese	JS/VS	Layer
20	Rezolution	JS/VS/VDA	Layer	25	Tethnical	---	Split/VSw
30	StormOf'93	VDA	Layer	35	Bass&Vibes	JS/VS	Split/VSw
40	Bell Come!	JS/VS	Layer	45	Instanbul	AT	Split/VSw
50	Beach Walk	VDA	Layer	55	SugarBells	VS/AT	Split/VSw
60	Autumn	VDA	Layer	65	Ethno Geo	---	Split
70	Child Song	---	Split	75	Bolshoi	JS/VS	Layer
80	SunOfTron	JS/VS/AT	Split/VSw	85	The Sphinx	JS/VS	Split/VSw
90	FreeTime	VS/AT	Split	95	ChinaBell	JS/VS	Split/VSw
01	LayerPiano	VDA	Layer	06	FunkySpice	VS/AT	Layer
11	Bass&Piano	VS	Split/VSw	16	L'ilBit O'	AT	Layer
21	The Gospel	JS/VS	Layer/VSw	26	Full Pipe	---	Layer
31	Stak'oMidi	VDA	Layer	36	Super Perc	VS	Layer
41	EP&String	---	Layer	46	Busy Split	---	Split/VSw
51	DynoPiano	VS	Split	56	Blues Harp	JS/VS	Layer
61	ElecPno&Bs	VS	Split/VSw	66	Ruff&Ready	JS/VS	Layer
71	Pontette	AT/VDA	Layer	76	Wasp Sting	VS/AT	Layer
81	SamAntic	JS/VS	Split/VSw	86	Deep Organ	---	Layer
91	PianoSings	VDA	Split	96	Sky Cat	JS/VS	Layer
02	Synth Fat	VS/VS	Layer	07	Layer Str	JS/VS	Layer
12	Full Brass	VDA	Split/VSw	17	Philarmoney	JS/VS	Split/VSw
22	New Rave	JS/VS/AT	Split/VSw	27	Overture	JS/VS	Split/VSw
32	SmokyHorn	JS/VS	Split	37	Pizz & Bow	JS/VS	Layer
42	Latin Band	JS/VS	Split/VSw	47	Orchestral	JS/VS	Split
52	Centrefold	---	Layer	57	Grandioso	JS/VS/VDA	Split
62	MasterFunk	---	Split/VSw	67	Madrigal	JS/VS	Layer
72	GoToSweep	JS/VS	Layer	77	AnaStrings	VDA	Layer
82	SweetMutes	VS	Layer	87	StringsAtk	JS/VS	Layer
92	BiggerIdea	---	Split	97	HarpString	JS/VS	Layer
03	Satellite	---	Layer	08	Sax Heaven	VS/VDA	Split
13	Sing To Me	VDA	Split	18	Half Moons	VS/AT	Layer
23	FlutterPad	---	Layer	28	Lead & Pad	JS/VS	Split
33	VeloVoxBel	VS	Layer/VSw	38	Aquarium	VDA	Split
43	HumanBeam	JS/VS	Split/VSw	48	CymbalLife	---	Layer
53	InTheLight	JS/VS	Split	58	Osaka Jazz	JS/VS/VDA	Split
63	VeloVoices	JS/VS	Layer/VSw	68	ChiffSplit	---	Split
73	SilkRoad33	VS/AT	Split	78	ChrisTall	JS/VS	Split/VSw
83	Nebulae	JS/VS	Layer	88	Lassie&Tim	---	Split
93	Safari	---	Split	98	Night Taps	JS/VS	Layer
04	Mr. Tone	---	Split	09	Celebrate!	JS/VS/VDA	Split/VSw
14	Mr.Chorus	JS/VS	Split/VSw	19	HereItComz	JS/VS	Split/VSw
24	ShoeString	---	Split	29	Dulcimer	VS/AT	Layer
34	Slap & Pop	---	Layer/VSw	39	HouseParty	JS/VS	Split/VSw
44	12 Stereo	---	Split/VSw	49	Space Port	VS/AT	Split
54	Velo Chord	JS/VS	Split/VSw	59	MasterFisa	JS/VS	Layer
64	Split Bass	VS	Split/VSw	69	Dagobar	JS/VS	Layer
74	Nashville	---	Split	79	Rave Hits	JS/VDA	Layer
84	Dole Bee	VDA	Split/VSw	89	DeathStars	JS/VS	Split/VSw
94	Guitar&Pad	JS/VS	Split	99	Slammin'	JS/VS	Split/VSw

COMBINATION

Bank D

#	Name	D.Mod.Src	Type	#	Name	D.Mod.Src	Type
00	Sea Horses	VS/AT	Split/VSw	05	IndianOrch	JS/VS	Split/VSw
10	Backyard	JS	Layer	15	Fairy Bell	AT	Layer
20	Right&Left	VS/VDA	Layer	25	Ethnetic	VS	Split
30	Rain Chime	JS/VS	Split	35	VibeRation	JS/VS	Layer
40	Blade Runs	JS/VS	Split/VSw	45	Sting&Wind	VDA	Split
50	PowderSnow	VS/AT	Layer	55	Baseball	---	Layer
60	Pollenesk	VDA	Layer	65	Milagro	VDA	Layer/VSw
70	TheyAppear	JS/VS	Split	75	12ToneBelz	JS/VS/AT	Split
80	Vectoring	JS/VS	Layer	85	ShakAttack	JS/VS	Split/VSw
90	Encounters	VS/AT	Layer	95	Randomizer	VS	Layer/VSw
01	Power Comp	VDA	Layer	06	Pop Clav	VS	Layer
11	CountOnMe	---	Split	16	Rotary Man	VS/AT	Layer
21	Two In One	JS/VS	Split/VSw	26	WeddingDay	---	Split
31	Remedies	---	Split/VSw	36	SplitOrgan	---	Split
41	Piano Pad	VDA	Layer	46	ToBeBass	JS/VS	Split
51	Tiny&Tiny	VS	Split/VSw	56	Organ Pad	---	Split
61	Bass&EP	VS	Split/VSw	66	Fusionist	JS/VS	Layer
71	Emmabama	VS	Layer/VSw	76	Have Fun	JS/VS	Split
81	Hard&Sweet	VS/AT	Split	86	Mixture	---	Split
91	Layer Cake	---	Layer	96	Fuzz EP	---	Layer
02	Midi Winds	---	Layer	07	Double Bow	VDA	Layer
12	Trpt.Brass	---	Layer	17	Leti Theme	JS/VS	Split/VSw
22	ODriveLead	JS/VS/AT	Layer	27	Concerto	VS	Split
32	Big Band	VDA	Split/VSw	37	Pizz A Pie	JS/VS	Layer
42	MillerTime	AT	Split/VSw	47	Delicato	JS/VS	Layer
52	Emmalog	---	Layer	57	BigStrings	VS	Split
62	BadScream	VS	Layer/VSw	67	WoodSector	VDA	Split/VSw
72	TheSweeper	JS/VS	Split	77	Bows&Brass	JS/VS	Split
82	Trombhorn	---	Split	87	The Finale	---	Split/VSw
92	Puffalog	VDA	Layer	97	HornMelody	JS/VS	Split
03	ProxiMidi	---	Layer	08	Alto Dream	VS	Split
13	Acappella	JS/VS	Layer	18	Canyon	JS/VS/AT	Layer
23	TheRedSun	JS/VS	Layer	28	LegatoReed	JS/VS	Split
33	VoxGamelan	---	Layer	38	TechnoPres	VS/AT	Layer
43	Wood Vox	---	Layer	48	Sophism	---	Layer
53	Dreamy P	AT/VDA	Layer	58	Cool Duet	---	Split
63	AlienSings	JS/VS	Layer	68	TypeALine	JS/VS	Split
73	Dreaming	AT/VDA	Layer	78	Echo Suite	---	Split
83	Synmonics	JS/VS/VDA	Layer/VSw	88	Fif-Dsplit	---	Split
93	Pad+Alpha	VDA	Layer	98	Acid Tools	JS/VS/VDA	Layer
04	Oh-La-La !	JS/VS	Split	09	VillageJam	JS/VS	Split/VSw
14	AndyPlayIt	JS/VS	Layer/VSw	19	StealDrums	VS	Split
24	Guitairs	JS/VS	Split/VSw	29	Bavaria	AT	Split
34	DynamoBass	VS	Layer/VSw	39	Witch Hunt	JS/VS	Split/VSw
44	Folk Picks	---	Split/VSw	49	Ethno Vox	JS/VS	Split
54	RockShow!	JS/VS	Split	59	Mazurca	JS/VS	Split
64	Bass Solo	JS/VS	Layer/VSw	69	Bug Forest	JS/VS	Split/VSw
74	Fat Pluck	---	Layer	79	Percolator	JS/VS	Split
84	TwoWorlds!	VS	Layer/VSw	89	AfricaMood	VS	Split
94	BreakADish	---	Split/VSw	99	TimeTunnel	VS/AT	Layer

JS=Joystick, VS=Value Slider, AT=After Touch, VDA=VDA EG, VSw=Velocity Switch

DRUMKIT

Drum Kit A1

#	Inst	Key	Excl
#00	001:Rock Kick	C2	---
#01	036:Side Stick	C#2	---
#02	031:Gun Shot	D2	---
#03	094:Hand Claps	D#2	---
#04	022:Ambi.Snare	E2	---
#05	060:ProcessTom	F2	---
#06	048:Tite HH	F#2	EX1
#07	060:ProcessTom	G2	---
#08	050:Pedal HH	G#2	EX1
#09	060:ProcessTom	A2	---
#10	049:Open HH	A#2	EX1
#11	060:ProcessTom	B2	---
#12	060:ProcessTom	C3	---
#13	040:Crash Cym	C#3	---
#14	060:ProcessTom	D3	---
#15	054:Ride Edge	D#3	---
#16	040:Crash Cym	E3	---
#17	055:Ride Cup	F3	---
#18	085:Tambourine	F#3	---
#19	044:Splash Cym	G3	---
#20	086:Cowbell	G#3	---
#21	040:Crash Cym	A3	---
#22	104:Vibraslap	A#3	---
#23	056:Ride Cym 1	B3	---
#24	067:Hi Bongo	C4	---
#25	066:Lo Bongo	C#4	---
#26	074:Mute Conga	D4	---
#27	071:Open Conga	D#4	---
#28	071:Open Conga	E4	---
#29	089:Hi Timbal	F4	---
#30	090:Lo Timbal	F#4	---
#31	065:Agogo	G4	---
#32	065:Agogo	G#4	---
#33	081:Cabasa	A4	---
#34	080:Maracas	A#4	---
#35	150:Whistle S	B4	EX2
#36	151:Whistle L	C5	EX2
#37	105:Guiro S	C#5	EX3
#38	106:Guiro L	D5	EX3
#39	069:Claves	D#5	---
#40	092:WoodBlock2	E5	---
#41	059:Tom Lo	F5	---
#42	048:Tite HH	F#5	EX4
#43	059:Tom Lo	G5	---
#44	049:Open HH	G#5	EX4
#45	058:Tom Hi	A5	---
#46	047:OrchCym LP	A#5	EX4
#47	011:Syn Kick 2	B1	---
#48	149:JingleBell	B5	---
#49	147:Bell Tree	C6	---
#50	084:OpenTriang	C#6	EX5
#51	084:OpenTriang	D6	EX5
#52	083:MuteTriang	D#6	EX5
#53	021:TightSnare	A1	---
#54	030:Syn Snare2	G1	---
#55	026:Rock Snare	F1	---
#56	002:Ambi.Kick	E1	---
#57	000:Fat Kick	F#1	---
#58	010:Syn Kick1	G#1	---
#59	023:Rev Snare	A#1	---

Drum Kit A2

#	Inst	Key	Excl
#00	003:Crisp Kick	C2	---
#01	010:Syn Kick 1	C#2	---
#02	002:Ambi.Kick	D2	---
#03	007:Gated Kick	D#2	---
#04	006:Dance Kick	E2	---
#05	005:Real Kick	F2	---
#06	012:Syn Kick 3	F#2	---
#07	030:Syn Snare2	G2	---
#08	028:PowerSnare	G#2	---
#09	029:Syn Snare1	A2	---
#10	019:Soft Snare	A#2	---
#11	021:TightSnare	B2	---
#12	020:LightSnare	C3	---
#13	022:Ambi.Snare	C#3	---
#14	015:Snare 2	D3	---
#15	031:Gun Shot	D#3	---
#16	095:Syn Claps	E3	---
#17	086:Cowbell	F3	---
#18	048:Tite HH	F#3	EX1
#19	051:CloseSynHH	G3	EX2
#20	050:Pedal HH	G#3	EX1
#21	052:Open SynHHA3	EX2	
#22	049:Open HH	A#3	EX1
#23	084:OpenTriang	B3	---
#24	040:Crash Cym	C4	---
#25	044:Splash Cym	C#4	---
#26	084:OpenTriang	D4	---
#27	085:Tambourine	D#4	---
#28	083:MuteTriang	E4	---
#29	071:Open Conga	F4	---
#30	071:Open Conga	F#4	---
#31	072:Slap Conga	G4	---
#32	072:Slap Conga	G#4	---
#33	074:Mute Conga	A4	---
#34	074:Mute Conga	A#4	---
#35	073:Palm Conga	B4	---
#36	066:Lo Bongo	C5	---
#37	119:Log Drum 1	C#5	---
#38	120:Log Drum 2	D5	---
#39	121:Log Drum 3	D#5	---
#40	122:Log Drum 4	E5	---
#41	145:BrushNoise	F5	---
#42	108:FingerSnap	F#5	---
#43	181:BISS	G5	---
#44	182:BOOFN	G#5	---
#45	183:BOOGETA	A5	---
#46	184:CHLACK	A#5	---
#47	192:Monkey 1	B5	---
#48	102:Mute Cuica	C6	---
#49	103:Open Cuica	C#6	---
#50	212:MouthHrp1A	D6	---
#51	213:MouthHarp2	D#6	---
#52	214:MouthHrp2A	E6	---
#53	210:MalletLoop	F6	---
#54	202:Waterphone	F#6	---
#55	210:MalletLoop	G6	---
#56	201:Windbell	G#6	---
#57	213:MouthHarp2	A6	---
#58	139:Gt Scratch	B6	---
#59	209:Jung Gliss	C7	---

Drum Kit B1

#	Inst	Key	Excl
#00	046:Orch Crash	B1	---
#01	000:Fat Kick	C2	---
#02	001:Rock Kick	C#2	---
#03	002:Ambi.Kick	D2	---
#04	012:Syn Kick 3	D#2	---
#05	007:Gated Kick	E2	---
#06	018:PicloSnare	F2	---
#07	019:Soft Snare	F#2	---
#08	027:GatedSnare	G2	---
#09	029:Syn Snare1	G#2	---
#10	014:Snare 1	A2	---
#11	036:Side Stick	A#2	---
#12	026:Rock Snare	B2	---
#13	059:Tom Lo	C3	---
#14	060:ProcessTom	C#3	---
#15	059:Tom Lo	D3	---
#16	060:ProcessTom	D#3	---
#17	059:Tom Lo	E3	---
#18	048:Tite HH	F3	EX1
#19	060:ProcessTom	F#3	---
#20	166:Close HH	G3	EX1
#21	060:ProcessTom	G#3	---
#22	049:Open HH	A3	EX1
#23	085:Tambourine	A#3	---
#24	050:Pedal HH	B3	EX1
#25	040:Crash Cym	C4	---
#26	040:Crash Cym	C#4	---
#27	054:Ride Edge	D4	---
#28	055:Ride Cup	D#4	---
#29	082:SynMaracas	E4	---
#30	081:Cabasa	F4	---
#31	094:Hand Claps	F#4	---
#32	066:Lo Bongo	G4	---
#33	068:Slap Bongo	G#4	---
#34	067:Hi Bongo	A4	---
#35	086:Cowbell	A#4	---
#36	071:Open Conga	B4	---
#37	071:Open Conga	C5	---
#38	090:Lo Timbal	C#5	---
#39	083:MuteTriang	D5	EX2
#40	089:Hi Timbal	D#5	---
#41	084:OpenTriang	E5	EX2
#42	086:Ride Cym 1	F5	---
#43	057:Ride Cym 2	F#5	---
#44	042:China Cym	G5	---
#45	023:Rev Snare	G#5	EX3
#46	022:Ambi.Snare	A5	EX3
#47	024:RollSnare1	A#5	EX4
#48	025:RollSnare2	B5	EX4
#49	044:Splash Cym	C6	---
#50	167:Stick Hit	C#6	---
#51	095:Syn Claps	D6	---
#52	070:Syn Claves	D#6	---
#53	062:SynTom1 Lo	E6	---
#54	062:SynTom1 Lo	F6	---
#55	037:Syn Rim	F#6	---
#56	053:Sagat	G6	---
#57	101:Thing	G#6	---
#58	147:Bell Tree	A#6	---
#59	201:Windbell	C7	---

Drum Kit B2

#	Inst	Key	Excl
#00	000:Fat Kick	C2	---
#01	182:BOOFN	C#2	EX1
#02	015:Snare 2	D2	---
#03	188:POOM	D#2	EX1
#04	186:COUGH	E2	EX1
#05	181:BISS	F2	EX1
#06	173:Pull 1	F#2	---
#07	187:ISSH	G2	EX1
#08	171:Drop	G#2	---
#09	185:COOSH	A2	EX1
#10	174:Pull 2	A#2	---
#11	184:CHLACK	B2	EX1
#12	183:BOOGETA	C3	EX1
#13	170:GlassBreak	C#3	---
#14	191:Growl!	B1	---
#15	170:GlassBreak	D#3	---
#16	191:Growl!	E3	SLF
#17	191:Growl!	F3	SLF
#18	180:Sword	F#3	---
#19	180:Sword	G3	---
#20	165:Fist	G#3	EX2
#21	165:Fist	A3	EX3
#22	204:Tron Up	A#3	EX2
#23	204:Tron Up	B3	EX3
#24	172:CorkPop	C4	---
#25	172:CorkPop	C#4	---
#26	176:HandDrill	D4	SLF
#27	176:HandDrill	D#4	SLF
#28	189:Uhhh!	E4	SLF
#29	189:Uhhh!	F4	SLF
#30	190:Samurai!	F#4	SLF
#31	190:Samurai!	G4	SLF
#32	200:Jetstar	G#4	SLF
#33	200:Jetstar	A4	SLF
#34	211:MouthHarp1	A#4	EX4
#35	213:MouthHarp2	B4	EX4
#36	212:MouthHrp1A	C5	EX4
#37	199:WhiteNoise	C#5	---
#38	031:Gun Shot	D5	---
#39	096:Zap 1	D#5	---
#40	097:Zap 2	E5	---
#41	192:Monkey 1	F5	SLF
#42	193:Monkey 2	F#5	SLF
#43	169:MetalHitLo	G5	---
#44	168:MetalHitHi	G#5	---
#45	146:Gt Slide	A5	SLF
#46	198:Gong Lo	A#5	---
#47	207:Cast Roll	B5	EX5
#48	107:Castanet	C6	EX5
#49	164:OilDrum	C#6	---
#50	175:SolidHit	D6	---
#51	101:Thing	D#6	---
#52	196:FingCymbal	E6	---
#53	179:Scratch c	F6	EX6
#54	177:Scratch a	F#6	EX6
#55	178:Scratch b	G6	EX6
#56	098:Scratch Hi	G#6	EX6
#57	099:Scratch Lo	A6	EX6
#58	100:ScratchDbl	A#6	EX6
#59	161:Orch Hit	C7	---

DRUMKIT

Drum Kit C1

#	Inst	Key	Excl
#00	046:Orch Crash	B1	---
#01	000:Fat Kick	C2	---
#02	005:Real Kick	C#2	---
#03	002:Ambi.Kick	D2	---
#04	012:Syn Kick 3	D#2	---
#05	007:Gated Kick	E2	---
#06	018:PicloSnare	F2	---
#07	019:Soft Snare	F#2	---
#08	027:GatedSnare	G2	---
#09	029:Syn Snare1	G#2	---
#10	014:Snare 1	A2	---
#11	036:Side Stick	A#2	---
#12	026:Rock Snare	B2	---
#13	059:Tom Lo	C3	---
#14	060:ProcessTom	C#3	---
#15	059:Tom Lo	D3	---
#16	060:ProcessTom	D#3	---
#17	058:Tom Hi	E3	---
#18	048:Tite HH	F3	EX1
#19	051:CloseSynHH	F#3	EX3
#20	048:Tite HH	G3	EX1
#21	052:Open SynHH	G#3	EX3
#22	049:Open HH	A3	EX1
#23	085:Tambourine	A#3	---
#24	050:Pedal HH	B3	EX1
#25	040:Crash Cym	C4	---
#26	040:Crash Cym	C#4	---
#27	054:Ride Edge	D4	---
#28	055:Ride Cup	D#4	---
#29	082:SynMaracas	F4	---
#30	081:Cabasa	F#4	---
#31	094:Hand Claps	F#4	---
#32	066:Lo Bongo	G4	---
#33	068:Slap Bongo	G#4	---
#34	067:Hi Bongo	A4	---
#35	086:Cowbell	A#4	---
#36	071:Open Conga	B4	---
#37	071:Open Conga	C5	---
#38	090:Lo Timbal	C#5	---
#39	083:MuteTriang	D5	EX4
#40	089:Hi Timbal	D#5	---
#41	084:OpenTriang	E5	EX4
#42	098:Scratch Hi	F5	EX2
#43	099:Scratch Lo	F#5	EX2
#44	100:ScratchDb1	G5	EX2
#45	023:Rev Snare	G#5	EX5
#46	022:Ambi.Snare	A5	EX5
#47	024:RollSnare1	A#5	EX6
#48	025:RollSnare2	B5	EX6
#49	135:Pole	C6	---
#50	030:Syn Snare2	C#6	---
#51	095:Syn Claps	D6	---
#52	070:Syn Claves	D#6	---
#53	062:SynTom1 Lo	E6	---
#54	062:SynTom1 Lo	F6	---
#55	037:Syn Rim	F#6	---
#56	063:Syn Tom 2	G6	---
#57	063:Syn Tom 2	A6	---
#58	063:Syn Tom 2	B6	---
#59	147:Bell Tree	C7	---

Drum Kit C2

#	Inst	Key	Excl
#00	004:Punch Kick	C2	---
#01	003:Crisp Kick	C#2	---
#02	000:Fat Kick	D2	---
#03	005:Real Kick	D#2	---
#04	001:Rock Kick	E2	---
#05	002:Ambi.Kick	F2	---
#06	007:Gated Kick	F#2	---
#07	009:Metal Kick	G2	---
#08	008:ProcesKick	G#2	---
#09	006:Dance Kick	A2	---
#10	012:Syn Kick 3	A#2	---
#11	010:Syn Kick 1	B2	---
#12	011:Syn Kick 2	C3	---
#13	013:Orch B.Drm	C#3	---
#14	014:Snare 1	D3	---
#15	019:Soft Snare	D#3	---
#16	015:Snare 2	E3	---
#17	018:PicloSnare	F3	---
#18	017:Snare 4	F#3	---
#19	016:Snare 3	G3	---
#20	020:LightSnare	G#3	---
#21	027:GatedSnare	A3	---
#22	021:TightSnare	A#3	---
#23	028:PowerSnare	B3	---
#24	022:Ambi.Snare	C4	---
#25	023:Rev Snare	C#4	---
#26	026:Rock Snare	D4	---
#27	024:RollSnare1	D#4	EX4
#28	025:RollSnare2	E4	EX4
#29	036:Side Stick	F4	---
#30	029:Syn Snare1	F#4	---
#31	030:Syn Snare2	G4	---
#32	031:Gun Shot	G#4	---
#33	038:VocalSnr 1	A4	---
#34	033:BrushSwish	A#4	---
#35	034:BrushSwirl	B4	EX1
#36	035:Brush Tap	C5	EX1
#37	032:Brush Slap	C#5	EX1
#38	048:Tite HH	D5	EX2
#39	049:Open HH	D#5	EX2
#40	050:Pedal HH	E5	EX2
#41	051:CloseSynHH	F5	EX3
#42	052:Open SynHH	F#5	EX3
#43	040:Crash Cym	G5	---
#44	044:Splash Cym	G#5	---
#45	042:China Cym	A5	---
#46	054:Ride Edge	A#5	---
#47	055:Ride Cup	B5	---
#48	056:Ride Cym 1	C6	---
#49	057:Ride Cym 2	C#6	---
#50	059:Tom Lo	D6	---
#51	059:Tom Lo	D#6	---
#52	058:Tom Hi	E6	---
#53	060:ProcessTom	F6	---
#54	060:ProcessTom	F#6	---
#55	062:SynTom1 Lo	G6	---
#56	061:SynTom1 Hi	G#6	---
#57	063:Syn Tom 2	A6	---
#58	064:Brush Tom	B6	---
#59	064:Brush Tom	C7	---

Drum Kit D1

#	Inst	Key	Excl
#00	005:Real Kick	C2	---
#01	036:Side Stick	C#2	---
#02	014:Snare 1	D2	---
#03	094:Hand Claps	D#2	---
#04	019:Soft Snare	E2	---
#05	059:Tom Lo	F2	---
#06	048:Tite HH	F#2	EX4
#07	048:Tite HH	G2	EX4
#08	049:Open HH	G#2	EX4
#09	059:Tom Lo	A2	---
#10	049:Open HH	A#2	EX4
#11	050:Pedal HH	B2	EX4
#12	059:Tom Lo	C3	---
#13	040:Crash Cym	C#3	---
#14	040:Crash Cym	D3	---
#15	054:Ride Edge	D#3	---
#16	055:Ride Cup	E3	---
#17	071:Open Conga	F3	---
#18	072:Slap Conga	F#3	---
#19	071:Open Conga	G3	---
#20	091:WoodBlock1	G#3	---
#21	086:Cowbell	A3	---
#22	069:Claves	A#3	---
#23	090:Lo Timbal	B3	---
#24	089:Hi Timbal	C4	---
#25	088:R-Timbal	C#4	---
#26	066:Lo Bongo	D4	---
#27	085:Tambourine	D#4	---
#28	067:Hi Bongo	E4	EX3
#29	068:Slap Bongo	F4	EX3
#30	081:Cabasa	F#4	---
#31	082:SynMaracas	G4	EX5
#32	081:Cabasa	G#4	---
#33	081:Cabasa	A4	EX5
#34	080:Maracas	A#4	EX1
#35	080:Maracas	B4	EX1
#36	083:MuteTriang	C5	EX6
#37	108:FingerSnap	C#5	---
#38	084:OpenTriang	D5	EX6
#39	107:Castanet	D#5	---
#40	093:WoodBlock3	E5	---
#41	092:WoodBlock2	F5	---
#42	065:Agogo	F#5	---
#43	091:WoodBlock1	G5	---
#44	065:Agogo	G#5	---
#45	069:Claves	A5	---
#46	065:Agogo	A#5	---
#47	070:Syn Claves	B5	---
#48	071:Open Conga	C6	---
#49	086:Cowbell	C#6	---
#50	071:Open Conga	D6	EX1
#51	093:WoodBlock3	D#6	---
#52	074:Mute Conga	E6	EX1
#53	071:Open Conga	F6	EX2
#54	150:Whistle S	F#6	EX2
#55	072:Slap Conga	G6	EX2
#56	151:Whistle L	G#6	EX2
#57	073:Palm Conga	A6	EX2
#58	101:Thing	B6	---
#59	147:Bell Tree	G7	---

Drum Kit D2

#	Inst	Key	Excl
#00	010:Syn Kick 1	C2	---
#01	002:Ambi.Kick	C#2	---
#02	012:Syn Kick 3	D2	---
#03	007:Gated Kick	D#2	---
#04	006:Dance Kick	E2	---
#05	005:Real Kick	F2	---
#06	011:Syn Kick 2	F#2	---
#07	030:Syn Snare2	G2	---
#08	028:PowerSnare	G#2	---
#09	029:Syn Snare1	A2	---
#10	019:Soft Snare	A#2	---
#11	021:TightSnare	B2	---
#12	020:LightSnare	C3	---
#13	022:Ambi.Snare	C#3	---
#14	015:Snare 2	D3	---
#15	031:Gun Shot	D#3	---
#16	095:Syn Claps	E3	---
#17	086:Cowbell	F3	---
#18	048:Tite HH	F#3	EX1
#19	051:CloseSynHH	G3	EX2
#20	050:Pedal HH	G#3	EX1
#21	052:Open SynHH	A3	EX2
#22	049:Open HH	A#3	EX1
#23	084:OpenTriang	B3	---
#24	040:Crash Cym	C4	---
#25	044:Splash Cym	C#4	---
#26	084:OpenTriang	D4	---
#27	085:Tambourine	D#4	---
#28	083:MuteTriang	E4	---
#29	071:Open Conga	F4	---
#30	071:Open Conga	F#4	---
#31	072:Slap Conga	G4	---
#32	072:Slap Conga	G#4	---
#33	074:Mute Conga	A4	---
#34	074:Mute Conga	A#4	---
#35	073:Palm Conga	B4	---
#36	066:Lo Bongo	C5	---
#37	087:SynCowbell	C#5	---
#38	068:Slap Bongo	D5	---
#39	070:Syn Claves	D#5	---
#40	082:SynMaracas	E5	---
#41	098:Scratch Hi	F5	---
#42	108:FingerSnap	F#5	---
#43	099:Scratch Lo	G5	---
#44	139:Gt Scratch	G#5	---
#45	100:ScratchDb1	A5	---
#46	065:Agogo	A#5	---
#47	100:ScratchDb1	B5	---
#48	102:Mute Cuica	C6	---
#49	103:Open Cuica	C#6	---
#50	096:Zap 1	D6	---
#51	097:Zap 2	D#6	---
#52	094:Hand Claps	E6	---
#53	135:Pole	F6	---
#54	147:Bell Tree	F#6	---
#55	063:Syn Tom 2	G6	---
#56	063:Syn Tom 2	A6	---
#57	063:Syn Tom 2	B6	---
#58	063:Syn Tom 2	C7	---
#59	030:Syn Snare2	G8	---

DRUMKIT

ROM D.KIT1**GM Kit**

#	Inst	Key	Excl
#00	008:ProcesKick	C2	---
#01	036:Side Stick	C#2	---
#02	026:Rock Snare	D2	---
#03	094:Hand Claps	D#2	---
#04	020:LightSnare	E2	---
#05	059:Tom Lo	F2	---
#06	048:Tite HH	F#2	EX1
#07	059:Tom Lo	G2	---
#08	050:Pedal HH	G#2	EX1
#09	059:Tom Lo	A2	---
#10	049:Open HH	A#2	EX1
#11	058:Tom Hi	B2	---
#12	058:Tom Hi	C3	---
#13	040:Crash Cym	C#3	---
#14	058:Tom Hi	D3	---
#15	054:Ride Edge	D#3	---
#16	042:China Cym	E3	---
#17	055:Ride Cup	F3	---
#18	085:Tambourine	F#3	---
#19	044:Splash Cym	G3	---
#20	086:Cowbell	G#3	---
#21	040:Crash Cym	A3	---
#22	104:Vibraslap	A#3	---
#23	056:Ride Cym 1	B3	---
#24	067:Hi Bongo	C4	---
#25	066:Lo Bongo	C#4	---
#26	074:Mute Conga	D4	---
#27	071:Open Conga	D#4	---
#28	071:Open Conga	E4	---
#29	089:Hi Timbal	F4	---
#30	090:Lo Timbal	F#4	---
#31	065:Agogo	G4	---
#32	065:Agogo	G#4	---
#33	081:Cabasa	A4	---
#34	080:Maracas	A#4	---
#35	150:Whistle S	B4	EX2
#36	151:Whistle L	C5	EX2
#37	105:Guiro S	C#5	EX3
#38	106:Guiro L	D5	EX3
#39	069:Claves	D#5	---
#40	092:WoodBlock2	E5	---
#41	093:WoodBlock3	F5	---
#42	102:Mute Cuica	F#5	EX4
#43	103:Open Cuica	G5	EX4
#44	083:MuteTriang	G#5	EX5
#45	084:OpenTriang	A5	EX5
#46	081:Cabasa	A#5	---
#47	005:Real Kick	B1	---
#48	149:JingleBell	B5	---
#49	147:Bell Tree	C6	---
#50	107:Castanet	C#6	---
#51	036:Side Stick	D6	---
#52	154:Taiko Lo	D#6	---
#53	014:Snare 1	A1	EX6
#54	000:Fat Kick	G1	---
#55	016:Snare 3	F1	---
#56	001:Rock Kick	E1	---
#57	049:Open HH	F#1	EX1
#58	109:Timbales	G#1	---
#59	024:RollSnare1	A#1	EX6

ROM D.KIT2**Power Kit**

#	Inst	Key	Excl
#00	009:Metal Kick	C2	---
#01	036:Side Stick	C#2	---
#02	028:PowerSnare	D2	---
#03	094:Hand Claps	D#2	---
#04	027:GatedSnare	E2	---
#05	060:ProcessTom	F2	---
#06	048:Tite HH	F#2	EX1
#07	060:ProcessTom	G2	---
#08	050:Pedal HH	G#2	EX1
#09	060:ProcessTom	A2	---
#10	049:Open HH	A#2	EX1
#11	060:ProcessTom	B2	---
#12	060:ProcessTom	C3	---
#13	040:Crash Cym	C#3	---
#14	060:ProcessTom	D3	---
#15	054:Ride Edge	D#3	---
#16	042:China Cym	E3	---
#17	055:Ride Cup	F3	---
#18	085:Tambourine	F#3	---
#19	044:Splash Cym	G3	---
#20	086:Cowbell	G#3	---
#21	040:Crash Cym	A3	---
#22	104:Vibraslap	A#3	---
#23	056:Ride Cym 1	B3	---
#24	067:Hi Bongo	C4	---
#25	066:Lo Bongo	C#4	---
#26	074:Mute Conga	D4	---
#27	071:Open Conga	D#4	---
#28	071:Open Conga	E4	---
#29	089:Hi Timbal	F4	---
#30	090:Lo Timbal	F#4	---
#31	065:Agogo	G4	---
#32	065:Agogo	G#4	---
#33	081:Cabasa	A4	---
#34	080:Maracas	A#4	---
#35	150:Whistle S	B4	EX2
#36	151:Whistle L	C5	EX2
#37	105:Guiro S	C#5	EX3
#38	106:Guiro L	D5	EX3
#39	069:Claves	D#5	---
#40	092:WoodBlock2	E5	---
#41	093:WoodBlock3	F5	---
#42	102:Mute Cuica	F#5	EX4
#43	103:Open Cuica	G5	EX4
#44	083:MuteTriang	G#5	EX5
#45	084:OpenTriang	A5	EX5
#46	081:Cabasa	A#5	---
#47	007:Gated Kick	B1	---
#48	149:JingleBell	B5	---
#49	147:Bell Tree	C6	---
#50	107:Castanet	C#6	---
#51	036:Side Stick	D6	---
#52	154:Taiko Lo	D#6	---
#53	021:TightSnare	A1	---
#54	007:Gated Kick	G1	---
#55	026:Rock Snare	F1	---
#56	002:Ambi.Kick	E1	---
#57	049:Open HH	F#1	EX1
#58	109:Timbales	G#1	---
#59	023:Rev Snare	A#1	---

ROM D.KIT3**Analog Kit**

#	Inst	Key	Excl
#00	010:Syn Kick 1	C2	---
#01	037:Syn Rim	C#2	---
#02	029:Syn Snare1	D2	---
#03	095:Syn Claps	D#2	---
#04	020:LightSnare	E2	---
#05	062:SynTom1 Lo	F2	---
#06	051:CloseSynHH	F#2	EX1
#07	062:SynTom1 Lo	G2	---
#08	051:CloseSynHH	G#2	EX1
#09	062:SynTom1 Lo	A2	---
#10	052:Open SynHHA#2	EX1	---
#11	062:SynTom1 Lo	B2	---
#12	062:SynTom1 Lo	C3	---
#13	052:Open SynHHC#3	---	---
#14	062:SynTom1 Lo	D3	---
#15	054:Ride Edge	D#3	---
#16	042:China Cym	E3	---
#17	055:Ride Cup	F3	---
#18	085:Tambourine	F#3	---
#19	044:Splash Cym	G3	---
#20	087:SynCowbell	G#3	---
#21	040:Crash Cym	A3	---
#22	104:Vibraslap	A#3	---
#23	056:Ride Cym 1	B3	---
#24	067:Hi Bongo	C4	---
#25	066:Lo Bongo	C#4	---
#26	061:SynTom1 Hi	D4	---
#27	061:SynTom1 Hi	D#4	---
#28	061:SynTom1 Hi	E4	---
#29	089:Hi Timbal	F4	---
#30	090:Lo Timbal	F#4	---
#31	065:Agogo	G4	---
#32	065:Agogo	G#4	---
#33	081:Cabasa	A4	---
#34	082:SynMaracas	A#4	---
#35	150:Whistle S	B4	EX2
#36	151:Whistle L	C5	EX2
#37	105:Guiro S	C#5	EX3
#38	106:Guiro L	D5	EX3
#39	070:Syn Claves	D#5	---
#40	092:WoodBlock2	E5	---
#41	093:WoodBlock3	F5	---
#42	102:Mute Cuica	F#5	EX4
#43	103:Open Cuica	G5	EX4
#44	083:MuteTriang	G#5	EX5
#45	084:OpenTriang	A5	EX5
#46	081:Cabasa	A#5	---
#47	003:Crisp Kick	B1	---
#48	149:JingleBell	B5	---
#49	147:Bell Tree	C6	---
#50	107:Castanet	C#6	---
#51	036:Side Stick	D6	---
#52	154:Taiko Lo	D#6	---
#53	022:Ambi.Snare	A1	---
#54	006:Dance Kick	G1	---
#55	030:Syn Snare2	F1	---
#56	012:Syn Kick 3	E1	---
#57	052:Open SynHHF#1	EX1	---
#58	109:Timbales	G#1	---
#59	023:Rev Snare	A#1	---

ROM D.KIT4**Jazz Kit**

#	Inst	Key	Excl
#00	001:Rock Kick	C2	---
#01	036:Side Stick	C#2	---
#02	019:Soft Snare	D2	---
#03	094:Hand Claps	D#2	---
#04	015:Snare 2	E2	---
#05	059:Tom Lo	F2	---
#06	048:Tite HH	F#2	EX1
#07	059:Tom Lo	G2	---
#08	050:Pedal HH	G#2	EX1
#09	059:Tom Lo	A2	---
#10	049:Open HH	A#2	EX1
#11	058:Tom Hi	B2	---
#12	058:Tom Hi	C3	---
#13	040:Crash Cym	C#3	---
#14	058:Tom Hi	D3	---
#15	057:Ride Cym 2	D#3	---
#16	042:China Cym	E3	---
#17	056:Ride Cym 1	F3	---
#18	085:Tambourine	F#3	---
#19	044:Splash Cym	G3	---
#20	086:Cowbell	G#3	---
#21	040:Crash Cym	A3	---
#22	104:Vibraslap	A#3	---
#23	054:Ride Edge	B3	---
#24	067:Hi Bongo	C4	---
#25	066:Lo Bongo	C#4	---
#26	074:Mute Conga	D4	---
#27	071:Open Conga	D#4	---
#28	071:Open Conga	E4	---
#29	089:Hi Timbal	F4	---
#30	090:Lo Timbal	F#4	---
#31	065:Agogo	G4	---
#32	065:Agogo	G#4	---
#33	081:Cabasa	A4	---
#34	080:Maracas	A#4	---
#35	150:Whistle S	B4	EX2
#36	151:Whistle L	C5	EX2
#37	105:Guiro S	C#5	EX3
#38	106:Guiro L	D5	EX3
#39	069:Claves	D#5	---
#40	092:WoodBlock2	E5	---
#41	093:WoodBlock3	F5	---
#42	102:Mute Cuica	F#5	EX4
#43	103:Open Cuica	G5	EX4
#44	083:MuteTriang	G#5	EX5
#45	084:OpenTriang	A5	EX5
#46	081:Cabasa	A#5	---
#47	004:Punch Kick	B1	---
#48	149:JingleBell	B5	---
#49	147:Bell Tree	C6	---
#50	107:Castanet	C#6	---
#51	036:Side Stick	D6	---
#52	154:Taiko Lo	D#6	---
#53	025:RollSnare2	A1	EX6
#54	002:Ambi.Kick	G1	---
#55	017:Snare 4	F1	---
#56	003:Crisp Kick	E1	---
#57	049:Open HH	F#1	EX1
#58	109:Timbales	G#1	---
#59	024:RollSnare1	A#1	EX6

DRUMKIT

ROM D.KIT5**Bruch Kit**

#	Inst	Key	Excl
#00	001:Rock Kick	C2	---
#01	036:Side Stick	C#2	---
#02	035:Brush Tap	D2	---
#03	032:Brush Slap	D#2	---
#04	033:BrushSwish	E2	---
#05	064:Brush Tom	F2	---
#06	048:Tite HH	F#2	EX1
#07	064:Brush Tom	G2	---
#08	050:Pedal HH	G#2	EX1
#09	064:Brush Tom	A2	---
#10	049:Open HH	A#2	EX1
#11	064:Brush Tom	B2	---
#12	064:Brush Tom	C3	---
#13	040:Crash Cym	C#3	---
#14	064:Brush Tom	D3	---
#15	057:Ride Cym 2	D#3	---
#16	042:China Cym	E3	---
#17	056:Ride Cym 1	F3	---
#18	085:Tambourine	F#3	---
#19	044:Splash Cym	G3	---
#20	086:Cowbell	G#3	---
#21	040:Crash Cym	A3	---
#22	104:Vibraslap	A#3	---
#23	054:Ride Edge	B3	---
#24	067:Hi Bongo	C4	---
#25	066:Lo Bongo	C#4	---
#26	074:Mute Conga	D4	---
#27	071:Open Conga	D#4	---
#28	071:Open Conga	E4	---
#29	089:Hi Timbal	F4	---
#30	090:Lo Timbal	F#4	---
#31	065:Agogo	G4	---
#32	065:Agogo	G#4	---
#33	081:Cabasa	A4	---
#34	080:Maracas	A#4	---
#35	150:Whistle S	B4	EX2
#36	151:Whistle L	C5	EX2
#37	105:Güiro S	C#5	EX3
#38	106:Güiro L	D5	EX3
#39	069:Claves	D#5	---
#40	092:WoodBlock2	E5	---
#41	093:WoodBlock3	F5	---
#42	102:Mute Cuica	F#5	EX4
#43	103:Open Cuica	G5	EX4
#44	083:MuteTriang	G#5	EX5
#45	084:OpenTriang	A5	EX5
#46	081:Cabasa	A#5	---
#47	004:Punch Kick	B1	---
#48	149:JingleBell	B5	---
#49	147:Bell Tree	C6	---
#50	107:Castanet	C#6	---
#51	036:Side Stick	D6	---
#52	154:Taiko Lo	D#6	---
#53	032:Brush Slap	A1	EX6
#54	002:Ambi.Kick	G1	---
#55	108:FingerSnap	F1	---
#56	003:Crisp Kick	E1	---
#57	049:Open HH	F#1	EX1
#58	109:Timbales	G#1	---
#59	024:RollSnare1	A#1	EX6

ROM D.KIT6**Percussion Kit**

#	Inst	Key	Excl
#00	069:Claves	C2	---
#01	092:WoodBlock2	C#2	---
#02	086:Cowbell	D2	---
#03	091:WoodBlock1	D#2	---
#04	107:Castanet	E2	---
#05	076:Bayá 2	F2	---
#06	081:Cabasa	F#2	---
#07	075:Bayá 1	G2	---
#08	080:Maracas	G#2	---
#09	076:Bayá 2	A2	---
#10	081:Cabasa	A#2	---
#11	079:Tabla 3	B2	EX1
#12	078:Tabla 2	C3	EX1
#13	104:Vibraslap	C#3	---
#14	077:Tabla 1	D3	EX1
#15	083:MuteTriang	D#3	EX3
#16	013:Orch B.Drm	E3	---
#17	084:OpenTriang	F3	EX3
#18	105:Güiro S	F#3	EX2
#19	149:JingleBell	G3	---
#20	106:Güiro L	G#3	EX2
#21	147:Bell Tree	A3	---
#22	101:Thing	A#3	---
#23	080:Maracas	B3	---
#24	094:Hand Claps	C4	---
#25	095:Syn Claps	C#4	---
#26	099:Scratch Lo	D4	---
#27	098:Scratch Hi	D#4	---
#28	100:ScratchDbl	E4	---
#29	150:Whistle S	F4	EX4
#30	151:Whistle L	F#4	EX4
#31	072:Slap Conga	G4	---
#32	074:Mute Conga	G#4	---
#33	071:Open Conga	A4	---
#34	071:Open Conga	A#4	---
#35	102:Mute Cuica	B4	---
#36	103:Open Cuica	C5	---
#37	109:Timbales	C#5	---
#38	088:R-Timbal	D5	---
#39	089:Hi Timbal	D#5	---
#40	090:Lo Timbal	E5	---
#41	070:Syn Claves	F5	---
#42	087:SynCowbell	F#5	---
#43	108:FingerSnap	G5	---
#44	153:Taiko Hi	G#5	---
#45	154:Taiko Lo	A5	---
#46	097:Zap 2	A#5	---
#47	093:WoodBlock3	B1	---
#48	024:RollSnare1	B5	EX5
#49	025:RollSnare2	C6	EX5
#50	046:Orch Crash	C#6	EX6
#51	046:Orch Crash	D6	EX6
#52	161:Orch Hit	A7	---
#53	068:Slap Bongo	A#1	---
#54	065:Agogo	A1	---
#55	038:VocalSnr 1	G#1	---
#56	065:Agogo	G1	---
#57	067:Hi Bongo	E1	---
#58	066:Lo Bongo	F1	---
#59	085:Tambourine	F#1	---

ROM D.KIT7**Dance Kit**

#	Inst	Key	Excl
#00	006:Dance Kick	C2	---
#01	036:Side Stick	C#2	---
#02	030:Syn Snare2	D2	---
#03	094:Hand Claps	D#2	---
#04	022:Ambi.Snare	E2	---
#05	060:ProcessTom	F2	---
#06	048:Tite HH	F#2	EX1
#07	060:ProcessTom	G2	---
#08	050:Pedal HH	G#2	EX1
#09	060:ProcessTom	A2	---
#10	049:Open HH	A#2	EX1
#11	060:ProcessTom	B2	---
#12	060:ProcessTom	C3	---
#13	040:Crash Cym	C#3	---
#14	060:ProcessTom	D3	---
#15	054:Ride Edge	D#3	---
#16	042:China Cym	E3	---
#17	055:Ride Cup	F3	---
#18	085:Tambourine	F#3	---
#19	044:Splash Cym	G3	---
#20	086:Cowbell	G#3	---
#21	040:Crash Cym	A3	---
#22	104:Vibraslap	A#3	---
#23	054:Ride Edge	B3	---
#24	067:Hi Bongo	C4	---
#25	066:Lo Bongo	C#4	---
#26	074:Mute Conga	D4	---
#27	071:Open Conga	D#4	---
#28	071:Open Conga	E4	---
#29	089:Hi Timbal	F4	---
#30	090:Lo Timbal	F#4	---
#31	065:Agogo	G4	---
#32	065:Agogo	G#4	---
#33	081:Cabasa	A4	---
#34	080:Maracas	A#4	---
#35	150:Whistle S	B4	EX2
#36	151:Whistle L	C5	EX2
#37	105:Güiro S	C#5	EX3
#38	106:Güiro L	D5	EX3
#39	069:Claves	D#5	---
#40	092:WoodBlock2	E5	---
#41	093:WoodBlock3	F5	---
#42	102:Mute Cuica	F#5	EX4
#43	103:Open Cuica	G5	EX4
#44	083:MuteTriang	G#5	EX5
#45	084:OpenTriang	A5	EX5
#46	081:Cabasa	A#5	---
#47	002:Ambi.Kick	B1	---
#48	149:JingleBell	B5	---
#49	147:Bell Tree	C6	---
#50	107:Castanet	C#6	---
#51	036:Side Stick	D6	---
#52	154:Taiko Lo	D#6	---
#53	021:TightSnare	A1	---
#54	011:Syn Kick 2	G1	---
#55	018:PicloSnare	F1	---
#56	003:Crisp Kick	E1	---
#57	049:Open HH	F#1	EX1
#58	036:Side Stick	G#1	---
#59	023:Rev Snare	A#1	---

ROM D.KIT8**Orchestra Kit**

#	Inst	Key	Excl
#00	013:Orch B.Drm	C2	---
#01	036:Side Stick	C#2	---
#02	025:RollSnare2	D2	---
#03	107:Castanet	D#2	---
#04	025:RollSnare2	E2	---
#05	-- No Assign --	F2	---
#06	-- No Assign --	F#2	---
#07	-- No Assign --	G2	---
#08	-- No Assign --	G#2	---
#09	-- No Assign --	A2	---
#10	-- No Assign --	A#2	---
#11	-- No Assign --	B2	---
#12	-- No Assign --	C3	---
#13	-- No Assign --	C#3	---
#14	-- No Assign --	D3	---
#15	-- No Assign --	D#3	---
#16	-- No Assign --	E3	---
#17	152:Timpani	F3	---
#18	085:Tambourine	F#3	---
#19	044:Splash Cym	G3	---
#20	086:Cowbell	G#3	---
#21	040:Crash Cym	A3	---
#22	104:Vibraslap	A#3	---
#23	046:Orch Crash	B3	---
#24	067:Hi Bongo	C4	---
#25	066:Lo Bongo	C#4	---
#26	074:Mute Conga	D4	---
#27	071:Open Conga	D#4	---
#28	071:Open Conga	E4	---
#29	089:Hi Timbal	F4	---
#30	090:Lo Timbal	F#4	---
#31	065:Agogo	G4	---
#32	065:Agogo	G#4	---
#33	081:Cabasa	A4	---
#34	080:Maracas	A#4	---
#35	150:Whistle S	B4	EX2
#36	151:Whistle L	C5	EX2
#37	105:Güiro S	C#5	EX3
#38	106:Güiro L	D5	EX3
#39	069:Claves	D#5	---
#40	092:WoodBlock2	E5	---
#41	093:WoodBlock3	F5	---
#42	102:Mute Cuica	F#5	EX4
#43	103:Open Cuica	G5	EX4
#44	083:MuteTriang	G#5	EX5
#45	084:OpenTriang	A5	EX5
#46	081:Cabasa	A#5	---
#47	005:Real Kick	B1	---
#48	149:JingleBell	B5	---
#49	147:Bell Tree	C6	---
#50	107:Castanet	C#6	---
#51	036:Side Stick	D6	---
#52	154:Taiko Lo	D#6	---
#53	048:Tite HH	D#1	EX1
#54	049:Open HH	F1	EX1
#55	054:Ride Edge	F#1	---
#56	050:Pedal HH	E1	EX1
#57	-- No Assign --	D0	---
#58	-- No Assign --	G#1	---
#59	-- No Assign --	A#1	---

PATTERN

PRELOAD.SNG

#	PSET Name	Part	Track	Program Name	Key	Meas
00	Funk	Drum 1	10	132 Jazz Kit	F2	8
01	Funk	Drum 2	10	132 Jazz Kit	G2	8
02	Funk	Drum 3	10	132 Jazz Kit	A2	8
03	Funk	Fill 1	10	132 Jazz Kit	C3	3
04	Funk	Fill 2	10	132 Jazz Kit	C#3	3
05	Funk	Perc	11	129 GM Kit	D3	8
06	90's Soul	Drum 1	10	131 Analog Kit	F2	8
07	90's Soul	Drum 2	10	131 Analog Kit	G2	8
08	90's Soul	Drum 3	10	131 Analog Kit	A2	8
09	90's Soul	Fill 1	10	131 Analog Kit	C3	2
10	90's Soul	Fill 2	11	134 Perc Kit	C#3	2
11	90's Soul	Perc	10	131 Analog Kit	D3	2
12	J-Dance	Drum 1	10	135 Dance Kit	F2	8
13	J-Dance	Drum 2	10	135 Dance Kit	G2	8
14	J-Dance	Drum 3	10	135 Dance Kit	A2	8
15	J-Dance	Fill 1	10	135 Dance Kit	C3	2
16	J-Dance	Fill 2	10	135 Dance Kit	C#3	2
17	Jazz	Drum 1	10	132 Jazz Kit	F2	8
18	Jazz	Drum 2	10	132 Jazz Kit	G2	8
19	Jazz	Drum 3	10	132 Jazz Kit	A2	8
20	Jazz	Fill 1	10	132 Jazz Kit	C3	4
21	Jazz	Fill 2	10	132 Jazz Kit	C#3	4
22	-----					
23	Funk	Bass 1	2	D96 Thumb Bass	F#2	8
24	Funk	Bass 2	2	D96 Thumb Bass	G#2	8
25	Funk	Bass 3	2	D96 Thumb Bass	A#2	8
26	90's Soul	Bass 1	2	A96 Deep House#	F#2	8
27	90's Soul	Bass 2	2	A96 Deep House#	G#2	8
28	90's Soul	Bass 3	2	A96 Deep House#	A#2	8
29	J-Dance	Bass 1	2	B46 Synth Bass 3	F#2	8
30	J-Dance	Bass 2	2	B46 Synth Bass 3	G#2	8
31	J-Dance	Bass 3	2	B46 Synth Bass 3	A#2	8
32	Jazz	Bass 1	2	D06 Wooden You?	F#2	8
33	Jazz	Bass 2	2	D06 Wooden You?	G#2	8
34	Jazz	Bass 3	2	D06 Wooden You?	A#2	8
35	-----					
36	Funk	Piano	3	A31 TXPiano Tap	F3	8
37	Funk	Clav	4	G08 Clav	F#3	8
38	Funk	Brass	6	B72 Trump Ens.	G3	8
39	Funk	Guitar	7	B64 Funk Guitar	G#3	8
40	90's Soul	Piano	3	B81 Dyno Tines	F3	8
41	90's Soul	Org	4	A77 Green Eyes	F#3	8
42	90's Soul	Brass	6	B12 Pop Brass	G3	8
43	90's Soul	Mute Guitar	7	G29 Mute Guitar	G#3	8
44	90's Soul	Synth	9	A75 Air Fantasy	A3	8
45	J-Dance	Piano	3	B41 M1 Piano	F3	2
46	J-Dance	Power Chord	8	C14 Power Rock	F#3	8
47	J-Dance	Oburi	9	C08 Power Synth	G3	8
48	Jazz	Piano	3	A01 N264 Piano	F3	8
49	Jazz	Organ	4	A27 Jazz Organ	F#3	8
50	Jazz	Guitar	7	D54 Hollow Body	G3	8

RPPR.SNG

#	PSET Name	Part	Track	Program Name	Key	Meas
00	Pop Rock	Drum 1	10	130 Power Kit	F2	8
01	Pop Rock	Drum 2	10	130 Power Kit	G2	8
02	Pop Rock	Drum 3	10	130 Power Kit	A2	8
03	Pop Rock	Fill 1	10	130 Power Kit	C3	2
04	Pop Rock	Fill 2	10	130 Power Kit	C#3	2
05	Hard Rock	Drum 1	10	130 Power Kit	F2	8
06	Hard Rock	Drum 2	10	130 Power Kit	G2	8
07	Hard Rock	Drum 3	10	130 Power Kit	A2	8
08	Hard Rock	Fill 1	10	130 Power Kit	C3	2
09	Hard Rock	Fill 2	10	130 Power Kit	C#3	2
10	Latin	Perc 1	11	134 Perc Kit	F2	8
11	Latin	Perc 2	11	134 Perc Kit	G2	8
12	Latin	Perc 3	11	134 Perc Kit	A2	8
13	Latin	Dr	10	132 Jazz Kit	F2	8
14	Latin	Fill 1	11	134 Perc Kit	C3	1
15	Latin	Fill 2	10	132 Jazz Kit	C#3	1
16	70's Disco	Drum 1	10	130 Power Kit	F2	8
17	70's Disco	Drum 2	10	130 Power Kit	G2	8
18	70's Disco	Drum 3	10	130 Power Kit	A2	8
19	70's Disco	Fill 1	10	130 Power Kit	C3	2
20	70's Disco	Fill 2	10	130 Power Kit	C#3	4
21	Euro	Drum 1	10	135 Dance Kit	F2	8
22	Euro	Drum 2	10	135 Dance Kit	G2	8
23	Euro	Drum 3	10	135 Dance Kit	A2	8
24	Euro	Fill 1	10	135 Dance Kit	C3	1
25	Euro	Fill 2	10	135 Dance Kit	C#3	1
26	-----					
27	Pop Rock	Bass 1	2	A66 Rock Bass	F#2	8
28	Pop Rock	Bass 2	2	A66 Rock Bass	G#2	8
29	Pop Rock	Bass 3	2	A66 Rock Bass	A#2	8
30	Hard Rock	Bass 1	2	A66 Rock Bass	F#2	8
31	Hard Rock	Bass 2	2	A66 Rock Bass	G#2	8
32	Hard Rock	Bass 3	2	A66 Rock Bass	A#2	8
33	Latin	Bass 1	2	A56 Clean Bass	F#2	8
34	Latin	Bass 2	2	A56 Clean Bass	G#2	8
35	Latin	Bass 3	2	A56 Clean Bass	A#2	8
36	70's Disco	Bass 1	2	B56 Velo Pick	F#2	8
37	70's Disco	Bass 2	2	B56 Velo Pick	G#2	8
38	70's Disco	Bass 3	2	B56 Velo Pick	A#2	8
39	Euro	Bass 1	2	B26 Dance Bass	F#2	8
40	Euro	Bass 2	2	B26 Dance Bass	G#2	8
41	Euro	Bass 3	2	B26 Dance Bass	A#2	8
42	-----					
43	Pop Rock	Syn Piano	3	C23 Operators	F3	8
44	Pop Rock	Organ	4	A57 Classic"B"	F#3	8
45	Pop Rock	Guitar	7	B74 Rock Chuga	G3	4
46	Pop Rock	Power Chord	8	B04 Rock On!!!	G#3	8
47	Hard Rock	Piano	3	A01 N264 Piano	F3	8
48	Hard Rock	Organ	4	C31 Gospel Org	F#3	8
49	Hard Rock	Guitar	8	B74 Rock Chuga	G3	8
50	Hard Rock	Power Chord	7	B04 Rock On!!!	G#3	8
51	Latin	Piano	3	A01 N264 Piano	F3	8
52	Latin	Trumpet	6	B12 Pop Brass	F#3	8
53	Latin	Brass	4	B72 Trump Ens.	G3	8
54	70's Disco	Piano	3	A01 N264 Piano	F3	8
55	70's Disco	Strings	5	G49 Marcato	F#3	8
56	70's Disco	Horn	6	G61 French Horn	G3	8
57	70's Disco	Guitar	7	G29 Mute Guitar	G#3	8
58	Euro	Lead Stub	3	D08 Lead Stab	F3	8
59	Euro	Strings	5	A05 N-Strings	F#3	8
60	Euro	Oburi	9	C87 Air Vox	G3	8

Demo Song

Song No.	Song Name	performed by	SNG File
S0	Music Lab	Taiki Imaizumi	PRELOAD.SNG (Factory set data)
S1	MissionMan	John Lehmkuhl	
S2	Ghost Page	Shige Kawagoe	

RPPR Demo

Song No.	Pattern Set No.	Pattern Set Name	SNG File	PST File
S3	PS3	Funk	PRELOAD.SNG (Factory set data)	PRELOAD.PST (Factory set data)
S4	PS4	90's Soul		
S5	PS5	J-Dance		
S6	PS6	Jazz	RPPR.SNG	RPPR.PST
S0	PS0	Pop Rock		
S1	PS1	Hard Rock		
S2	PS2	Latin		
S3	PS3	70's Disco		
S4	PS4	Euro		

For playing, match the Song No. and Pattern Set No. as shown in the above tables.

By loading RPPR.SNG and RPPR.PST, you can try out RPPR Pattern Sets different than the factory set data.



If PRELOAD.PCG (the factory set data) is not loaded, the above-listed demo songs and the RPPR Demo will not play correctly.

Files on the included disk

File Name	Type	Comment
PRELOAD.PCG	factory set PCG file	Load this when you wish to use the factory set data.
PRELOAD.SNG	factory set SNG file	
PRELOAD.PST	factory set PST file	
RPPR.SNG	SNG file for RPPR demo	A RPPR demo file different than the preloaded data.
RPPR.PST	PST file for RPPR demo	
GMDEMO1.MID	GM format Standard MIDI File	SMF format demo songs for playback using the GM sounds.
GMDEMO2.MID		
I3CDBANK.PCG	PCG file containing i3 C/D bank Programs	These are the factory set programs for banks C/D of the i3.
INITIAL.PCG	initialized PCG file	Load these files when you wish to initialize the data.
INITIAL.SNG	initialized SNG file	
INITIAL.PST	initialized PST file	

NOTICE

KORG products are manufactured under strict specifications and voltages required by each country. These products are warranted by the KORG distributor only in each country. Any KORG product not sold with a warranty card or carrying a serial number disqualifies the product sold from the manufacturer's/distributor's warranty and liability. This requirement is for your own protection and safety.

KORG KORG INC.

15 - 12, Shimotakaido 1 - chome, Suginami-ku, Tokyo, Japan.