



File Name : KT76 & 88 LOGO.eps
Title : KT76 & 88 LOGO
Creator : FreeHand 3.1
CreationDate : 8/19/94 9:33 AM

Musician's Manual

Version 1.5

KT Musician's Manual:

Written, designed, and illustrated by: Tom Tracy, Bill Whipple

Copyright © 1994, 1995
ENSONIQ® Corp
155 Great Valley Parkway
Box 3035
Malvern, PA 19355-0735
USA

Printed in U.S.A.

All Rights Reserved

Please record the following information:

Your Authorized ENSONIQ Dealer: _____ Phone: _____

Your Dealer Sales Representative: _____

Serial Number of Unit: _____ Date of Purchase: _____

Your Authorized ENSONIQ Dealer is your primary source for service and support. The above information will be helpful in communicating with your Authorized ENSONIQ Dealer, and provide necessary information should you need to contact ENSONIQ Customer Service. If you have any questions concerning the use of this unit, please contact your Authorized ENSONIQ Dealer first. For additional technical support, or to find the name of the nearest Authorized ENSONIQ Repair Station, call ENSONIQ Customer Service at (610) 647-3930 Monday through Friday 9:30 AM to 12:15 PM and 1:15 PM to 6:30 PM Eastern Time. Between 1:15 PM and 5:00 PM we experience our heaviest call load. During these times, there may be delays in answering your call.

This manual is copyrighted and all rights are reserved by ENSONIQ Corp. This document may not, in whole or in part, be copied, photocopied, reproduced, translated, or reduced to any electronic medium or machine readable form without prior written consent from ENSONIQ Corp. The KT-76/KT-88 software/firmware is copyrighted and all rights are reserved by ENSONIQ Corp.

Although every effort has been made to ensure the accuracy of the text and illustrations in this manual, no guarantee is made or implied in this regard.

IMPORTANT:

"This equipment generates and uses radio frequency energy and if not installed and used properly, that is, in strict accordance with the manufacturer's instructions, may cause interference to radio and television reception. It has been designed to comply with the limits for a Class B computing device in accordance with the specifications in Subpart J of Part 15 of FCC rules, which are designed to provide reasonable protection against such interference in a residential installation. However, there is no guarantee that interference will not occur in a particular installation. If this equipment does cause interference to radio or television reception, which can be determined by turning the equipment off and on, the user is encouraged to try to correct the interference by one or more of the following measures."

- * reorient the receiving antenna
- * relocate the instrument with respect to the receiver
- * move the instrument away from the receiver
- * plug the instrument into a different outlet so that the instrument and receiver are on different branch circuits

"If necessary, the user should consult the dealer or an experienced radio/television technician for additional suggestions. The user may find the following booklet prepared by the Federal Communications Commission helpful: 'How to Identify and Resolve Radio-TV Interference Problems.' This booklet is available from the U.S. Government Printing Office, Washington, D.C. 20402. Stock No. 004-000-00345-4."

CAUTION! Danger of explosion if battery is incorrectly replaced. Replace only with the same or equivalent type recommended by the manufacturer. Discard used batteries according to manufacturer's instructions.

In order to fulfill warranty requirements, the KT-76/KT-88 should be serviced only by an Authorized ENSONIQ Repair Station. The ENSONIQ serial number label must appear on the outside of the unit, or the ENSONIQ warranty is void.

- ENSONIQ, KT-76, KT-88, ASR-10, TS-10, TS-12, DP/4, SoundFinder, TransWave, and Poly-Key are trademarks of ENSONIQ Corp.
- All other trademarks are property of their respective owners.
- Some waves were looped with Infinity software from Jupiter Systems.



Table of Contents

List of Tips

Introduction

- Welcome!.....i
- About the KT-76/KT-88.....i
- Clean Up and Maintenanceii
- Center Supported Stands.....ii
- About The Manuals.....ii
- Power.....iii
- Polarization and Grounding.....iii
- Ground Loops.....iv
- AC Line Conditioning.....iv
- Guidelines for using the KT.....v
- Temperature Guidelines.....v
- Amplification Guidelines.....v
- Be Careful!
-
- vi
- Amplifying Your KT Through a Home Stereo System
-
- vi
- Powering Up Your KT In a MIDI Configuration
-
- vi
- Battery Replacement Guidelines.....vii
- Card Battery Replacement.....vii
- Reinitializing the KT.....viii
- To Reinitialize the KT.....viii
- How to Use this Manual.....ix
- Page Locations.....ix
- Single Digit Page Locations.....ix
- Button Names.....x
- Color-Coding on the Front Panel.....x
- Using the Color-Coded Text
-
- x
- Available Options for Your KT.....xi
- Where to Find More Help.....xi

Section 1 — Controls & Basic Functions

- Rear Panel Connections.....1
- The Front Panel Controls.....3
- Color-Coding Scheme.....3
- Direct-Dialing Banks.....4

More About the Transpose Keyboard Function

.....	
9	
PCM CIA Memory Cards.....	10
Headphones.....	10
Performance Controllers.....	11
Selecting Sounds.....	12
Selecting r:DRUM ROM Sounds.....	12
Sound Memory Configuration.....	13
Choosing Internal, ROM, and Card Sounds	14
SoundFinder™ Feature	15
Selecting Sequences/Presets or Songs	16
Sequencer Memory Configuration	16
Play the Demo Song.....	16
Choosing Internal, ROM, and Card Sequences/Presets/Songs	17
Using Parametric Programming.....	18
Changing a Parameter (Data Editing).....	18
To Change a Parameter	19
Multiple Parameters	19
Section 2 — System • MIDI Parameters	
Entering System • MIDI Mode	21
Exiting System • MIDI Mode.....	21
System Parameters.....	21
Tune/Bnd/PTbl.....	21
Various ROM System Pitch-Tables	
.....	
22	
Touch/Pressure.....	25
The KT Velocity Response Curves (Touch)	
.....	
26	
Velocity Curve Diagram	
.....	
26	
FtswL/FtswR.....	29
Latching Pressure with Sustain or Sostenuto	
.....	
29	
CV-Pedal/Voice Muting.....	30
MIDI Parameters	31
Base Channel/Status	31
Base Channel Pressure.....	32
MIDI Mode/Xctrl.....	33
Using Global Controllers in MONO Mode	
.....	
34	

Controllers/Prog Change	35
Program Changes in the KT	35
Bank Select and Program Change Implementation	
.....	
36	
Selecting a New Sound and its Effect from MIDI.....	36
SysEx/ID/Song Select.....	37
MIDI TrkName/MIDI Loop.....	38
Section 3 — Understanding Effects	
Understanding KT Effects.....	39
Sound (Standard and Drum) Effects	39
Preset/Sequence/Song Effects.....	39
What is an Algorithm?	40
Signal Routing Between Effects	40
When are New Effects Loaded into the ESP Chip?.....	40
Programming Effect Algorithms.....	41
Selecting Effect Algorithms	42
Effects Mixing.....	42
The Effects Busses	42
Single Function Effect Mixer	43
Multiple Function Effect Mixer	43
Routing Sounds to Effects in Sequence/Preset Mode	44
Controllers Routed to Effects.....	44
Reverb Variations.....	45
About the Decay Bias.....	45
Effect Modulators.....	46
Modulators that can be applied to the effects.....	46
Ramps	47
Section 4 — Effect Parameters	
About Effect Parameters	49
Effect Modulation Parameters.....	49
DRY/BYPASSED	49
DUAL EQ+REVERB	50
WARM CHAMBER	52
8-VOICE CHORUS	53
EQ-CHORUS+REVERB.....	54
EQ-DDL+REVERB.....	55
DDL-CHORUS+REVB.....	56
ENVCF-CHO+REVERB	57
FLANGER+REVERB	59
PHASER+REVERB.....	60
ROTARY SPKR+REVB.....	61
FL-CMP-DIST+REVB	63
DISTWAH-CHO+REVB.....	65

Section 5 — Understanding Sounds

What is a KT Sound?.....	67
Understanding Voices and Polyphony.....	67
Using the Compare Button/LED.....	68
Using the Edit Buffer.....	68
To Abandon Your Edits.....	68
Saving a New Sound Into Memory.....	69
To Save a Sound.....	69
Copying an Existing Sound to Another Location.....	69
KT Standard Sound Configuration.....	70
KT Drum Sound Configuration.....	71
Selecting Edit (Drum) Sound Mode.....	72
Using Modulation.....	73
About Modulation.....	73
To Select a Modulator.....	73
To Control Modulation Amount.....	73
Specifying a Modulation Source.....	74
ENV 1, ENV 2, ENV 3 — KT Standard Sound Envelopes.....	77

Section 6 — Standard Sound Parameters

Edit (Standard) Sound Mode.....	79
Wave Pages (00 - 05)	79
EditVOICE/Voice Status	79
Wave Class/Wave Name.....	81
Wave Name.....	81
KT Standard Sound ROM Wave Catalog.....	82
Delay Time/Direction	83
Start Index/ModSource/Mod Amount.....	83
Sample Shift/Mode.....	84
Voice Restrike Decay Time	85
SoundFinder Type.....	86
Change Sound Mode	87
Oct/Semi/Fine	88
Env1/LFO/Mod.....	88
Keyboard Pitch Tracking	89
Glide/Glide Time.....	90
Levels/Time.....	91
LevV/AtckV/VelCurv	92
Mode/KeyboardTrk	93
Mode (Env 3) — Voice Triggering	
.....	
93	
Stealing Notes	
.....	
93	
Press ENTER to select defaults.....	95
KT Default Envelope Values	96
LFO Pages (30 - 32).....	97
LFO Rate/Noise Rate	97
Depth/Dlay/Mod.....	98
Wave/Restart.....	98
Filters Pages (40 - 44)	100
Filter1/Filter2.....	100
FC1 Cutoff/Envelope2	100
FC1 Keyboard/Mod	101
FC2 Cutoff/Envelope2	101
FC2 Keyboard/FC1 Mod·FC2	101
Editing the Filters.....	102
More About Filters.....	102
Env2 (50-53) and Env3 Pages (60-63).....	104
Output Pages (70 - 73)	104
Vol/Mod.....	104
KeybdScale/KeyRange	105
Setting a Keyboard Zone	
.....	
107	

Table of Contents

Output Bus/Priority108
Pan/Mod Source/Mod Amount109
Vel Window109

Section 7 — Drum Sound Parameters	
Edit (Drum) Sound Mode	111
Wave Pages (00 - 05)	111
Key Range/Wave Name	111
Creating “Holes” in the Key Map	
.....	
112	
Wave Class/Wave Name.....	113
KT Drum Sound ROM Wave Catalog.....	114
Direction	115
Press ENTER to Set GM Map	115
The “Hidden” ROM General MIDI Drum Map	116
Press ENTER to Set Ensoniq Map.....	117
Change Sound mode	117
Pitch Pages (10 - 11)	118
Oct/Semi/Fine	118
Keyboard Pitch Tracking	118
Filter Page.....	119
Fc Cutoff/LevV	119
Amp Pages	119
Gate Time/Release Time.....	119
LevV/Mode	120
Stealing Notes.....	120
Output Pages (70 - 71)	121
Vol/Pan.....	121
Output Bus/VelCurv.....	122
Creating a Custom Drum Kit	123
To Edit the Voices.....	123
Setting Key Ranges	124
Saving Your Edited Drum Kit.....	125
Section 8 — Understanding Presets	
What is a Preset?.....	127
Selecting Presets	127
How Many Presets are Available in the KT?	127
What is the Difference Between Presets and Sequences?.....	128
What Are Tracks?.....	129
Three ways to create a preset	130
To create a preset using the default preset.....	130
To Build your own preset	130
To modify an existing preset.....	131
Layering Sounds with the Track Buttons	132
Using Effects With Performance Presets	132
Using the Replace Track Sound Function.....	133
Replacing the Sound on a Track	133
Using SoundFinder in Presets Mode.....	133
Replacing the Sound along with its Effect on a Track	134

A Note about Replacing Sounds Used by Sequences/Presets.....	135
Using Card Sounds in a Seq/Preset or Song.....	135
About Edit Track (Performance) Parameters.....	136
Using the Layer Lock Feature	137
About the “Save Changes?” Page	
.....	
138	
Using the Make Default Preset Button.....	139
To Play The Demo.....	139
To Make a Default Preset Template	139
To Copy Preset Data.....	141
About the KT ROM Presets	142
List of ROM Presets	142
rPSET00 — MIDI-Blend	142
rPSET01 — OhSoSweet-Rhodes.....	142
rPSET02 — AcBass/Kybrds(i).....	143
rPSET03 — ElBass/Kybrds(i).....	143
rPSET04 — SynBass/Kbds(i).....	143
rPSET05 — ElecBass/Gtrs(i).....	143
rPSET06 — Pno/SoloHorns(i).....	144
rPSET07 — TinePno/Horns(i).....	144
rPSET08 — PnoStr/Orch (i).....	144
rPSET09 — Wedding Ceremony.....	144
Section 9 — Preset/Track Parameters	
Vol/Pan.....	145
Output.....	146
KeyRange	147
Performance Tip — Creating Keyboard Splits	148
Transpose	148
Chan/Prog.....	149
Program Changes in the KT	149
Bank Select and Program Change Implementation	
.....	
150	
Selecting a New Sound and its Effect from MIDI.....	150
Status.....	151
Pressure	152
Sustain Pedal.....	153
Timbre.....	154
Release	154
Section 10 — Understanding the Sequencer	
Digital Sequencing.....	155
What is a Sequence?.....	156
What is a Song?.....	156
About Sequencer Memory	157

Card Sequencer Memory	157
Sequencer “Transport Controls”	158
Sequencer Status.....	159
Select Sequence Mode Pages	160
Selecting a Sequence or Song.....	160
Choosing Internal, ROM, and Card Sequences/Presets/Songs	161
Playing Sequences and Songs.....	161
Creating a New Sequence or Song.....	162
Erasing All Sequencer Memory	164
Recording a Sequence.....	165
The KEEP NEW/OLD Page	167
Re-recording a Track.....	168
Playing along with a Sequence/Auditioning New Sounds and Effects...169	
Recording Program Changes into the Sequencer.....	169
About the “Save Changes?” Page.....	170
Recording MIDI Tracks.....	171
Mixing, Muting and Soling Tracks (Track Volume Functions).....	172
Routing Sounds to Effects in Sequence/Preset Mode	173
Controllers Routed to Effects.....	173
Working in Song Mode	174
Assembling a Song.....	174
To assemble a song	174
Switching Effects in Song Mode.....	176
Song Tracks	177
Viewing Sequence Tracks in Song Mode.....	178
Mixing Down Sequence and Song Tracks in Song Mode	178
To Record Mix or Pan Changes to Sequence Tracks in a Song	178
To Record Mix or Pan Changes to a Song Track	179
More About Mixdown Mode	180
Delay Times/Tempo BPM Chart.....	180
Section 11 — Sequencer Parameters	
Locate Pages (00 - 03).....	183
SEQ (or SONG) Location/Bar/Beat.....	183
Song Locate	
.....	
184	
SEQ (or SONG) PUNCH IN	185
Edit Times in Song Mode.....	185
Setting the Edit Times in Real Time	186
SEQ (or SONG) PUNCH OUT	186
Auto Punch/Tempo	187
Tap Tempo	187
Song Tempo Offset.....	187
Sequencer Control Pages.....	188
Loop/Countoff.....	188
Step Entry/Record.....	188

To enter Step Entry recording.....	188
Auto Punch/Clock.....	191
Song uses effect from.....	191
Song Edit Tracks Displayed.....	192
SaveChangesMode.....	192
About the “Save Changes?” Page	
.....	
193	
Current Seq Bank Free Memory.....	194
Press ENTER to Erase Seq Memory	194
Click Pages (20 - 22)	195
Click/Interval.....	195
Click Volume/Click Pan.....	195
Tempo.....	195
Song Commands Pages (30 - 36)	196
Create SONG/Pset.....	196
Copy Song.....	197
Erase SONG/Pset.....	198
Song Information.....	198
Rename SONG/Pset.....	199
Copy Preset Data.....	199
Edit Song Steps.....	200
To Edit Song Steps	
.....	
200	
Import Song	203
Sequence Commands Pages.....	205
Create SEQ/Pset.....	205
Copy Sequence	206
Erase SEQ/Pset.....	207
Sequence Info.....	208
Rename SEQ/Pset.....	208
Copy Preset Data.....	209
Append Sequence	210
Change Length	211
Import Sequence.....	212
Track Commands Page.....	214
Setting the Track Range — Using the Track Range Function.....	214
To Set the Track Range.....	214
Event Edit Track.....	215
Event Locating Display for Prog Changes	217
Event Locating Display for All Events, Key Events and Key Pressure.....	217
AUDITION, INSERT and REMOVE.....	218
Copy Track.....	219
Erase Track.....	220
Merge Track	221
Transpose Track.....	222

Shift Track223
Scale Track.....224
Filter Events225
About the COPY Filter Mode.....226
Quantize Track227
(Track) Status228

Section 12 — The MIDI Connection

About MIDI.....	229
Controlling Remote MIDI Devices from the KT — MIDI Connections....	229
Setting up Remote MIDI Devices to Receive MIDI from the KT	230
Creating a Sequence/Presets For Controlling Remote MIDI Sound Sources.....	230
Setting Track Parameters for MIDI Controller Application	231
Using External MIDI Sequencers.....	232
Connecting the KT to a computer (or other MIDI sequencer).....	232
Selecting MULTI Mode — Receiving on up to 8 MIDI Channels.....	232
Assigning MIDI Reception Channels.....	233
Using the KT with a Drum Machine	234
To Sync a Drum Machine to the KT	234
To Sync the KT to a Drum Machine	234
To Sequence a Drum Machine from a Track of the KT	235
Song Position Pointers.....	235
MIDI Song Selects	235
Using the KT with a MIDI Guitar Controller.....	236
What is General MIDI?.....	237
Sound Map.....	237
Percussion.....	237
GS/MT-32 Compatibility.....	237
Other General MIDI Requirements	237
Why use General MIDI?.....	238
General MIDI Sound Map	239
GM and GS Percussion Key Maps (Channel 10)	240
Using General MIDI in the Real World	242
Using KT General MIDI Sounds with an External GM Sequencer.....	242
Connecting the KT keyboard to a computer (or other General MIDI sequencer).....	242
Enabling General MIDI on the KT.....	243
To Enable General MIDI	243
MIDI Out in General MIDI Mode.....	243
KT General MIDI Parameters.....	244
Track/Channel Number	244
GM Sound Number	244
Receive Status	244
Manually Assigning GM Sounds to Each MIDI Channel.....	245
General MIDI “All Notes Off” button.....	245
System and MIDI Control Settings in GM Mode	245
Disabling General MIDI.....	246
To Disable General MIDI	246
Enabling/Disabling General MIDI with System Exclusive Messages.....	246
More about SysEx Messages.....	246
Sound Canvas MT-32 Mode Program Change Map.....	247
MIDI Controller Implementation in General MIDI Mode.....	248
General MIDI Mode Controller Implementation Chart.....	248

Section 13 — Storage

Memory Card Storage	249
Installing the Battery in a RAM Card.....	249
Memory Card Configurations.....	250
Formatting a Blank Memory Card.....	250
More about PCMCIA RAM Memory Cards	250
SOUNDS.....	251
Copying Sounds Between Internal and Card Memory	251
SEQUENCES.....	252
Saving Sequencer Data to a PCMCIA Memory Card.....	252
About Sequence Memory.....	252
MIDI Sys-Ex Storage.....	253
What are System Exclusive Messages?	253
“Generic” System Exclusive Storage.....	253
Sending MIDI Sys-Ex Messages to another KT or to a Storage Device.....	253
SOUND DATA	254
SEQUENCER DATA	255
Receiving MIDI Sys-Ex Messages.....	256
Storage Prompts and Error Messages.....	257

Appendix

KT MIDI Implementation	I
Registered Parameters.....	I
MIDI Implementation Chart.....	II

Index

Parameter Reference Card

List of Tips

Viewing the Edit Pages Within a Group Using the 0-9 Buttons.....	5
Using the Value Buttons to Scroll Through Sounds	12
Using SoundFinder to Replace Sounds with their Effects	15
Using CUSTOM Settings to Define Your Own Sound Types.....	15
Setting the Modulation Amount to Zero	18
Changing Pitch-Tables while the Sequencer is Playing	22
Selecting Effects Quickly to Avoid the Delay	41
Using Mod Controls to Change Volume in Real Time.....	49
Saving an Edited Sound to its Current Sound Location.....	69
Setting the Modulation Amount to Zero	73
Setting the Restrike Time to Eliminate Clicking Sounds.....	85
Using the LFO as a Gated Modulator	99
Using Volume Modulators to Create Voice Crossfading.....	104
A Quick Way to Create Blank Drum Map Ranges.....	112
Quick Way to Save Changes in Select Seq/Preset Mode	138
Using the Foot Switch for Hands-Free Punch Ins	168
Auditioning the Sequence with Different Effects.....	169
Quick Way to Save Changes in Select Seq/Preset Mode	170
Toggling between Sequence and Song Tracks.....	178
Recording Dynamic Volume Changes.....	180
Using Modulators in Real Time to Create Poly-Rhythms.....	181
Disabling Recording in Step Entry Mode.....	190
Toggling between Song and Sequence Tracks.....	192
Quick Way to Save Changes in Select Seq/Preset Mode	193
Moving Single Key Events that may be Off-Time.....	218
Using Headphones in General MIDI mode.....	242
“Music-Minus-One” Applications.....	244
How to Replace the Card Battery without Loosing its Contents.....	249
Erasing RAM Memory Cards.....	250

List of Tips

Welcome!

Congratulations, and thank you for your purchase of the ENSONIQ KT-76/KT-88 keyboard. ENSONIQ redefines state-of-the-art performance with the latest addition to its family of synthesizers — the KT-76/KT-88. With 64-voice polyphony and a 76-key weighted action keyboard, the KT gives musicians the sound and feel of a real piano — along with all the benefits of a MIDI synthesizer. It's the ultimate instrument for performance, whether you're playing at home, in the studio, at church, or on stage. Once you experience its feel and response and hear the authentic, rich sounds, you'll be convinced that the KT truly offers you the keys to performance.

About the KT-76/KT-88

The KT breaks the sound barrier with 64-voice polyphony!

- Play bigger chords and more sustained notes without inhibiting your performance.
- Hear more intricate sounds.
- Create richer, warmer layers.
- Fully orchestrate your sequences.
- Play live over sequencer or General MIDI music playback.

The KT has the sounds you need — whatever your musical style:

- 308 onboard sounds from basics to exotic, including the full GM sound set.
- 13 state-of-the-art effect algorithms with real time modulation.
- Two sampled pianos in wave ROM (Read Only Memory).
- Even more sounds are available with the ENSONIQ KTC Series sound cards.
- SoundFinder™ allows you to scroll through sounds by musical category — whether in RAM (Random Access Memory), ROM, or on an expansion card.

The KT offers incredible performance control capabilities:

- The weighted-action mechanism simulates a real piano hammer for the same feel and dynamic response you get when playing your favorite acoustic piano.
- 14 velocity curves and 4 pressure settings — to match your playing style.
- The same versatile and easy-to-use controls used for the KT's sounds also make it the perfect master controller for other MIDI gear.
- The Make Default Preset button allows for instant configuration of internal and MIDI splits and layers.
- The Transpose Keyboard function allows for transposing music to any key — instantly.
- An excellent sound source for playing back MIDI data received from any General MIDI device.
- Ergonomically designed Pitch and Mod wheels for easy, comfortable reach while playing.
- Optional CV-P-1 Control Voltage Pedal allows for real-time volume control or modulation.
- Optional SW-10 Dual Foot Switch allows for sustain, sostenuto, and sequencer control.
- The optional MS-1 Music Stand will hold everything from single sheet music to large songbooks.

The KT gives you advanced yet easy-to-use sequencing features:

- Onboard 16-track sequencer.
- Develop your ideas into fully orchestrated songs with user-friendly editing features.
- For increased sequencer memory, use industry standard PCMCIA RAM cards (the same used by many notebook computers), and record and play your sequences directly to and from the card.

Storage Capabilities:

- MC-512 PCMCIA RAM Cards can be used to store both sound and sequencer data.
- Sounds and sequencer data can also be saved via MIDI System Exclusive to any remote MIDI device that accepts and stores such data.

Clean Up and Maintenance

Only clean the exterior of your KT with a soft, lint-free, dry (or slightly damp) cloth. You can use a slightly dampened cloth (with a mild neutral detergent) to remove stubborn dirt, but make sure that the KT is thoroughly dry before turning on the power. Never use alcohol, benzene, volatile cleaners, solvents, abrasives, polish or rubbing compounds.

Center Supported Stands

With the KT, or any weighted-action keyboard, we highly recommend that you do not use center-supported column-type keyboard stands. Weighted keyboards are too heavy, too long, and usually require greater playing force to be exerted on them. They will be unstable on center-supported column-type stands.

About The Manuals

This manual covers two different products, the KT-76 and the KT-88. The KT-76 has a 76 note keyboard, whereas the KT-88 has an 88 note keyboard. In this manual, when there are notable differences, the keyboards will be specifically addressed as the KT-76 and the KT-88. When the text pertains to both products, they will be referred to as KT.

If you're anxious to plug your KT in and get playing, we recommend following the KT Quick-Start Guide. It is designed to give you a head start at using and understanding the major features of the KT keyboard. After you've finished the Quick-Start Guide, you'll be on the way to using the KT to its fullest potential.

The Musician's Manual is your guide to understanding the KT in detail. The remainder of this section contains important safety and set-up information. After the initial "I just gotta hear it" phase has passed and you're ready to utilize the full potential of the KT, please take the time to read the sections on programming, sequencing, and storage. They'll provide valuable information and tips that will speed up the learning process and enhance your enjoyment of the KT.

Thank you again for choosing ENSONIQ. Enjoy the music!

Power

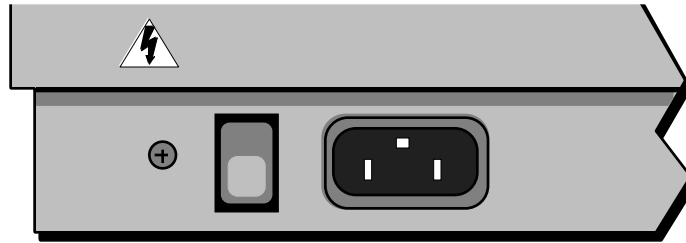

Insert the line cord into the line receptacle on the rear panel of the KT, next to the power switch. Plug the other end of the cable into a grounded AC outlet (the proper voltage for your KT is listed on the Serial Number label on the rear panel). Turn the KT power on and make sure the display lights up. If not, check your connections and power source.

Polarization and Grounding

Like many modern electrical devices, your ENSONIQ product has a three-prong power cord with earth ground to ensure safe operation. Some products have power cords with only two prongs and no earth ground. To ensure safe operation, modern products with two-prong power cords have polarized plugs that can only be inserted into an outlet the proper way.

Some products, such as older guitar amplifiers, do not have polarized plugs and can be connected to an outlet incorrectly. This may result in dangerously high voltages on the audio connections, which could cause you physical harm or damage any properly grounded equipment to which they are connected, such as your ENSONIQ product.

To avoid shock hazards or equipment damage, we recommend the following precautions:

- If you own equipment with two-pronged power cords, check to see if they are polarized or non-polarized. You might consider having an authorized repair station change any non-polarized plugs on your equipment to polarized plugs to avoid future problems.

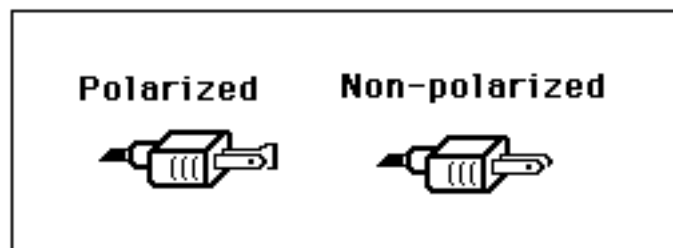

- Exercise caution when using extension cords or plug adapters. Proper polarization should always be maintained from the outlet to the plug. The use of polarized extension cords and adapters is the easiest way to maintain proper polarity.
- Whenever possible, connect all products with grounded power cords to the same outlet ground. This will ensure a common ground level to prevent equipment damage and minimize hum in the audio output.

AC outlet testers are available from many electronic supply and hardware stores. These can be used to check for proper polarity of outlets and cords.

Ground Loops

Sometimes currents flowing through the ground line generate a signal seen by another part of the circuit sharing the same ground. In other words, if there are two identical signal paths within a circuit, they can form a loop which can result in hum and/or noise. If you are using equipment that has 3-prong “grounded” AC power cords, you may suffer from a ground loop resulting from the interconnection of this equipment. The following diagram shows how cascading or “chaining” the output of one 3-prong grounded system into the input of another 3-prong grounded system with a standard, unbalanced 2-conductor cord (like a 1/4” guitar cable) can result in a ground loop.

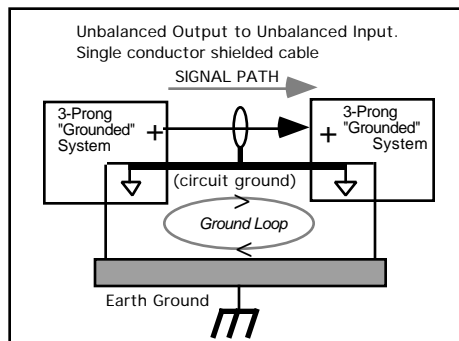

FIG. 1

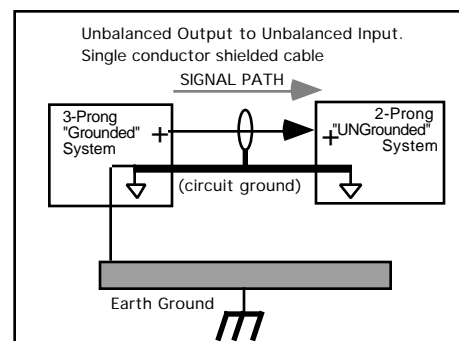

FIG. 2

Fig. 1 depicts a system interconnection where a ground loop can exist. Fig. 2 depicts a system interconnection where a ground loop does NOT exist. When interconnecting 3-prong grounded systems, you can use signal isolation transformers to prevent ground loops. This coupling transformer effectively isolates two interconnected system signal grounds, while still allowing the signal to pass through.

AC Line Conditioning

As with any computer device, the KT is sensitive to sharp peaks and drops in the AC line voltage. Lightning strikes, power drops, or sudden and erratic surges in the AC line voltage can scramble the internal memory and, in some cases, damage the unit’s hardware. Here are a few suggestions to help guard against such occurrences:

- **A Surge/Spike Suppressor.** The cheaper of the options, a surge/spike suppressor absorbs surges and protects your gear from all but the most severe over-voltage conditions. You can get multi-outlet power strips with built-in surge/spike suppressors for little more than the cost of unprotected power strips, so using one is a good investment for all your electronic equipment.
- **A Line Conditioner.** This is the best, but by far the more expensive way to protect your gear. Besides protecting against surges and spikes, a line conditioner guards the equipment against excessively high or low line voltages. If you use the KT in lots of different locations with varying or unknown AC line conditions, you might consider investing in a line conditioner.

Guidelines for using the KT

Temperature Guidelines

The inner workings of the KT contain a substantial amount of computerized and electronic circuitry that can be susceptible to damage when exposed to extreme temperature changes. When the KT is brought inside after sitting in a cold climate (i.e. the back seat of your car), condensation builds up on the internal circuitry in much the same way a pair of glasses fogs up when you come inside on a cold day. If the unit is powered up as this condensation occurs, components can short out or be damaged. Excessively high temperatures also pose a threat to the unit, stressing both the internal circuits as well as the case. With this in mind, it is highly advisable to follow these precautions when storing and setting up your KT:

- Avoid leaving the KT in temperatures of less than 50 degrees Fahrenheit or more than 100 degrees Fahrenheit.
- When bringing the KT indoors after travel, allow the unit at least twenty minutes to reach room temperature before powering up. In the case of excessive outdoor temperatures (below 50 degrees Fahrenheit or above 100 degrees Fahrenheit), allow an hour or more before power up.
- Avoid leaving the KT inside a vehicle exposed to direct sunlight.

Amplification Guidelines

Connect the **Audio Outputs** of the KT to the line level inputs of a mixer, instrument amplifier, stereo, or any other sound system, using 1/4 inch audio cables. If your system is stereo, connect the **Left and Right Audio Outputs** to two channels of your mixer, stereo, etc. and pan them hard left and hard right respectively. If it's mono, use either of the **Audio Output** jacks, but make sure nothing is plugged into the other output. For listening through headphones, plug the headphones into the **Phones** jack located on the front of the unit near the Pitch and Modulation wheels.

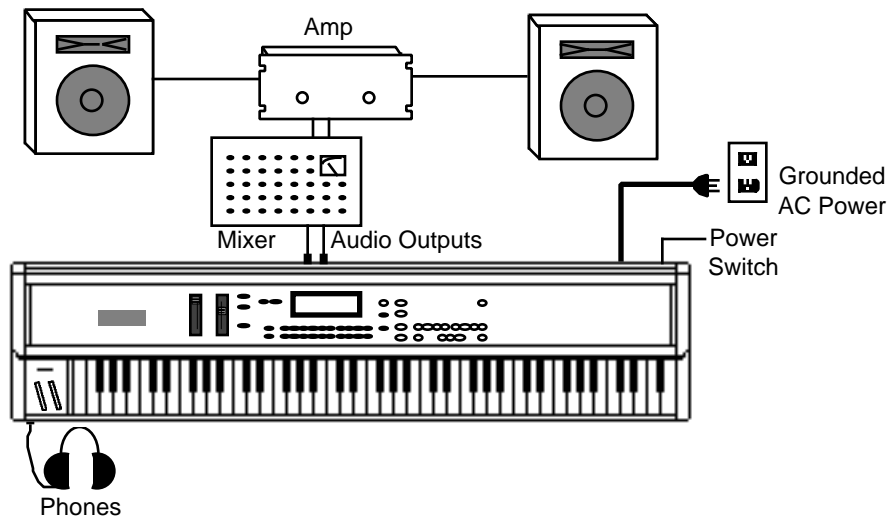

It is a good idea to make sure your audio system is turned off (or down) when making connections, to avoid damaging speakers or other components.

Be Careful!

The KT outputs are line-level, and are intended to be connected only to line-level inputs, such as those on a mixer, stereo pre-amp, keyboard amp, etc. Connecting the KT audio outputs to a mic-level input, such as a guitar amp or the microphone jacks on a tape deck, is not recommended, and might result in damage to the device input.

Move the **Volume Slider** all the way up. As with any digital musical instrument, the KT will give the best results if you keep the **Volume Slider** full on, and use the volume control on your mixer or amp to adjust its level.

Switch the audio system on and adjust the amplifier volume for normal listening levels. If you hear no sound while playing the keyboard, switch the audio system off and check your connections.

Amplifying Your KT Through a Home Stereo System

If you are thinking about amplifying your KT through your home stereo, please be careful. A home stereo is great for playing CDs, albums or tapes — the dynamic range of these media is limited, and your speakers aren't usually subjected to extreme volume changes and frequency transients. While the dynamic range of CDs is significantly greater than LPs or tapes, the output of a CD player is still conservative compared to the uncompressed, unlimited line-level output of a pro-level keyboard. Running your KT, or any pro-level keyboard through a home stereo at high volume levels can damage your speakers, not to mention the impedance mismatch this can create. If your only means of amplification is your home stereo, then try to keep your levels on the conservative side.

Powering Up Your KT In a MIDI Configuration

Just as you would power up the individual components before turning on the amplifier in your home stereo system, you should first turn on the MIDI data transmitting source (keyboards, modules, etc.) before you power up the receiving MIDI source. This will prevent any unwanted MIDI information from being “spit” out of the transmitting source during power up, which could confuse the MIDI receivers, thereby disabling them. If this should occur, turn off the receiving module, and then turn it back on.

Battery Replacement Guidelines

The reason that the KT “remembers” sounds, sequences and other parameters, even when the power is off, is that all of its internal RAM is “battery-backed-up.” The battery that keeps the KT memory intact is located inside the KT, and when it becomes discharged the battery must be replaced by an Authorized ENSONIQ Repair Station.

The battery that came in your KT is good for up to five years. You will know when it needs replacing, because the KT will tell you so. One day you will switch the power on, and instead of its usual wake-up message, the display will show:

Main Battery Low See Manual!

Press any button to commence normal operation. Then, make sure that all sounds and sequences/presets are saved to a storage card (or through SysEx), and take the KT to an Authorized ENSONIQ Repair Station as soon as possible to have the battery replaced.

Card Battery Replacement

When the PCMCIA card battery is low, the KT will display the following message:

Card Battery Low See Manual!

This message is referring to the battery in the card, not the battery in the KT. It is telling you that the battery in the memory card is low and it needs to be replaced. Card batteries are easy to change, and do not have to be replaced by an Authorized ENSONIQ Repair Station. See *Section 13 — Storage* for how to change the card battery.

Reinitializing the KT

The great power and flexibility of the KT lies in the fact that it is really a computer — a computer disguised as a keyboard instrument, but a computer nonetheless. The software that operates the KT is very sophisticated. If you have ever used a computer, you should be familiar with the need to reboot your system occasionally when you get an error message, etc. Reinitializing the KT is the equivalent of rebooting your computer.

There are a number of things that can happen to the KT (or any computer system) that might scramble the system software — voltage surges, power failures, static electricity, etc. As with any computer, very infrequently some unforeseen event or combination of events can cause the software to become confused with strange and unpredictable results. Sometimes computers that appear to be broken have no hardware problem, just corrupted data in the internal RAM (Random Access Memory). Sometimes simply turning the KT power off and then on again will cure the problem. If that doesn't work, perhaps what is needed is to reinitialize the unit.

If your KT begins to behave in peculiar ways — if the display shows words or lines that shouldn't be there, if you start getting Unexpected Event messages, if the sequencer and edit functions start doing unpredictable things, try reinitializing the KT before you seek factory service.

☞ **Warning:** When you reinitialize your KT all your current internal sounds and sequences/presets will be lost (the 80 factory shipped i:INT sounds and the Tutorial Sequence are automatically restored back into the internal memory after reinitializing). Therefore good backup habits should be an important part of your routine. Save any important data to a storage card or MIDI Sys-Ex before reinitializing the KT.

To Reinitialize the KT

1. Press the {EDIT_SEQ/PRESET} button. Its LED will light, letting you know the KT is now in Edit Sequence/Preset mode.
2. While holding down the upper {9} button, press the lower {9} button.
3. The display shows:

Reinitialize sound & seq RAM?

4. Press the {YES} button (the {ENTER} button acts as a “Yes” button to respond to questions on the display, and the {} button acts as “No”).

If reinitializing your KT does not correct the problem, contact an Authorized ENSONIQ Repair Station. To find the nearest Authorized ENSONIQ Repair Station, call 1-800-553-5151.

How to Use this Manual

The KT accesses parameters and commands through *groups of pages*. Each page may have one or more editable parameters. Pages inside a command are referred to as *sub-pages*. Each page has its own page location, a two-digit number that indicates its location. The first digit refers to the top {0} to {9} buttons, the second digit refers to the bottom {0} to {9} buttons.

Page Locations

When describing parameters or commands in this manual, “Page Location headings” are used to show the location of the parameter and how to get there by “direct-dialing.” For example:

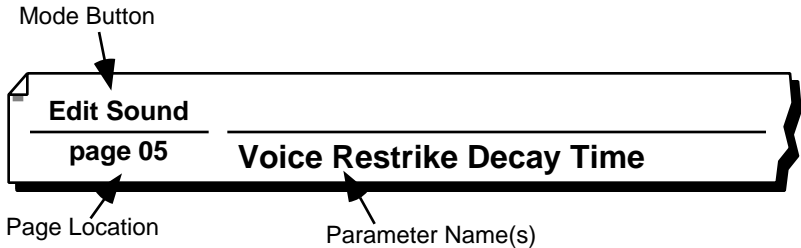

These page locations not only help you locate information easily, they also provide the following information about the parameter(s) being discussed:

- **Mode button** — The button name in the top left of the heading indicates the mode in which the parameter is located. In the above illustration, it is Edit Sound mode (press the {EDIT_SOUND} button to get there).
- **Page Location** — The two-digit number on the bottom left indicates the location of the parameter(s). In this example, it is “page 05,” found by pressing the {0} button from the top {0} to {9} buttons, then pressing the {5} button from the bottom {0} to {9} buttons.
- **Parameter Name(s)** — This tells you the name or names of the parameters as they are shown in the display. When the display has more than one parameter, they are divided (in the manual) by a slash (/). Note that if a parameter does not have a name in the display, one will be written in the manual heading that best describes the displayed parameter.

Single Digit Page Locations

In Edit Track and System•MIDI modes, only the bottom {0} to {9} buttons are used to direct-dial the page location, as shown below:

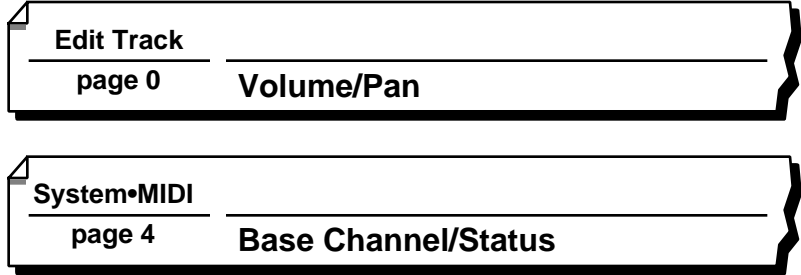

Button Names

Throughout this manual, when we refer to an actual button, it will appear as a button in the text. For example, if the text read something like “press the Edit Sound button,” it would appear as “press the {EDIT_SOUND} button.” This will help you to quickly skim through familiar sections of the manual as you verify actual button presses.

Color-Coding on the Front Panel

The KT uses a color-coding scheme to help clarify the functions of the buttons. In general, functions relating to sounds are labeled in red. Functions relating to sequences, presets, or songs are labeled in blue. General system functions are labeled in white. The two rows of {0} to {9} buttons serve different functions, depending upon what mode you are currently working in.

You’ll notice that the rows of text printed above and below the {0} to {9} buttons are labeled in red and blue. These indicate which pages of parameters will be selected by the {0} to {9} buttons.

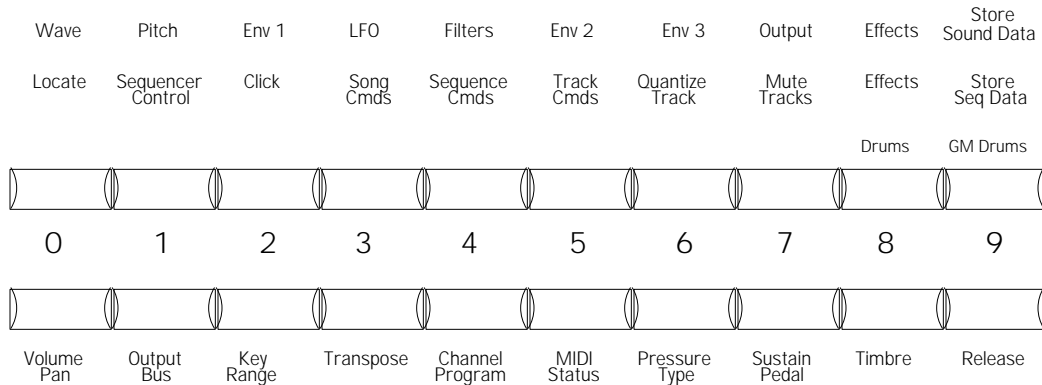

When in:	Then:
Edit Sound mode (indicated by the {EDIT_SOUND} LED being lit)	the top row of page names written in red will apply.
Edit Sequence/Presets mode (indicated by the {EDIT_SEQ/PRESET} LED being lit)	the middle row of page names written in blue will apply.
Edit Track mode (indicated by the {EDIT_TRACK} LED being lit)	the bottom row of page names written in blue (found under the lower {0} to {9} buttons) will apply.

These relationships are also indicated on the front panel by the lines that lead from the right of each row of text to their associated mode buttons.

Using the Color-Coded Text

Let’s say that you want to use the color-coded text to help you locate the Click pages for editing a sequence.

1. Press the {EDIT_SEQ/PRESET} button (its LED is on).
2. Look at the front panel and find the blue word Click (remember blue is for sequences). It’s above the {2} button.
3. Press the upper {2} button. This takes you to the pages relating to the Click (metronome).
4. Press any of the lower {0} to {2} buttons to view the available Click pages. Pretty easy, huh?

Available Options for Your KT

These optional accessories are available from your Authorized ENSONIQ Dealer:

- **SW-10 Dual Damper Foot Switch** — This two pedal piano-type foot switch can be used for sustain, sostenuto, or starting and stopping the sequencer.
- **CVP-1 Pedal** — A *Control Voltage Foot Pedal* that can either be assigned as a real time modulator within the voice architecture and effects of the KT or be used as a volume pedal.
- **MS-1 Music Stand** — A detachable music stand designed to hold everything from single page sheet music to large songbooks.
- **MC-512 RAM Cards** — These standard PCMCIA cards are used for storing the sounds and sequences you create or edit. The MC-512 also acts as a sequencer expander, with over 100,000 notes of sequencer memory, and with direct memory access, can be used for creating very long, large sequence/songs. Sounds and sequences can be saved to the MC-512 in the same manner as saving data to internal memory.
- **KTC Series ROM Cards** — Contains 160 factory-programmed sounds and accompanying sequencer data. Unlike the MC-512, the sounds on KTC cards are stored permanently and cannot be replaced.
- **EVS-6** — This instructional video walks you through the many features of the KT with step-by-step instructions and training methods used in the award-winning ENSONIQ school.

Where to Find More Help

Whether you're an aspiring programmer looking for additional information about basic synthesizer techniques and MIDI theory, or a professional sound designer working with advanced applications, you may want more detailed information that is beyond the scope of this manual. The following books can help enhance your understanding of synthesis, MIDI, and related topics. These, in addition to the numerous monthly magazines, provide a wealth of information. While we don't endorse any one of these publications, we offer this partial list as a resource for you to draw on.

The Mix Bookshelf

For prices and more information call: 1-800-233-9604

MIDI

MIDI FOR MUSICIANS, Craig Anderton

THE MIDI MANUAL, David Huber

MIDI FOR THE PROFESSIONAL, Lehrman & Tully

THE NEXT MIDI BOOK, Rychner & Walker

HOW MIDI WORKS, Dan Walker

MIDI, THE INS, OUTS AND THRUS, Jeff Rona

SYNTHESIZERS

GUITAR SYNTH & MIDI, Guitar Player Magazine

SECRETS OF ANALOG AND DIGITAL SYNTHESIS, Steve De Furia

SYNTHESIZER PERFORMANCE & REAL TIME TECHNIQUES, Jeff Pressing

SYNTHESIZER BASICS, Dean Friedman

MUSIC & TECHNOLOGY, H.P. Newquist

A SYNTHESIST'S GUIDE TO ACOUSTIC INSTRUMENTS, Howard Massey

Alfred Publishing Company

For prices and more information call 1-818-891-5999

MIDI

ADVANCED MIDI APPLICATIONS, GPI

BASIC MIDI APPLICATIONS, GPI

WHAT IS MIDI?, GPI

SYNTHESIZERS

BEGINNING SYNTHESIZER, GPI

PLAYING SYNTHESIZERS, GPI

SYNTHESIZER PROGRAMMING, GPI

Hal Leonard Publishing

For prices and more information call 1-414-774-3630

MIND OVER MIDI, GPI

SYNTHESIZER TECHNIQUE (REVISED), GPI

Monthly Magazines

The following magazines offer many specific articles and columns that can provide a plethora of useful information.

THE TRANSONIQ HACKER

For prices and more information about this independent news magazine for ENSONIQ Users, call 1-503-227-6848

KEYBOARD

For subscription rates and more information call 1-800-289-9919

ELECTRONIC MUSICIAN

For subscription rates and more information call 1-800-888-5139

HOME & STUDIO RECORDING

For subscription rates and more information call 1-818-407-0744

MIX

For subscription rates and more information call 1-800-888-5139

EQ

For subscription rates and more information call 1-212-213-3444

Section 1 — Controls & Basic Functions

This section contains an introduction to the KT's many controls and rear panel connections; a conceptual overview of the system; a guide to selecting sounds, presets, and sequences; and a discussion of editing various types of parameters.

Rear Panel Connections

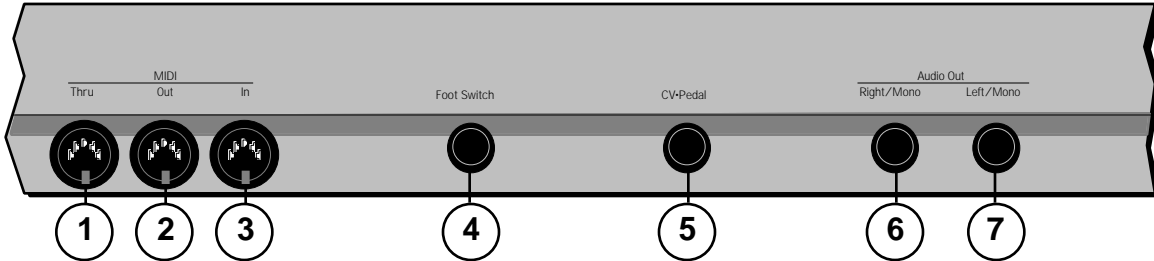

1. MIDI Thru

“Passes on” all MIDI (Musical Instrument Digital Interface) information received by the KT to other devices. Information generated by the KT itself does not go to this jack — the Thru jack merely echoes what comes into the MIDI In jack.

2. MIDI Out

Sends out MIDI information generated by the KT keyboard and/or sequencer to other instruments and computers.

3. MIDI In

This jack receives MIDI information from other MIDI instruments or computers.

4. Foot Switch

This jack allows you to connect either a single (mono) or a dual (stereo) foot switch:

- If you plug the ENSONIQ Model SW-6 Single Damper Foot Switch (which came with your unit) into this jack, it will perform the function assigned to the FtswR parameter (found on {SYSTEM"MIDI} page {2}).
- Or you can connect the optional ENSONIQ Model SW-10 Dual Foot Switch here. The SW-10 is a dual (piano-type) foot switch with two separate pedals. When the SW-10 is connected, the left pedal will perform the function assigned to FtswL and the right pedal will perform the function assigned to FtswR (both are found on {SYSTEM"MIDI} page {2}).

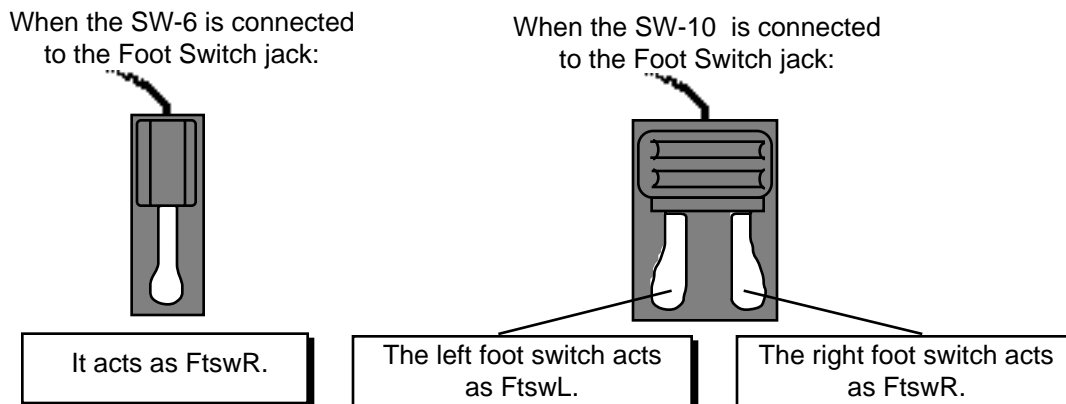

The FtswL and FtswR parameters on System•MIDI page 2 allow you to reassign the foot switches to a variety of functions, including sostenuto and stopping/continuing the sequencer. See *Section 2 — System•MIDI Parameters* for more information.

Note: If you are using a single foot switch (SW-2 or SW-6) in the Foot Switch jack, the FtswL parameter on System•MIDI page 2 should always be set to UNUSED. This will prevent note drones. Remember that the **Foot Switch** jack is optimized for use with a stereo Foot Switch (SW-10). When a single foot switch is connected, it behaves like the right foot switch (FtswR).

5. CV•Pedal

This jack is for connecting an optional ENSONIQ Model CVP-1 Control Voltage Foot Pedal, which is assignable as a modulator to various parameters within the KT. The pedal gives you a handy alternative modulation source when, for example, you would want to use the mod wheel but both hands are busy.

A CV pedal plugged into this jack can also act a volume pedal, controlling the volume of the currently selected sound(s). The CV-Pedal parameter on {SYSTEM"MIDI} page {3} determines whether the CV pedal will act as a modulator or as a volume pedal.

Pedal/CV Specs: 3-conductor (Tip= control voltage input, Ring=+5 Volts supplied through a 510 ohm resistor, Sleeve= ground). 36 KOhm input impedance, DC coupled. Input voltage range=0 to 3 volts DC. Scan rate=32mS (maximum recommended modulation input= 15 Hz). For use with an external control voltage, use a 2-conductor cable with the voltage on the tip and the sleeve grounded.

ENSONIQ
CVP-1
Control Voltage Foot Pedal

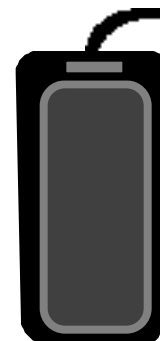

6. Right /Mono Output

To operate the KT in stereo, connect this output to a channel of your mixer and pan that channel right. Note that either of the audio outputs can be used as a mono output. If you want to use this jack to listen to the outputs in mono, make sure that nothing is connected to the **Left/Mono** audio output jack.

7. Left/Mono Output

When operating the KT in stereo, connect this output to a channel of your mixer and pan the channel left. To use this jack to listen to the outputs in mono, make sure that nothing is connected to the **Right/Mono** audio output jack.

The Front Panel Controls

The KT's front panel is designed to enable you to get around the instrument quickly and easily, whether selecting and playing sounds, or recording and playing back sequences.

To do this, the KT is always in one of the following modes:

Select Sound mode	Edit Track mode
Edit Sound mode	Replace Track Sound mode
Select Sequence/Preset mode	System•MIDI mode
Edit Sequence/Preset mode	General MIDI mode

You select these modes by pressing the appropriate button. Note that these buttons have LEDs to help you identify which mode you are in. Once you have activated a KT mode, you can use the upper and lower numbered buttons ({0} to {9}) to move around inside the selected mode.

Color-Coding Scheme

The KT uses a color-coding scheme to help clarify the functions of the {0} to {9} buttons. In general, functions relating to sounds are labeled in red. Functions relating to the sequencer are labeled in blue. General system functions are labeled in white. The two rows of {0} to {9} buttons serve different functions, depending upon what mode you are currently working in.

You'll notice that the rows of text printed above and below the {0} to {9} buttons are labeled in red and blue. These indicate which pages of parameters will be selected by the {0} to {9} buttons. When in Edit Sound mode (indicated by the {EDIT_SOUND} LED being lit), the top row of page names written in red will apply. The middle row of page names written in blue will apply in Edit Sequence/Preset mode (indicated by the {EDIT_SEQ/PRESET} LED being lit). The bottom row of page names written in blue (found under the lower {0} to {9} buttons) will apply when in Edit Track mode (indicated by the {EDIT_TRACK} LED being lit).

The **Data Entry Controls** are primarily used to select and modify different parameters — sounds, parameters, MIDI Control functions, etc. — all depending on which front panel button you press.

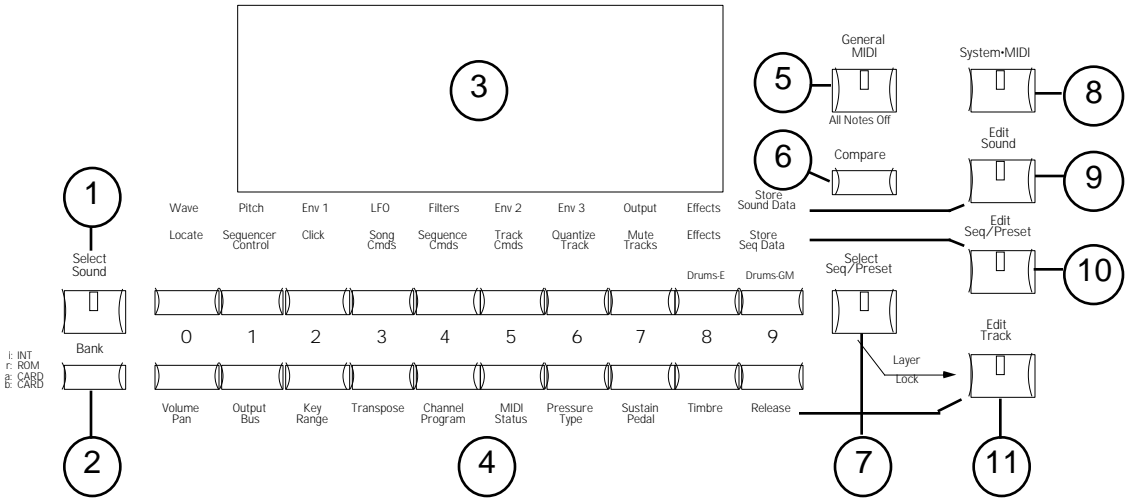

1. Select Sound Button

Pressing the {SELECT_SOUND} button lights its LED and places the KT in Select Sound mode. Whenever you want to change a sound, this mode must be activated. After pressing {SELECT_SOUND}, use the upper and lower {0} to {9} buttons to select any of the available sounds, or use the {VALUE} buttons.

2. Bank Button

The {BANK} button changes banks in Select Sound, Select Sequence, and Replace Track Sound modes. Successive presses of the {BANK} button cycle through the available banks. The different banks are listed on the front panel (by the {BANK} button). There are four banks of 80 Sounds each available in the KT: i:INT internal RAM, r:ROM (uneditable and permanent), a:CARD and b:CARD. A fifth ROM bank containing the 128 General MIDI Sounds is only accessible in General MIDI mode. An additional 20 Drum Sounds are permanently stored in r:DRUM ROM, and are accessible from any of the four banks. Note that when r:DRUM ROM sounds are selected, direct-dialing will not function.

There are also four Banks of 70 Sequences/Presets and 30 Songs, each available in the KT (i:INT, r:ROM, a:CARD and b:CARD).

Direct-Dialing Banks

While pressing and holding {BANK}, pressing one of the lower {0} to {3} buttons will direct-dial a bank:

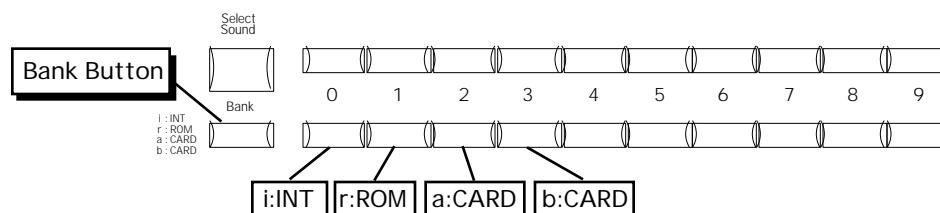

While pressing and holding the {BANK} button, pressing:	Will direct dial:
The lower {0} button	i:INT (the Internal RAM bank)
The lower {1} button	r:ROM (the ROM bank)
The lower {2} button	a:CARD (the Card A bank)
The lower {3} button	b:CARD (the Card B bank)

When pressed in Select Sound and Replace Track Sound modes, the {BANK} button transmits MIDI Bank Select messages corresponding to the Sound bank you selected.

When saving a Sound to a new location, the {BANK} button can be used to change destination banks (i:INT, a:CARD, or b:CARD). Note that sounds can't be saved to r:ROM (Read Only Memory) — it is uneditable and permanent.

3. Display

The 32-character LCD display makes it possible to display information in pages. Each time you press one of the front panel buttons, you are in effect “turning to” that function’s page. Once you have turned to the page you want, the display shows you which parameters are controlled from that page. Try pressing a few of the buttons — {SYSTEM”MIDI}, {EDIT_SOUND}, {EDIT_TRACK}, or {SELECT_SOUND}, for example, and watch the display. Notice that for each button you press, the display changes to show you information relating to that function. Each of these different display configurations is called a *Page*.

4. 0 to 9 Buttons

The upper and lower {0} to {9} buttons (beneath the display) are used to select pages of parameters, commands, sounds, or sequences/presets. The function of the {0} to {9} buttons is determined by which mode the KT is in.

When a page with multiple parameters is displayed, successive presses on the lower {0} to {9} button will move between each of those parameters. The lower {0} to {9} buttons also have a special function when held: after about one second the first parameter on the page will become selected.

You'll notice that the rows of text printed above and below the {0} to {9} buttons are labeled in red and blue. These indicate which pages of parameters will be selected by the {0} to {9} buttons. When in Edit Sound mode (indicated by the {EDIT_SOUND} LED being lit), the top row of page names written in red will apply. The middle row of page names written in blue will apply in Edit Sequence/Presets mode (indicated by the {EDIT_SEQ/PRESET} LED being lit). The bottom row of page names written in blue (found under the lower {0} to {9} buttons) will apply when in Edit Track mode (indicated by the {EDIT_TRACK} LED being lit).

As you might expect, when in Select Sound or Select Sequence/Presets modes, the {0} to {9} buttons select pages of sounds or sequences/presets respectively.

Tip: There is another way to view the individual pages located within a group. After using one of the upper {0} to {9} buttons to call up a group of pages, successive presses on that upper {0} to {9} button will scroll through all the pages within that group. Also, the first page within a group of pages can be selected by holding the upper {0} to {9} button down for about one second.

5. General MIDI Button

The {GENERAL_MIDI} button is used to enter and exit General MIDI mode. Pressing the {GENERAL_MIDI} button will light its LED, and the KT will enter General MIDI mode. All buttons except the {CURSOR}, {VALUE}, {TRANSPOSE_KEYBOARD}, and {GENERAL_MIDI} buttons are disabled.

The {GENERAL_MIDI} button also functions as an “All Notes Off” button. Before entering General MIDI mode, the KT transmits the following MIDI initialization messages to prevent note and controller drones: All Notes Off, Reset Controllers, key-ups for all keys down, sustain and sostenuto pedal ups, and controller normalization. By pressing the {GENERAL_MIDI} button twice, it functions as a “MIDI Panic” button. For more information about General MIDI, see *Section 12 — The MIDI Connection*.

6. Compare Button

The {COMPARE} button is used to compare any edits you have made to a sound with the original version. As soon as you change any parameter in a sound, the {EDIT_SOUND} LED will flash. It will remain flashing until you select another sound or save (write) the newly edited sound into memory. This is a constant reminder that something in the sound has been changed.

To hear the original, unchanged sound, press the {COMPARE} button. The {EDIT_SOUND} LED will light solidly, and you will hear the original sound and see the current page with its original settings. Press {COMPARE} again to return to your edited sound. You can toggle back and forth between the original and the edited sound as often as you like.

7. Select Seq/Presets Button

Pressing {SELECT_SEQ/PRESET} lights its LED and places the KT in Select Sequence/Presets mode. After pressing the {SELECT_SEQ/PRESET} button, the {BANK} and upper and lower {0} to {9} buttons are used to select and play any available Preset, Sequence or Song. In this mode, multiple tracks can be selected and stacked by pressing and double-clicking the {SEQUENCER/PRESET_TRACK} buttons. For more details see *Section 8 — Understanding Presets*.

8. System•MIDI Button

Pressing {SYSTEM•MIDI} lights its LED and places the KT in System•MIDI mode. After pressing {SYSTEM•MIDI}, you can access all global System and MIDI parameters. Successive presses of the {SYSTEM•MIDI} button, or the {CURSOR} buttons allow you to cycle through all the System•MIDI parameters. The lower {0} to {9} buttons direct-dial all System•MIDI pages.

Press any mode or {SEQUENCER/PRESET_TRACK} button to exit System•MIDI mode. Pressing any of the upper {0} to {9} buttons returns the KT to the last selected operating mode (Edit Sound mode or Edit Sequence/Preset mode).

9. Edit Sound Button

Pressing the {EDIT_SOUND} button lights its LED and places the KT in Edit Sound mode. This is where all sound editing is done. From this mode you can choose waveforms, change envelopes, etc. Pressing the upper and lower {0} to {9} buttons takes you to the individual parameter pages within Edit Sound mode.

10. Edit Seq/Preset Button

Pressing {EDIT_SEQ/PRESET} lights its LED and places the KT in Edit Sequence/Preset mode. This mode is used for such tasks as editing sequence events, setting tempo and metronome click, etc. In Edit Sequence/Preset mode, the upper and lower {0} to {9} buttons are used to select the individual parameters or commands. Pressing a {SEQUENCER/PRESET_TRACK} button determines which Track will be edited (only one track is active at a time).

11. Edit Track Button

Pressing {EDIT_TRACK} lights its LED and provides convenient access to all Track parameters. The {EDIT_SEQ/PRESET} LED also lights, as a reminder that Edit Track is a subdivision of Edit Sequence/Preset mode. {SEQUENCER/PRESET_TRACK} buttons behave as they do in Edit Sequence/Preset mode (only one track is active at a time). Pressing a {SEQUENCER/PRESET_TRACK} button determines which Track's values are displayed. The {CURSOR} buttons, or successive presses of the {EDIT_TRACK} button, allow you to cycle through all the Edit Track parameters. The lower {0} to {9} buttons can also be used to “direct-dial” the Track performance parameters, as labeled in blue beneath the lower {0} to {9} buttons. Pressing any upper {0} to {9} button from Edit Track mode puts the KT into Edit Sequence/Preset mode.

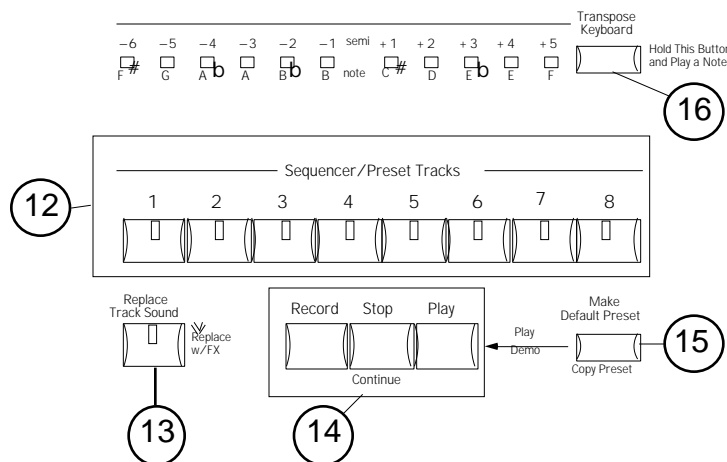

12. Sequencer/Preset Track Buttons

In Edit Sequence/Preset mode, the {SEQUENCER/PRESET_TRACK} buttons are used to select eight independent tracks. Each track can have a different sound and a unique set of performance parameters associated with it. By double-clicking (press two times quickly) a {SEQUENCER/PRESET_TRACK} button while another is selected, you can layer tracks. When sequences are linked together to create a song, these same buttons are used to create eight additional song tracks, for a total of sixteen sequencer tracks. Sequence tracks are always displayed as Trk 01-08; song tracks are always displayed as Trk 09-16.

13. Replace Track Sound Button

Pressing the {REPLACE_TRACK_SOUND} button lights its LED, and places the KT into Replace Track Sound mode. This mode allows sounds on the individual tracks of a preset/sequence or song to be assigned and changed. To replace a sound with its effect, double-click the {REPLACE_TRACK_SOUND} button (its LED will flash to indicate this special function). For more details, see *Section 8 — Understanding Presets*.

14. Transport Controls

The “Transport Controls” are used to start, stop, and continue the sequencer, and to put it into Record and Overdub modes. For more information, see *Section 10 — Understanding the Sequencer*.

15. Make Default Preset Button

In Sound mode, the {MAKE_DEFAULT_PRESET} button allows you to copy the current Sound, with its effect, into an empty preset location. It predefines Track parameter settings for each Track, creating a “default template.” This “template” serves as a standard starting place for MIDI Master Keyboard operation.

In Seq/Preset mode, pressing {MAKE_DEFAULT_PRESET} will copy the current Track parameter settings and allow you to save the copy to any undefined preset memory location.

The Make Default Preset function will always work only in the current Seq/Preset mode bank:

- When the current Seq/Preset mode bank is i:INT, pressing the {MAKE_DEFAULT_PRESET} button will define a new i:INT preset location (if one is available). If all 70 locations have been defined, the “SORRY! No free Seq Location” message will be displayed.
- When the current Seq/Preset mode bank is a:CARD or b:CARD, pressing {MAKE_DEFAULT_PRESET} will define a new preset location in the current CARD bank (if one is available). If all 70 locations have been defined, the “SORRY! No free Seq Location” message will be displayed.
- When the current Seq/Preset mode bank is r:ROM, pressing {MAKE_DEFAULT_PRESET} will change the Seq/Preset mode bank to i:INT, and then will define a new i:INT preset location (if one is available). If all 70 locations have been defined, the “SORRY! No free Seq Location” message will be displayed.

Holding down the {MAKE_DEFAULT_PRESET} button and pressing the {PLAY} button will select r:ROM Song 70 and will start playback of the Demo Song.

16. Transpose Keyboard Button

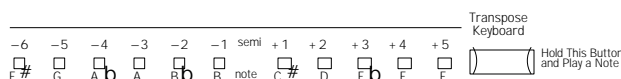

The {TRANPOSE_KEYBOARD} button (with its associated LEDs) is a global control that affects what pitch will be heard when the keyboard is played, and which musical key any notes played will be transposed to relative to the key of C. It applies to live playing on the keyboard in all system modes, and behaves as if you had shifted your hands up or down the keyboard by the Transposition amount.

Live keyboard playing can be transposed up by a maximum of 5 semitones, and down by a maximum of 6 semitones. The transpose amount is calculated relative to any C on the keyboard.

To transpose the keyboard:

1. Press and hold the {TRANPOSE_KEYBOARD} button.
2. Press a key on the keyboard that you would like to transpose to. For this example, press any E. Notice the LED above E lights.
3. Release the {TRANPOSE_KEYBOARD} button. The LED above E remains lit, and the C key now plays the E note (remember, the Transpose Keyboard function is relative to C).

To disable the Transpose Keyboard function (when any Transpose Keyboard LED is lit):

1. Press and release the {TRANPOSE_KEYBOARD} button without pressing any keys. The lit Transpose Keyboard LED will be turned off, and you will be returned to a normal, untransposed state. The previous transposed amount is remembered.
- Pressing {TRANPOSE_KEYBOARD} again will retranspose the keyboard to the last value.

More About the Transpose Keyboard Function

- Only one Transpose Keyboard LED can be on at one time.
- The currently lit Transpose Keyboard LED indicates the transposition amount.
- When all Transpose Keyboard LEDs are off, transposition is disabled.
- After power-on, the transposition amount defaults to C (no transposition).
- If a C is played while the {TRANSCOPE_KEYBOARD} button is held down, the currently lit LED will turn off and the transposition amount will be set to C.
- While the {TRANSCOPE_KEYBOARD} button is still held down, you may continue to play notes to set the transposition to other values. Releasing the {TRANSCOPE_KEYBOARD} button will leave any currently lit LED on.
- Notes played while the {TRANSCOPE_KEYBOARD} button is held down will be heard at their untransposed pitch (to help you find the pitch you want to transpose to).
- Pressing and holding the {TRANSCOPE_KEYBOARD} button, and pressing the {VALUE} or {CURSOR} buttons, will increment or decrement the transposition amount from the previously set amount. The value will wrap; i.e. if the transposition is set to F, pressing the {TRANSCOPE_KEYBOARD} button and then the {[] } button will change the transposition to the lower F#.
- If the LEDs are off, and no transposition amount has previously been set (such as after power on), pressing and releasing the {TRANSCOPE_KEYBOARD} button will shut off all playing voices. The LEDs will remain off.
- Whenever the {TRANSCOPE_KEYBOARD} button is released, all notes currently held on the KT keyboard, or sustained by the local sustain or sostenuto pedal, will be released.

When one of the Transposition LEDs is on:

- Playing on the KT keyboard — into the local sounds, into the sequencer, and out to the MIDI Out jack will be transposed by the amount set.
- Notes output from sequencer playback — using local sounds or to the MIDI Out jack will not be transposed.
- Voice key zones, Drum Sound key ranges and Track key ranges for playing on the KT keyboard will be transposed by the amount set.
- Notes received from incoming MIDI will not be transposed.

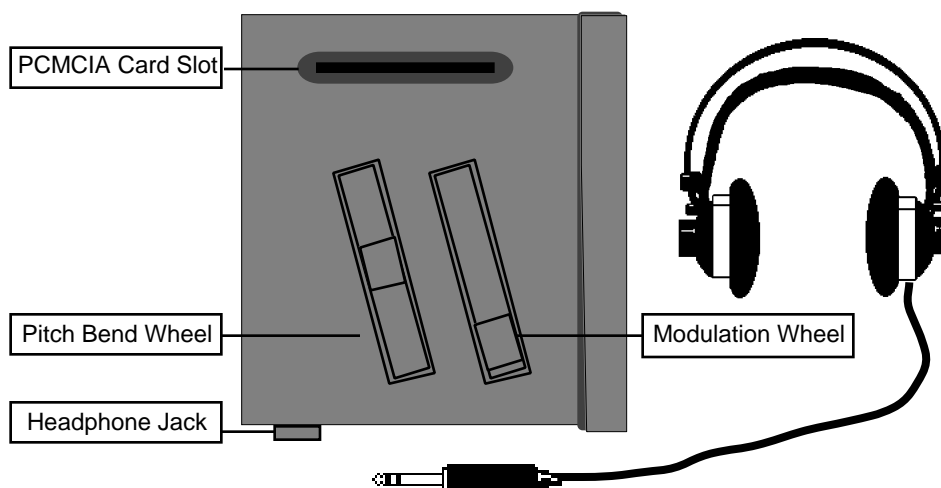

PCMCIA Card Slot

This slot accepts industry standard PCMCIA RAM or ROM cards, which can be used for storing and accessing sounds and sequencer data. Blank cards are available from most computer stores, or from ENSONIQ (Model #MC-512 RAM cards).

The KT can use PCMCIA RAM cards ranging in size from 512 KBytes to 2 MegaBytes, but the KT will always format all cards to the same size (512 KBytes). They are always formatted to hold up to two banks of 80 Sounds (a:CARD and b:CARD), and two banks of 100 Presets/Seqs/Songs (a:CARD and b:CARD). Sounds and sequences/songs can be played directly from cards.

For more information about memory, storage and PCMCIA cards, see *Section 13 — Storage*.

PCMCIA Memory Cards

Before you can access sounds and sequences from a card, you must first insert an ENSONIQ KTC series ROM card, an MC-512 RAM card, or any other KT formatted PCMCIA card into the card slot, as shown, with the label facing toward you. Take care to insert the card straight into the slot in a continuous fashion. Cards can only go in one way.

Cards can be inserted or removed at any time (except while you're writing sounds, or playing/recording sequences from/to them), even when the power is on, without doing any harm to the KT or the card. For more information regarding cards, see *Section 13 — Storage*.

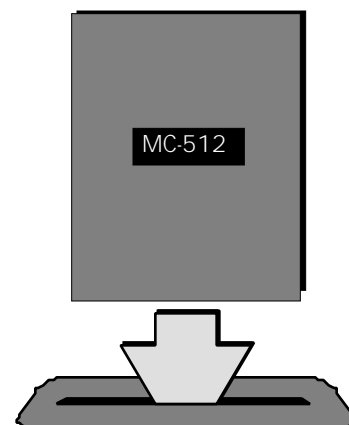

Headphones

To listen to the KT in stereo through headphones, plug the phones into this jack. Headphone volume is controlled by the **Volume Slider** on the front panel. Note that plugging headphones into this jack does not automatically turn off the audio in the left and right audio outputs.

⚠ **Warning:** The headphone output volume is optimized for mid to high impedance headphones (50 - 600 ohms). If you use low impedance headphones (8 ohm "Walkman™" style), be sure to lower the **Volume Slider**, as the high output volume levels could damage your hearing.

Performance Controllers

The KT features some real time performance controllers that are used to modify sounds as you play for maximum expressiveness. Two of the most important controllers are located to the left of the keyboard:

Pitch Bend Wheel

This wheel bends the pitch of a note up or down. The wheel is normally centered, where it has no effect on the pitch — moving the wheel up or down will bend the pitch by the amount specified in the Bnd parameter found on {SYSTEM" MIDI} page {0}.

Modulation (Mod) Wheel

Perhaps the most common use of the Mod Wheel is to add vibrato, but it can also be assigned as a modulator anywhere within the KT voice architecture to alter the pitch, timbre, volume, effect and a great many other aspects of the sound.

Pressure (After-touch)

Another important controller is *Pressure*. Pressure (often called after-touch) is a modulator that allows you to change the sound in various ways by pressing down harder on a key or keys after the initial keystroke. The KT keyboard is capable of generating Channel Pressure and can receive Poly-Key™ Pressure via incoming MIDI.

Like the Mod Wheel or CV Pedal, pressure is a modulator, and can be chosen wherever a modulator is selected in the KT. Pressure can be assigned to alter the pitch or volume of voices, the filter cutoff frequency, LFO depth, pan location, and a wide variety of effect parameters.

There are two types of Pressure:

- Channel Pressure, also called Mono pressure, affects all notes that are playing when you exert pressure on any of the keys. For example, if you play a three-note chord, pressing down harder on any of the three notes of the chord will modulate *all three notes*. This type of pressure is the more common of the two types.
- Poly-Key Pressure, also referred to as polyphonic pressure, affects each key independently. For example, if you play a three-note chord, pressing down harder on any of the three notes of the chord will modulate *only that note*. The other two notes will remain unaffected. Although the KT keyboard will not generate Poly-Key pressure, it will receive it via incoming MIDI.

Each preset or sequencer track can be programmed to receive Poly-Key pressure, channel pressure or none at all. If you wish to change the pressure type for a given track, you can do so on Edit Track page 6 (press {EDIT_TRACK}, then the lower {6} button).

Note that pressure generates a tremendous amount of data, and will consume sequencer memory much faster than other types of events, such as notes and program changes. You should turn pressure off when sequencing instruments that do not respond to pressure, such as piano and drum sounds.

Selecting Sounds

To select a KT sound:

- Press {SELECT_SOUND}. This places the KT in Select Sound mode and the {SELECT_SOUND} LED will light. Once in Select Sound mode, it is not necessary to press the {SELECT_SOUND} button again to select a new sound.

When the {SELECT_SOUND} LED is on, the upper and lower {0} to {9} buttons are used to call up the sounds in memory, one at a time, allowing you to select the one you want to play.

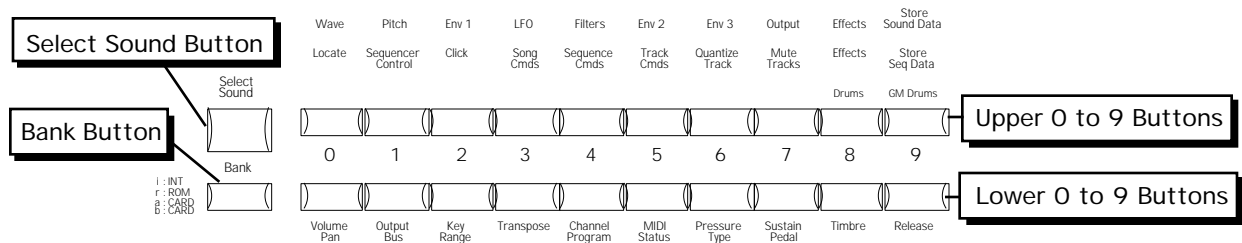

- Press the upper {0} button, then the lower {0} button. You have just selected Sound #00.
- Press the upper {6} button, then the lower {5} button. You have just selected Sound #65. Try selecting and playing a few different sounds.

Tip: You can also use the {VALUE} buttons to scroll through sounds. The {VALUE} buttons will scroll through all sounds within the current bank (for example, the i:INT Internal RAM sounds), and then will continue scrolling up through the r:DRUM ROM sounds.

Selecting r:DRUM ROM Sounds

The r:DRUM ROM Sounds can be selected just as you would select Standard Sounds.

To select a r:DRUM Sound:

1. Press {SELECT_SOUND}.
2. Press the upper {8} button to select drum sounds that use the ENSONIQ drum map.
3. Press any of the lower {0} to {9} buttons to select between the ten ROM drum sounds that use the ENSONIQ drum map.
4. Press the upper {9} button to select Drum sounds that follow the General MIDI Drum map.
5. Press any of the lower {0} to {9} buttons to select between the ten ROM drum sounds that follow the General MIDI drum map.

Sound Memory Configuration

Each KT sound is a complex structure consisting of up to three voices per key, and a programmable effects setup. The KT can give you access to up to 468 different sounds from which to choose at any time:

- **i:INT** — 80 sounds are stored in the KT Internal RAM Memory (Random Access Memory). The i:INT sounds can be either Standard sounds or Drum sounds.
- **r:ROM** — Another 80 sounds are permanently stored in ROM (Read Only Memory). Like the Internal (INT) sounds, the ROM sounds are contained within the KT; but unlike the Internal (INT) sounds, they cannot be modified or replaced.
- **a:CARD** and **b:CARD** — 160 additional sounds can be stored in a PCMCIA card (80 sounds in group A, and 80 sounds in group B) which is plugged into the card slot. As with the Internal (i:INT) bank, sounds stored in the card can be Standard or Drum sounds.
- **r:DRUM** — Sound locations 80 through 99 each contain a Drum sound. These 20 Drum sounds are available whether you're currently in the i:INT, r:ROM, or card (a:CARD or b:CARD) banks. The r:DRUM sounds are permanently stored in ROM memory and cannot be modified or replaced.
- **General MIDI Sounds** — There are 128 “hidden” General MIDI sounds that can be accessed by pressing the {GENERAL_MIDI} button.

Choosing Internal, ROM, and Card Sounds

In Select Sound mode, the display shows the bank and page location, and the name of the sound:

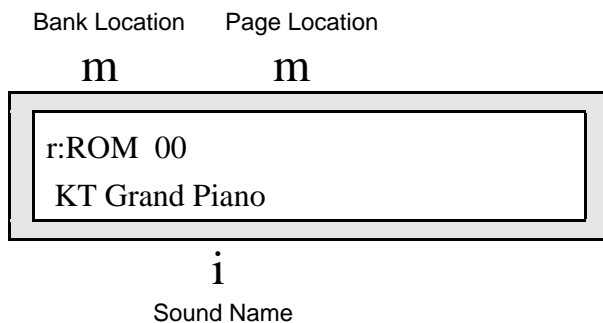

There are two methods that can be used to choose between the four banks:

- The {BANK} button — Repeatedly pressing the {BANK} button will step through the various banks.
- Direct-Dialing — You can reach any of the banks directly by pressing the {BANK} button, and while continuing to hold the {BANK} button down, press one of the lower {0} to {3} buttons.

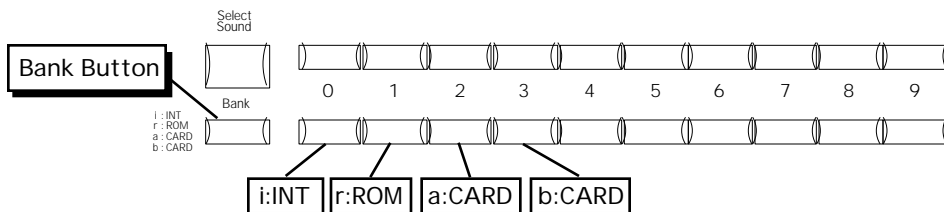

While pressing and holding the {BANK} button, pressing:	Will direct dial:
The lower {0} button	i: INT (the Internal RAM bank)
The lower {1} button	r: ROM (the ROM bank)
The lower {2} button	a: CARD (the Card A bank)
The lower {3} button	b: CARD (the Card B bank)

The lower {0} to {3} buttons are used to choose between i:INT, r:ROM, a:CARD and b:CARD sounds. Note that if there is no card installed, or there is no sound data on the card, the a:CARD and b:CARD banks will not be recognized.

The current Sounds bank and Seq/Preset bank are independent: changing one does not change the other.

SoundFinder™ Feature

Sounds of similar types can be selected using ENSONIQ's exclusive SoundFinder feature. SoundFinder searches for the next or previous sound of the same type. It searches through all of available memory, including the a:CARD and b:CARD sound banks (if a PCMCIA card is installed). General MIDI sounds are not accessible with SoundFinder.

In Select Sounds Mode:

1. Select a sound.
2. Press either {SOUNDFINDER} button. If you press {<}, it will show the previous sound of the same type. If you press {>}, it will show the next sound of the same type.
3. Continued presses of the {SOUNDFINDER} buttons will scroll through all sounds in the KT that have the same defined SoundFinder type (as set on Edit Sound page 06). For a complete list of the SoundFinder types, see *Section 6 — Standard Sound Parameters*.

In Sequences/Presets Mode:

When you press the {REPLACE_TRACK_SOUND} button (its LED is lit), you can press the {SOUNDFINDER} buttons to scroll through sounds that have the same defined SoundFinder Type. This is a great way to hear all available variations of a particular type of sound, and it is very useful in auditioning similar sounds for a sequence or song track. Note that you can audition the sounds as the sequencer plays, but to make the changes permanent, you must first stop the sequencer.

1. Select the track that has the sound that you would like to replace with the SoundFinder feature.
2. Press the {REPLACE_TRACK_SOUND} button. Its LED will turn on.
3. Press either {SOUNDFINDER} button. If you press {<}, it will show the previous sound of the same type. If you press {>}, it will show the next sound of the same type.
4. When you've found a sound that you like, press {REPLACE_TRACK_SOUND} again. You've just replaced a sound on a track using the SoundFinder feature.

Tip: By double-clicking the {REPLACE_TRACK_SOUND} button (LED flashes), you can use the {SOUNDFINDER} buttons to select sounds by type along with their effect settings, just as you would in Select Sounds mode.

Tip: On Edit Sound page 06, the SoundFinder Type=CUSTOM setting can be used to define your own special purpose sound type to help you quickly find your own sounds with SoundFinder. ENSONIQ sounds will never be released with SoundFinder Type=CUSTOM. For more information about the SoundFinder Type parameter, see *Section 6 — Standard Sound Parameters*.

Selecting Sequences/Presets or Songs

To select a KT Sequence/Preset or Song:

1. Press {SELECT_SEQ/PRESET}. This places the KT in Select Sequence/Preset mode and the {SELECT_SEQ/PRESET} LED will light. Once in Select Sequence/Preset mode, it is not necessary to press the {SELECT_SEQ/PRESET} button again to select a new Sequence/Preset.

When the {SELECT_SEQ/PRESET} LED is on, the upper and lower {0} to {9} buttons are used to call up the sounds in memory, one at a time, allowing you to select the one you want to play.

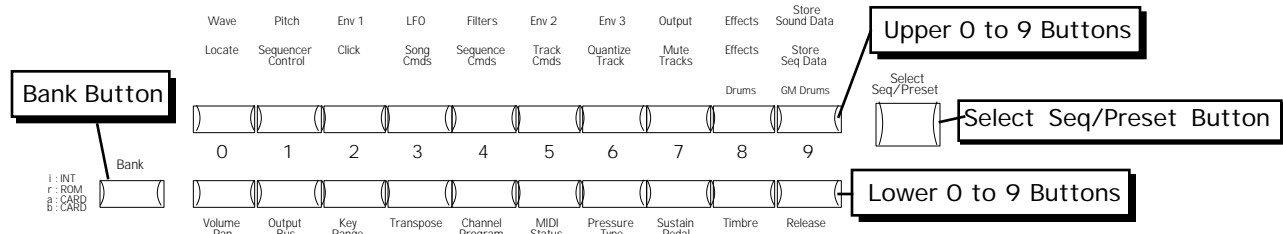

2. Press the upper {0} button, then the lower {0} button.
You have just selected Seq/Preset #00.
3. Press the upper {7} button, then the lower {0} button.
You have just selected Song #70. Try selecting and playing a few different seq/presets.

Sequencer Memory Configuration

There are four banks of 70 Presets/Sequences and 30 Songs, each available in the KT (i:INT (RAM), r:ROM, a:CARD and b:CARD):

- i:INT — 70 Presets/Sequences and 30 Songs can be stored in the KT Internal RAM Memory (Random Access Memory). The i:INT sequencer bank contains room for 6500 events (events are recorded data such as keys pressed, controller information, etc.).
- r:ROM — Additional Presets/Sequences and Songs are permanently stored in ROM (Read Only Memory). Like the Internal (i:INT) sequencer data the ROM sequencer data is contained within the KT; but unlike the Internal (i:INT) sequencer data, it cannot be modified or replaced. The Demo Song is found in r:ROM page location 70.
- a:CARD and b:CARD — 140 Presets/Sequences and 60 Songs can be stored in an industry-standard PCMCIA card (70 Presets/Sequences and 30 Songs in group A, and 70 Presets/Sequences and 30 Songs in group B) which is plugged into the card slot. For more information about Card Sequencer Memory, see *Section 10 — Understanding the Sequencer*.

Play the Demo Song

The KT has a pre-recorded demo song in its ROM. This demo song is designed to demonstrate the KT's ability to create exceptional sequences.

Before playing the Demo Song, changes made to the current preset/sequence/song will be saved or discarded, according to the setting of the SaveChangesMode parameter (found by pressing {EDIT_SEQ/PRESET}, the upper {1}, then the lower {5} button). See *Section 11 — Sequencer Parameters* for more information about the SaveChangesMode parameter.

To play the Demo Song:

- While holding down the {MAKE_DEFAULT_PRESET} button, press the {PLAY} button.
This will select r:ROM Song 70 and will start playback of the Demo Song.

Choosing Internal, ROM, and Card Sequences/Presets/Songs

In Select Sequence/Preset mode, the display shows the bank and page location, and the name of the Sequence/Preset or Song:

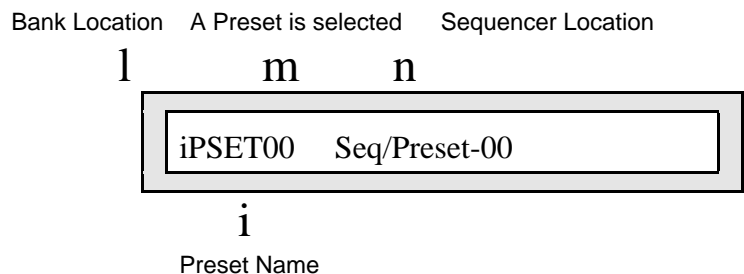

There are two methods that can be used to choose between the four banks:

- **The {BANK} button** — Repeatedly pressing the {BANK} button will step through the various banks. The bank location in the upper left corner of the display will change.
- **Direct-Dialing** — You can reach any of the banks directly by pressing the {BANK} button, and while continuing to hold the {BANK} button down, press one of the lower {0} to {3} buttons.

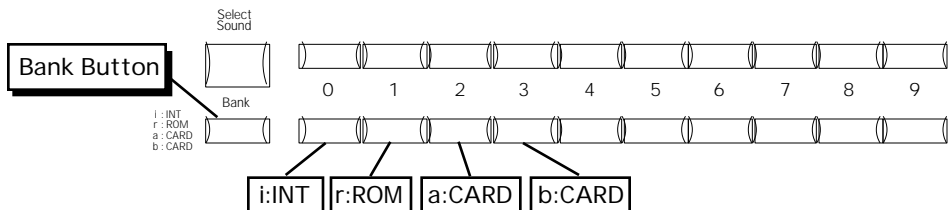

The lower {0} to {3} buttons are used to choose between i:INT, r:ROM, a:CARD and b:CARD sequences/preset/songs. Note that if there is no card installed, or there is no sequencer data on the card, the a:CARD and b:CARD banks will not be recognized.

The current Sounds bank and Seq/Preset bank are independent. Changing one does not change the other.

The KT will default to the last selected i:INT sequence/preset/song location on power on.

Using Parametric Programming

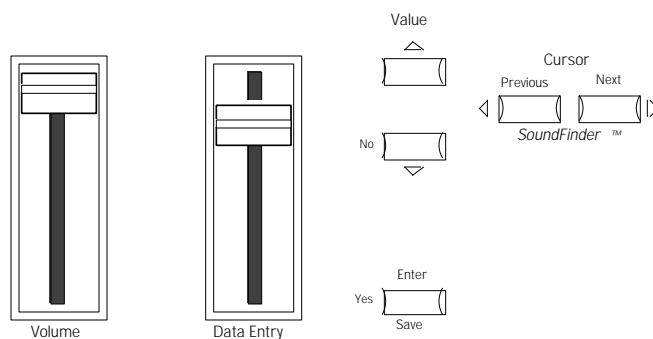

The method used to modify or edit sounds, presets, and system parameters is called Parametric Programming. This may sound complicated, but don't worry. Once you've grasped a few basic concepts, you'll find that operating the KT is quite simple, given its many capabilities.

You may have already encountered some form of parametric programming on other synthesizers. What this means is that instead of having a separate knob or slider for every function, you have one master **Data Entry Slider** and a pair of {VALUE} buttons ({} and {}) that adjust the value of whichever parameter you select. This approach has many advantages, the most obvious is that it greatly reduces the amount of hardware — knobs, switches, faders, etc. — needed to control a wide variety of functions (if the KT had a separate control for each function, it would literally have hundreds of knobs).

Changing a Parameter (Data Editing)

The value of the currently selected parameter on a page is always flashing. Once you have selected a parameter to be modified, use the **Data Entry Slider** or the {VALUE} buttons to adjust its value:

- Moving the **Data Entry Slider** will scroll the entire range of available values. If you move the slider slowly, it will change the parameter relative to the current value. Moving it quickly will cause the parameter to jump to the absolute value that corresponds to the position of the slider.
- Pressing the {VALUE} buttons will increase or decrease the value one step at a time. Continuing to hold down either button will cause it to accelerate, and run quickly through the values.
- When you are editing multiple voices simultaneously, with the EditVOICE parameter set to "ALL" ({EDIT_SOUND}, upper {0}, lower {0}), the {VALUE} buttons will edit the parameter values for each voice relative to each other, rather than to the exact value displayed.

Tip: There is a quick way to center or "zero out" the value of any parameter that has a center value (+00), as the Octave parameter does. While holding down a {VALUE} button, press the other {VALUE} button, then quickly release both buttons. This automatically sets the parameter value to its center value.

If you select another page, change some parameter on that page, and then return to the Pitch page ({EDIT_SOUND} upper {1}, lower {0}), the parameter you had last selected will still be flashing. The KT always "remembers" which parameter was last selected on a given page.

Be sure that the parameter you want to edit is selected before moving the **Data Entry Slider** and/or the {VALUE} buttons. There is always a parameter selected on any given page.

To Change a Parameter

Suppose you want to adjust the pitch of the current voice in the current sound. This is a pitch parameter, so you first need to go to the Pitch page, then you would use the **Data Entry Controls** to select and edit the values.

1. Press the {EDIT_SOUND} button.
2. Press the upper {1} button, then the lower {0} button. The display shows:

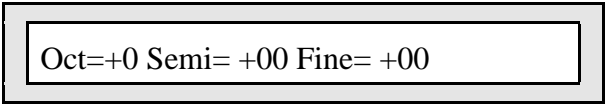

The Oct (octave) parameter comes up in the display. This value segment of this parameter will be flashing, telling you that it has been selected, and can be modified. If the Oct value is not selected (flashing), press the lower {0} button until the Oct value is flashing.

3. To raise or lower the Oct (octave) parameter, press either of the {VALUE} buttons. The display changes, showing the newly selected octave value.

Multiple Parameters

Some KT pages contain more than one editable parameter. When a page with multiple parameters is displayed, there are two methods of moving between parameters:

The {CURSOR} buttons ({<} and {>})	These buttons scroll through each parameter shown on the currently selected page, and then continue to the next or previous page.
The lower {0} to {9} buttons	Repeatedly pressing a lower {0} to {9} button scrolls through each parameter shown on that page, and will not continue to the next or previous page. When a lower {0} to {9} button is held for about one second, the first parameter on that page will automatically be selected.

Section 2 — System•MIDI Parameters

The {SYSTEM•MIDI} button contains several pages that give you control over the KT's system and MIDI parameters. The settings of these global parameters will remain in effect at all times and are preserved while the power is off.

Entering System•MIDI Mode

1. Press {SYSTEM•MIDI} to enter System•MIDI mode.
 2. Press the lower row of buttons ({0} to {9}) to access the various System•MIDI pages. Each lower {0} to {9} button selects a “page” of parameters. Each page may consist of one or more parameters. The **Data Entry Controls** are used to select and edit these parameters.
- Repeatedly pressing {SYSTEM•MIDI} will also scroll through all of the System•MIDI pages.

Exiting System•MIDI Mode

There are several ways to exit System•MIDI mode. Pressing one of the following buttons will exit System•MIDI mode, taking you to another mode:

- Pressing {SELECT_SOUND} will enter Sounds mode.
- Pressing {EDIT_SOUND} will enter Edit Sound mode.
- Pressing {SELECT_SEQ/PRESET} will enter Sequence/Presets mode.
- Pressing {EDIT_SEQ/PRESET} will enter Edit Sequence/Presets mode.
- Pressing {EDIT_TRACK} will enter Edit Track mode.
- Pressing any upper row button ({0} to {9}), will return the KT to the last selected operating mode (Edit Sound mode or Edit Sequence/Presets mode).
- Turning the KT off, then back on will return the unit to Sounds mode with the r:ROM 00 sound selected.

System Parameters

These parameters control global system functions.

System•MIDI

page 0

Tune/Bnd/PTbl

Tune=+00 Bnd=02 PTbl=NORMAL

Tune

Range: -99 to +99 cents

Adjusts the overall master tuning of the keyboard up or down as much as one semitone. A value of +00 will set the KT to concert A=440 tuning.

Note: When Tune is edited, the current value will be transmitted via MIDI, as a Registered Parameter Select message, on the Base MIDI Channel.

Bnd Range: 0 to 12, 1H to 12H semitones

Adjusts the system pitch bend range, which is the maximum amount of pitch bend that can be applied with the pitch wheel (the wheel farthest left). Each value represents a semitone. When the amount is followed by an “H,” only notes sounding from keys that are being held down will be bent. Notes held with the sustain pedal or in their release stage will remain at their original pitch. This feature can be used to create guitar-style pitch bends or to “paint” with pitch, leaving different notes sustaining at different pitches.

Note: When the Bnd parameter is edited, the current value will be transmitted via MIDI, as a Registered Parameter Select message, on the Base MIDI Channel.

PTbl Range: various (see below)

This parameter allows you to set the system pitch-table to either a NORMAL (Western 12-tone equal-temperament) or a custom pitch-table. Pitch-tables will affect all sounds, except Drum Sounds.

Tip: When this parameter is selected (underlined), you can move the **Data Entry Controls** in real time to change the pitch-tables while the sequencer is playing. This can create some interesting and fun effects.

Various ROM System Pitch-Tables

By using the **Data Entry Controls**, you can select from a large assortment of traditional, modern, ethnic, and exotic pitch-tables for use as the System pitch-table. These pitch-tables are:

- **NORMAL** — the KT will use the Western 12-tone equal-temperament tuning for its system pitch-table.
- **PYTHAGRNC** — Early tuning derived by calculating 12 perfect fifths and adjusting the octaves downward as necessary. Leaves all fifths except the one between G# and D# very pure. The entire mathematical anomaly encountered by tuning up 12 perfect fifths (called the Pythagorean comma) is accounted for in the interval between G# and D#.
- **JUST INT-C** — Designed so that the major intervals in any scale are very pure, especially the third and fifth.
- **MEANTONE-C** — One of the earliest attempts to derive a tuning which would accommodate music played in a variety of keys. The major third interval is very pure.
- **WRKMEISTR-C** — Derived by Andreas Werkmeister, a contemporary of Bach, this is a further attempt to create a temperament which would accommodate music played in any key.
- **VALLOTTI-C** — A variation of Pythagorean tuning in which the first 6 fifths in the circle of fifths are flat by 1/6 of the Pythagorean Comma. This is probably close to the tuning used by Bach for his Well-Tempered Clavier.
- **GRK-DIATONC** — The basic building block of ancient Greek music (in which most modern Western music has its roots) was the tetra chord - four notes and three intervals spanning a perfect fourth. The placement of the two inner notes of the tetra chord determined its genus — diatonic, chromatic or enharmonic. This pitch-table is derived from two diatonic tetra chords, combined to form a seven-note scale similar to the modern diatonic scale. It is to be played only on the white keys. Tone center is E.
- **GRK-CHROMAT** — This pitch-table is derived from two chromatic tetra chords (the intervals are, roughly, quarter-tone, half-step, major third), combined to form a seven-note scale. It is meant to be played on the white keys. Tone center is E.
- **GRK-ENHARM** — This pitch-table is derived from two enharmonic tetra chords (the intervals are, more or less, two quarter-tones followed by a major third), combined to form a seven-note scale. It is meant to be played on the white keys. Tone center is E.

- **TURKISH-A** — This is a typical Turkish octave-based scale using only one quarter tone. The second note in the scale is tuned 40 cents flat from the equal-tempered equivalent; in this tuning B is 40 cents flatter from B natural. The scale rises from A.
- **ARABIC-1** — The intervals in this table form the basis for much Middle Eastern music. Here the octave is divided into 17 intervals, corresponding to the fret intervals of some stringed instruments used in this area. The scale rises from the base pitch of C4 in a series of three repeating intervals (in cents) of 90, 90, 24; and so on. From C4 to F5 represents an octave.
- **ARABIC-2** — Similar to Arabic 1, except that here the octave is divided into 24 intervals. This makes one pitch octave cover two keyboard octaves, meaning that the fingering will be the same in any octave. This scale rises from the base pitch of C4 in a series of four repeating intervals (in cents) of 24, 66, 24, 90; and so on.
- **ARABIC-3** — This is a 12-tone scale using quarter tones (notes tuned sharp or flat by 50 cents from their equal-tempered equivalents) on the C#, E, G# and B keys.
- **ARABIC-4** — Another octave-based scale with an Arabic flavor. In this case the “quarter tones” are not perfectly equal, imparting a distinctive character to the notes.
- **JAVA-PELOG1** — One of the two main scales of the gamelan orchestras of Java and Bali is the seven-tone scale called Pelog. The notes C, D, F, G, and A (which are reproduced on the black keys) are considered primary, with E and B used for grace notes. The octaves are stretched (tuned a little sharp) due to the harmonic content of the instruments in the gamelan. (Note that there are many subtle variations of these tunings, almost as many as there are gamelan ensembles. The tunings we have included here are to be considered typical, not definitive.)
- **JAVA-PELOG2** — This is another version of the seven-tone Pelog scale used in gamelan music. The notes C, D, F, G, and A (which are reproduced on the black keys) are considered primary, with E and B used for grace notes. The octaves are stretched (tuned a little sharp) due to the harmonic content of the instruments in the gamelan.
- **JAVA-PELOG3** — A third version of the seven-tone Pelog scale used in gamelan music. The notes C, D, F, G, and A (which are reproduced on the black keys) are considered primary, with E and B used for grace notes.
- **JAVA-SLNDRO** — This is a 15-tone equal tempered tuning from Java. Playing every third note (as in a diminished chord) yields a typical 5-tone scale of the gamelan. Other notes can be used as passing tones.
- **JAVA-COMBI** — This is actually two pitch-tables in one. The white keys play the seven-tone Pelog scale, same as the table JAVA-PELOG1. The black keys play a five-tone scale called Slendro, which is close to a five-tone equal-tempered scale. Both tunings have their octaves stretched (tuned a little sharp) due to the harmonic content of the instruments in the gamelan.
- **INDIAN-RAGA** — Indian scale used to play ragas, based on 22 pure intervals called Srutis. This pitch-table uses two keyboard octaves to play one octave in pitch. The 22 Srutis are mapped to keys in this two-octave range omitting the A#s, which play the same pitch as the adjacent A.
- **TIBETAN** — This tuning is based on a pentatonic scale from Tibet. Notice that playing the black keys yield a scale similar to the 5-tone Slendro tuning from Indonesia.
- **CHINESE-1** — This is a seven-tone scale used widely in China. It is meant to be played on the white keys.
- **CHINESE-2** — This is a seven-tone scale based on an ancient Chinese lute tuning. It is meant to be played on the white keys.
- **THAILAND** — This is a seven-tone equal-tempered scale from Thailand. It is meant to be played on the white keys.
- **24-TONE-EQU** — Centered on C4, this scale has an even quarter tone (50 cents) between each keyboard note, and each pitch octave covers 2 keyboard octaves. This tuning has been used

by many contemporary composers and can be used in some Middle Eastern music.

- **19-TONE-EQU** — Centered on C4, this scale divides the octave into 19 equal steps. From C4 to G5 forms an octave. This scale yields very pure thirds and sixths, but not fifths. Like the 24-tone scale, this has been used by some modern composers.
- **31-TONE-EQU** — Centered on C4, this scale divides the octave into 31 equal steps. From C4 to G6 forms an octave. Similar to 19-tone in the purity of its intervals.
- **53-TONE-EQU** — This scale divides the octave into 53 equal steps. From C2 to F6 forms an octave. It yields very pure thirds, fourths and fifths.
- **HARMONIC** — This is a mathematically generated scale based on the relationships of the partials in the harmonics of the fifth octave of the linear harmonic spectrum. It is interesting mostly from a theoretical standpoint.
- **CARLOSALPHA** — The first of three scales derived mathematically by Wendy Carlos in the search for scales with the maximum purity of primary intervals, Alpha is based on the division of the octave into 15.385 equal steps (78 cents per key). One pitch “octave” covers 16 keys, though because the Carlos scales are asymmetric (not based on whole number divisions of the octave) they do not yield pure octaves.
- **CARLOS-BETA** — Wendy Carlos’ Beta scale is based on the division of the octave into 18.809 equal steps 63.8 cents per key. One pitch “octave” covers 19 keys, though, again, being asymmetric it yields no pure octaves.
- **CARLOSGAMMA** — Wendy Carlos’ Gamma scale is based on the division of the octave into 34.188 equal steps (35.1 cents per key). This scale has essentially perfect major thirds, fourths and fifths. One pitch “octave” covers 35 keys, though, again, being asymmetric it yields no pure octaves.
- **PARTCH-43** — Harry Partch was a pioneer of micro-tonality in the early 20th century. He developed this 43-tone-per-octave scale of pure intervals, and even designed an entire orchestra of instruments for music using this scale. The tonal center is found on key D2 (the low D on the 76-note keyboard). This pitch-table has been transposed up an octave to bring the notes into a more usable range.
- **REVERSE** — This pitch-table simply reverses the pitch-tracking of the keyboard, putting the highest notes at the bottom of the keyboard and the highest notes at the top. Lots of fun.

Touch=SYNTH VEL3 Pressure= MEDIUM

Touch

Range: Various (see below)

Allows you to adjust the velocity response of the keyboard to match your playing style and technique. All velocity curves affect both dynamic response of the KT keyboard and the velocity values transmitted via MIDI. There are 14 velocity curves (Touch) settings, shown in the charts on the following pages:

PIANO VEL1	SYNTH VEL1	FIXED V 64
PIANO VEL2	SYNTH VEL2	FIXED V127
PIANO VEL3	SYNTH VEL3	
PIANO VEL4	SYNTH VEL4	
PIANO VEL5	SYNTH VEL5	
PIANO VEL6	SYNTH VEL6	

When using a PIANO velocity curve, pressing a key down very slowly and softly will yield no sound. This is exactly how a real piano key would respond. When using a SYNTH velocity curve, pressing a key down very slowly and softly will always yield a sound. This is the only difference between a PIANO velocity curve and a SYNTH velocity curve.

Note: We recommend starting with the default setting (SYNTH VEL3), then going up or down to find your optimal setting.

Pressure

Range: SOFT, MEDIUM, FIRM, or HARD

This parameter allows you to adjust the pressure of the keyboard to match your playing style and technique. The pressure threshold can be varied between SOFT (minimum force required to bring in pressure) and HARD (maximum force required to bring in pressure).

- SOFT — is for someone with a light touch. With this setting, a minimum amount of pressure is required to reach the maximum level of any pressure-controlled parameter.
- MEDIUM — requires slightly harder pressing to reach maximum pressure levels. This is the default setting.
- FIRM — represents average pressure sensitivity. A FIRM setting should be right for the player with an average touch.
- HARD — is for the strong player who presses the keys hard. It allows the widest possible range of pressure sensitivity.

The KT Velocity Response Curves (Touch)

Velocity Curve Diagram

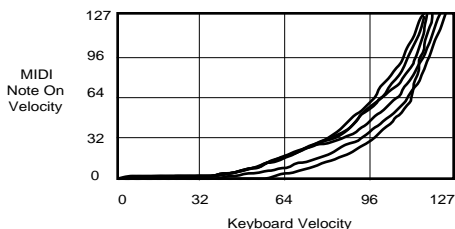

The Velocity Response Curves (Touch) offer control for a wide range of playing styles, as detailed below:

VEL1

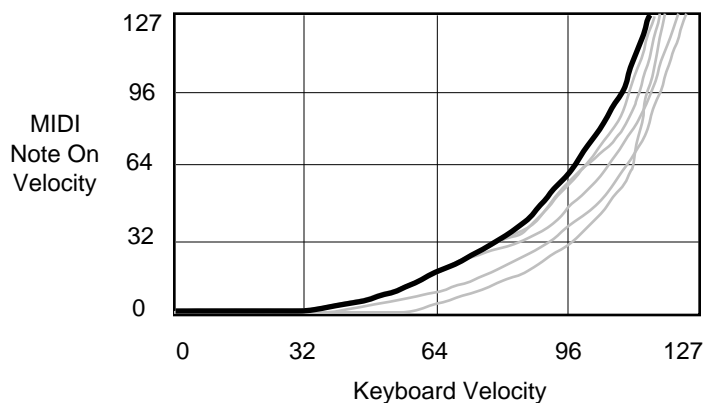

- **PIANO/SYNTH VEL1** — Dark line is (thicker) VEL1. This is for someone with a light touch. On this setting, it is easier to reach the maximum level of any velocity controlled parameter.

VEL2

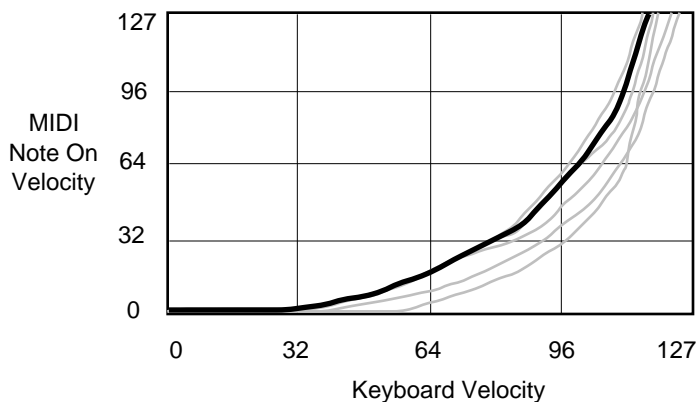

- **PIANO/SYNTH VEL2** — Dark line (thicker) is VEL2. Slightly harder key strikes are required for average playing, but this still allows a softer touch to reach maximum velocity levels.

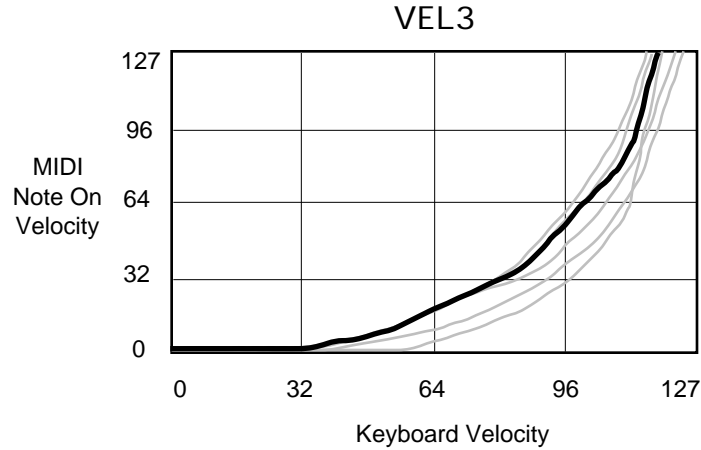

- **PIANO/SYNTH VEL3** — Dark line (thicker) is VEL3. This default setting represents average velocity sensitivity. This setting should be right for most players.

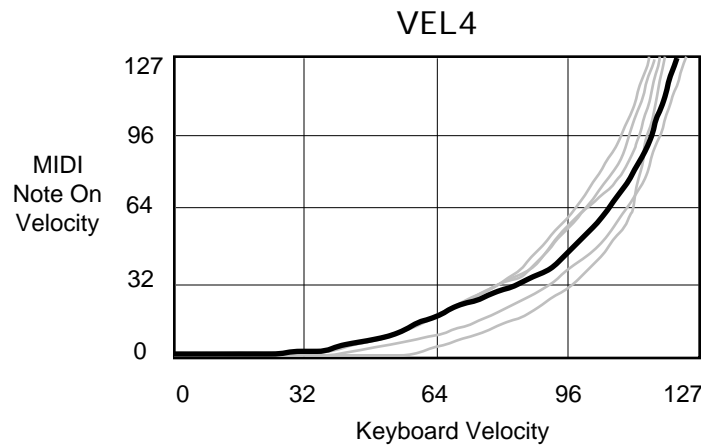

- **PIANO/SYNTH VEL4** — Dark line (thicker) is VEL4. This velocity best represents the “classically-trained” player with strong fingers, and offers the widest dynamic range for skilled pianists.

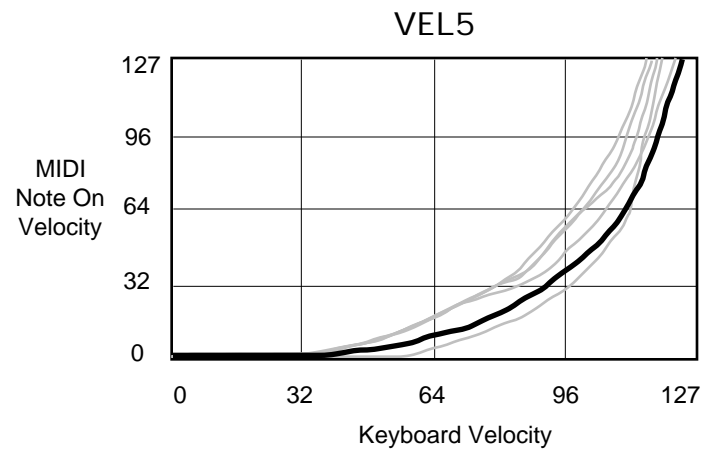

- **PIANO/SYNTH VEL5** — Dark line (thicker) is VEL5. This setting offers a smooth curve for players with strong fingers who desire a softer sound. It requires strong playing to reach the top velocity levels.

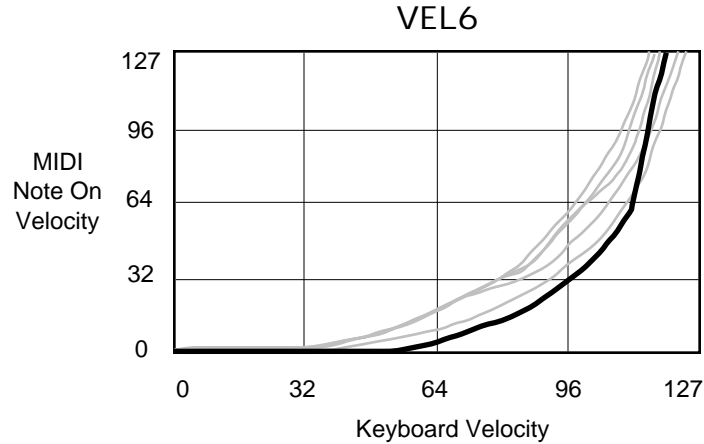

- **PIANO/SYNTH VEL6** — Dark line (thicker) is VEL6. This velocity setting is for the player who wants a lot of control over their softer playing. The curve dedicates most of its range to a gradual increase in volume, with a quick “spike” at the end to still allow full volume accents.

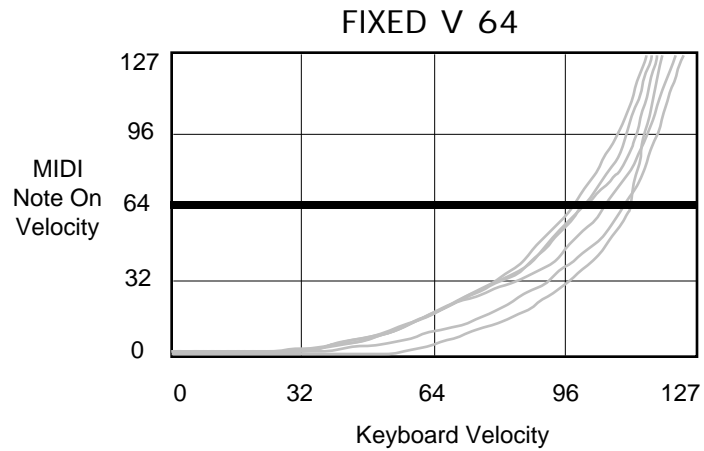

- **FIXED V 64** — With this setting the velocity curve always generates a fixed value, set at the halfway point. This may be useful in simulating vintage synth sounds that originally had no velocity control.

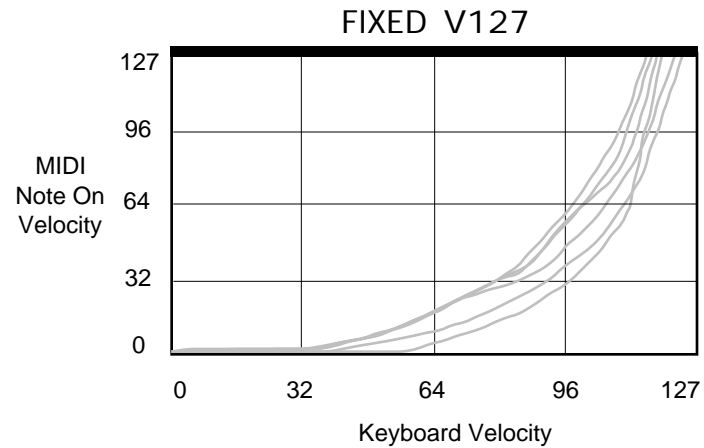

- **FIXED V127** — This setting is also a fixed velocity curve, with full volume. This is good for playing drum/percussion parts when you want a part without dynamic changes.

FtswL=UNUSED FtswR=SUSTAIN

FtswL

Range: UNUSED, SOSTENUTO, or STOP/CONT

Available only when the optional SW-10 Dual Foot Switch is plugged into the KT **Foot Switch** jack, the settings of this parameter will control the function of the left foot switch.

- **UNUSED** — makes the KT ignore the left foot switch. This is the default setting.
- **SOSTENUTO** — the left foot switch will function similarly to the sostenuto pedal on a piano. Any keys that are held down when you press the pedal are sustained until you release the pedal, but keys played after pressing the pedal are not sustained.
- **STOP/CONT** — the left foot switch will start, stop, and continue the sequencer, exactly reproducing the actions of the {STOP"CONTINUE} button on the front panel.

Note: If you are using a single foot switch (SW-2 or SW-6) in the Foot Switch jack, the FtswL parameter should always be set to **UNUSED**. This will prevent note drones. Remember that the **Foot Switch** jack is optimized for use with a stereo foot switch (SW-10). When a single foot switch is connected, it behaves like the right foot switch (FtswR).

FtswR

Range: SUSTAIN, or STOP/CONT

Controls the function of the single damper foot switch (SW-6). When the optional SW-10 Dual Foot Switch is plugged into the KT **Foot Switch** jack, the settings of this parameter will control the function of the right pedal.

- **SUSTAIN** — holding the pedal down will cause notes to sustain after a key has been released, much like the sustain pedal on a piano. This is the default setting.
- **STOP/CONT** — the foot switch will start, stop, and continue the sequencer, exactly reproducing the actions of the {STOP"CONTINUE} button on the front panel.

Latching Pressure with Sustain or Sostenuto

When FtswR=SUSTAIN, or FtswL=SOSTENUTO, the foot switch can be used to dynamically “latch” the current amount of pressure being exerted on the keyboard. Here’s how:

1. Select a sound that responds to pressure. Ideally choose a sustaining sound like an oboe.
2. Play a key and press into the keyboard until you can hear the pressure modulation affect the sound of the note.
3. Press and hold the Sustain or Sostenuto pedal.
4. Release the key. You will hear that the sound continues to be modulated by pressure at the depth to which you were pressing.
5. Play a different key. Notice that the new note is not modulated. You can now press into the keyboard and modulate the new note independent of the note that is sustained. When the current pressure output exceeds the latched level, pressure on the new note will modulate both notes.
6. To release the “latched” pressure value on the sustained note, either press the “latched” key again, or release the Sustain or Sostenuto pedal.

CV-Pedal= VOL #7 Voice Muting=ON

CV-Pedal

Range: VOL #7 or MOD #4

Determines whether the optional CVP-1 foot pedal will act as a volume pedal or a modulator when plugged into the **CV Pedal** jack.

- **VOL #7** — will control the volume of the currently selected sound(s). Transmitted via MIDI as Controller #7.
- **MOD #4** — will affect any voice or effect modulation destination that has PEDAL assigned as a modulation source. Transmitted via MIDI as Controller #4.

Note: The “#7” and “#4” refer to the controller number assigned in the MIDI Specification. See the “MIDI Implementation Chart” in the Appendix.

Voice Muting

Range: OFF or ON

Determines whether all voices currently playing will be shut off when a new sound is selected.

- **OFF** — When you select a new sound, voices that are sustaining from previous sounds will continue to play as long as the key(s) are held down. The old voices will go through the effect settings of the new sound, so they might sound different, especially if the new sound uses a radically different effect.
- **ON** — Whenever you select a new sound, any voices that might be sustaining from the previous sound will be stopped. This is the default setting.

MIDI Parameters

These parameters control instrument-wide MIDI functions.

System•MIDI

page 4

Base Channel/Status

Base Channel= 01 Status = BOTH

Base Channel

Range: 01 to 16

Selects the Base Channel that the KT uses to transmit and receive MIDI messages. The Base Channel is used to transmit and receive MIDI data while the KT is in Select Sound mode. When working within a Preset/Sequence/Song, the KT automatically transmits MIDI data on the individual track channels.

Any of 16 MIDI channels may be selected as the Base MIDI Channel of the KT. The effect of setting the Base Channel varies, depending on the MIDI mode (`{SYSTEM" MIDI} page {6}`) and whether data is being transmitted or received.

- Receive** In POLY mode, keys, controllers, and program changes are only recognized if received on the Base Channel. In MONO A mode, program changes are received only on the Base Channel. The Base Channel is also used in both MONO modes as the first channel of the 8-channel range.
- Transmit** The KT has a fixed MIDI transmitting scheme, depending on the mode it is in. In Select Sound mode, the KT always transmits on the Base Channel. In Seq/Preset mode, the KT always transmits on the individual track channel(s).

Status

Range: BOTH, LOCAL, MIDI, or *EXT*

This determines the MIDI Status of the Base Channel. The four possible settings are:

- BOTH** Keys, controllers, etc., will play KT voices and will be sent via MIDI on the selected MIDI channel. Incoming MIDI will play KT voices.
- LOCAL** Keys, controllers, etc., will only play KT voices, and will not send any data out via MIDI. Incoming MIDI will play KT voices.
- MIDI** Keys, controllers, etc., will be sent out via MIDI when the keyboard is played. However, keys played will not play KT voices. Incoming MIDI will play internal voices. This is comparable to Local Off on some keyboards. Use this status when you want to play remote MIDI devices.
- *EXT*** Same as MIDI Status except that incoming MIDI will not play KT voices. This is useful when using the KT as a Master MIDI Controller with an external sequencer and a number of other remote MIDI devices.

This chart details the behavior of sequencer tracks for each MIDI Status:

Track Status	BOTH	LOCAL	MIDI	*EXT*
Playing the keyboard plays KT voices	YES	YES	NO	NO
Playing the keyboard sends out MIDI	YES	NO	YES	YES
Playing the keyboard will be recorded by the sequencer	YES	YES	YES	YES
Incoming MIDI data plays KT voices	YES	NO	YES	NO
Incoming MIDI data will be recorded by the sequencer	YES	YES	YES	*
Playing the sequencer track (pressing {PLAY}) plays local voices	YES	YES	NO	NO
Playing the sequencer track sends out MIDI	YES	NO	YES	YES

* NO in MULTI or MONO-B modes, YES in OMNI, POLY, and MONO-A modes.

System•MIDI

page 5

Base Channel Pressure

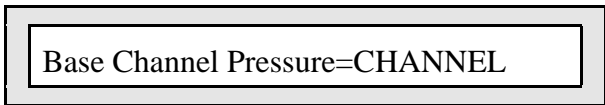

Base Channel Pressure

Range: NONE, KEY, or CHANNEL

Determines which type of pressure the KT will receive on its base channel via MIDI (when MIDI Mode=OMNI, POLY, or MONO-A, see below). This parameter also enables and disables pressure transmission on the base channel to both KT voices and to external MIDI from Select Sound mode.

- **NONE** — The KT will not receive any pressure messages on the Base Channel via MIDI, and the KT keyboard will not generate any channel pressure messages.
- **KEY** — The KT will receive Poly-Key™ (polyphonic pressure) on the Base Channel via MIDI, but the KT keyboard will not generate any channel pressure messages. This type of specialized pressure, which allows individual pressure control over each key, is found on many of ENSONIQ's other keyboards, such as the ASR-10 and TS-10.
- **CHANNEL** — The KT will receive Channel pressure and the KT will generate channel pressure on the Base Channel, affecting both KT sounds and external MIDI. Channel pressure is the most common of the pressure types and will affect the entire keyboard when pressure is added to any key.

Note: The KT keyboard can only generate channel pressure; however, it can receive both channel and Poly-Key pressure via incoming MIDI.

MIDI Mode=OMNI XCtrl = 002

MIDI Mode

Range: OMNI, POLY, MULTI, MONO A or MONO B

This parameter determines how MIDI information will be received by the KT. MIDI mode has no effect on what MIDI information is sent out via MIDI.

There are five MIDI modes implemented in the KT:

1. **OMNI** — In this mode the KT will receive on any or all 16 MIDI channels. This mode is useful when you are only using a few MIDI instruments, and you are not concerned with setting up different channels for each device.
2. **POLY** — In this mode the KT will receive only on the Base MIDI channel. MIDI information on all other channels will be ignored.
3. **MULTI** — An ENSONIQ innovation, MULTI mode is the key to unlocking the potential of the KT as a multi-timbral receiver from an external MIDI sequencer. In MULTI mode, the 8 tracks of the current song or sequence can receive MIDI information independently and polyphonically on up to 8 different MIDI channels. You can easily create empty sequence templates for use in multi-channel reception; see *Section 9 — Preset/Track Parameters* for details.

Different MIDI channels should be selected for each track that you want to receive. This can be accomplished on {EDIT_TRACK} page 4 (see *Section 9 — Preset/Track Parameters* for more information).

In MULTI mode, independent of what sounds are selected on the front panel, the sounds you hear will depend entirely on what MIDI channel(s) the MIDI data is received on, and the MIDI channels assigned to each track.

MONO Mode

MONO mode is particularly useful for driving the KT from a guitar controller, or any other application where having up to eight independent, monophonic channels is desirable.

The KT offers two types of MONO mode operation. In both types, the KT will receive monophonically on eight consecutive MIDI channels starting with the Base Channel (the Base Channel through Base Channel +7). The difference has to do with how those MIDI channels are routed within the KT.

4. **MONO A** — This is another ENSONIQ development intended to make using multi-channel controllers (like MIDI guitars) easier. All notes and controllers received will play whatever sounds are selected for the note that is played, just as if the note was played from the keyboard. You have the advantage of multiple tracks, which will respond independently to controllers received on multiple channels, but you do not have to set up the sounds for each track separately.
5. **MONO B** — This is the more conventional type of MONO mode. It allows you to set up each track of the current song or sequence as a monophonic synthesizer. Each track can have a different program assigned to it. This is the only way to get a different sound on each string when using a MIDI guitar controller.

Using Global Controllers in MONO Mode

Global controllers are controllers sent on one channel that affect all other channels simultaneously. They can be useful in reducing the number of MIDI events required to achieve particular effects, and can thereby reduce the delays sometimes associated with overloading MIDI. Some guitar controllers can transmit global controllers, and the KT can respond to them.

In MONO mode (A or B) the base channel minus one becomes the MIDI channel for global controllers (pitch bend, pressure, etc.). For example, if the base channel is channel 3, any controllers received on channel 2 will be interpreted as global controllers and will affect *all* sounds being played. If the base channel is channel 1, channel 16 becomes the channel for global controllers. Each track will also respond independently to controllers sent on its own channel. For example, each guitar string on a MIDI guitar can send independent pitch bend, while the “whammy bar” controller could be sent on the global channel to affect all sounds.

XCtrl Range: 000 to 127

Use XCtrl to assign external MIDI controllers to affect the KT.

Most controllers on a synthesizer — mod wheel or breath controller, for example — have a MIDI controller number that can be assigned to this parameter. Doing so will make a particular external controller available as a modulator to any of your sounds.

One modulation source that can be selected in Edit Sound mode is XCTRL. The value of the “XCtrl” parameter is a MIDI controller number. When the KT receives MIDI Controller messages corresponding to this controller number, they will be routed to all parameters that have been programmed with XCTRL as a modulation source. Suppose, for example, you are playing the KT from a keyboard with a breath controller (or want to use a breath controller as a modulator when playing the KT keyboard). You can set up a sound on the KT in which the filter cutoff frequency is modulated by XCTRL. If you then set “XCtrl=02,” the breath controller can modulate the filter, or any other voice or effect parameter that has its modulation source set to XCTRL, in the sound you have created.

The following controller numbers are commonly supported:

Number	Controller	Number	Controller
1	Modulation Wheel	64	Sustain
2	Breath Controller	66	Sostenuto
4	Foot Pedal	70	Sound Variation (Patch Selects)
6	Data Entry MSB	71	Harmonic Content (Timbre)
7	Volume	72	Release Time
10	Pan	73	Attack Time
12	Effect Modulation	74	Brightness

Controllers/Prog Change

Controllers= OFF Prog Change= OFF

Controllers

Range: OFF or ON

This controls whether the KT will send and receive MIDI controllers — pitch bend, mod wheel, volume, sustain pedal, etc. This parameter does not affect how controllers function for local sounds.

- OFF — the KT will not send or receive any MIDI controllers.
- ON — the KT will send and receive MIDI controllers.

Prog Change

Range: OFF or ON

This controls how the KT handles MIDI program change messages.

- OFF — the KT will not transmit or receive MIDI program changes or MIDI Bank Select messages.
- ON — the KT will transmit and receive program changes and Bank Select messages over MIDI.

Program Changes in the KT

The sounds in all banks are assigned MIDI Bank Select numbers and program numbers. The KT's **MIDI Out** will send the appropriate MIDI Bank Select message whenever the bank (i:INT, r:ROM, a:CARD, or b:CARD) is changed.

- Internal RAM sounds (i:INT banks) are numbered from 001 to 079.
- r:ROM sounds are also numbered from 001 to 079.
- Card sounds (a:CARD or b:CARD banks) are numbered from 001 to 079.
- The r:DRUM ROM sounds are numbered from 080 to 099.

Bank Select and Program Change Implementation

The way in which the KT receives program changes is slightly more complex than some other systems, because the number of sounds that are available to be selected from MIDI is larger than the number of program change messages available within the MIDI standard. To solve this problem, the KT uses MIDI Bank Select numbers (LSB 0 to 3) to control how subsequent program changes will be interpreted. The following chart shows the effect of these four Bank Select messages:

After MIDI Bank Select:	Subsequent program changes will select:
LSB 0	000..079 - i:INT sounds
LSB 1	000..079 - r:ROM sounds
LSB 2	000..079 - a:CARD sounds
LSB 3	000..079 - b:CARD sounds

These MIDI Bank Select values need to be sent **only once**. All subsequent program changes will be directed to the Bank that was selected by the last Bank Select message received.

Note: Incoming Program Changes 80 to 99 will always select one of the 20 r:DRUM ROM Sounds.

Selecting a New Sound and its Effect from MIDI

There is a special range of MIDI Bank Select messages, recognized only in MULTI mode, which are used to select both a sound and its effect for one of the eight sequencer tracks. When Bank Select value +10 is received on a channel assigned to a sequencer track, then the next program change received on that track will select a new sound and will also install the effect from that sound as the new sequence (or song) effect. This can be useful when controlling the KT from an external sequencer.

After MIDI Bank Select:	Subsequent program changes will select:
LSB 10	000..079 - i:INT sounds with its effect
LSB 11	000..079 - r:ROM sounds with its effect
LSB 12	000..079 - a:CARD sounds with its effect
LSB 13	000..079 - b:CARD sounds with its effect

SysEx/ID/Song Select

SysEx=ON ID=01 Song Select= OFF

SysEx

Range: OFF or ON

This parameter determines if the KT can receive MIDI System Exclusive messages. When SysEx=OFF, the KT does not receive any MIDI System Exclusive messages. The Sys-Ex messages that are sent from the Storage pages can always be transmitted regardless of the setting of this switch (refer to the *Appendix* for more information about the KT Sys-Ex implementation).

ID

Range: 01 to 16

This allows remote MIDI devices to address the KT via incoming MIDI Sys-Ex without changing the Base MIDI Channel number. Think of this parameter as a higher level of identification. This is also used to identify Sys-Ex messages transmitted by the KT, and is useful if you have more than one KT in a MIDI system.

Song Select

Range: OFF or ON

This determines if the KT will transmit and receive MIDI Song Select messages. When Song Select=OFF, the KT will ignore incoming MIDI Song Select messages, and the KT will not transmit MIDI Song Select messages when sequences and songs are selected. When Song Select=ON, incoming MIDI Song Selects will select the corresponding KT sequence/song locations, and selecting KT sequences and songs will cause the KT to transmit MIDI Song Select messages.

MIDI Song Selects # 00-99 will select KT Sequence/Song locations # 00-99. Conversely, selecting Sequence/Song locations # 00-99 will cause the KT to transmit MIDI Song Selects # 00-99.

MIDI TrkName=OFF MIDI Loop = OFF

MIDI TrkName

Range: OFF or ON

This parameter determines if preset and sequencer tracks that have a MIDI status of MIDI or *EXT* will show the sound name (as do tracks with a LOCAL or BOTH status) or show “MIDI CHAN ##” instead of the sound name.

- OFF — When a track’s status is set to MIDI or *EXT* ({EDIT_TRACK} page 5), any displays that would normally show the track’s sound name will show “MIDI CHAN ##” instead of the name. This is helpful when using the KT as a MIDI master controller, or when sequencing remote MIDI devices, as it shows you at a glance which tracks are playing only over MIDI, and on which MIDI channels.
- ON — The track’s sound name will always appear on the display, no matter what the track’s status may be.

MIDI Loop

Range: OFF or ON

The MIDI Loop parameter controls whether or not the Track Vol parameter (Edit Track page 1), will transmit via MIDI. It only affects tracks that have their MIDI Status set to MIDI. It is normally OFF, but in a MIDI loop setup, it should be ON.

- OFF — This is the default setting. When changes are made to the Track Vol parameter (on tracks with Status=MIDI), the KT will transmit MIDI volume (controller 7) messages that combine the Track Vol setting with the current setting of the volume pedal.
- ON — The KT will *not* transmit changes made to the Track Vol parameter on tracks with Status=MIDI. Volume pedal changes will be transmitted directly and are unaffected by the Vol setting.

When MIDI Loop=OFF, then the Vol parameter (Edit Track page 1) is combined (multiplied) with the volume pedal setting to create a composite volume, which is then transmitted to external sound modules as MIDI controller 7. In a MIDI loop situation with a computer, this is undesirable, because lowering the Vol parameter value will send controller messages that are indistinguishable from volume pedal messages. When this information is echoed by the computer, the KT receives it as volume pedal, lowering the volume on that track even further. Eventually this causes the volume to spiral down to zero, which in turn causes the track to be silenced, even though the displayed track Vol setting is greater than zero. Setting MIDI Loop=ON will prevent this problem from occurring.

Note that the volume pedal is only active if CV-Pedal=VOL #7 on System•MIDI page 3, and that volume pedal changes will always be transmitted as MIDI volume (controller 7).

Section 4 — Effect Parameters

This section offers detailed descriptions of the pages and parameters used in selecting and editing effects. For an overview of the concepts involved, please refer to the previous section.

About Effect Parameters

All effect algorithms are found in both Edit Sound and Edit Sequence/Preset modes on the Effects pages (press either {EDIT_SOUND} or {EDIT_SEQ/PRESET} followed by the upper {8} button). The effect algorithms described in this section have various pages. Pages contain parameters associated with the effect algorithm. Some of the parameters are common to many effect algorithms and some are specific to a particular effect algorithm. The first page is identical for all of the algorithms: it shows the algorithm name and the FX1 and FX2 mix. The remaining sub-pages are variable and contain parameters that are relevant to that effect. All of these parameters are programmable and can be used to customize each effect algorithm.

Effect Modulation Parameters

The Effect Modulation parameters, found on the last sub-page of each algorithm, are identical for all the algorithms, and are explained in detail in *Section 3 — Understanding Effects*.

DRY/BYPASSED

This utility algorithm routes FX1 and FX2 dry without any effects processing. This is useful when you want to hear a sound without any effects coloration.

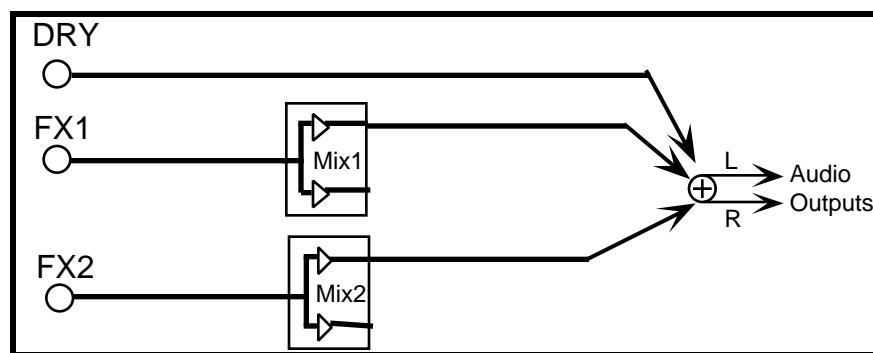

DRY/BYPASSED Routing

FX1 and FX2

Ranges: 00 to 99

These parameters control the mix of silence with a dry audio signal. The FX1 and FX2 parameters can be assigned different levels, and used as volume sub-mixes for tracks in a preset, sequence, or song. 00 is silent and 99 is full volume.

Tip: By assigning a modulation controller to one of these parameters, you can change the volume mixes of a group of tracks in real time, independent of the track volume settings.

Modulation Destinations

FX1-MIX	FX2-MIX
---------	---------

DUAL EQ+REVERB

DUAL EQ+REVERB combines two discrete EQs (one on each bus) with a digital reverb. The amount of reverb on the FX1 and FX2 busses is independently adjustable.

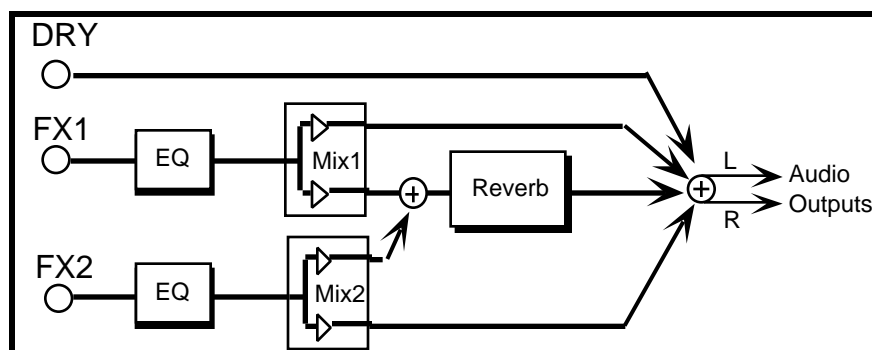

DUAL EQ+REVERB Routing

The parameters available in this algorithm are:

FX1 F Range: 50 Hz to 10 KHz

Sets the center frequency of the EQ assigned to FX1.

Gain Range: -18 to +12 dB

Sets the amount of boost or cut applied to the FX1 EQ.

Warning! Do not set these levels too high, as excessive gain levels may cause damage to your speakers and/or hearing.

BW Range: 50 Hz to 10 KHz

This parameter is a bandwidth control that determines the range of affected frequencies. By raising the value, you can affect a broader range of frequencies.

Out Range: -18 to +12 dB

Adjusts the output volume after the FX1 EQ. With the Gain parameter set to high values, the OUT parameter could be used to create a raspy distortion effect.

Warning! Excessive gain levels may cause damage to your speakers and/or hearing.

FX2 F Range: 50 Hz to 10 KHz

Sets the center of the EQ assigned to FX2.

Gain Range: -18 to +12 dB

Sets the amount of boost or cut applied to the FX2 EQ.

Warning! Excessive gain levels may cause damage to your speakers and/or hearing.

BW Range: 50 Hz to 10 KHz

Sets the bandwidth for the FX2 EQ.

Out Range: -18 to +12 dB

Adjusts the output volume after the EQ.

Warning! Excessive gain levels may cause damage to your speakers and/or hearing.

Rev Range: Various

Allows you to select one of the 16 pre-programmed reverb variations, as explained in *Section 3 — Understanding Effects*.

Decay Bias Range: -7 to +7

This parameter offers fifteen pre-programmed decay time variations, for quick access in creating custom effects. Positive values offer longer decay times, negative values shorten the decay times.

Note: Whenever the reverb variation (Rev) is changed, the Decay Bias parameter is reset to +0, so that the reverb variation can be heard in its originally intended form.

Modulation Destinations

FX1-MIX	FX2-MIX	EQ1FREQ	EQ1GAIN
EQ1BW	EQ1OUT	EQ2FREQ	EQ2GAIN
EQ2BW	EQ2OUT	DECAY	

WARM CHAMBER

WARM CHAMBER is a characteristically resonant chamber reverb. The FX1 and FX2 busses are independently adjustable.

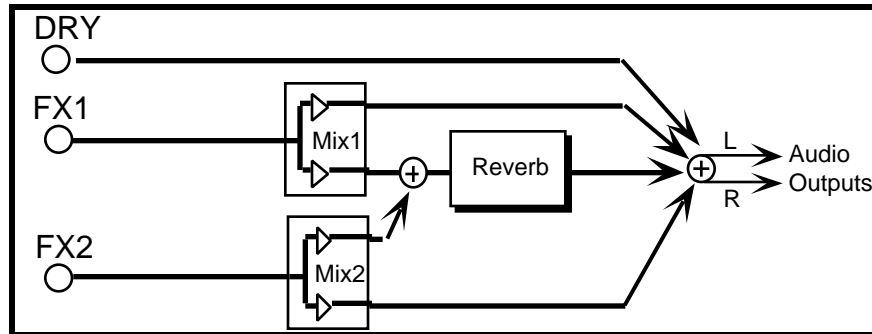

WARM CHAMBER Routing

The parameters available in this effects algorithm are:

Decay Time Range: 00 to 99

Sets the amount of time it takes for the reverberation to fade to a very low level (-60 dB) after the input signal stops.

Diffusion Range: 00 to 99

Determines whether the early reflections will appear as a series of discrete echoes (lower values), or will be more diffused (higher values).

Detune Rate Range: 00 to 99

Controls the rate of detuning in the reverb. Detuning creates a slight pitch shift, giving a more natural sounding decay by breaking up resonant nodes.

Detune Depth Range: 00 to 99

Controls how much the pitch will change. Low values yield a resonant, metallic sound. Some voices may require low values.

HF Damping Range: 00 to 99

Controls the high frequency decay of the reverberation. As natural reverb decays, some high frequencies tend to get absorbed by the environment. Increasing the value of this parameter will filter out increasing amounts of high frequency energy during the decay of the reverb.

HF Bandwidth Range: 00 to 99

The High Frequency Bandwidth parameter filters the signal going into the reverb, controlling the amount of high frequencies that will pass into the effect. The higher the setting, the more high frequencies will pass, resulting in an apparently brighter reverb.

Modulation Destinations

FX1-MIX	FX2-MIX	DECAY	DAMPING
---------	---------	-------	---------

8-VOICE CHORUS

This is a complex stereo chorus that uses eight different delays and separately randomized LFOs to produce pitch and amplitude modulation.

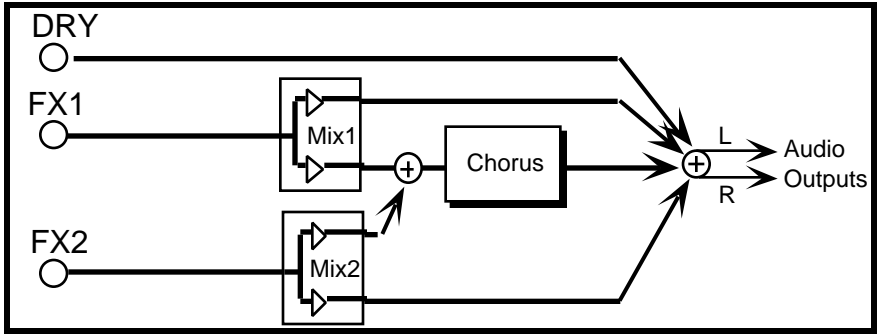

8-VOICE CHORUS Routing

Chorus Rate Range: 00 to 99

Controls the rate of pitch modulation applied to the delays.

Chorus Depth Range: 00 to 99

Controls the excursion of modulation. Since the rate is usually very slow, then the depth is usually very large.

Chorus Center Range: 00 to 99

Controls the nominal delay time of the chorus about which the delay modulation occurs. Adjusting this parameter will change the tonal character of the chorus.

Feedback Range: -99 to +99

Controls the amount of feedback applied to the chorus. Positive settings are in-phase, negative values are out-of-phase, and impart a different tonality to the chorus.

Modulation Destinations

FX1-MIX	FX2-MIX	RATE	DEPTH
CENTER	FDBACK		

EQ-CHORUS+REVERB

This effect combines a four voice chorus with the standard reverb. Assign a voice to FX1 to get both chorus and reverb, or use FX2 for reverb only.

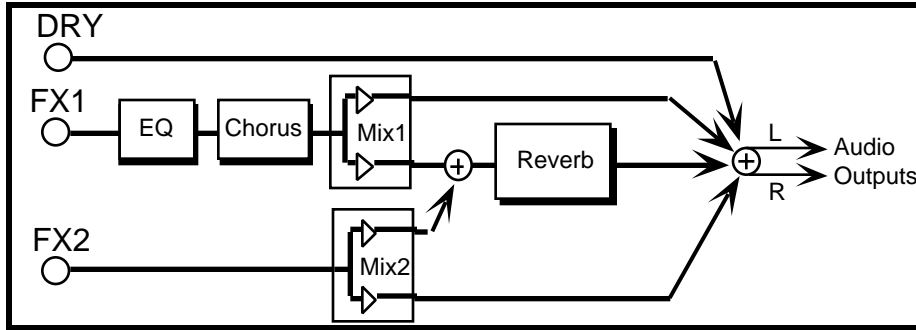

EQ-CHORUS+REVERB Routing

FX1 F **Gain**
BW **Out**

See the description in the Dual EQ+Reverb algorithm.

Chorus Rate Range: 00 to 99

Controls the four rates of the modulation applied to the delay time of the chorus.

Chorus Depth Range: 00 to 99

Controls the amount of modulation. A Chorus Depth of 00 bypasses the chorus.

Chorus Center Range: 00 to 99

Controls the four delay times within the chorus. Adjusting this parameter will change the tonal character of the chorus.

Feedback Range: -98 to +98

Controls the amount of feedback applied to the chorus. Positive settings are in-phase, whereas negative values are out-of-phase, and impart a different tonality to the chorus.

Chorus Level Range: 00 to 99

Controls the Dry/Wet mix of the chorus.

Rev **Decay Bias**

See the description in the Dual EQ+Reverb algorithm.

Modulation Destinations

FX1-MIX	FX2-MIX	EQ FREQ	EQ GAIN
EQ BW	EQ OUT	CH RATE	CH DEPT
CH CNTR	CH FDBK	CH LEVL	DECAY

EQ-DDL+REVERB

Combines a parametric EQ and digital delay, with reverb.

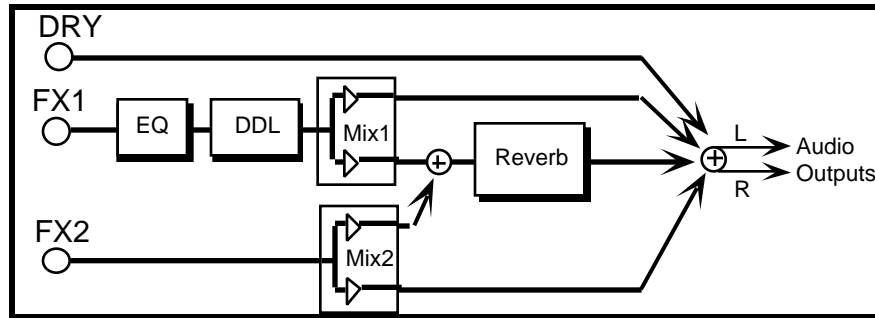

EQ-DDL+REVERB Routing

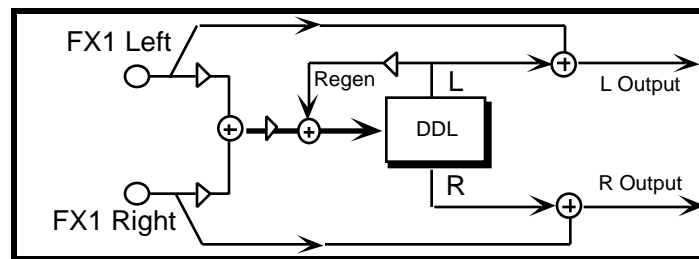

Digital Delay Routing

FX1 F

Gain

BW

Out

See the description in the Dual EQ+Reverb algorithm.

DDL Time L and R

Range: 0 to 700 msec

Sets the delay time for the delays. Experiment with different delay times to find the right setting for your application. See the Delay Times/BPM Chart in *Section 10 — Understanding the Sequencer* for help in setting the delay times to the tempo of a sequence.

DDL Regen

Range: -98 to +98

Controls the amount of regeneration applied to the delay time taps. This affects how long the echoes continue to repeat. Positive or negative values can affect the spatial (phase) relationship of the delay times.

DDL Send

Range: 00 to 99

Adjusts the input level to the delay. A level of 00 will offer no audible delay. Try modulating this parameter with the mod wheel or pressure to selectively choose which notes will echo.

Rev

Decay Bias

See the description in the Dual EQ+Reverb algorithm.

Modulation Destinations

FX1-MIX	FX2-MIX	EQ FREQ	EQ GAIN
EQ BW	EQ OUT	DDL L	DDL R
DDL RGN	SEND	DECAY	

DDL-CHORUS+REVB

A blend of delay and chorusing, with reverb added.

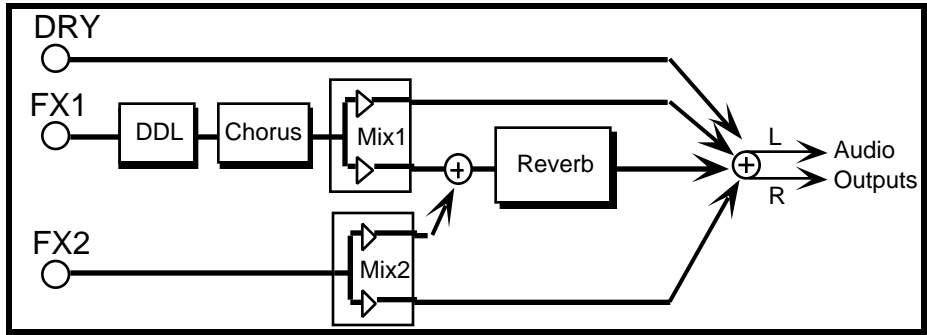

DDL-CHORUS+REVB Routing

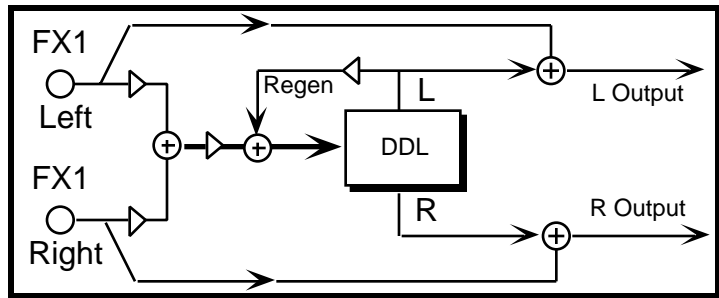

Digital Delay Routing

DDL Time L and R

DDL Regen

DDL Send

See the description in the Dual EQ+Reverb algorithm.

Chorus Rate

Chorus Depth

Chorus Level

Chorus Center

See the description in the EQ-Chorus+Reverb algorithm.

Rev

Decay Bias

See the description in the Dual EQ+Reverb algorithm.

Modulation Destinations

FX1-MIX	FX2-MIX	DDL L	DDL R
DDL RGN	SEND	CH RATE	CH DEPT
CH LEVEL	CH CNTR	DECAY	

ENVCF-CHO+REVERB

ENVCF-CHO+REVERB combines a resonant, envelope-controlled filter and chorus, with reverb. This algorithm can be used to create retro/analog VCF sounds. Assign a voice to FX1 to get filter, chorus and reverb, or use FX2 for reverb only.

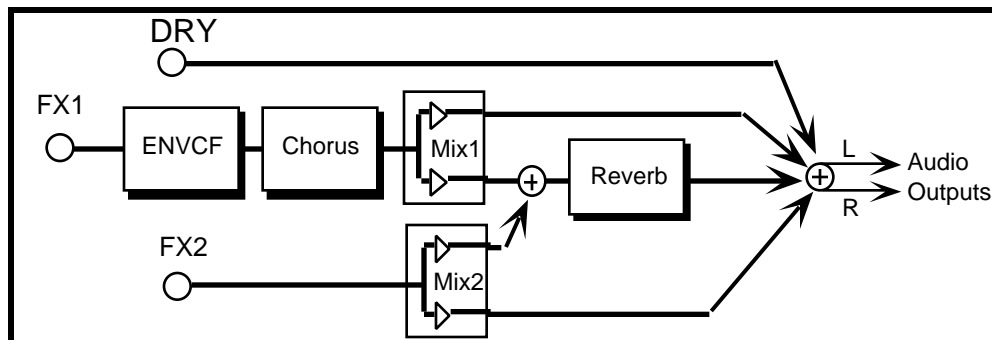

ENVCF-CHO+REVERB Signal Routing

Fc Range: 00 to 99

Determines the filter cut off-frequency. Higher values have a brighter sound. This parameter can be modulated using a CV Pedal for a wah-wah pedal effect. To use as an EQ, set the desired value and make sure Env Amt=00. To use in the classic analog-synth filter mode, set this parameter to a low value and set Env Amt to a higher value.

Qc Range: 00 to 99

Determines the peak at the filter cutoff point. While the Fc parameter determines where (at what frequency) this peak will occur, the Qc setting controls the presence (“sharpness”) of the peak. This setting is important for the analog-synth filter effect.

Trig Mode Range: SINGLE or MULTI

Determines whether the envelope which controls the VCF will retrigger with each key-event (MULTI) or not (SINGLE).

Atck Range: 00 to 99

Sets the time it takes for the filter to open (i.e. to go to its highest frequency). A setting of 00 is instantaneous. This parameter can be used to modulate the frequency of the filter.

Decay Range: 00 to 99

Determines the amount of time for the filter to go from the maximum level achieved during the attack portion to the level set during the sustain portion.

Sust Range: 00 to 99

Sets the level at which the filter will stay until the key is released.

Rels Range: 00 to 99

Determines how long it will take the filter to go from the sustain level to zero after the key is released.

Env Amt Range: 00 to 99

Determines how much affect the envelope will have on the filter’s cutoff frequency. When set to 00, the Atck, Decay, Sustain, Rels, and Trig Mode parameters have no effect.

Kbd Amt

Range: 00 to 99

Determines how much the cutoff frequency will track the keyboard. Set this parameter to work with your signal.

Chorus Rate**Chorus Depth**

See the description in the EQ-Chorus+Reverb algorithm.

Rev**Decay Bias**

See the description in the Dual EQ+Reverb algorithm.

Modulation Destinations

FX1-MIX	FX2-MIX	VCF FC	VCF QC
FC+QC	ENV ATK	ENV DCY	ENV SUS
ENV REL	ENV AMT	KBD AMT	CH RATE
CH DEPT	DECAY		

Modulation Note

In this algorithm, there is an additional modulation destination (FC+QC) that allows you to modulate both the Filter Fc and the filter Qc at the same time using the same mod source. By using a modulator (such as the Mod Wheel) with this setting, the effect will be more resonant as it brightens.

FLANGER+REVERB

FLANGER+REVERB features two LFOs at different rates combined with a reverb. Assign a voice to FX1 to get both flanger and reverb, or use FX2 for reverb only.

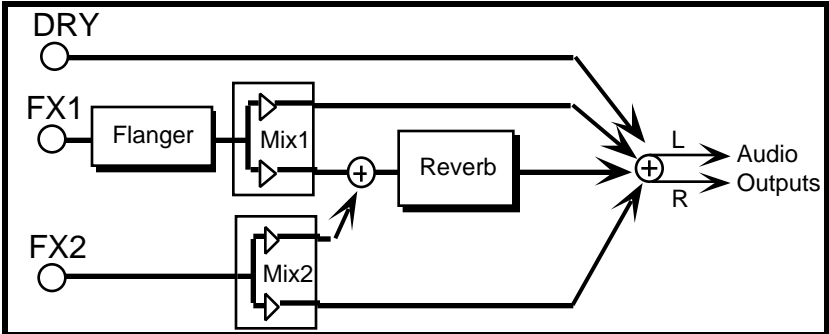

FLANGER+REVERB Routing

Flange Rate Range: 00 to 99
 Controls the rate of the modulation applied to the flange effect.

Flange Depth Range: 00 to 99
 Controls the range of the high-to-low frequency sweep in the flanger effect.

Flange Center Range: 00 to 99
 Sets the sweep mid-point of the flanger effect.

Feedback Range: -99 to +99
 Controls the amount of feedback applied to the flanger. Positive or negative values will impart a different tonality to the flange effect, either accenting the peaks or the notches.

Notch Depth Range: 00 to 99
 Controls the depth of the peaks and notches produced by the flanger. This parameter should be set to 99 for maximum effect.

Input Invert Range: OFF or ON
 Inverts the input signal before combining it with the flanged signal. It creates peaks instead of notches, for a different effect.

Rev

Decay Bias
 See the description in the Dual EQ+Reverb algorithm.

Modulation Destinations

FX1-MIX	FX2-MIX	RATE	DEPTH
CENTER	FDBACK	NOTCH	DECAY

PHASER+REVERB

A 12-pole phase shifter with reverb. Assign a voice to FX1 to get both phaser and reverb, or use FX2 for reverb only.

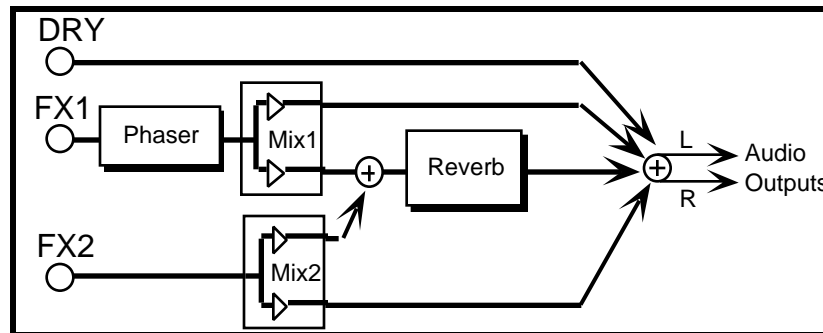

PHASER+REVERB Routing

Phaser Rate Range: 00 to 99

Controls the rate of the modulation applied to the phaser.

Phaser Depth Range: 00 to 99

Controls the amount of modulation applied to the phaser.

Phaser Center Range: 00 to 99

This parameter controls the mid-point of the phaser.

Feedback Range: -99 to +99

Controls the amount of feedback applied to the phaser. Positive or negative values will impart a different tonality to the phaser effect, either accenting the peaks or the notches.

Notch Depth Range: 00 to 99

Controls the depth of the peaks and notches produced by the phaser. This parameter should normally be set to 99.

Input Invert Range: OFF or ON

Inverts the input signal before combining it with the phase-shifted version. It creates peaks instead of notches, for a different effect.

Rev

Decay Bias

See the description in the Dual EQ+Reverb algorithm.

Modulation Destinations

FX1-MIX	FX2-MIX	RATE	DEPTH
CENTER	FDBACK	NOTCH	DECAY

ROTARY SPKR+REVB

A rotating speaker simulation with reverb. Assign a voice to FX1 to get both rotary speaker and reverb, or use FX2 for reverb only.

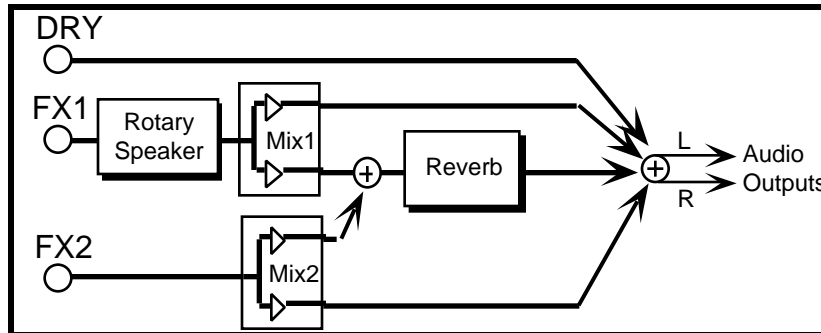

ROTARY SPKR+REVB Routing

Rotor Speed

Range: MIN or MAX

Switches between two different rotor speed settings, as determined by the Speed Min and Speed Max parameters. When modulated, this switch accurately reflects the behavior of an actual rotary speaker, taking time to speed up or slow down, based on the value of the Inertia parameter (see below).

Inertia

Range: 00 to 99

Determines how long it will take for the rotor effect to speed up and slow down after switching from fast to slow or vice versa. Adjust this parameter to imitate the way that a larger or smaller rotary speaker would typically change speeds. This parameter affects both TOGGLE and CONTIN modulation modes (see next page).

Speed Min

Range: 00 to 99

Sets the rotary speaker's "slow" rate when Rotor Speed=MIN, or when the selected modulator is at zero output level. The higher the value, the faster the rate.

Speed Max

Range: 00 to 99

Sets the rotary speaker's "fast" rate when Rotor Speed=MAX. The higher the value, the faster the rate.

AM Min and Max

Ranges: 00 to 99

Controls how much the volume will change as the speaker rotates. Higher values will create a deeper rotating speaker effect.

FM Min and Max

Ranges: 00 to 99

Controls the amount of detuning as the speaker rotates, also known as the "Doppler" effect.

Distortion

Range: 00 to 99

Determines the input gain to the amplifier simulation, creating a tube-like overdrive. Higher settings yield more distortion.

Filter

Range: 00 to 99

This parameter is the distortion tone control. Lower settings will yield a more raspy distortion tone, whereas high settings will give that mellow "amp growl."

Mix Range: 00 to 99

Controls how much of the amplifier distortion is mixed with the clean signal (there is an internal clean path in parallel with the distortion). To eliminate distortion, set this parameter to 00.

Rev

Decay Bias

See the description in the Dual EQ+Reverb algorithm.

Modulate Speed by

This special modulation feature allows you to select a modulator and define what *type* of modulation you want to use to affect the rotor speed. The two modulation modes are:

- TOGGLE — The modulation source toggles the rotor speed between the Speed Min setting and the Speed Max setting. Every time the modulation source moves from zero in a positive direction, the rotating speaker effect changes speeds from slow to fast or fast to slow. To reverse the polarity of the switch, set Speed Min faster than Speed Max. Try this setting with the Sustain pedal.
- CONTIN — The modulation source continuously switches between the Speed Min setting and the Speed Max setting, based on the mod source position and/or movement. Try this setting with the Mod Wheel — you'll hear the rotary speaker change speed based on the position of the wheel (and the Speed Min and Max settings).

With both types of modulation, the rotary speaker *always* takes the Inertia time to get to the Rotor Speed MIN and MAX settings.

FL-CMP-DIST+REVB

A screaming guitar amp simulator that features not only compression, distortion, and reverb, but a flanger and high pass/low pass EQ as well. FX1 routes the signal through each of these effect processors, while FX2 is used for reverb only.

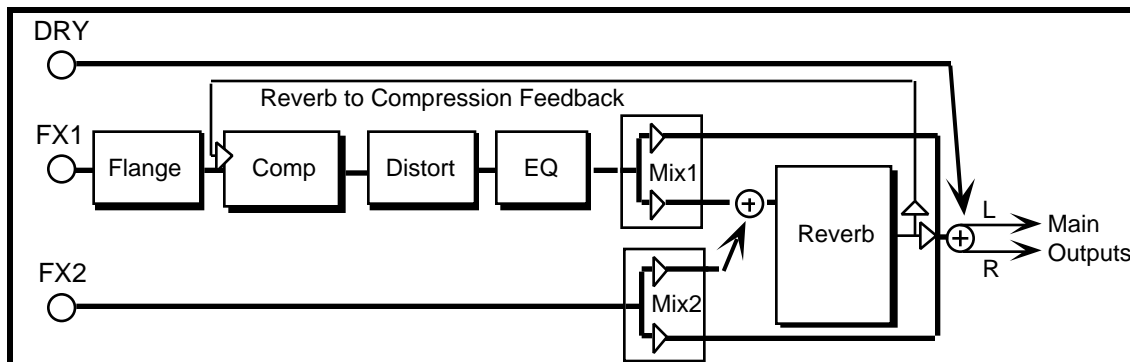

FL-CMP-DIST+REVB Routing

Flange Rate

Range: 00 to 99

Controls the rate of the flanger. Set this parameter to 00 to eliminate the flanger effect.

Compression

Range: 00 to 99

Controls the amount of compression (actually an inverse expander). As the input signal dies away, the compressor will increase the gain of the system, causing feedback to increase as well. The normal compression amount is 72.

Distortion Level In/Out

Ranges: 00 to 11

These two parameters control the levels going into and coming out of the distortion effect. The range for both parameters is 00 to 11, based on the Nigel Tufnel theorem, which states that making 10 louder isn't sufficient, since "These go to 11. 11 is one more, isn't it?"

HiPass Cutoff

Range: 00 to 99

Filters out low frequencies after the distortion signal path. The higher the value, the fewer low frequencies pass through.

LoPass Cutoff Range: 00 to 99

Filters out high frequencies after the distortion signal path. The lower the value, the fewer high frequencies pass through.

Reverb to Cmprss Feedback Range: -99 to +99

Controls the amount of signal applied from the output of the reverb back into the input of the compressor. The sign of the value determines the polarity of the feedback.

Note: Since the feedback level is taken from the FX1 bus, if FX1 is set to 00 or a low value, feedback will have little or no consequence. Also, it is important to note that since the signal is being taken from the reverb, which is also fed by the FX2 bus, voices sent to the FX2 bus will enter the feedback loop with the FX1 signals.

Decay Time Range: 00 to 99

Controls the amount of time it takes for the reverberation to decay to a very low level (-60dB) after the input signal stops.

HF Damping Range: 00 to 99

The High Frequency Damping parameter controls the high frequency decay of the reverberation. As natural reverb decays, some high frequencies tend to get absorbed by the environment. Increasing the value of this parameter will filter out increasing amounts of high frequency energy.

Modulation Destinations

FX1-MIX	FX2-MIX	FDBACK	DECAY
DAMPING			

DISTWAH-CHO+REVB

Overdrive, wah (sweepable filter), chorus, and reverb, with a special serial/parallel routing option. Assign a voice to FX1 to get chorus and reverb with or without distortion (see signal path diagram), or use FX2 for reverb only. Panning voices routed to FX1 can yield three discrete effects — this is useful for multi-timbral sequencing.

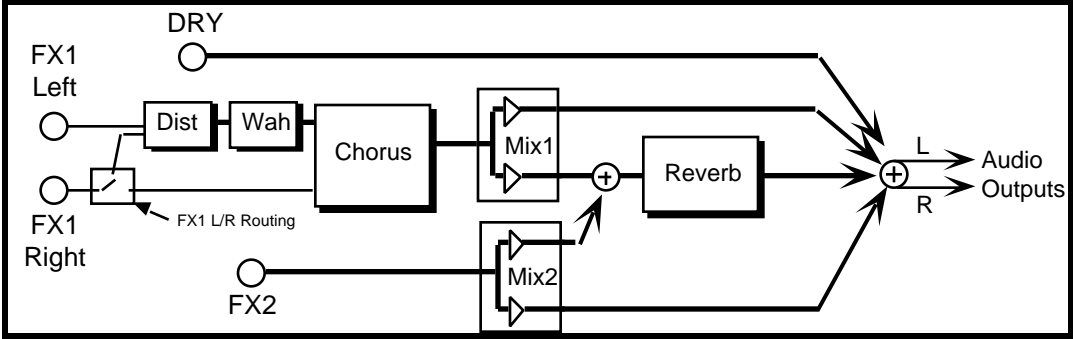

DISTWAH-CHO+REVB Signal Routing

FX1 L/R Routing

Range: see chart

Determines how voices assigned to FX1 will be affected by panning:

When FX1 L/R Routing=	Then:
L+R:DISTWAH-CHO	All voices assigned to FX1 will both go through the DISTWAH-CHO effect.
L:DISTWAH R:CHO	Voices assigned to FX1 and panned Left will go through the DISTWAH-CHO effect (in series). Voices assigned to FX1 and panned Right will go through the chorusing only.

Fc

Range: 00 to 99

This determines the filter cutoff-frequency (brightness) of the distortion.

Qc

Range: 00 to 99

Determines the peak at the filter cutoff point. While the Fc parameter determines where (at what frequency) this peak will occur, the Qc setting controls the presence of the peak.

Dist

Range: 00 to 99

Determines the input signal gain into the amplifier simulation, creating a tube-like overdrive. Higher settings yield more distortion.

Mix

Range: 00 to 99

Controls the mix between the original signal and the distortion (there is an internal clean path in parallel with the distortion). To eliminate distortion, set this parameter to 00.

Chorus Rate

Range: 00 to 99

Controls the rate of the modulation applied to the delay time of the chorus.

Chorus Depth

Range: 00 to 99

Controls the amount of modulation applied to the delay time of the chorus.

Chorus Center

Range: 00 to 99

Controls the delay time center of the chorus.

Feedback Range: -98 to +98

Controls the amount of feedback applied to the chorus. Positive settings are in-phase, negative values are out-of-phase, and impart a different tonality to the chorus.

Chorus Level Range: 00 to 99

Controls the Wet/Dry mix of the chorus itself.

Rev

Decay Bias

See the description in the Dual EQ+Reverb algorithm.

Modulation Destinations

FX1-MIX	FX2-MIX	FILT FC	FILT QC
FC+QC	DISTORT	MIX	CH RATE
CH DEPT	CH CNTR	CH FDBK	CH LEVL
DECAY			

Modulation Note

In this algorithm, there is an additional modulation destination (FC+QC) that allows you to modulate both the Filter Fc and the filter Qc at the same time using the same mod source. By using a modulator (such as the Mod Wheel with this setting, you can create the “wah” effect.

Section 5 — Understanding Sounds

In this section, we will show you how to edit a KT sound. For detailed descriptions of the parameters relating to Standard Sounds, refer to *Section 6 — Standard Sound Parameters*. For detailed descriptions of the parameters relating to Drum Sounds, refer to *Section 7 — Drum Sound Parameters*.

What is a KT Sound?

KT Sounds are divided into two categories; Standard Sounds, which are dynamic structures made up of 3 voices and an effect; and Drum Sounds, which feature 17 voices and an effect. Drum Sounds have slightly different programming features due to their additional voices.

Standard Sounds and Drum Sounds each have their own programming guidelines. See Sections 6 and 7 for details. This section of the manual will cover the “common ground” between the two types of sounds.

Understanding Voices and Polyphony

When referring to the number of voices in a KT sound, we are not talking about polyphony (as in “you can only play so many notes,” see below). We are referring to the number of voices that will sound on each key as you play the sound.

The KT can play a total of 64 voices simultaneously, which are dynamically assigned among the different sounds that you play. How many voices a sound uses on each key depends on two factors:

1. The number of voices that are ON on the EditVoice page.
2. Whether or not the Key Ranges and Velocity Windows overlap.

See *Section 6 — Standard Sound Parameters* for more information on these parameters.

Some sounds use only one voice per key — in these sounds, you can play 64 notes before “voice stealing” occurs. On sounds that use two voices per key, you can play 32 notes before any voices are stolen. Three voices per key, 21 notes. Up to three voices can be active in each Standard Sound.

Drum Sounds are inherently “one voice” sounds, as they always use only one voice per key range, but have up to 17 different ranges (or zones) assigned across the keyboard.

Bear in mind that the KT is “smart” about voice allocation — there are many things that you can do to maximize the polyphony of a sound and to minimize the effects of voice stealing. For example:

- When a voice is done playing (either because it reached the end of the wave or because the volume envelope, Env 3, went to zero) that voice becomes free and a new note can use that voice rather than stealing one that is still sustaining. See “Stealing Notes,” in *Section 6 — Standard Sound Parameters*.
- You can assign low, medium or high priority to each voice in a sound, allowing you to control which voice(s) will be stolen first. See “Output Pages” in *Section 6 — Standard Sound Parameters*.

Using the Compare Button/LED

When you change any parameter in a sound, the LED in the {EDIT_SOUND} button will begin flashing. It will remain flashing until you select another sound, or save (write) the newly edited sound into memory, or to a card. This is a constant reminder that something in the sound has been changed.

To hear the original, unchanged sound, press the {COMPARE} button. The {EDIT_SOUND} LED will remain solidly lit without flashing, you will hear the original sound, and the display shows its original settings. Press {COMPARE} again to return to your edited sound. You can toggle back and forth between the original and the edited sound as often as you like.

Using the Edit Buffer

You can edit a sound while keeping the original sound intact, because the edited version is kept in a special area of memory called the Edit Buffer. Whenever you change any parameter of a sound, the altered sound is put in the edit buffer, replacing whatever was previously there. Only one sound at a time can reside there — the edit buffer always contains the results of your last edit.

When you press {COMPARE}, you are alternating between the sound in the original memory location and the sound in the edit buffer. We refer to the sound in the edit buffer as the Edit Sound.

You can return to the edit sound, even after selecting another sound (as long as you don't change any parameters there) by pressing the {COMPARE} button. This puts you back in the edit buffer, and any changes you make will affect the edit sound.

The rule of thumb is this: Whichever sound you hear, that's what you're editing.

If you like the results of the changes you have made to a sound, you should rename it and save the new sound permanently, to another location. The procedure for this is covered under "Saving a New Sound Into Memory" later in this section.

To Abandon Your Edits

If you decide, while editing a sound, that you're not happy with what you've done, and you want to start over with the original sound:

- Press the {COMPARE} button so the {EDIT_SOUND} LED remains solidly lit. Then you can start editing the sound again from scratch. You *will* lose the edits to the sound you were working on before.

Saving a New Sound Into Memory

After creating a new sound, or editing a sound to better suit your needs, it must be saved into a memory location to be available for future access. New or edited sounds can be saved into any one of the 80 internal RAM sound locations (or to a card, as explained in *Section 13 — Storage*) with the following procedure.

To Save a Sound

1. Check to make sure that the {EDIT_SOUND} LED is flashing. If not, press {COMPARE}. This indicates that the sound you're hearing is in the edit buffer.
2. Press the {SAVE} button. The display will read "Save SOUND <Sound Name>?" The name listed is the name of the sound you began with when editing.
3. Select a name of up to 16 characters for your new sound using the **Data Entry Controls**. The {CURSOR} buttons select the character to be edited (underlined), while the **Data Entry Slider** and {VALUE} buttons scroll through the letters, numbers, and symbols that can be used to name the sound. Moving the **Data Entry Slider** all the way down gives you a blank space. Using dashes, periods and slashes between characters can make a sound name look better when displayed on the Select Sound pages.
4. Press the {SAVE} button again. The display will read " SaveTO <Location> <New-Name>."
5. Select a memory location for your sound using both rows of {0} to {9} buttons and/or the {VALUE} buttons. These buttons will display the names of the programs currently residing in memory. If you have a formatted PCMCIA card installed, you can also press the {BANK} button and select between i:INT, a:CARD, or b:CARD memory locations.

Look for a memory location that contains a sound that you no longer want or use. Sounds that are in memory can be "auditioned" at this point by pressing the {COMPARE} button to toggle between the sound listed on the display, and the sound in the edit buffer. Before continuing, make sure the {EDIT_SOUND} LED is flashing. If not, press {COMPARE} again.

6. When a location has been found, press the {SAVE} button one last time. The display will show a momentary "Saved." message before returning to the current page.

Tip: If you would like your edited sound to be saved in its present memory location (i:INT, a:CARD or b:CARD only), simply "double-click" the {SAVE} button in step 4 above. As in the above procedure, the display will momentarily read "Saved." and then return to the current parameter.

Copying an Existing Sound to Another Location

Sometimes you'll want to take an existing sound, one that you haven't been editing, and simply copy it to another memory location. For example, you might want to put your six most commonly used sounds in the same bank, for easy access during performance.

1. Select the sound you want to copy.
2. Press {SAVE}. The display shows:

Replace edit sound?

3. Press the {YES} button. The selected sound now resides in the edit buffer. Now proceed from step three as described above to write the sound to the new location.

KT Standard Sound Configuration

Each of the three voices within a KT Standard sound has:

- a digital oscillator playing one of the 211 waves from the KT wave memory
- a filter stage comprised of two multi-mode digital filters
- an output stage for amplitude control
- one low frequency oscillator (LFO)
- three complex envelope generators for controlling each of the three stages
- a versatile matrix modulation scheme with 15 routable modulation sources

The following diagram shows the configuration of one KT voice.

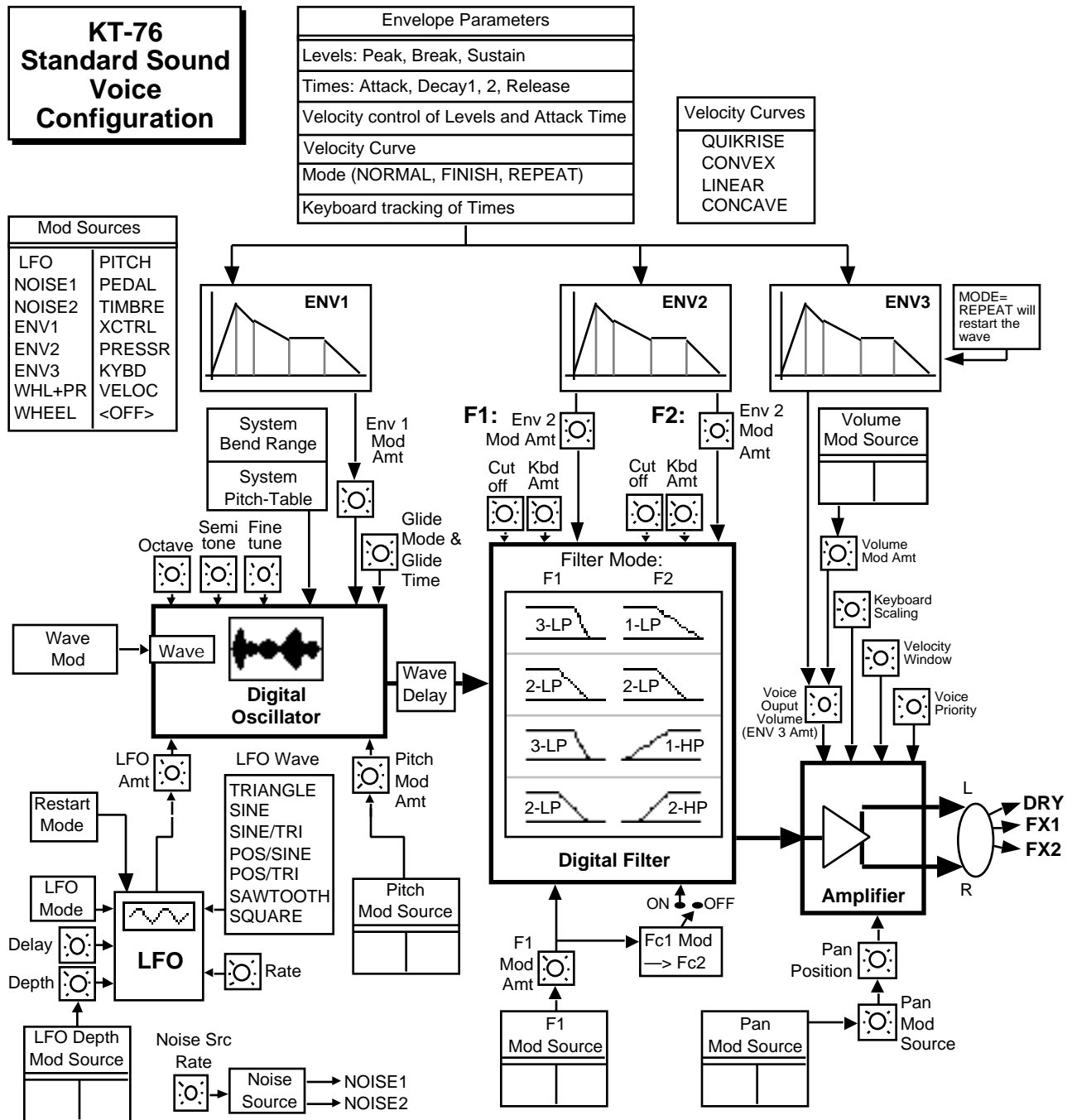

KT Drum Sound Configuration

KT sounds come in two varieties: standard sounds and drum sounds. r:DRUM ROM Sounds are grouped in their own two banks of ten (as shown on the front panel). KT drum sounds differ from standard sounds in two major areas:

Number of Voices

Standard sounds can use up to three layered voices per key range. Drum sounds are based on an underlying General MIDI drum map with 17 definable voices and ranges that can be used to cover the General MIDI drum map. A Drum sound uses only one voice per key range. Each voice can be used as a separate drum or percussion instrument.

Voice Architecture

Each of the 17 voices within a KT Drum sound has:

- a digital oscillator playing any of the drum-related waves from the KT wave memory (DRUM-SOUND, CYMBALS, PERCUSSION, TUNED-PERC, SOUNDEFFECT)
- two multi-mode digital filters that are fixed in a 4-pole low pass mode
- a set of parameters specific to drum sounds

In addition to the 17 voices, a “hidden” ROM General MIDI Drum map resides underneath the 17 drum voices, ready to be used to create a General MIDI drum kit. See *Section 7 — Drum Sound Parameters* for more information.

The pitch-table selected on System • MIDI page 0 will have no effect on Drum Sounds.

All drum sounds are auto-detected by SoundFinder and form their own SoundFinder type. However, SoundFinder cannot differentiate between drum sounds that use the General MIDI Drum Map and those that use the ENSONIQ Drum Map.

KT-76 Drum Sound Voice Configuration

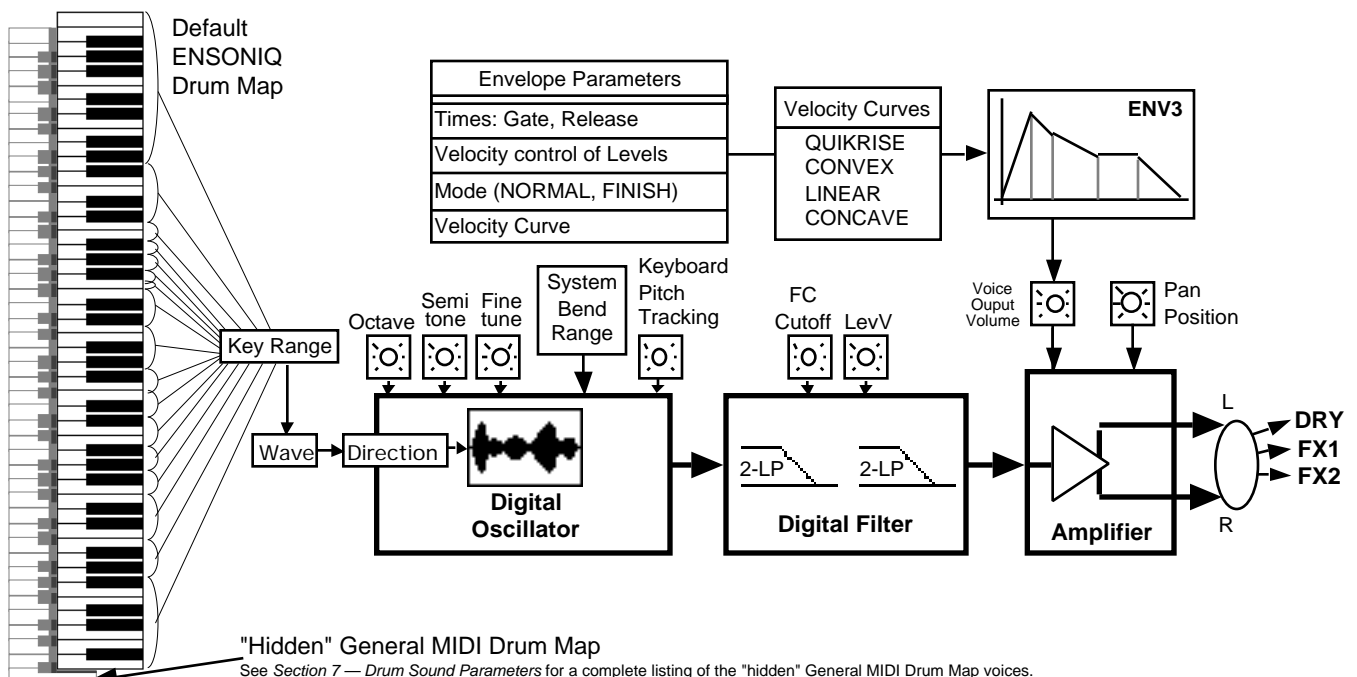

Selecting Edit (Drum) Sound Mode

Because the KT has two types of sounds, it also has two Edit Sound modes: one that pertains to Standard sound editing, and one for editing Drum sounds. To create or edit a Drum sound, you must use Edit (Drum) Sound mode. There are two methods for getting there:

Change Sound Mode Command:

This method for switching Edit Sound modes is useful when you are already in Edit Sound mode. Located in both Edit (Standard) Sound mode and Edit (Drum) Sound modes, this command allows access into the other Edit Sound mode.

When a Standard Sound is selected:

1. Pressing {EDIT_SOUND}, the upper {0}, then the lower {8} button. The display shows “Press ENTER to Change SoundMode.”
2. Press {ENTER}. The display momentarily shows “Command successful!” and then switches to Edit (Drum) Sound mode, with Wave page 00 selected. This places the default drum map into the edit buffer.

When a Drum Sound is selected:

1. Pressing {EDIT_SOUND}, the upper {0}, then the lower {5} button. The display shows “Press ENTER to Change SoundMode.”
2. Press {ENTER}. The display momentarily shows “Command successful!” and then switches to Edit (Standard) Sound mode, with Wave page 00 selected.

Selecting a Drum Sound First:

This method for sound mode hopping is the simple process of selecting sounds. The currently selected sound determines the Edit Sound mode. You can enter the Edit (Drum) Sound mode by first selecting a drum sound.

1. Press {SELECT_SOUND}, then either the upper {8} or {9} button.
2. Press {EDIT_SOUND}.
You have just entered Edit (Drum) Sound mode, with the selected drum sound in the edit buffer.

Using Modulation

About Modulation

To modulate something is simply to cause it to change. Within the voice architecture of the KT, we begin by setting basic, or manual levels for the volume, pitch, brightness, etc. of a voice, and we then modulate those levels in various ways to create movement and dynamics.

Suppose you switch on your stereo, and turn the volume half way up. We can call this the manual volume setting. It will stay at that level until it's changed. Now suppose that you take the volume knob of your stereo and begin quickly turning it up and down, so the volume gets continuously louder and softer, louder and softer. What you would be doing is modulating the volume of your stereo. If you were to take the treble control, and do the same to that knob, you would be modulating the brightness of your stereo.

In much the same way we modulate various levels within the KT (though generally the approach is less haphazard). There are 15 different Modulation Sources available, and they can each be independently assigned to vary the manual levels for a great many aspects of a voice, including real time control of most aspects of an effects algorithm. Programming modulators requires two steps: selecting the mod source and setting the modulation amount (a scaling factor that determines how strongly the modulator affects the voice).

To Select a Modulator

Some programming pages allow you to select a modulator to vary the level of some parameter within a KT voice. The display shows “Mod=_____” (short for Modulation Source). A modulator is selected using the **Data Entry Slider** or the {VALUE} buttons to choose among the 15 available modulation sources.

Let's take, for example, the Pitch Modulation parameter, which is where you apply modulation to the pitch of a voice:

1. Select a Standard Sound, and press the {EDIT_SOUND} button.
2. Press the upper {1} button.
3. Press the lower {1} button.

Besides Envelope 1 and the LFO, which are always available as pitch modulators, you can choose an additional modulator to alter the pitch:

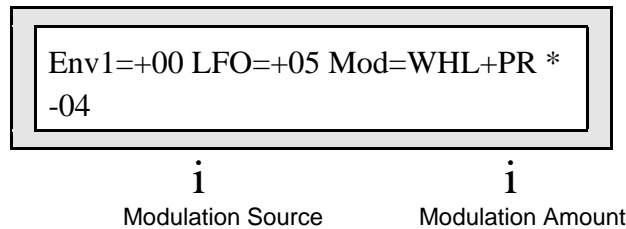

To Control Modulation Amount

As shown above, wherever a Modulation Source is selected, the number value immediately to its right controls the Modulation Amount; this number determines how deeply the selected modulator will affect the manual level to which it is being applied.

Select the number to the right of the Modulation Source. Now, use the **Data Entry Controls** to adjust the modulation amount. Modulation amount can be positive or negative. A modulation amount of +00 has the effect of turning the modulator off.

Tip: With modulation amount, as with all parameter values that have a center value (here, +00), there is an easy way to reach that value. With the parameter selected, press the {[] } button, and while holding it down, press the {[] } button, and then quickly release both buttons. This automatically sets the modulation amount to +00.

Specifying a Modulation Source

Use the {CURSOR} buttons to select the Modulation Source parameter. Remember, it will be flashing in the display when it is selected. Now you can use the **Data Entry Slider** or the {VALUE} buttons to select one of the 16 available Modulation Sources:

LFO - Low Frequency Oscillator	PITCH - Pitch Bend Wheel
NOISE1 - Stepped Noise Generator	PEDAL - Control Voltage (CV) Pedal
NOISE2 - Smooth Noise Generator	TIMBRE - Timbre (sequencer only)
ENV1 - Envelope 1	XCTRL - External MIDI Controller
ENV2 - Envelope 2	PRESSR - Pressure (Aftertouch)
ENV3 - Envelope 3	KEYBD - Keyboard Tracking
WHL+PR - Mod Wheel + Pressure	VELOC - Velocity
WHEEL - Modulation Wheel	<OFF> - No modulation

LFO — Low Frequency Oscillator

The Low Frequency Oscillator generates only very low frequency waves, below the audio spectrum, which can produce vibrato, tremolo, and many other effects depending on the LFO wave selected and where it is applied as a modulator. There are seven possible waveshapes for the LFO.

LFO is permanently routed to the waveform generator for pitch modulation. It can also be assigned as a modulator elsewhere. See the description of the LFO pages in *Section 6 — Standard Sound Parameters* for a complete discussion of the LFO.

NOISE1 — Stepped Noise Generator

The noise generator creates a randomly changing level. It is useful for modulating, among other things, the pitch of a voice (Pitch Modulation page). Applied to pitch with large modulation amounts, it tends to create strange “computer” sound effects. Small modulation amounts (around +02 to +04) can create a subtle random movement in the sound, which imparts a more natural quality. Depends on the Noise Rate setting, on LFO page 30.

NOISE2 — Smooth Noise Generator

The second noise generator works like NOISE1, but NOISE2 has a “smoothed” wave pattern. When applied to pitch, NOISE2 has a “siren-like” quality, as compared to NOISE1’s computer effects. Notice the difference between the two noise generator wave shapes:

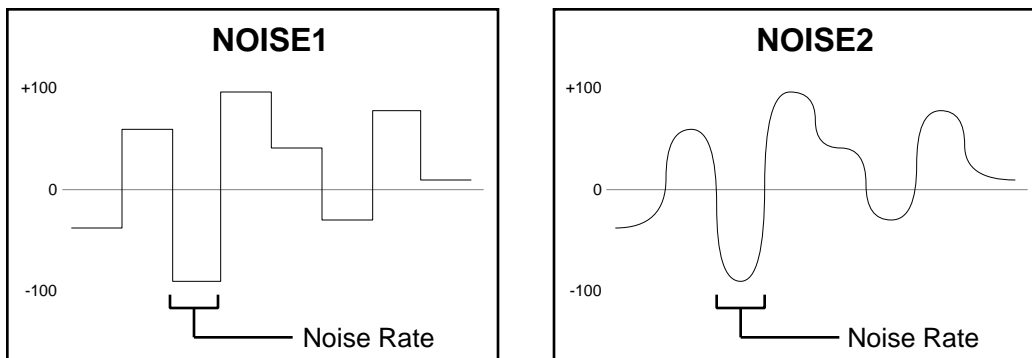

ENV 1, ENV 2, ENV 3

The KT has three complex envelopes. Envelopes are used to create changes over time, in pitch, brightness, volume, etc.

- ENV 1 is permanently routed to the pitch of the voice, though it can be assigned as a modulator elsewhere if you wish.
- ENV 2 is permanently routed to the filter cutoff frequency. It can also be assigned as a modulator elsewhere.
- ENV 3 always controls the volume or amplitude of the voice. It can also be selected as a modulator elsewhere.

WHL+PR — Modulation Wheel and Pressure

This dual modulation source allows both Pressure and the Mod Wheel to simultaneously modulate the same destination. When selected, pressing down on a key or moving the Mod Wheel yields the same result.

WHEEL — Modulation Wheel

The Mod Wheel to the left of the keyboard is assignable wherever a modulator is selected. To use the Mod Wheel for vibrato (one common application) WHEEL must be assigned to modulate the LFO, with the LFO Amount set to some number other than +00 on Pitch Mod page 1. The Mod Wheel's effect is positive, from 0 (wheel toward you) to +99 (wheel away from you). Negative modulation amounts will reverse the effect.

PITCH — Pitch Bend Wheel

This assigns the Pitch Wheel, located to the left of the Mod Wheel, as a modulator. It allows you to have the Pitch Wheel, besides bending the pitch of a note (its normal function), also affect another parameter. Applied to the filter cutoff frequency, for example, this would cause notes to become brighter as you bend them upwards and more muted as you bend them down (or the opposite with negative modulation amounts).

PEDAL — Voltage Control (CV) Pedal

This selects the optional CVP-1 Foot Pedal, which can be plugged into the CV•Pedal jack on the KT rear panel, as a modulator. It can be applied wherever a modulator is selected. Note that the CV pedal will only act as a modulator when the pedal function on System•MIDI page 3 is set to “CV-Pedal=MOD #4.” When that parameter is set to “CV-Pedal=VOL #7” the CV pedal will act as a volume pedal, not as a modulator (though this has no effect on receiving incoming MIDI pedal data). See *Section 2 — System•MIDI Parameters* for more details.

TIMBRE — Timbre Control

This is a special modulator, unique to ENSONIQ, which is intended as an “extra” real-time performance controller. TIMBRE can be assigned like any other modulator, wherever a modulation source is selected. The Timbre parameter on Edit Track page 8 selects the TIMBRE amount. With the Timbre parameter selected, you can use the **Data Entry Slider** to control the modulator.

XCTRL — External MIDI Controller (MIDI In only)

An external controller (such as a Breath Controller, etc.) that is received via MIDI from another synthesizer or controller, can be assigned as a modulator within KT sounds. In System•MIDI mode, you can select the number of the external controller that will be recognized by the KT.

You don't have to be playing the KT from an external instrument for this to work. For example, if you have a keyboard with a MIDI Breath Controller:

1. Connect its MIDI Out to the KT MIDI In;
2. Make sure both instruments have Controllers enabled (in the KT, {SYSTEM"MIDI} page {7});
3. Select Breath Controller as the external controller that will be received by the KT (XCtrl=002, on {SYSTEM"MIDI} page {6});
4. Assign XCTRL as a Modulator for LFO level, Filter Cutoff frequency, or some other manual level within a voice, as described in the Standard Sound Parameters section; and
5. Play the sound from the KT keyboard, while blowing into the Breath Controller connected to the sending instrument. The modulation will have the same effect as if you were playing from the sending instrument.

PRESSR — Pressure (After-touch)

Pressure, also called after-touch, is a modulator that varies a manual level within a voice depending on how hard you press down on a key or keys.

When playing the KT keyboard, after you have struck a key, and while the note is sustaining, continuing to press down harder on the key brings in the pressure modulation.

Pressure comes in two varieties — Poly-Key™ pressure (or Polyphonic pressure), which affects each note individually, and Channel pressure (or Mono pressure) which affects all notes that are playing when you exert pressure on any key. Both types are received via MIDI on the KT, however, the KT keyboard can only generate channel pressure.

Not all sounds are programmed to respond to pressure (like piano sounds). If pressure seems to have no effect when you play certain sounds, it is likely that pressure is not assigned as a modulator anywhere within the sound.

The effect of pressure as a modulator is positive-going only, though assigning a negative modulation depth will cause increased pressure to reduce manual levels.

KEYBD — Keyboard Tracking

This uses the position of a note on the keyboard as a modulator:

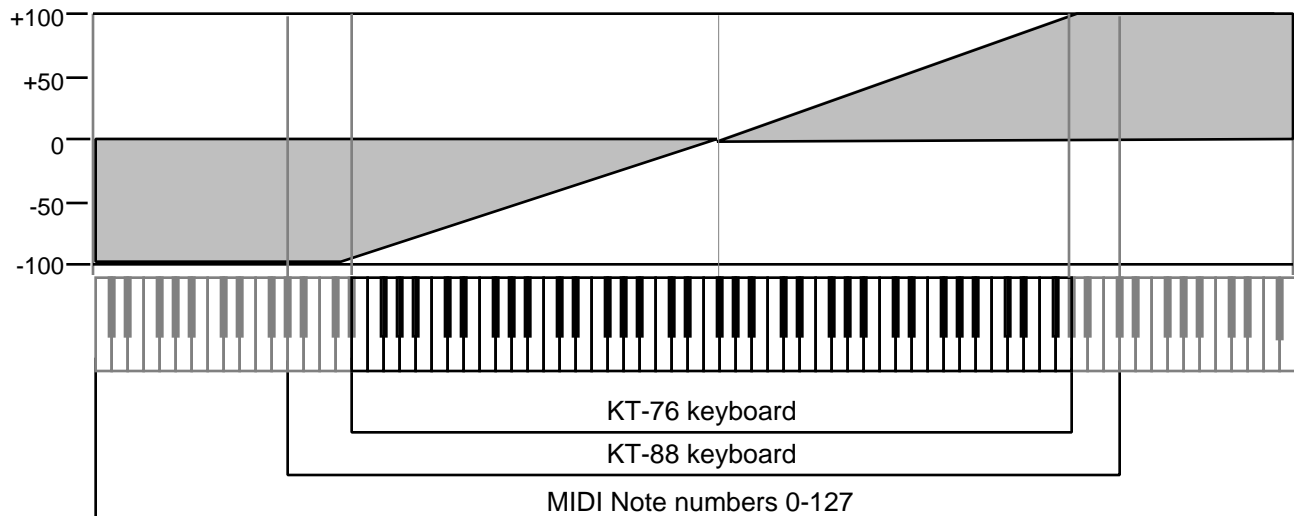

As the above illustration shows, the effect of KEYBD as a modulator goes negative as well as positive. The effect of KEYBD is to reduce the manual level on notes below the break point (F# above Middle C, F4+, MIDI Note #66), and increase the manual level on notes above the break point. Negative modulation amounts will do the opposite.

VELOC — Velocity

Velocity means how hard you strike a key. Selecting VELOC as a Modulator allows you to modulate any manual level with velocity. Velocity as a modulation source only goes positive (though assigning a negative modulation amount will make the level reduce with increased velocity).

ENV 1, ENV 2, ENV 3 — KT Standard Sound Envelopes

An envelope is a shape, or contour, which we apply to a signal to make it change over time. Each KT voice has three envelopes. These envelopes are automatically routed to the pitch, filter frequency, and amplitude of the voice. ENV 1, ENV 2 and ENV3 can also be assigned elsewhere, wherever a modulator is selectable.

- ENV 1 is routed to the pitch of the voice. There is a parameter always available on Edit Sound page 11 (press {EDIT_SOUND}, the upper {1}, then the lower {1}) that lets you adjust the amount by which ENV 1 will modulate the voice's pitch.
- ENV 2 is routed to the filter cutoff frequency of the voice. For each of the voice's two filters, the parameter labeled Envelope 2=+## on Edit Sound page 41 (press {EDIT_SOUND}, the upper {4}, then the lower {1}) controls ENV 2 depth.
- ENV 3 is routed to the amplitude (volume) of the voice. The ENV 3 envelope always controls the final volume contour of the voice. Any other volume modulators selected in the Output pages will occur before ENV 3 in the signal flow.

The KT envelopes are descended from the venerable ADSR (attack, decay, sustain, release) envelope, but with many refinements. While the ADSR envelope gives you control over three time segments and one level, the KT envelopes give you control over three levels and four time segments.

The illustration below shows the make-up of a KT envelope:

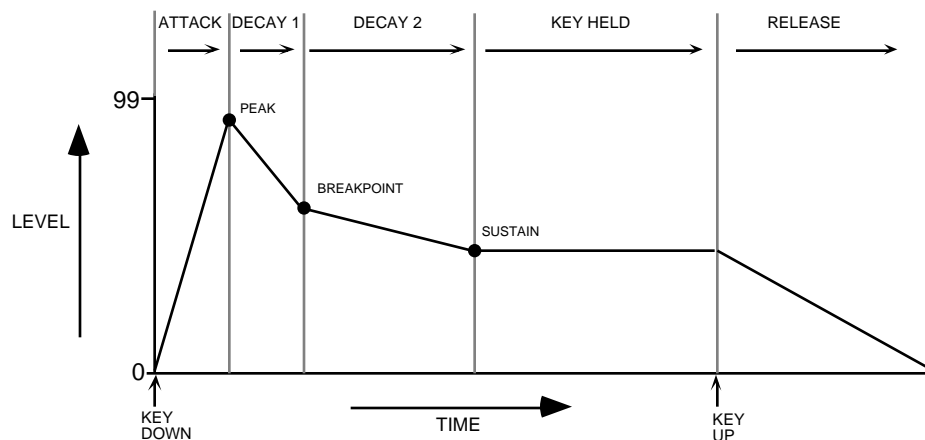

Although the envelope shape in the above illustration is the most commonly used (a rise followed by decays), other shapes are possible. For more information on the specific envelope parameters, see *Section 6 — Standard Sound Parameters*.

Section 6 — Standard Sound Parameters

This section covers the parameters that can be edited independently for each voice within a Standard Sound. For a general overview of the concepts involved, refer to the previous section.

Edit (Standard) Sound Mode

Whenever you want to do any editing to a Standard Sound, you must first place the KT into Edit (Standard) Sound mode. Once in Edit (Standard) Sound mode, you can modify parameters of a Standard Sound to better suit your needs or create a completely new sound.

To access the following parameters, first select a Standard Sound, and then press the {EDIT_SOUND} button to enter Edit Sound mode. In Edit Sound mode, the upper {0} to {9} buttons are used to access the groups of pages relating to sound editing, and the lower {0} to {9} buttons are used to select the pages within that group. This combination of upper and lower buttons is called the page number. Each page in Edit Sound mode has a two digit page number.

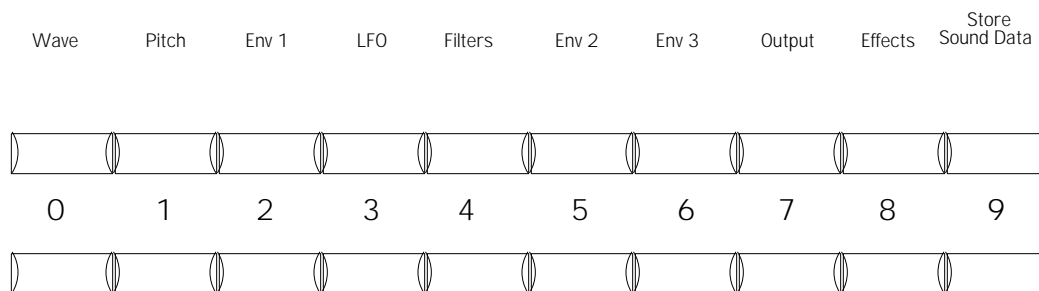

Wave Pages (00 - 05)

Each KT voice will play one of the 211 waves in its memory. These waves are the “raw material” from which KT sounds are crafted. In the Wave pages you can choose which wave the currently selected voice will play, and modify various playback parameters of the wave.

Edit Sound

page 00

EditVOICE/Voice Status

Selected Voice

m

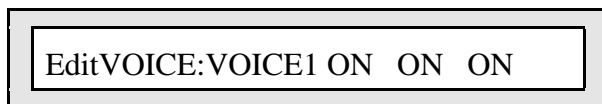

p i j
Voice Status Values

EditVOICE

Range: VOICE1-3 or ALL

This parameter has three functions; to select whether to edit one voice or all voices within a sound; to select which voice will be edited (if one voice is selected); and to determine the playback status of that voice.

To select a single voice for editing:

1. Press {EDIT_SOUND}.
2. Press the upper {0} button, then the lower {0} button to get to page 00.
You will see the EditVOICE/Voice Status page shown above. If the Selected Voice value (top of the display) is not flashing, press the {<} button once.
3. Use the **Data Entry Slider** or the {VALUE} buttons to set “EditVOICE:VOICE1, 2, or 3”.

To select all voices for editing:

1. Press {EDIT_SOUND}.
2. Press the upper {0} button, then the lower {0} button to get to page 00.
You will see the EditVOICE/Voice Status page. If the Selected Voice value (top of the display) is not flashing, press the {<} button once.
3. Use the **Data Entry Slider** or the {VALUE} buttons to set “EditVOICE:ALL”.
When “ALL” is selected, changes made to any of the programming parameters will affect all voices playing within that sound. If you use the {VALUE} buttons to edit a parameter with EditVOICE=ALL, the settings for each voice will change relative to one another, rather than to the exact value displayed. Using the **Data Entry Slider** will set all voices the same value.

Voice Status

Range: OFF, ON, or SOLO

These parameters are used to determine which voice(s) will play and/or be edited. These values correspond to the three voices that make up a KT sound.

A voice is selected for editing by setting the EditVOICE parameter to that voice, then pressing the {>} button to select the voice status value and setting it to either ON or SOLO. When the voice is selected (EditVOICE:VOICE1-3), the corresponding Voice Status value will begin flashing. From that point, any editing you do will affect that particular voice. If the voice you wish to edit is set to “OFF,” you will be unable to edit any parameters for that voice, and the display will momentarily show “Sorry current voice is muted.”

There are three status options that a voice can be set to on this page:

- OFF — The selected voice is muted, will not play, and cannot be selected.
- ON — The selected voice will play, and can be selected.
- SOLO — The selected voice will play and can be selected, and all other voices will be muted. This is convenient for occasions when you’d like to hear how your edits are affecting a particular voice.

☞ **Remember:** The Voice Status value that is flashing is the one that is selected for editing.

Wave Class/Wave Name

Wave Class

m

Wave=STRING WAVE STRING
ENSEMBLE

i

Wave Name

Wave Class

Range: Various (see below)

This shows which of the 14 wave classes the currently selected wave is in. By selecting this parameter, you can use the **Data Entry Slider** or the {VALUE} buttons to scroll quickly through the different wave classes to the category you want. Then select the wave name on the lower line to choose a specific wave from the current class.

Whenever the wave class is changed, the first wave in that class is selected.

The KT waves are divided into 14 categories, or *Wave Classes*:

KEYBOARD STRING-SND BRASS+HORNS WIND+REEDS VOCAL-SOUND BASS-SOUND DRUM-SOUND	CYMBALS PERCUSSION TUNED-PERCUS SOUNDEFFECT WAVEFORM INHARMONIC TRANSWAVE
---	--

The first eleven wave classes contain samples of real acoustic and electronic sounds, which can be used as the basis for a wide variety of realistic musical sounds. Where necessary, these waves have been *multi-sampled* (sampled at many points through the range of the instrument) for maximum accuracy.

The next three wave classes contain a variety of sampled and algorithmically generated waves that are more “synthesizer” oriented:

- **WAVEFORM** - A waveform is a single cycle of a sound repeated over and over. The KT contains both sampled and synthetic waveforms. Waveforms such as Sawtooth and Square can be used to reproduce a wide array of analog synth sounds.
- **INHARMONIC** - Inharmonic loops are similar to waveforms except that they contain many cycles of the sound and can therefore contain *inharmonics* — frequencies which are not exact multiples of the fundamental frequency.
- **TRANSWAVE** - This is a special class of waves. Each TransWave consists of many single-cycle waveforms, each with a different harmonic spectrum. The playback parameters allow you to start the wave playing at any one of these waveforms and move through the wavetable, continually varying the timbre of the sound, using any of the modulators.

Wave Name

Here you select the actual wave that the voice will play. When this parameter is flashing, the **Data Entry Slider** and the {VALUE} buttons will select only among the waves in the current wave class.

KT Standard Sound ROM Wave Catalog

The Wave Class is shown in bold at the top of each ROM wave group:

KEYBOARD: CONCERT GRAND BRIGHT GRAND PIANO THUD TINE PIANO LO TINE PIANO MED TINE PIANO HI DIGITAL EL PIANO FM ELEC PIANO ELEC PIANO TINE WURLIE HI VEL WURLI LO VEL CLAVINET HARPSICHORD CELESTE PERC ORGAN 1 PERC ORGAN 2 ROTARY ORGAN PAD SYNTH PIPE ORGAN	WIND+REEDS: SOPRANO SAX ALTO SAX TENOR SAX SAX AIR CLARINET BASSOON OBOE FLUTE CHIFFLUTE PAN FLUTE OCARINA RECORDER ACCORDION HARMONICA VOCAL-SOUND: CHOIR VOCAL AAH VOCAL OOH DOO ATTACK	DRUM-SOUND: PUNCHY KICK ACOUSTIC KICK FAT KICK GATED KICK AMBIENT KICK SYNTH KICK ROOM KICK BRIGHT KICK DRY KICK JAZZ KICK 1 JAZZ KICK 2 ELEC KICK LOOP KICK DANCE KICK REAL SNARE ROCK SNARE GM SNARE 1 GM SNARE 2 GATED SNARE PUNCHY SNARE CONCERT SNARE DANCE SNARE ELEC SNARE HIP HOP SNARE SYNTH SNARE RIMSHOT SIDESTICK 1 SIDESTICK 2 STICK CLICK SYNTH RIM SNARE ROLL BRUSH SLAP BRUSH SWISH BRUSH HIT BRUSH TAP BRUSH TOM DRY TOM ROOM TOM SYNTH DRUM	CYMBALS: CLOSED HAT 1 CLOSED HAT 2 OPEN HAT 1 OPEN HAT 2 PEDAL HAT CRASH CYMBAL CHINA CRASH RIDE CYMBAL RIDE BELL SYN CLOSEHAT SYN OPEN HAT PERCUSSION: CONGA MUTE CONGA HIGH CONGA LOW TIMBALI BONGO TAIKO SHAKER CABASA MARACAS WOODBLOCK CLAVE GUIRO CUICA VIBRASLAP COWBELL AGOGO TAMBOURINE TRIANGLE SLEIGHBELL FINGER SNAPS WHISTLE SYNTH KISS SYNTH CLAPS SYNTH CLAVE SYNTH COWBELL SYNTH MARACAS CASTANETS	TUNED-PERCUS: VIBRAPHONE MARIMBA XYLOPHONE GLOCKENSPIEL TYMPANI STEEL DRUM KALIMBA DOORBELL TUBULAR GAMELAN BELL ORCHESTRA HIT DANCE HIT SOUND-EFFECT: BIRD SONG APPLAUSE TELEPHONE GUNSHOT WINDCHIME WAVEFORM: SINE WAVE SAWTOOTH WAVE SQUARE WAVE TRIANGLE WAVE CHURCH ORGAN ORGAN WAVE 1 ORGAN WAVE 2 ORGAN WAVE 3 REED ORGAN BELL WAVE 1 BELL WAVE 2 BELL WAVE 3 BELL WAVE 4 DOUBLE REED SINGLE REED ANALOG WAVE 1 ANALOG WAVE 2 ANALOG WAVE 3 ANALOG WAVE 4 ANALOG WAVE 5 ANALOG WAVE 6 DIGITAL WAVE 1 DIGITAL WAVE 2 SYNKEY WAVE VOCAL WAVE
STRING-SND: ORCH STRINGS VIOLIN CELLO PIZZ STRINGS HARP NYLON GUITAR STEEL GUITAR FRET NOISE ELEC GUITAR 1 ELEC GUITAR 2 JAZZ GUITAR MUTE GUITAR DISTORTED GUITAR GUITAR HARMONIC BANJO GOTO SHAMISEN SITAR	BASS-SOUND: FINGER BASS SMOOTH BASS WOODY BASS PICKED BASS SLAP BASS FRETLESS BASS MUTED BASS BASS HARMONICS ELEC BASS TAP ACOUSTIC BASS ANALOG BASS 1 ANALOG BASS 2 ANALOG BASS 3 ANALOG BASS 4 ANALOG BASS 5 FM SYNTH BASS TRANSWAVE: BELL XWAVE 1 BELL XWAVE 2 RESONANCE TRANSWAVE EE TRANSWAVE AY TRANSWAVE AA TRANSWAVE OH TRANSWAVE-Z	INHARMONIC: BIG BELL CRYSTAL SYNTH BELL NOISE AIR LOOP SPECTRUM		
BRASS+HORNS: TRUMPET FLUGELHORN MUTED TRUMPET TROMBONE SOLO FRENCH HORN FRENCH HORN SECT BRASS SECTION				

Edit Sound

page 02

Delay Time/Direction

```

Delay Time=000
Direction=FORWRD

```

Delay Time

Range: 000 to 250 msec, or KEYUP

Determines how long the voice will wait after a key is struck before playing. A delay of up to 250 milliseconds is possible.

When Delay Time=KEYUP, the voice will wait until the key is released before it plays.

Direction

Range: FORWRD or BACKWD

This parameter determines the direction a wave will play. When Direction=BACKWD, looped sounds will play from the end of the sample to the start point, and will not loop.

Edit Sound

page 03

Start Index/ModSource/Mod Amount

```

Start Index=00
Mod=VELOC * +000

```

i

Mod Source

i

Mod Amount

Start Index

Range: 00 to 99

This parameter is an alternate wave start point that can be dynamically switched to (controlled by the Mod Source and Amount parameters). When START=00, the whole wave will play. As the start point is adjusted upwards, it will begin playing further into the wave. You can use this, for example, to skip the attack and play only the loop portion of (looped) sustaining sounds.

A note about TransWaves

Each TransWave is actually composed of many different single-cycle waveforms, which progress from one timbre to another, occupying adjacent areas of memory. Movement within the sound is created by playing different waveforms in succession; that is, by modulating the wavetable.

When Wave=TRANSWAVE on the previous page, the Start Index parameter controls where within the wavetable the voice-loop will begin playing when the key is struck. The illustration below shows a typical wave of this category, with the Start Index set in the middle range, near 50.

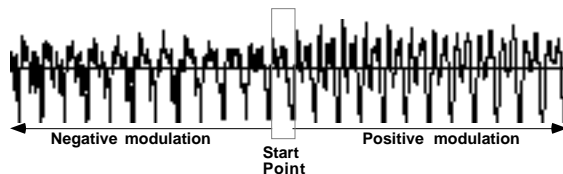

Mod Source Range: Various

Here you can choose which of the modulators will be used to modulate the Start Index. When Mod=<OFF> and the Mod Amount is +000 or lower, the wave always starts playing from the Start Index. If Mod=<OFF> and the Mod Amount is +001 or higher, the wave will always start playing from the beginning, and ignore the Start Index.

When Wave=TRANSWAVE on the previous page, the Mod Source parameter chooses which of the 15 modulators will control the movement of the sound. Any of the modulators can be selected.

Mod Amount Range: -127 to +127

Determines how much the selected modulation source (above) will affect the wave: i.e. how far away from the start point the sound will move. This parameter acts as the Start Index threshold: With Mod Amounts set to +001 or higher, if the modulator output exceeds the Mod Amount, the wave plays from the Start Index. With Mod Amounts set to +001 or higher, if the modulator output is lower than the Mod Amount, the wave plays from the beginning. Negative mod amounts produce the opposite effect. If the mod amount is set to +000, the sound will remain static, always playing from the Start Index.

When Wave=TRANSWAVE on the previous page, the Mod Amount parameter determines how much the selected modulator (above) will affect the wave; i.e. how far away from the start point the sound will move. If Mod Amount is set to +000, the sound will remain static. Positive amounts will modulate the sound forward (toward the end of the wave); negative modulation amounts will move the sound back toward the beginning.

Edit Sound

page 04

Sample Shift/Mode

Sample Shift=+00
Mode=SHIFT ALL

Sample Shift Range: -60 to +60

Changes keyboard split points on multi-sampled waves in two ways, according to the Mode parameter. This has the effect of setting the multi-samples to ranges you wouldn't otherwise hear (allowing aliasing in some cases), creating completely different colorations. A setting of +00 is the setting for normal multi-sample playback.

Mode Range: SHIFT ALL or STRETCH ONE

This parameter determines how the multi-sampled waves will shift.

- When Mode=SHIFT ALL, all multi-sample split points will be shifted up or down the keyboard by the number of semitones specified by the Sample Shift parameter. This is the setting for normal multi-sample playback.
- When Mode=STRETCH ONE, the Sample Shift value selects a key, relative to C4 (i.e., +02=D4), whose sample will be played on all keys below it, overriding the normal multi-sample key map. Keys above the selected key will play their multi-samples as normal. The same key's sample will be stretched regardless of the Pitch page 10 Oct/Semi settings.

Voice Restrike Decay Time

Voice Restrike
Decay Time = 3

Voice Restrike Decay Time Range: 0 to 7

This parameter controls the voice Restrike time. When you play a particular note and then strike it again immediately before the old note has finished sounding, the amount of time it takes for the first strike to fadeout is determined by this parameter. By varying the setting of this parameter, you can control how long sounds overlap when a note is restruck.

For example, if you have a slow string sound, it may sound more natural to use a longer restrike value, which will cause the old note to decay more slowly, rather than end abruptly when the new note starts. Normal values are around 3. The higher the value, the longer the fadeout time.

Tip: If you hear clicking sounds when you restrike a note, setting the Restrike time to higher values may eliminate the click.

```
SoundFinder
Type=ACPIANOS
```

SoundFinder Type

Range: various (see below)

Allows you to define a sound class for your sounds for use with ENSONIQ's exclusive SoundFinder™ feature. This setting can also be used by third-party editor librarian software for “automatic-sorting” of sounds by type. The available types are:

- ACPIANOS Acoustic pianos, honky-tonk, toy pianos, and piano forte
- ELPIANOS Electric and electronic piano sounds
- ORGANS Pipe organs, electric, and electronic organs
- ALTKEYS Other keyboard sounds such as harpsichord, accordion, and piano layered with other sounds
- SYNLEAD Lead synth sounds
- SYNPAD Sustaining synth pads
- VINTGSYN Vintage synth sounds
- SYNOTHER Other synth sounds: hybrids, fat power-synths
- GUITARS Acoustic guitars, clean electric guitars and distortion guitars
- ALTPLUCK Other plucked strings: harps, banjo, dulcimer, sitar, etc.
- SOLOSTRG Plucked and bowed solo strings (violin, viola, cello, bass)
- STRGSECT Plucked and bowed string sections and small ensembles
- SOLOBRAS Solo brass: trumpet, trombone, tuba, French horns
- BRASSECT Brass sections: trumpet, trombone, tuba, French horns
- SOLOSAX Solo saxophones
- SOLOWIND Solo woodwinds/reeds (including harmonica)
- WINDSECT Woodwind/reed/saxophone sections and small ensembles
- VOCALS Vocal sounds: choirs and synth-vox
- ACOUBASS Acoustic basses
- ELECBASS Electric basses
- SYNBASS Synth basses
- PERCUSSN Percussion kits and solo untuned percussion (e.g. taiko)
- TUNEPERC Tuned percussion, orchestral hits
- MALLET Tuned mallet-struck instruments: marimba, xylophone, tympani
- BELL Acoustic and synth bell sounds
- SOUND-FX Realistic (e.g. broken glass) and fantasy (e.g. spacecraft) sound effects
- HYBRDLYR This is for unnatural stacked/layered combinations of acoustic elements (e.g. a bass harmonic on top of a string section).
- SPLITS Combination keyboard splits of 2 or more different sounds
- UTILITY Utility resources such as default template sounds
- OTHER Unclassified miscellaneous sounds (e.g. didgeridoo)
- CUSTOM Use this to define your own special purpose sound type: ENSONIQ sounds will never be released with TYPE=CUSTOM.

For more information on using SoundFinder, see *Section 1 — Controls & Architecture*.

Change Sound Mode

Press ENTER to
Change SoundMode

Change Sound Mode

Range: Standard or Drum Sounds

This command allows you to switch the current sound mode between Standard Sounds and Drum Sounds. When working in Edit (Standard) Sound mode, this command will place the default Drum Sound into the edit buffer and place the KT in Edit (Drum) Sound mode.

To Change the Current Sound Mode:

- Press {ENTER}. The display momentarily shows “Command Successful!” changes between modes, and then displays Edit Sound page 00.

Pitch Pages (10 - 13)

The Pitch pages determine the “manual” levels for the pitch of the voice, as well as the poly/mono voice assignment mode.

Edit Sound

page 10 **Oct/Semi/Fine**

Oct=+0 Semi= +00 Fine= +00

Oct Range: -4 to +4 octaves

Changes the pitch of the voice by octaves.

Semi Range: +11 to -11 semitones

Changes the pitch of the voice by semitones. Incrementing/decrementing this control beyond +11 or -11 automatically increases/decreases the octave by one.

Fine Range: -99 to +99

Fine-tunes the pitch of the voice by steps of one cent (1/100 of a semitone).

Edit Sound

page 11 **Env1/LFO/Mod**

On this page, you can apply modulation to the pitch of the voice. Envelope 1 and the LFO are always available to modify the pitch, and you can also choose one additional modulator from the available Modulation Sources.

Env1=+00 LFO=+10 Mod=NOISE1 *
+00

i

Mod Source

i

Mod Amount

Env1 Range: -99 to +99

This hard-wired modulation routing determines the amount that Envelope 1 will affect pitch. Unlike applying ENV 1 as a pitch modulator with the Mod Source parameter, the hard-wired Env 1 parameter forces Envelope 1 to always sustain at the normal pitch setting (found by pressing {EDIT_SOUND}, the upper {1}, then the lower {0} button). The Envelope 1 SUSTAIN level (level 3) no longer controls the pitch at which Envelope 1 will sustain. Instead, it becomes an “equator-shift” value, determining which Envelope 1 level values will cause the pitch to rise above the manual pitch setting and which level values will drive it below. Envelope 1 level values equal to the SUSTAIN level (level 3) value will sound at the manual setting. Higher level values will shift the pitch upward from the normal pitch setting, and lower values will shift the pitch downward. This feature allows for the creation of bi-directional pitch envelope shapes, while conveniently ensuring that voices will always sustain at the normal pitch setting (eliminating the need to offset the pitch setting for different envelope shapes).

LFO Range: -99 to +99

Determines the amount that the LFO (Low Frequency Oscillator) will affect the pitch of the voice. The LFO is most commonly used for vibrato, but it can create many unusual effects, depending on the LFO waveform chosen.

Mod Source Range: Various

Selects an additional modulator for the pitch of the voice from among the available modulation sources.

Mod Amount Range: -99 to +99

Determines the amount or depth by which the additional modulation source will affect pitch.

Edit Sound

page 12

Keyboard Pitch Tracking

Keyboard Pitch Tracking = ON

Keyboard Pitch Tracking Range: OFF or ON

Determines whether or not the pitch of the selected voice will change across the keyboard, or remain static:

- ON — The pitch of a voice tracks with the keyboard.
- OFF — All keys play at the same pitch (C4 if the Oct/Semi/Fine parameters have not been edited). If the Oct/Semi/Fine parameters have been edited, the wave's pitch will be transposed by the amount set on that page.

Glide= NONE Glide Time = 00

Glide

Range: NONE, TRIGGER, MINIMODE, or LEGATO

Enables Glide (portamento) and several forms of monophonic voice assignment in a sound. All three voices in a sound share the same Glide time, but each voice selects whether it will glide or not. There are four Glide settings:

- **NONE** — Glide is off. Use this for normal polyphonic operation, with no portamento.
- **TRIGGER** — This mode plays monophonically. The envelopes and waves are *always* retriggered, or restarted from the beginning, each time there is a new key down. If a key is depressed before another is released (i.e. if you play legato), the voice will glide from the old note to the new one. If you play a key with no other keys down (i.e. if you play staccato), the voice will not glide. This mode does not feature note memory (see below). This is ideal for adding monophonic piano “thuds” to piano sounds.
- **MINIMODE** — This mode also plays monophonically. Unlike TRIGGER mode, the envelopes and waves are only restarted from the beginning when you play a key with no other keys down (i.e. if you play staccato). If a key is depressed before another is released (i.e. if you play legato), the voice will glide from the old note to the new one. If you play a key with no other keys down (i.e. if you play staccato), the voice will not glide. This is ideal for vintage synth or synth bass sounds.
- **LEGATO** — Again this mode also plays monophonically. The envelopes and waves are *always* retriggered, or restarted from the beginning, each time there is a new key down. If a key is depressed before another is released (i.e. if you play legato), the voice will glide from the old note to the new one. If you play a key with no other keys down (i.e. if you play staccato), the voice will not glide. This is ideal for performing trills on wind instruments, such as flutes.

Note: MINIMODE and LEGATO feature “note memory.” If you release a key while still holding down another key, the pitch will glide back to the note you are holding. Holding down the sustain pedal will dynamically disable note memory.

GLIDE MODES

MODE	Staccato Glide	Legato Glide	Legato Envelope/Wave Retrigger	Note Memory
NONE	NO	NO	NO	NO
TRIGGER	NO	YES	YES	NO
MINIMODE	NO	YES	NO	YES
LEGATO	NO	YES	YES	YES

Glide Time

Range: 00 to 99

Determines the amount of time that it takes for the pitch to glide smoothly from one note to another. The higher the value, the longer the glide time. Unlike the Glide parameter, Glide Time controls all three voices within the sound. The KT uses *Constant-Time Portamento*. This means that it will take the same amount of time to glide between notes that are close together (e.g. C4 to D4) as it will to glide between notes that are far apart (e.g. C4 to C7).

Env 1, Env 2 And Env 3 Pages

The Env 1, Env 2, and Env 3 pages, parameters, and ranges identical except where indicated below. Envelope 1 parameters are found on KT page locations 20-23, Envelope 2 are found on pages 50-53, and Envelope 3 are found on pages 60-63. We will use Envelope 1 as our example.

Edit Sound

page 20

Levels/Time

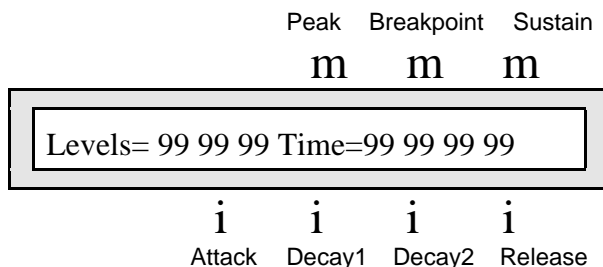

Levels

Ranges: 00 to 99

This parameter sets the levels for the three stages of the envelope. These values correspond to the following levels:

PEAK

Determines the level the envelope will reach at the end of the time defined by ATTACK (see below).

BREAKPOINT

Determines the level the envelope will reach at the end of DECAY 1.

SUSTAIN

Determines the level the envelope will reach at the end of DECAY 2 and will retain as long as the key is held down.

Time

Range: 00 to 99

This is used to set values for the four time segments. Note that the numbers shown here represent times, not rates. That is, the envelope will take a fixed amount of time to go from one level to another, no matter how far apart those two levels are. See the following Envelope Times chart for a listing of the time values.

ATTACK

The amount of time it takes for the envelope level to travel from when the key is struck to the PEAK level. The higher the value, the longer the time.

Note: This doesn't necessarily have to be an "attack" in the usual sense. If the ATTACK time is set to 00, the PEAK level becomes the "initial" level of the envelope. If the PEAK level is set higher than the BREAK level, this would function as another decay stage.

DECAY 1

The time it takes the envelope to go from PEAK to BREAKPOINT.

DECAY 2

The time it takes the envelope to go from BREAKPOINT to SUSTAIN.

RELEASE

This defines the time it will take the envelope to return to zero from whatever level it has attained when the key is released.

Envelope 1 and 2 Times

value	time (in sec)	value	time (in sec)	value	time (in sec)	value	time (in sec)	value	time (in sec)
00	.00	20	.20	40	.82	60	3.2	80	13
01	.01	21	.22	41	.88	61	3.5	81	14
02	.02	22	.23	42	.94	62	3.7	82	15
03	.03	23	.25	43	1.0	63	4.0	83	16
04	.04	24	.27	44	1.0	64	4.3	84	17
05	.06	25	.29	45	1.1	65	4.6	85	18
06	.07	26	.31	46	1.2	66	4.9	86	19
07	.08	27	.33	47	1.3	67	5.3	87	21
08	.08	28	.35	48	1.4	68	5.7	88	22
09	.09	29	.38	49	1.5	69	6.1	89	24
10	.10	30	.41	50	1.6	70	6.5	90	26
11	.11	31	.44	51	1.7	71	7.0	91	28
12	.11	32	.47	52	1.8	72	7.5	92	30
13	.12	33	.50	53	2.0	73	8.1	93	32
14	.13	34	.54	54	2.1	74	8.6	94	34
15	.14	35	.58	55	2.3	75	9.3	95	37
16	.15	36	.62	56	2.4	76	9.9	96	39
17	.16	37	.66	57	2.6	77	10	97	42
18	.17	38	.71	58	2.8	78	11	98	45
19	.19	39	.76	59	3.0	79	12	99	49

Note that the Envelope 3 time levels are shorter. The envelope time for a value of 16 is identical to the 01 value in the chart (i.e. value 16 = .01 sec). All values higher than 16 follow the chart in ascending order based on this interval. Values less than 16 can be used to eliminate the “click” attack on waves and still give the appearance of an instant attack.

Edit Sound

page 21

LevV/AtckV/VelCurv**LevV**

Range: 00 to 99

The Velocity Level parameter will lower all envelope settings with a softer keystrike. This means that the settings you assign to PEAK, BREAK, and SUSTAIN are the maximum levels that will be reached with the hardest keystrike. The amount of “LevV” will determine how much those levels will be reduced as you play softer. With this parameter you can have continuous dynamic control over the three levels by varying how hard you play. Changing the Velocity Curve (VelCurv) gives you further control over the velocity response of the envelope.

AtckV

Range: 00 to 99

Velocity Attack makes the envelope ATTACK time respond to keyboard velocity. When the value of “AtckV” is increased, a harder keystrike will result in faster attack. Note that this parameter will have no effect if the envelope ATTACK Time=00.

VelCurv

Range: QUIKRISE, CONVEX, LINEAR, and CONCAVE

This selects which of the four available velocity response curves the envelope will use if the velocity level control (LevV above) is set to some value other than zero.

The graphs below are input/output curves, with the velocity on the x axis (left to right) and the corresponding output level shown on the y axis (up and down):

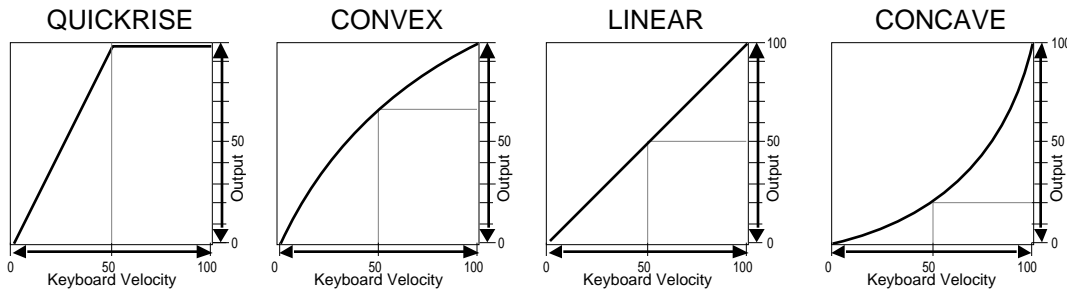

Edit Sound

page 22

Mode/KeyboardTrk

Mode = NORMAL KeyboardTrk = +00

Mode

Range: NORMAL, FINISH, or REPEAT

- **NORMAL** — The envelope plays through normally, as shown in the diagram on the following page. When the key is released, the envelope takes the RELEASE time to go from the current level down to zero.
- **FINISH** — The envelope runs its full cycle — finishes playing through all its stages — ignoring the key-up event. The envelope spends no time at the SUSTAIN stage. When the DECAY 2 time is finished, instead of stopping at the SUSTAIN stage, the envelope immediately goes into the RELEASE stage. This is good for percussive-type sounds where you want the envelope to be the same for every note, no matter how long the key is held down.
- **REPEAT** — In this mode, at the end of the DECAY 2 stage, instead of sustaining, the envelope goes immediately back to the beginning of the envelope and repeats, starting with the ATTACK stage gain. When the key is released, the envelope stops repeating and moves into the release stage, taking the RELEASE time to go from the current level down to zero. This type of envelope can be used to create complex LFO-type effects.

Mode (Env 3) — Voice Triggering

Since Env3 controls the volume of the voice, there are some special considerations to be aware of when using the different envelope modes:

- **NORMAL** — if you set a delay on the voice (press {EDIT_SOUND}, the upper {0}, then the lower {2}), and you release the key before the designated delay time elapses, the voice will not sound, even if the sustain pedal is down.
- **FINISH** — if you set a delay on the voice, and you release the key before the designated delay time elapses, the note will sound anyway. The envelope finishes what you set it up to do.
- **REPEAT** — the KT restarts the wave from the beginning every time the envelope repeats. At the end of the DECAY 2 time, the envelope goes back to the level when the key was struck. The envelope never stays at the sustain level.

Stealing Notes

To maximize the use of the KT's 64 voices, and to manage the "voice stealing," it is sometimes useful to understand when a given voice will be assigned and when it will be released, or "put back" into the pool for use by other sounds. This depends on a combination of envelope mode and wave type.

A (looped) sustaining wave will continue to use the voice until the envelope reaches zero. For a sustaining wave, when the envelope mode=NORMAL or REPEAT:

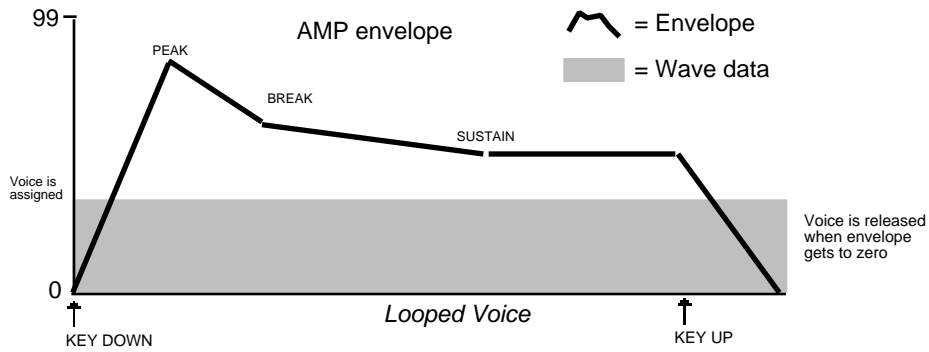

For a sustaining wave, when the envelope mode = FINISH:

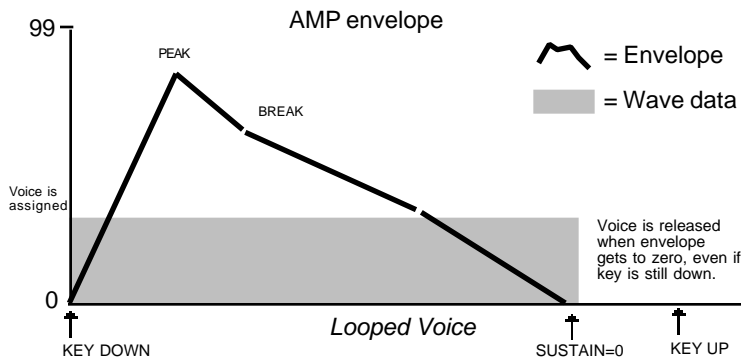

For unlooped, non-sustaining, waves (specifically those in the Percussion and Drum categories) the voice becomes free as soon as the sample has played through to the end, no matter where the envelope level is. The voice is released and is available for use by other sounds:

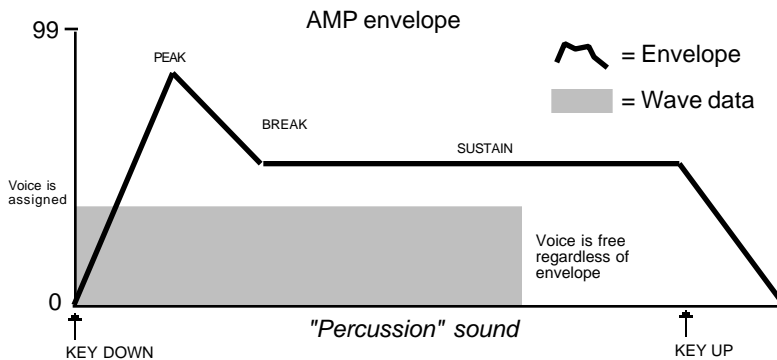

KeyboardTrk

Range: -98 to +98

Makes the envelope times longer or shorter, depending on the key played. The scaling effect of this parameter is based on a center break point of F4+.

Positive values will make all envelope times (except Release) shorter for keys above F4+, and longer for keys below F4+. Negative values will have the opposite effect. Envelope times for F4+ are not affected by this parameter.

Press ENTER to select defaults.



Press ENTER to Select Defaults.

Press ENTER to Select Defaults. Range: listed below

Pressing {ENTER} lists 39 available “preset” envelope values that can be placed into the current envelope.

To Select the Default Envelopes:

1. Press {ENTER}. The display shows:



Default Envelope
ENV1=ALL ZEROS

i

Currently selected envelope

p

Preset envelope values to be placed into the currently selected envelope

2. Use the **Data Entry Slider** or the {CURSOR} buttons to select the preset envelope value. These preset default envelope values are:

FULL VELRNG	BRASS FLTR	MED CYM	SLOW LFO
FULL ON	SFORZANDO	SHORT CYM	SLOW REPEAT
PIANO DECAY	NORMAL DRUM	WIND PITCH	VIBRATO
STRINGS	TIGHT DRUM	SHORT BLIP	DETUNE LFO
BASS DECAY	PERC 1	TRANSIENT	SHAKUHACHI
GTR DECAY	PERC 2	RAMP UP	SIREN
SOFT MALLET	TIGHT PERC	RAMP DOWN	PITCH DOWN
SLO ATT PAD	TOMS	RAMP UP/DWN	PITCH DOWN2
DECAY PAD	HATS	REPEAT RAMP	ALL ZEROS
LNG RELEASE	LONG CYM	REPEAT TRI	

These envelope values are particularly useful when setting up typical envelopes as starting points when you are creating new voices. Each was designed specifically to be applied to the amplitude (Env 3), filter (Env2), or pitch (Env1). See the following page for a list of all of the envelope parameter values that are installed with the preset default envelopes.

3. After selecting the envelope shape, pressing {ENTER} places it into the voice. The display momentarily shows “Command successful!” then returns to the “Press ENTER to Select Defaults.” page.

KT Default Envelope Values

Env Default	Levels			Time				LevV	AtckV	VelCurv	Mode	Keybd Track
	PEAK	BREAK	SUST	ATTACK	DECAY1	DECAY2	REL					
FULL VELRNG	99	99	99	00	20	20	20	99	00	CONVEX	NORMAL	+00
FULL ON	99	99	99	00	20	20	20	00	00	CONVEX	NORMAL	+00
PIANO DECAY	99	60	00	00	57	68	35	53	00	CONVEX	NORMAL	+28
STRINGS	99	90	86	57	50	50	32	26	40	LINEAR	NORMAL	+14
BASS DECAY	99	71	50	00	48	46	23	46	00	CONVEX	NORMAL	+28
GTR DECAY	99	83	00	00	34	64	23	53	00	CONVEX	NORMAL	+42
SOFT Mallet	99	60	00	10	53	53	29	59	00	CONVEX	NORMAL	+28
SLO ATT PAD	99	95	90	40	50	50	40	26	19	CONVEX	NORMAL	+14
DECAY PAD	99	00	00	00	61	00	51	59	00	CONVEX	NORMAL	+28
LNG RELEASE	99	90	85	57	61	51	78	33	13	LINEAR	NORMAL	+00
BRASS FLTR	99	70	50	38	34	42	18	26	13	CONVEX	NORMAL	+28
SFORZANDO	99	44	81	00	39	35	22	40	00	CONVEX	NORMAL	+14
NORMAL DRUM	99	90	79	00	22	48	24	40	00	CONVEX	NORMAL	+00
TIGHT DRUM	99	85	00	00	10	12	22	53	00	CONVEX	FINISH	+00
PERC 1	99	85	00	00	24	53	22	53	00	CONVEX	FINISH	+00
PERC 2	99	76	00	00	29	50	22	53	00	CONVEX	FINISH	+14
TIGHT PERC	99	85	00	00	06	22	24	59	00	CONVEX	FINISH	+00
TOMS	99	60	00	00	37	19	11	46	00	CONVEX	FINISH	+00
HATS	99	71	00	00	31	50	07	46	00	CONVEX	NORMAL	+00
LONG CYM	99	65	00	00	45	61	17	46	00	CONVEX	FINISH	+00
MED CYM	99	65	00	00	39	53	17	46	00	CONVEX	FINISH	+00
SHORT CYM	99	70	00	00	34	51	17	46	00	CONVEX	FINISH	+00
WIND PITCH	99	99	99	24	20	20	20	00	13	CONVEX	NORMAL	+14
SHORT BLIP	99	00	00	16	04	00	22	00	00	CONVEX	NORMAL	+00
TRANSIENT	99	00	00	00	01	00	01	00	00	CONVEX	NORMAL	+00
RAMP UP	99	99	99	75	50	50	24	00	00	CONVEX	NORMAL	+00
RAMP DOWN	99	00	00	00	64	00	22	00	00	CONVEX	NORMAL	+00
RAMP UP/DWN	00	99	00	00	66	66	00	00	00	CONVEX	REPEAT	+00
REPEAT RAMP	00	99	00	00	31	00	15	00	00	CONVEX	REPEAT	+00
REPEAT TRI	00	99	00	00	15	15	15	00	00	CONVEX	REPEAT	+00
SLOW LFO	00	99	00	00	50	50	50	00	00	CONVEX	REPEAT	+00
SLOW REPEAT	00	50	00	00	50	50	15	00	00	CONVEX	REPEAT	+00
VIBRATO	00	33	00	00	12	12	12	00	00	CONVEX	REPEAT	+00
DETUNE LFO	45	54	45	00	31	32	50	00	00	CONVEX	REPEAT	+00
SHAKUHACHI	50	89	50	01	12	13	62	00	00	CONVEX	NORMAL	+00
SIREN	00	99	00	00	36	36	40	00	00	CONVEX	REPEAT	+00
PITCH DOWN	40	00	00	00	39	00	00	00	00	CONVEX	FINISH	+00
PITCH DOWN2	40	00	00	00	51	00	00	00	00	CONVEX	FINISH	+00
ALL ZEROS	00	00	00	00	00	00	00	00	00	LINEAR	NORMAL	+00

LFO Pages (30 - 32)

The LFO pages contain the parameters related to the Low Frequency Oscillator. Each voice within a sound has its own LFO, which can be assigned as a modulator wherever a modulation source is selected. LFOs are commonly used to create vibrato, tremolo, and other effects.

Edit Sound

page 30 **LFO Rate/Noise Rate**

LFO Rate

Range: 00 to 99

Determines the speed of the LFO. The table below shows the frequency (in hertz) for each value:

LFO FREQUENCIES

value	time (in Hz)	value	time (in Hz)	value	time (in Hz)	value	time (in Hz)	value	time (in Hz)
0	.00	20	.63	40	2.17	60	4.77	80	7.37
1	.01	21	.67	41	2.30	61	4.90	81	7.50
2	.03	22	.70	42	2.43	62	5.03	82	7.63
3	.07	23	.73	43	2.56	63	5.16	83	7.76
4	.10	24	.77	44	2.69	64	5.29	84	7.89
5	.13	25	.80	45	2.82	65	5.42	85	8.02
6	.17	26	.83	46	2.95	66	5.55	86	8.15
7	.20	27	.87	47	3.08	67	5.68	87	8.28
8	.23	28	.90	48	3.21	68	5.81	88	9.28
9	.27	29	.93	49	3.34	69	5.94	89	10.28
10	.30	30	.97	50	3.47	70	6.07	90	11.28
11	.33	31	1.00	51	3.60	71	6.20	91	12.28
12	.37	32	1.13	52	3.73	72	6.33	92	13.28
13	.40	33	1.26	53	3.86	73	6.46	93	14.28
14	.43	34	1.39	54	3.99	74	6.59	94	15.28
15	.47	35	1.52	55	4.12	75	6.72	95	16.28
16	.50	36	1.65	56	4.25	76	6.85	96	17.28
17	.53	37	1.78	57	4.38	77	6.98	97	18.28
18	.57	38	1.91	58	4.51	78	7.11	98	19.28
19	.60	39	2.04	59	4.64	79	7.24	99	20.28

Noise Rate

Range: 00 to 99

Two of the KT's modulation sources are NOISE 1 and NOISE 2. The Noise modulators produce randomly changing levels. Their main use is to randomize or "humanize" pitch when applied as pitch modulator. They can also be used to randomize any other modulation destination.

Typically, they might look like this:

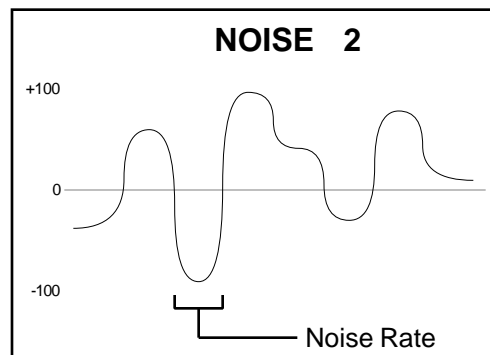
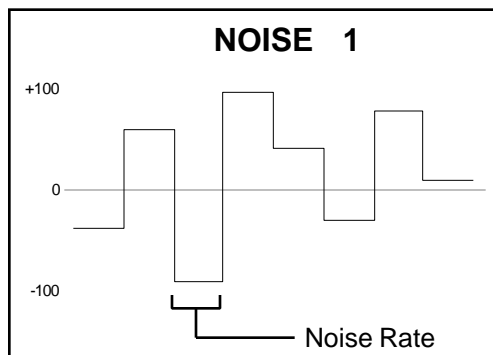

The Noise Rate defines how frequently the levels will change. Low values will cause levels to change very slowly; with high values the levels will change quickly. A rate value of zero will select a different random level with each key down, but the level will not change for as long as the key is held.

Edit Sound

page 31

Depth/Dlay/Mod

```
Depth=99 Dlay=00 Mod=WHEEL
```

Depth

Range: 00 to 99

Sets the “manual” level (or depth) of the LFO; in other words, it controls the initial amount of LFO. The effect of any LFO modulator will be added to this amount.

Dlay

Range: 00 to 99

Determines the time it takes for the LFO to go from zero to the level set with the Depth parameter. This is useful for creating delayed vibrato, tremolo, etc. Higher values give longer delay times. When the LFO rate is at zero, this will create a delayed ramp effect from zero output to the current LFO depth.

Mod

Range: Various

Selects a modulation source for LFO Depth from among the 15 available modulators. The effect of any modulator assigned here will be added to the depth set with the LFO Depth parameter.

Edit Sound

page 32

Wave/Restart

```
Wave = SINE Restart = ON
```

Wave

Range: Listed below

Determines the waveshape of the LFO. There are seven possible values (shown on the next page):

- TRIANGLE — this wave is commonly used to modulate pitch to produce vibrato.
- SINE — a pure fundamental frequency, more rounded in its peaks and valleys than the triangle wave.
- SINE/TRI — a mixture of a sine and triangle wave, a somewhat pointy sine wave.
- POS/SINE — a positive-only sine wave.
- POS/TRI — a positive-only triangle wave useful for simulating vibrato on instruments like the guitar where a player can only bend notes up.
- SAWTOOTH — commonly used for special effects.
- SQUARE — this positive-only square wave is useful for producing in-tune trill effects.

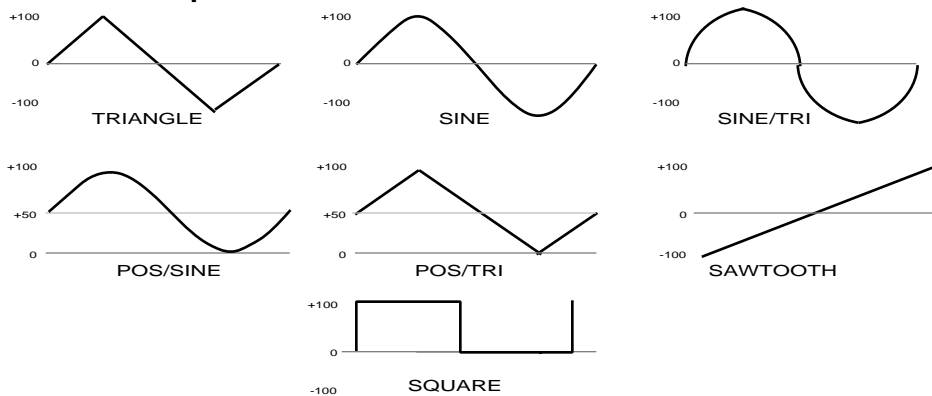
LFO Waveshapes**Restart**

Range: OFF or ON

Determines whether the LFO will restart with each keystrike: When set to OFF, the LFO will cycle continuously without resetting. When set to ON, the LFO waveform will start from the beginning of its cycle each time a new key is struck.

Tip: If you set the LFO Rate to 00, and the Restart parameter to ON, you can use the LFO as a gated modulator with a variable depth. Use Wave = SQUARE, because it starts high.

Filters Pages (40 - 44)

Each KT voice has two filters, Filter 1 and Filter 2, that are connected in series. The filter settings determine which ranges of frequencies will be allowed to pass through to the output.

Edit Sound

page 40 **Filter1/Filter2**

Filter1= 2LoPass Filter2= 2HiPass

Filter1 Range: 2LoPass, 3LoPass

Determines whether Filter 1 will be a 2-pole or 3-pole low pass filter.

Filter2 Range: 2HiPass, 1HiPass, 2LoPass, 1LoPass

Filter 2 can be configured as a 2-pole or 1-pole high pass filter, or a 2-pole or 1-pole low pass filter.

Note: These two parameters are “tied together” — changing the value of one will also change the value of the other.

Edit Sound

page 41 **FC1 Cutoff/Envelope2**

FC1 Cutoff = 055 Envelope2 = +44

FC1 Cutoff Range: 000 to 127

Determines the initial, or manual, filter cutoff frequency. Filter 1 is always a low pass filter. A setting of 127 lets all the original signal pass through the filter. Lower cutoff settings allow fewer high frequencies through, somewhat like turning down the treble on a stereo.

Envelope2 Range: -99 to +99

Determines the amount or depth by which envelope 2 will affect the filter cutoff frequency.

Edit Sound

page 42

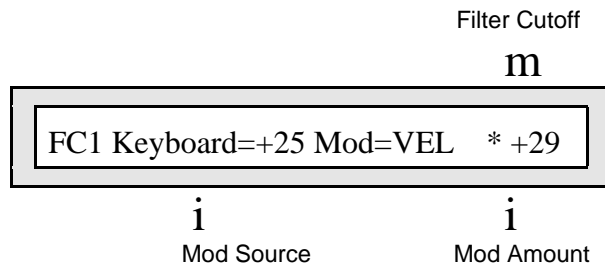
FC1 Keyboard/Mod**FC1 Keyboard**

Range: -99 to +99

Sets the amount by which the location of a note on a keyboard will modulate the filter cutoff frequency (keyboard filter tracking). The scaling effect of this parameter is based on a 76-note keyboard, with a center break-point of F4+. To have the filter track the keyboard exactly, set FC1 Keyboard=+50.

Mod

Range: Various

Selects the source of modulation for the filter cutoff frequency from among the 15 available modulators.

Mod Amount

Range: -99 to +99

Determines the amount that the modulation source will affect the filter cutoff frequency.

Edit Sound

page 43

FC2 Cutoff/Envelope2**FC2 Cutoff**

Range: 000 to 127

Determines the initial, or manual, filter cutoff frequency. When Filter 2 is a low pass filter, it will behave just like Filter 1. When Filter 2 is a high pass filter, a setting of 000 lets all the original signal pass through. Higher cutoff settings on a high pass filter allow fewer low frequencies through, somewhat like turning the bass down on a stereo system.

Envelope2

Range: -99 to +99

Determines the amount that Envelope 2 will affect the filter cutoff frequency.

Edit Sound

page 44

FC2 Keyboard/FC1 Mod⇒FC2**FC2 Keyboard**

Range: -99 to +99

Sets the amount that the location of a note on a keyboard will modulate the filter cutoff frequency (keyboard filter tracking). The scaling effect of this parameter is based on a 76-note keyboard, with a center break-point of F4+. To have the filter track the keyboard exactly, set FC2 Keyboard=+50.

FC1 Mod⇒FC2

Range: OFF or ON

Allows the modulator assigned to FC1 to also modulate FC2. FC2 has no modulation source of its own. Enabling this parameter is the only way to apply modulation to FC2. When “FC1 Mod⇒FC2= ON” the modulation source for FC1 and its modulation amount will be applied to FC2.

Editing the Filters

To Set the Filter Mode

1. Press {EDIT_SOUND}.
 2. Press the upper {4} button.
 3. Press the lower {0} button.
 4. Use the **Data Entry Slider** or the {VALUE} buttons to change the filter mode.
Note that changing the value of one will also change the value of the other.
 5. Use the {CURSOR} buttons to switch between filter 1 and filter 2.
-

To Change the Filter Cutoff Frequency

1. Press {EDIT_SOUND}.
 2. Press the upper {4} button.
 3. Press the lower {1} button.
 4. Use the **Data Entry Slider** or the {VALUE} buttons to change the filter cutoff frequency.
Note that higher cutoff settings allow fewer low frequencies through.
-

To Modulate the Filters

1. Press {EDIT_SOUND}.
 2. Press the upper {4} button.
 3. Press the lower {2} button.
 4. Use the **Data Entry Slider** or the {VALUE} buttons to change the filter modulators.
-

More About Filters

Low Pass/High Pass Filters

A low pass filter allows only those frequencies below the filter cutoff frequency to pass — higher frequencies are filtered out. A high pass filter lets frequencies higher than the cutoff frequency pass and filters out those below. In the KT, Filter 1 is always a low pass filter. Filter 2 can be either a high pass or low pass filter.

Poles: Rolloff Curves

“Pole” is an engineering term that describes the steepness of a filter, or the filter’s cutoff slope. Each additional pole gives a filter a steeper rolloff curve. In the KT, the filter modes are interdependent: that is, the combined number of poles in Filter 1 and Filter 2 is always four.

These four available poles are divided between the two filters; either as 2 and 2, or as 3 and 1. A 1-pole filter will rolloff at 6 dB per octave; a 2-pole filter, at 12 dB per octave; a 3-pole filter, at 18 dB per octave; and a 4-pole filter, at 24 dB per octave. To reproduce a 4-pole low-pass filter (for that “classic” analog synth sound) you would set both filters to 2-pole low-pass; each filter will then rolloff at 12 dB per octave, resulting in a total 24 dB per octave rolloff.

Cutoff Frequency

Every filter has a “knee” in its response curve, known as the cutoff frequency. This is the frequency at which the filter begins filtering out frequencies. The filter cutoff frequency can remain fixed over time, or it can be varied by modulating the filter with an envelope, LFO, velocity, etc.

Filter Configurations

The following diagrams show some possible filter configurations. On the left are the response curves of the two filters shown separately. On the right are some possible shapes of the combined filters.

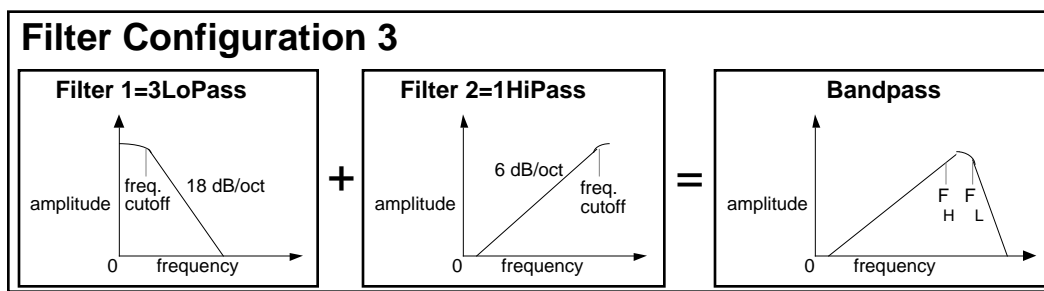
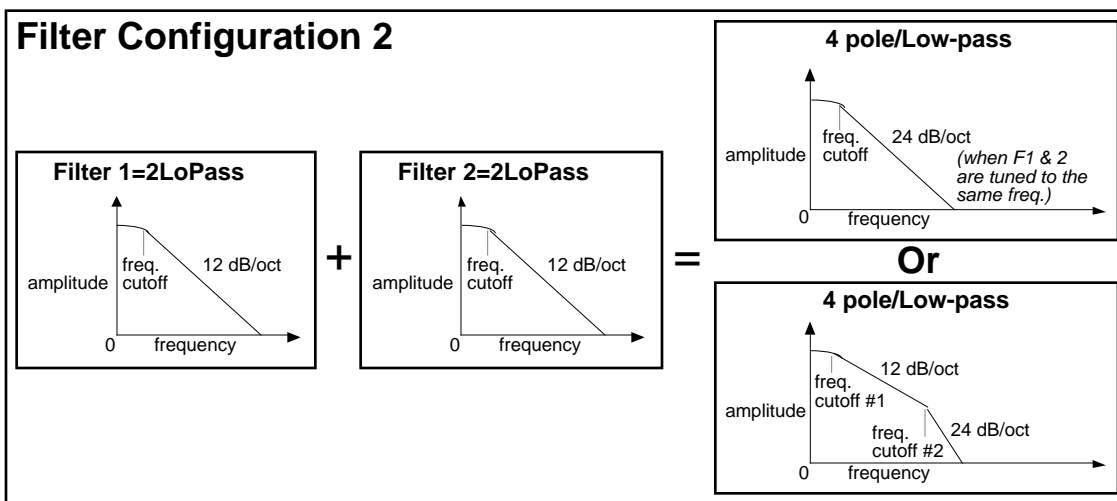
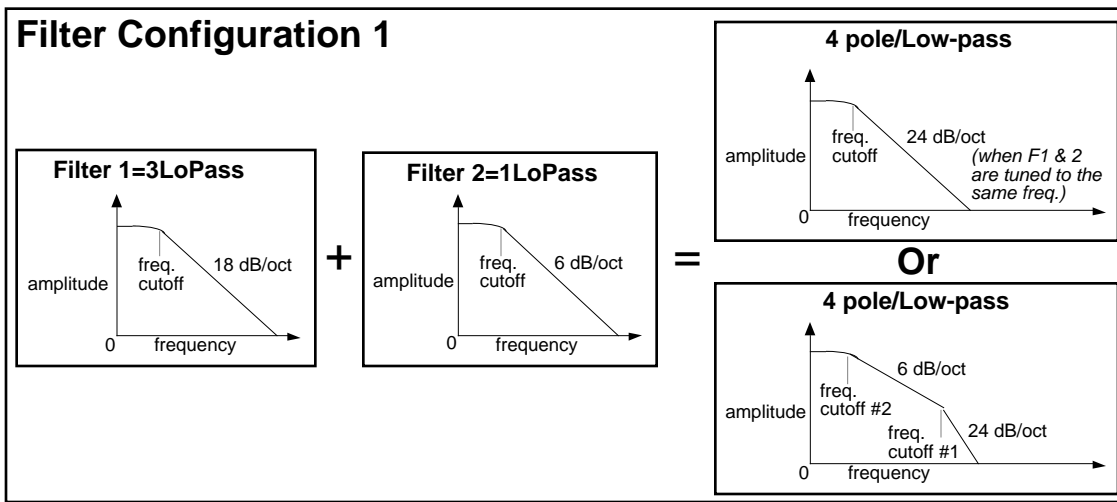

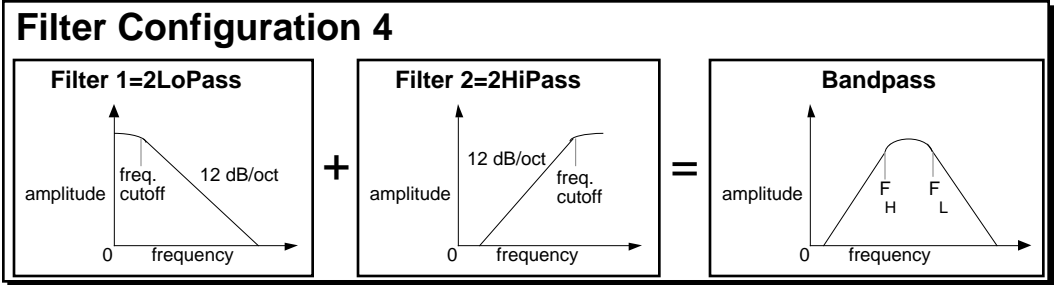

Env2 (50-53) and Env3 Pages (60-63)

The parameters in these pages are identical to those found in the Env1 pages. See the description of Env1 earlier in this section for details. Again, Env1 controls pitch, Env2 controls the filter, and Env3 regulates volume.

Output Pages (70 - 73)

The parameters in the Output page, along with Env3, regulate the overall volume and panning of the voice, along with keyboard scaling, effects routing, and voice reassignment or “voice stealing” priority.

Edit Sound

page 70

Vol/Mod

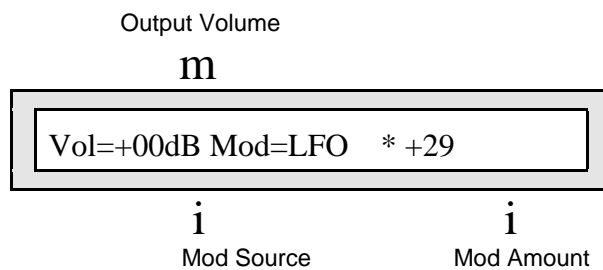

Vol

Range: -50 to +14 dB

Determines the volume of each voice. Since Env3 is permanently routed to the volume of the voice, this parameter could be thought of as the Amplitude Envelope Amount.

Values above +00 dB are intended to let you compensate for the effects of heavy filtering or enveloping, and for the fact that some waves simply have less apparent loudness than others. For example, a percussion sample, which is by nature a quick peak, has less energy than a sustaining square wave. A higher Vol setting lets you raise the level of such waves to equal that of “louder” waves.

Warning:

We strongly recommend against setting Vol levels above +00 to all the waves in your sounds just to make them louder — doing so can result in clipping (distortion) when you play more than one or two notes.

Mod Source

Range: Various

Selects one of the 15 available modulators to affect the volume of the voice. This is in addition to Env3, which is always routed to volume.

Mod Amount

Range: -99 to +99

Determines how much the modulator selected above will affect the volume of the voice.

Tip: By assigning the volume modulators to different voices within a sound, you can create real-time voice crossfading (e.g. making strings swell underneath a piano).

KeybdScale= +00 KeyRange=A0 C8

The following two parameters provide a powerful tool for shaping the volume of the sound across the keyboard:

KeybdScale Range: -99 to +99, or ZONE

Can be used to fade the voice in or out between the two keys specified in the key range. This is good for doing keyboard cross fades between voices, or for reducing the volume of a particular voice as you play higher up the keyboard. A value of +99 will fade the voice in from silence to full level between the low and high keys. A value of -99 will fade the voice out from full level to silence between the low and high keys. Intermediate values will scale the voice from full level to an intermediate level.

With KeybdScale=+99 and KeyRange=A0 to C8:

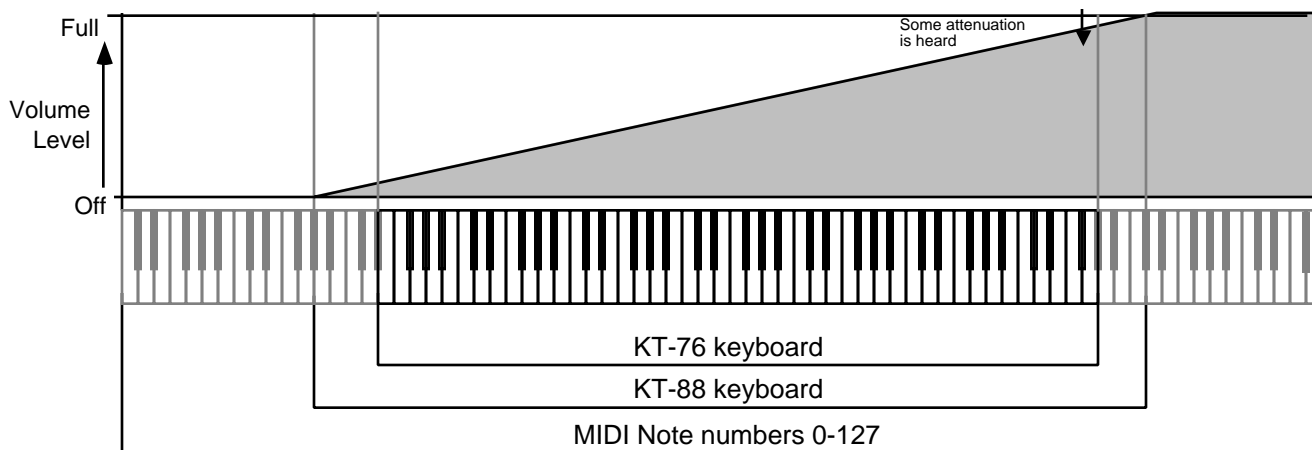

With KeybdScale=-99 and KeyRange=A0 to C8:

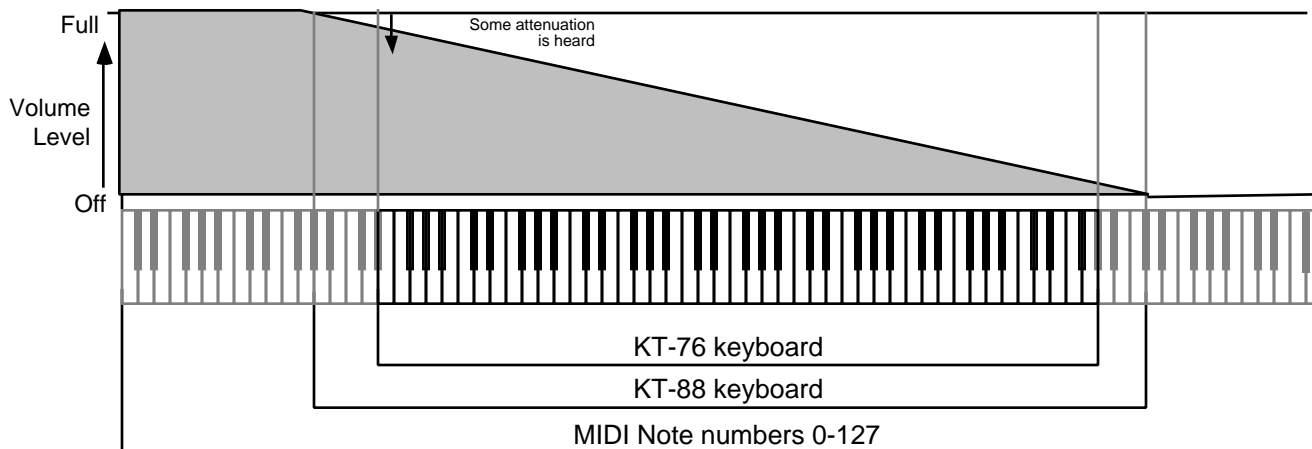

With KeybdScale=-99 and KeyRange=C4 to C5:

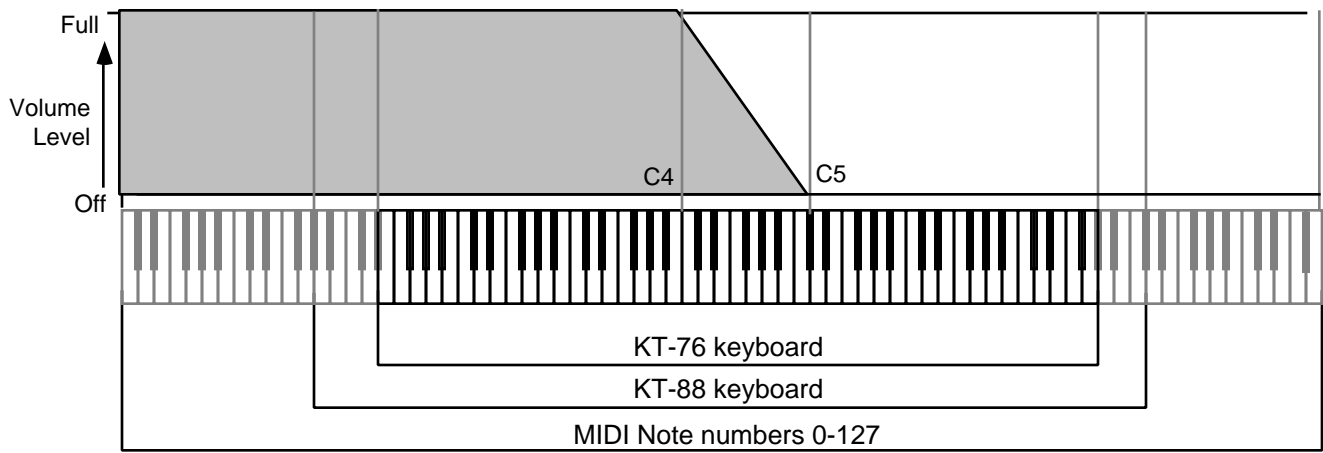

With KeybdScale=+99 and KeyRange=C2 to C6:

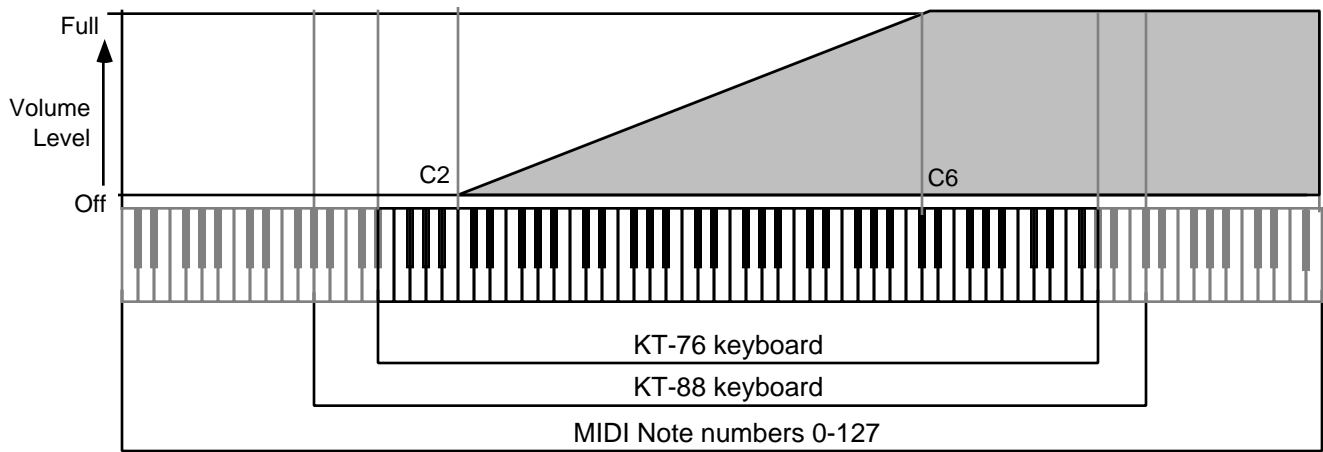

Setting a Keyboard Zone

Moving the **Data Entry Slider** all the way down to the bottom position (below -99) selects **KeybdScale=ZONE**. In this position the voice will sound only over the keyboard range specified by the low and high keys. When **KeybdScale=ZONE**, the volume scaling function is not in effect — the voice will play at the same volume throughout the zone.

With **KeybdScale=ZONE** and **KeyRange=C4 to C5**:

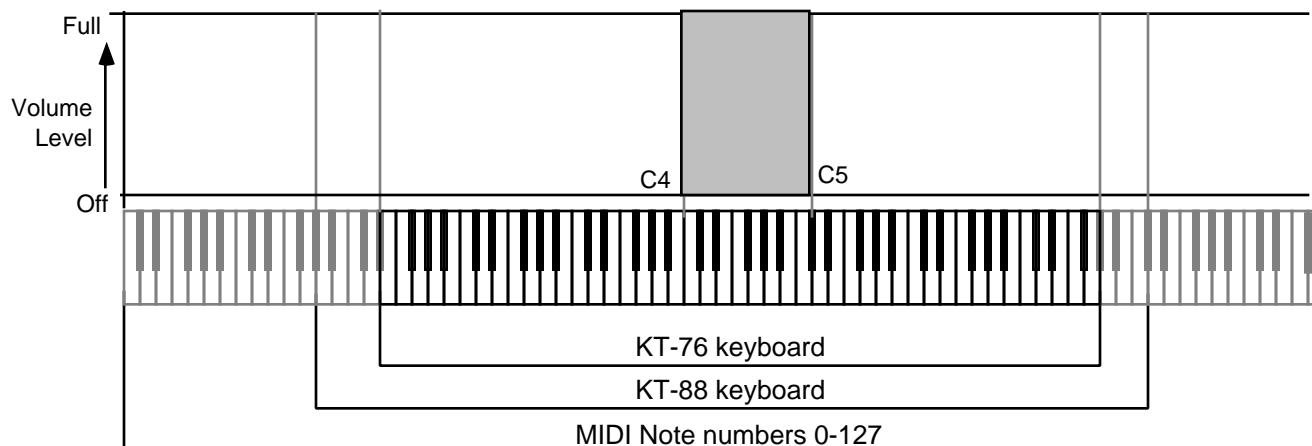

KeyRange

Range: A0 to C8

Sets the key range over which the fade-in, fade-out or keyboard zone will occur. When this parameter is selected, notes can be entered from either the keyboard or by using the **Data Entry Slider** or {VALUE} buttons. Select this parameter and play the low key: the note you played is entered as the low key, and the cursor switches to the high key. Now play the high key: the note you played is entered as the high key, and the cursor disappears. If you made a mistake, or want to enter a different range of values, just select the parameter again and repeat the process.

Output Bus/Priority

Output Bus = FX1 Priority= MEDIUM

Output Bus

Range: DRY, FX1, or FX2

Each voice within a sound can be routed to one of three stereo “busses.” The diagram below shows a typical routing of the signals for each bus. See *Section 3 — Understanding Effects* for more information on effects routing and programming specific effects.

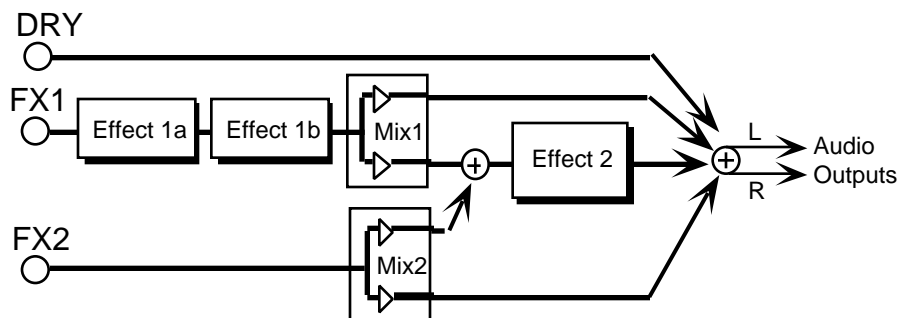
**Priority**

Range: LOW, MEDIUM, or HIGH

Gives you control over how voices will be reassigned, or “stolen,” to play new notes when all the KT’s voices are already playing. A voice can be assigned LOW, MEDIUM or HIGH priority. The rule is that a given voice will only be allowed to steal from voices with the same or lower priority.

MEDIUM is most often used for voices. LOW can be used for voices within a sound that would be missed the least if stolen (such as a voice playing the same wave as another voice but detuned a bit). HIGH is best used only for specific applications in which you want to protect a voice or voices from being stolen — such as drums or a sustaining “pad” sound in a sequencer track.

Edit Sound

page 73

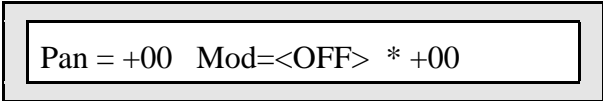
Pan/Mod Source/Mod Amount

Pan = +00 Mod=<OFF> * +00

Pan Range: -98 to +98

Pans the voice within the stereo field. A value of +00 pans the voice center, -98 pans the voice hard left, and +98 pans the voice hard right.

Mod Source Range: various

Selects a modulation source for the voice panning from among the 15 available modulators. This will cause the voice's location in the stereo field to vary with the output level of the modulation source.

Mod Amount Range: -99 to +99

Determines the amount by which the assigned volume modulator will affect the panning of the voice.

Edit Sound

page 74

Vel Window

Vel Window > 000

Vel Window Range: <=124 to >124

Selects a key velocity below which, or above which, the voice will not sound. This allows velocity switching between different voices within the sound. When the value is 000, the parameter will have no effect. Values from 000 to >124 mean that the voice will only play when the key velocity is greater than the number shown. Values from <=016 to <=124 mean that the voice will only play when the key velocity is less than or equal to the number shown.

Section 7 — Drum Sound Parameters

This section covers those functions that can be edited independently for each voice within a Drum sound.

Edit (Drum) Sound Mode

Whenever you want to edit a drum sound, you must first place the KT into Edit (Drum) Sound mode. Once in Edit (Drum) Sound mode you can modify the parameters of a drum sound to better suit your needs or create a completely new sound.

To access the following parameters, first select a drum sound, and then press the {EDIT_SOUND} button to enter Edit Sound mode. In Edit Sound mode, the upper {0} to {9} buttons are used to access the groups of pages relating to sound editing, and the lower {0} to {9} buttons are used to select the pages within that group. This combination of upper and lower buttons is called the page number. Each page in Edit (Drum) Sound mode has a two digit page number.

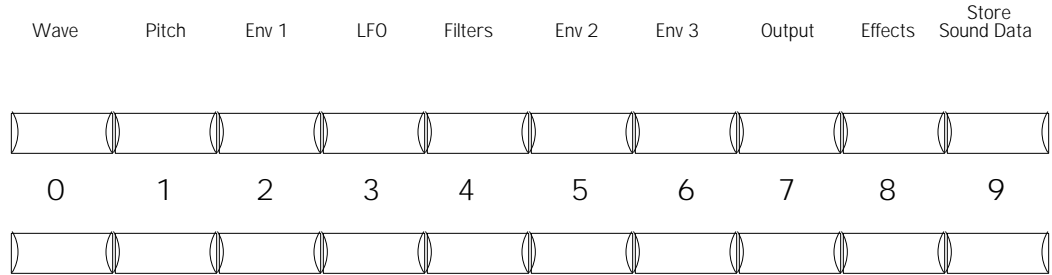

Wave Pages (00 - 05)

In the Wave pages you can choose which wave the currently selected voice will play, and modify various playback parameters of the wave.

Edit Sound
page 00 **Key Range/Wave Name**

Current Key Number	Low Key	High Key
m	m	m

Key=C4 A3#:D4
PUNCHY KICK

i
Wave Name

Current Key Number Range: A0 to C8

This parameter is used to select each of the 17 drum voices for editing.

With a Drum Sound selected (in Edit Sound mode), take a moment to play each key on the KT's keyboard. You'll notice that each time you play a new key, the current key number changes. However, the key range parameters (Low Key and High Key) and the wave name change every several keys. If you count, you'll discover that there are 17 of these changes, corresponding to the 17 voices.

By playing keys on the keyboard, you are selecting a voice to be edited. You can then select a waveform, define a key range and tailor the voice to suit your needs.

Key Range (Low : High) Ranges: A0 to C8

The Low and High Key parameters work together to form a key range, which is the term used to describe the range of notes within which a particular voice will play.

After selecting this parameter, you can set the key range by simply playing the notes on the keyboard where you want the low and high keys to be located. (Low Key is set first, followed by High Key).

Tip: By setting the High Key lower than the Low Key, you can quickly create “blank” inaudible ranges.

Creating “Holes” in the Key Map

It is possible, when setting the key range for a particular voice, to make the current voice “cover up” one or more voices. This would occur if the key range of one voice extended over the entire area of another voice’s key range. The result would be something like this:

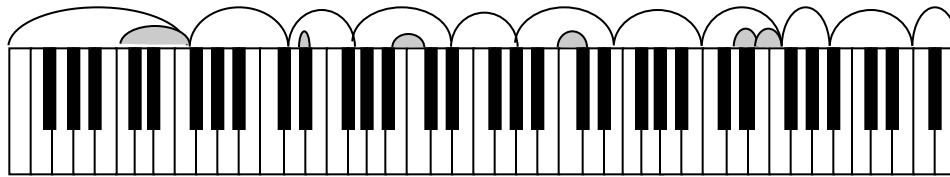

As you can see, the 11 voices defined cover the entire range of the KT-76’s keyboard. This has the effect of “covering up” the remaining six voices (shown in shading).

Now, suppose you wanted to add another voice to the sound (you’ve discovered you just can’t live without tambourine). To make another voice available for the tambourine waveform, you must:

- First, select a key in the range where you’d like the tambourine to be placed. For this example, we’ll choose F6 (the highest shaded key in the diagram).
Next, you’ll need to “create a hole” in the sound’s key map on that particular key.
- Select the voice that currently occupies the F6 key (by playing the F6 key) and reset its key range to where the High Key is E6.

This will have the effect of opening a hole in the key map at F6.

- Play the F6 key to select its voice. You’ll see the display show:

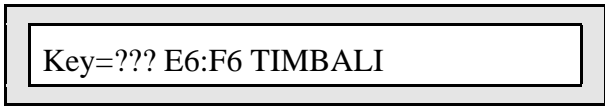

The question marks (???) in a key value indicate that there is no voice range defined to that key. However, you will hear the voice assigned to that key from the “hidden” General MIDI ROM Drum sound that resides beneath the key ranges. As a result the wave name that you see and the wave that you hear may not be the same.

Pressing the key has the effect of selecting the “uncovered” voice and bringing it into the newly created hole.

- To complete the process, define a key range for the voice (for this example F6 : F6), and it will become a permanent voice in the sound. You can then select which wave the voice will play and make other edits, just as you would with any of the voices.

Wave Class/Wave Name

Wave Class

m

Wave=SNARE-DRUM REAL SNARE

i

Wave Name

Wave Class

Range: various (see below)

This parameter determines the class of waves that will be used for a particular voice. After selecting this parameter, you can use the **Data Entry Slider** or the {VALUE} buttons to scroll quickly through the different wave classes to the category you want. Then select the wave name to choose a specific wave from that category.

Whenever the wave class is changed, the first wave in that class is selected.

The KT drum-related wave classes are grouped to aid in creating custom drum sounds. The Wave Classes available for KT Drum Sounds are:

- KICK-DRUM PERCUSSION
- SNARE-DRUM TUNED-PERC
- MISC-DRUM SOUNDEFFECT
- CYMBALS

Wave Name

Range: various

Here you select the actual wave that the voice will play. When this parameter is underlined, the **Data Entry Slider** and the {VALUE} buttons will select only among the waves in the current wave class.

KT Drum Sound ROM Wave Catalog

The Wave Class is shown in bold at the top of each ROM wave group:

KICK-DRUM: PUNCHY KICK ACOUSTIC KICK FAT KICK GATED KICK AMBIENT KICK SYNTH KICK ROOM KICK BRIGHT KICK DRY KICK JAZZ KICK 1 JAZZ KICK 2 ELEC KICK LOOP KICK DANCE KICK	MISC-DRUM: RIMSHOT SIDESTICK 1 SIDESTICK 2 STICK CLICK SYNTH RIM SNARE ROLL BRUSH SLAP BRUSH SWISH BRUSH HIT BRUSH TAP BRUSH TOM DRY TOM ROOM TOM SYNTH DRUM	PERCUSSION: CONGA MUTE CONGA HIGH CONGA LOW TIMBALI BONGO TAIKO SHAKER CABASA MARACAS WOODBLOCK CLAVE GUIRO CUICA VIBRASLAP COWBELL AGOGO TAMBOURINE TRIANGLE SLEIGHBELL FINGER SNAPS WHISTLE SYNTH KISS SYNTH CLAPS SYNTH CLAVE SYNTH COWBELL SYNTH MARACAS CASTANETS GUIRO -KG3 CUICA -KG4 TRIANGLE -KG5 WHISTLE -KG6	TUNED-PERCUS: VIBRAPHONE MARIMBA XYLOPHONE GLOCKENSPIEL TYMPANI STEEL DRUM KALIMBA DOORBELL TUBULAR GAMELAN BELL ORCHESTRA HIT DANCE HIT
SNARE-DRUM: REAL SNARE ROCK SNARE GM SNARE 1 GM SNARE 2 GATED SNARE PUNCHY SNARE CONCERT SNARE DANCE SNARE ELEC SNARE HIP HOP SNARE SYNTH SNARE	CYMBALS: CLOSED HAT 1 CLOSED HAT 2 OPEN HAT 1 OPEN HAT 2 PEDAL HAT CRASH CYMBAL CHINA CRASH RIDE CYMBAL RIDE BELL SYN CLOSEHAT SYN OPEN HAT CLOSED HAT 1-KG1 CLOSED HAT 2-KG1 OPEN HAT 1 -KG1 OPEN HAT 2 -KG1 PEDAL HAT -KG1 SYN CLOSEHAT-KG2 SYN OPEN HAT-KG2		SOUND-EFFECT: BIRD SONG APPLAUSE TELEPHONE GUNSHOT WINDCHIME

About Key Group Waves

You may notice that several of the waves listed above have “-KG(number)” at the end of the wave name. These are called key group waves, and are used for grouped voice cutoff. This effect is optimized for hi-hats. Any wave that ends in the same numbered key group will cut off any currently sounding wave that ends in the same key group number.

For example, if you pressed a key that was assigned OPEN HAT 1 -KG1 and before it decayed, you pressed a key that was assigned CLOSED HAT -KG1 (or any other -KG1 wave), it would automatically cut off the OPEN HAT 1 -KG1 wave. If you were to press a key that was assigned SYN CLOSEHAT-KG2 (or any -KG2 or higher key group numbered wave), OPEN HAT 1 -KG1 would *not* cut off. Likewise, if you pressed a key that was assigned OPEN HAT 1 -KG1 and before it decayed, you pressed a key that was *not* assigned a key group, OPEN HAT 1 -KG1 would *not* cut off.

In order for this feature to work, the keys pressed must *both* have the same key group number.

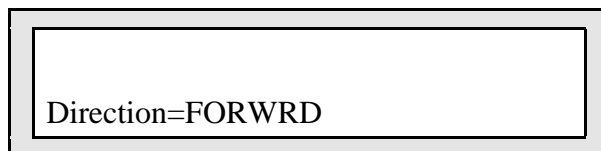
Edit Soundpage 02 **Direction****Direction**

Range: FORWRD or BACKWD

This parameter determines the direction a wave will play, either forward or backward.

Edit Soundpage 03 **Press ENTER to Set GM Map****Press ENTER to Set GM Map**

This command erases the key map currently residing in the edit buffer, setting all the voices to a key range of A0-A0 (i.e. unassigned) and revealing the entire “hidden” ROM General MIDI Drum Map that resides underneath the 17 drum voices.

To reveal the “hidden” General MIDI Drum Map:

- From this page, press {ENTER}.

The display momentarily shows “Command successful!” and then returns to Edit (Drum) Sound page 00.

Because all of the voices are set to a key range of A0-A0, playing the keyboard fails to recognize these ranges, and the display shows incongruous information as you play. As a result the wave name that you see and the wave that you hear may not be the same. The following diagram shows the “hidden” General MIDI Drum map. Note that keys outside of the General MIDI range are silent.

The “Hidden” ROM General MIDI Drum Map

MIDI Note #		General MIDI Drum Map
35	B1	ACOUSTIC KICK
36	C2	PUNCHY KICK
37	C2+	SIDESTICK 1
38	D2	GM SNARE 1
39	D2+	SYNTH CLAPS
40	E2	GM SNARE 2
41	F2	DRY TOM
42	F2+	CLOSED HAT 2-KG1
43	G2	DRY TOM
44	G2+	PEDAL HAT -KG1
45	A2	DRY TOM
46	A2+	OPEN HAT 1 -KG1
47	B2	DRY TOM
48	C3	DRY TOM
49	C3+	CRASH CYMBAL
50	D3	DRY TOM
51	D3+	RIDE CYMBAL
52	E3	CHINA CRASH
53	F3	RIDE BELL
54	F3+	TAMBOURINE
55	G3	CRASH CYMBAL
56	G3+	COWBELL
57	A3	CRASH CYMBAL
58	A3+	VIBRASLAP
59	B3	RIDE CYMBAL
60	C4	BONGO
61	C4+	BONGO
62	D4	CONGA MUTE
63	D4+	CONGA HIGH
64	E4	CONGA LOW
65	F4	TIMBALE
66	F4+	TIMBALE
67	G4	AGOGO
68	G4+	AGOGO
69	A4	CABASA
70	A4+	MARACAS
71	B4	WHISTLE -KG6
72	C5	WHISTLE -KG6
73	C5+	GUIRO -KG3
74	D5	GUIRO -KG3
75	D5+	CLAVES
76	E5	WOODBLOCK
77	F5	WOODBLOCK
78	F5+	CUICA -KG4
79	G5	CUICA -KG4
80	G5+	TRIANGLE -KG5
81	A5	TRIANGLE -KG5
82	A5+	SHAKER
83	B5	SLEIGHBELL
84	C6	WINDCHIME
85	C6+	CASTANET
86	D6	DRY TOM
87	D6+	TAIKO
88	E6	NOT USED

Press ENTER to Set Ensoniq Map

This command erases the key map currently residing in the edit buffer, setting all the voices to the 17-voice default ENSONIQ drum map. This ENSONIQ drum map completely covers up the “hidden” ROM General MIDI drum map. The illustration below shows the default ENSONIQ drum map settings:

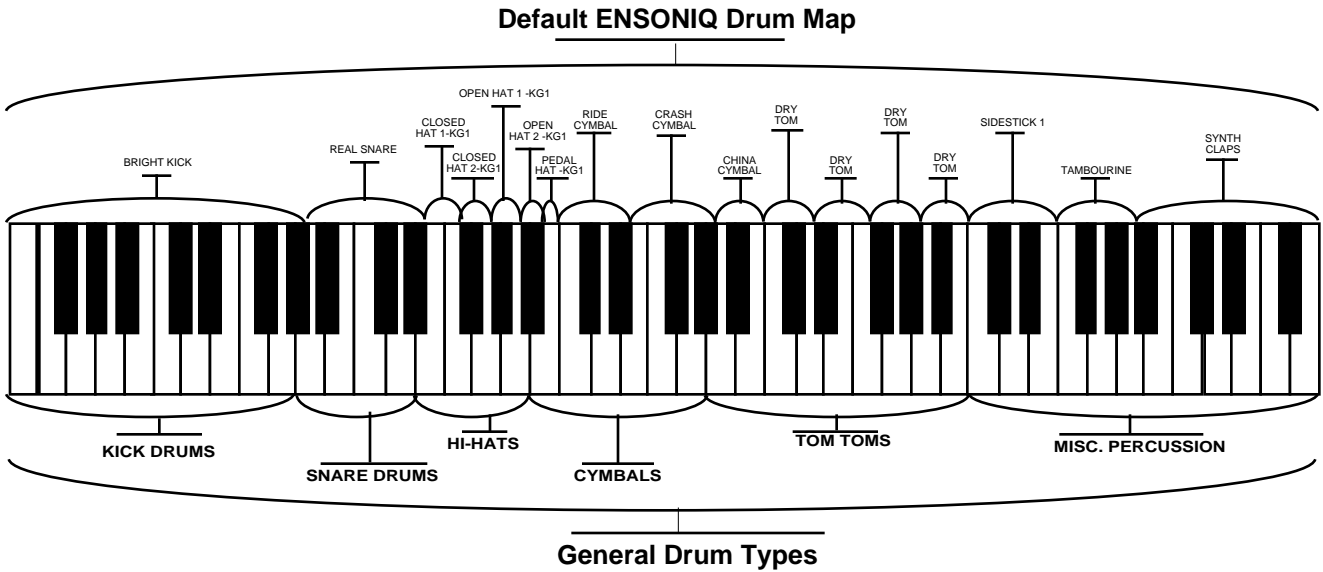

To Set all Voices to the ENSONIQ Drum Map:

- From this page, press {ENTER}.
The display momentarily shows “Command successful!” and then returns to Edit (Drum) Sound page 00.

Change Sound mode

This command allows you to switch the current sound mode between Drum Sounds and Standard Sounds. When working in Edit (Drum) Sound mode, this command will place the default Standard sound into the edit buffer, and place the KT into Edit (Standard) Sound mode.

To Change the Current Sound Mode:

- Press {ENTER}. The display momentarily shows “Command Successful!” changes between modes, and then displays Edit Sound page 00.

Pitch Pages (10 - 11)

In the Pitch pages you set the “manual” levels for the pitch of the voice, and select whether the pitch will be tracked by the keyboard.

Edit Sound

page 10 **Oct/Semi/Fine**

Oct Range: -4 to +4 octaves

Changes the pitch of the voice by octaves.

Semi Range: -11 to +11 semitones

Changes the pitch of the voice by semitones. Incrementing/decrementing this control beyond +11 or -11 automatically increases/decreases the octave by one.

Fine Range: -99 to +99

Changes the pitch of the voice by steps of one cent (1/100 of a semitone).

Edit Sound

page 11 **Keyboard Pitch Tracking**

Keyboard Pitch Tracking Range: ON or OFF

Determines whether or not the pitch of the selected voice will change across the keyboard or remain static.

- ON — The pitch of a voice tracks with the keyboard.
- OFF — All keys play at the same pitch (C4 if the Oscillator Tune parameter has not been edited). If the Oct/Semi/Fine parameters have been edited, the wave's pitch will be transposed by the amount set on the Oct/Semi/Fine page.

Filter Page

The filter settings determine which ranges of frequencies will be allowed to pass through to the output. Drum sounds always have a fixed 4 pole low pass filter. See “More About Filters” in *Section 6 — Standard Sound Parameters* for further details.

Edit Sound

page 40 **Fc Cutoff/LevV**

FC Cutoff = 127 LevV = 00

Fc Cutoff

Range: 000 to 127

Determines the initial, or manual, filter cutoff frequency. A setting of 127 lets all the original signal pass through the filter. Lower cutoff settings allow fewer high frequencies through, somewhat like turning down the treble on a stereo.

LevV

Range: 00 to 99

The Velocity level parameter will lower the filter cutoff with a softer keystrike. This means that the setting you assign to Fc Cutoff is the maximum level — the level that will be reached with the hardest keystrike. The amount of “LevV” will determine how much that level will be reduced as you play softer. With this parameter you can have continuous dynamic control over the filter cutoff by varying how hard you play.

Amp Pages

In the Amp pages you control the volume of the individual voices within a drum sound.

Edit Sound

page 60 **Gate Time/Release Time**

Gate Time

Range: 00 to 99

Determines the fixed amount of time the envelope stays at full level before entering the release stage.

Note: This parameter pertains to FINISH mode only (found on the next page).

Release Time

Range: 00 to 99

In NORMAL mode, this defines the time it will take the envelope to return to zero after the key has been released. When in FINISH mode, this controls the amount of time it takes for a voice to return to zero after the Gate Time.

LevV Range: 00 to 99

The Velocity Level Control parameter will lower the volume with a softer keystroke. This means that the setting you assign to Voice Volume is the maximum level — the level that will be reached with the hardest keystroke. The amount of “LevV” will determine how much that level will be reduced as you play softer. With this parameter you can have continuous dynamic control over the volume by varying how hard you play. Changing the Velocity Curve (VelCurv) gives you further control over the velocity response of the envelope.

Mode Range: NORMAL or FINISH

- **NORMAL** — The envelope plays through normally, as shown in the diagram below.
- **FINISH** — The envelope runs its full cycle, ignoring the key-up event. The envelope waits until the Gate Time is finished to enter the release stage, instead of stopping when the key is released. This is good for percussive-type sounds where you want the envelope to be the same for every note, no matter how long the key is held down.

Stealing Notes

To maximize the use of the KT’s 64 voices, and to manage the “voice stealing,” it is sometimes useful to understand when a given voice will be assigned and when it will be released, or “put back” into the pool for use by other sounds. This depends on a combination of envelope mode and wave type.

A (looped) sustaining wave will continue to use the voice until the envelope reaches zero. For a sustaining wave, when the envelope mode=NORMAL or REPEAT:

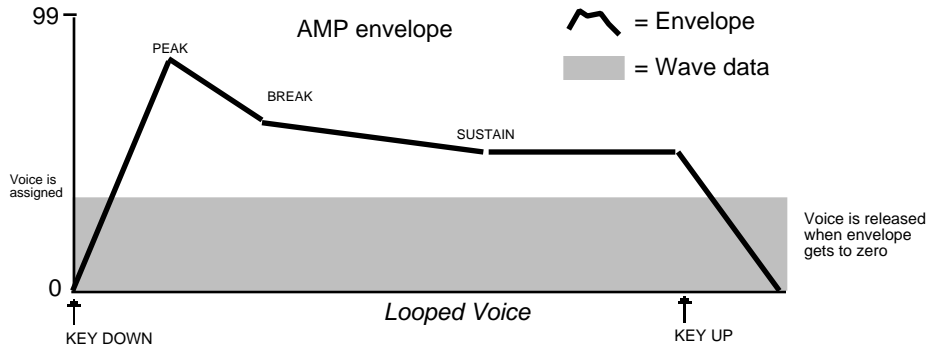

For a sustaining wave, when the envelope mode = FINISH:

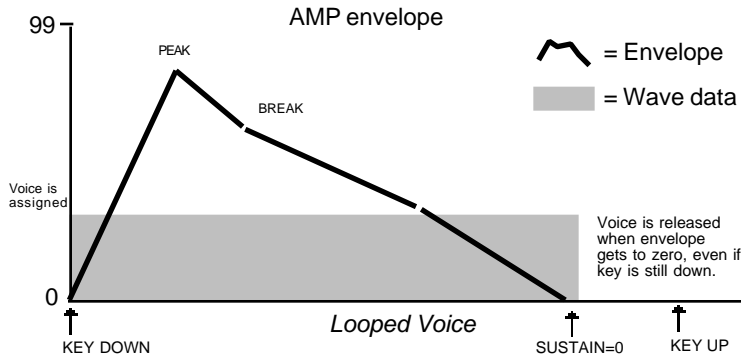

For unlooped, non-sustaining, waves (specifically percussion and drum waves) the voice

becomes free as soon as the sample has played through to the end, no matter where the envelope level is. The voice is released and is available for use by other sounds:

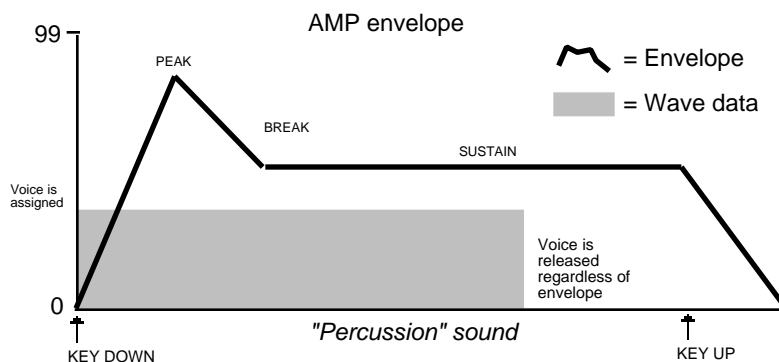

Output Pages (70 - 71)

The parameters in the Output pages regulate the overall volume and panning of the voice.

Edit Sound

page 70 Vol/Pan

Vol Range: -50 to +14 dB

Determines the volume of each drum voice. Since Env3 is permanently routed to the volume of the voice, this parameter could be thought of as Amp Envelope Amount.

Values above +00 dB are intended to let you compensate for the effects of heavy filtering or enveloping, and for the fact that some waves simply have less apparent loudness than others. For example, a percussion sample, which is by nature a quick peak, has less energy than a sustaining square wave. A higher Vol setting lets you raise the level of such waves to equal that of "louder" waves.

Warning:
We strongly recommend against setting Vol levels above +00 to all the waves in your sounds just to make them louder — doing so can result in clipping (distorting) when you play more than one or two notes.

Pan Range: -98 (panned left) to +98 (panned right)

Pans the voice within the stereo mix. A value of +00 centers the voice.

Output Bus

Range: FX1, FX2, or DRY

Each voice within a drum sound can be routed to one of three stereo “busses.” The diagram below shows the general routing of the signals for each bus. See Section 4 — *Understanding Effects* for more on programming specific effects.

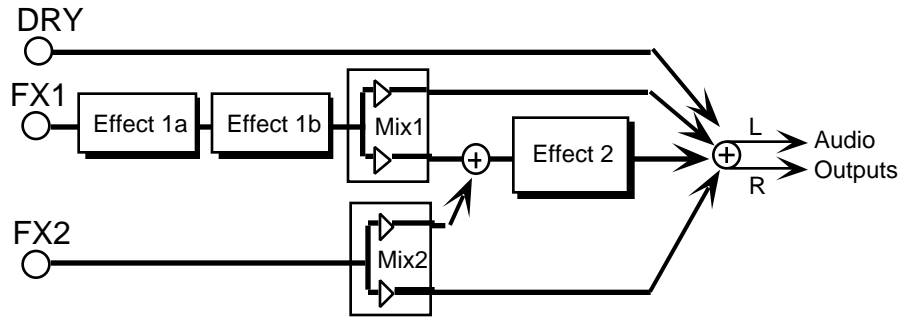

VelCurv

Range: QUIKRISE, CONVEX, LINEAR, and CONCAVE

This selects which of the four available velocity response curves the envelope will use if the velocity level control (the LevV parameter on Edit Sound page 61) is set to some value other than zero.

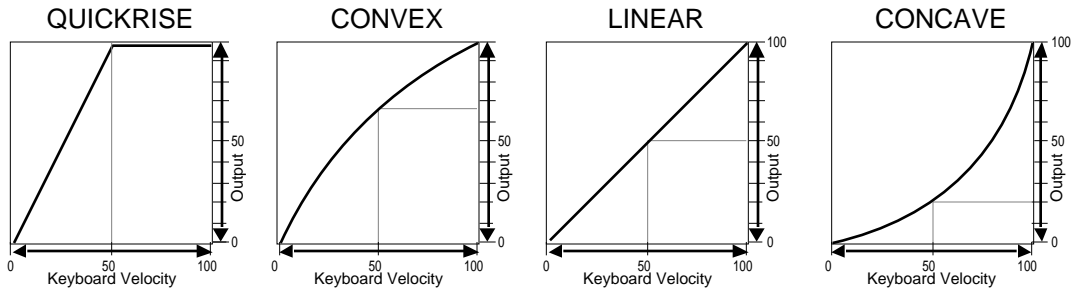

Creating a Custom Drum Kit

Let's say you created a sequence using an r:DRUM ROM sound, but you don't like certain voices within that drum kit. How can you change it?

In this procedure, we will show you how you can edit the voices and their key ranges in your sequenced drum kit, allowing you to create your own custom drum kit.

To Edit the Voices

1. Select the drum kit used in your sequence by pressing the corresponding track button. In this example, we'll use the "Rock Kit-EM" drum sound, found on page 80.
2. Press {SELECT_SOUND}.
3. Press the upper {8} button, followed by the lower {0} button to select "Rock Kit-EM."
4. Whenever you want to do any editing to a sound, you must first place the KT into Edit Sound mode. This is done by pressing the {EDIT_SOUND} button.
5. Press the upper {0} button, followed by the lower {0} button. The display shows:

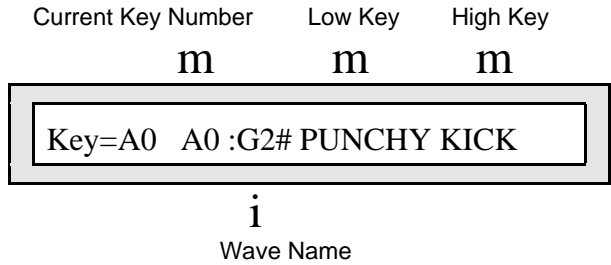

6. Decide which voice(s) you want to replace by playing the keyboard. The display will show the current key number, the wave name, and the key range of that wave.
7. When you've decided which voice to replace, make sure it's selected and on the display (by pressing the appropriate key on the keyboard).
8. Press the upper {0} button, then the lower {1} button. The display looks something like this:

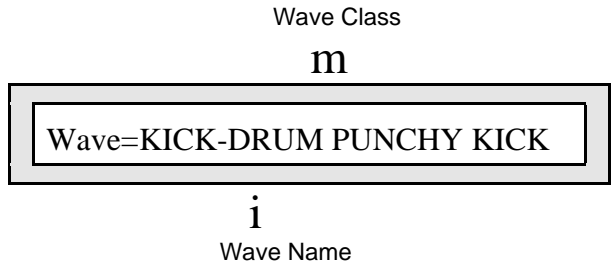

9. Use the **Data Entry Slider** and/or the {VALUE} buttons to scroll through the different waves within the defined wave class to find the sound you want. If you want to select a wave from a different wave class, press the {<} button once. The wave class value will be flashing, and you can use the **Data Entry Slider** and/or the {VALUE} buttons to scroll through the different wave classes.

If you press different keys on the keyboard, the display will show the wave class and wave name for that particular voice range. By using the **Data Entry Slider** and the {VALUE} buttons as described in step 8, you can change all 17 voices within each drum sound.

Setting Key Ranges

“Rock Kit-EM,” like other ENSONIQ drum map sounds, is divided into 17 separate voices as shown below:

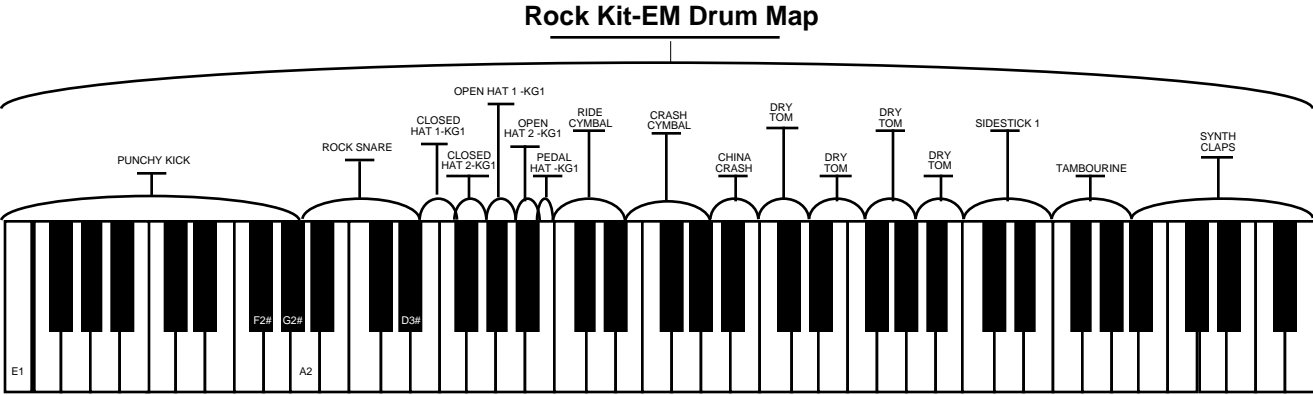

Although you may have changed your voices, your key range is still identical to the map above. In our example, we’re going to change some key ranges of the original voices used in “Rock Kit.”

- Remember, whenever you want to do any editing to a sound, you must first place the KT into Edit Sound mode. This is done by pressing the {EDIT_SOUND} button. The display looks something like this:

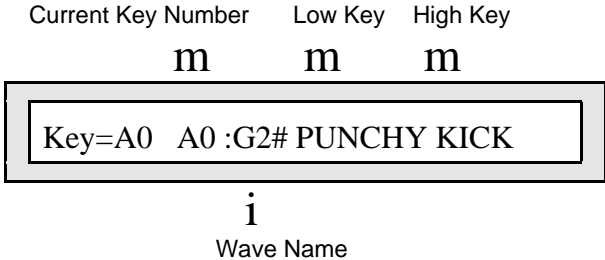

In our example, we will change the key range of PUNCHY KICK and ROCK SNARE.

- Select PUNCHY KICK (by pressing any key within A0 to G2#) and make sure it’s on the display.
- Press the {>} button twice to select the High Key range as shown above.
- Press the F2# key. You’ve just changed the range of the PUNCHY KICK. If you play the G2 and G2# keys, you will hear waves from the “hidden” ROM General MIDI Drum Map sound that lies beneath the key ranges (DRY TOM and PEDAL HAT -KG1 respectively). This is one way to get additional voices in your custom drum map. All of the “hidden” ROM General MIDI Drum Map waves can be found earlier in this section.
- Select ROCK SNARE (by pressing any key within A2 to D3#) and make sure it’s on the display.
- Press the {>} button once to select the Low Key range.
- Press the G2 key. The display automatically selects the High Key range (flashing). Press the D3# key (we don’t want to change the high key, just the low key). You’ve just changed the range of the ROCK SNARE. In doing so, you’ve also covered the “hidden” ROM General MIDI Drum sounds that were exposed by separating the key ranges that covered them. Remember the “hidden” ROM General MIDI Drum sounds are always there... just lurking beneath your definable key ranges.

Using this technique, you can create, change, and edit any drum sound key range within the KT.

Saving Your Edited Drum Kit

Once you've settled on your ultimate drum sound, you need to save it so that it will always be available. Here's how:

1. Press the {SAVE} button. The display will read "Save SOUND <Rock Kit>?" This display allows you to rename your edited drum sound. The name listed is the name of the sound you began with when editing. We recommend renaming your edited sound so that you do not confuse it with the original r:DRUM ROM sound.
2. Select a name of up to 16 characters for your new sound using the **Data Entry Controls**. The {CURSOR} buttons select the character to be edited (underlined), while the **Data Entry Slider** and {VALUE} buttons scroll through the letters, numbers, and symbols that can be used to name the sound (moving the **Data Entry Slider** all the way down gives you a blank space). Note that using dashes, periods, and slashes between characters can make a sound name look better when displayed on Sound Bank pages.
3. After you've written your edited sound's name, press the {SAVE} button.
4. Select a memory location for your sound using the {BANK} button to toggle between the i:INT, a:CARD, and b:CARD banks, and the {0} to {9} buttons (remember page locations 80-99 are ROM Drum sounds, and can't be used). These buttons will display the names of the sounds currently residing in the selected bank's memory. Look for a memory location that contains a sound that you no longer want or use. Sounds that are in memory can be "auditioned" at this point by pressing the {COMPARE} button to toggle between the sound listed on the display, and the sound in the edit buffer.
5. When a location has been found, press the {SAVE} button. The display will show a momentary "Saved." message before returning to the current parameter.

Now that your "Ultimate Drum Kit" has been created and saved, you need to load it into the original track in your sequence, so that the sequencer track will recognize the newly edited sound's location. To do this:

1. Press the {SEQUENCER/PRESET_TRACK} button that has the original drum track.
2. Press the {REPLACE_TRACK_SOUND} button.
3. Press the {BANK} and {0} to {9} buttons to select the memory location where the newly edited drum sound is stored.
4. Press the {REPLACE_TRACK_SOUND} button again to install the newly edited drum sound into the sequencer track.

Section 8 — Understanding Presets

What is a Preset?

A Preset is a combination of up to eight sounds with their corresponding performance parameters, and one effects algorithm which is common to all eight tracks, that can be instantly recalled for use in performance. Presets are handy “performance memories” that allow you to create and save sound combinations, splits, layers, etc. Presets are also used as the basis for sequencing, encompassing all the performance parameters for the sounds used within a sequence.

The eight sounds in a preset reside on eight tracks. For each of these eight tracks, the KT remembers:

- Which sound is assigned to the track
- whether or not the sound is selected or layered
- the values of all Performance Parameters for that track (found on the Edit Track pages)

Selecting Presets

To Select Presets:

- Press {SELECT_SEQ/PRESET}. The {SELECT_SEQ/PRESET} LED will light, indicating that you are in Select Sequence/Preset mode:

Bank Location	A Preset is selected	Preset Memory Location
l	m	n
<div style="border: 1px solid black; padding: 5px; display: inline-block;"> iPSET00 Seq/Preset-00 </div>		
i		
Preset Name		

On the top line you see “context” information about the current preset, and its memory location. Across the lower line, the display shows the name of the preset.

When the {SELECT_SEQ/PRESET} LED is on, it indicates that the KT is in Select Seq/Preset mode, and the upper and lower {0} to {9} buttons will now select sequences or presets (rather than selecting sounds, as they do when the {SELECT_SOUND} LED is on).

How Many Presets are Available in the KT?

There are four banks of 70 Presets/Sequences and 30 Songs, each available in the KT (i:INT (RAM), r:ROM, a:CARD and b:CARD). The r:ROM presets were designed to demonstrate the KT’s ability to create keyboard splits, and layer both KT as well as remote MIDI sound sources. Although we cannot determine what external MIDI sound sources you will be using, these Performance Presets can be invaluable tools in understanding and using your KT keyboard.

What is the Difference Between Presets and Sequences?

A Preset is a combination of eight tracks, each having a sound and a set of performance parameters associated with it. These tracks may or may not be layered.

A Sequence is, in essence, a preset with recorded note data. In fact, a preset forms the foundation of a sequence, containing all the sounds and performance parameters for each track to be recorded. A preset can be thought of as a sequence without note data.

At any point, note data can be added to a preset, making it a sequence. The relationship between presets and sequences looks like this:

<u>Preset</u> Global Effect	<u>Sequence</u>	
Sound & Performance Parameters	Note & Controller Data	Track 1
Sound & Performance Parameters	Note & Controller Data	Track 2
Sound & Performance Parameters	Note & Controller Data	Track 3
Sound & Performance Parameters	Note & Controller Data	Track 4
Sound & Performance Parameters	Note & Controller Data	Track 5
Sound & Performance Parameters	Note & Controller Data	Track 6
Sound & Performance Parameters	Note & Controller Data	Track 7
Sound & Performance Parameters	Note & Controller Data	Track 8

As you can see, a preset is contained within a sequence, acting as a “template” for note data.

What Are Tracks?

In the KT, the term track refers to one of the eight internal “channels” (16 in a song), each containing a sound and a complete set of performance parameters, including volume, pan, controller settings, MIDI channel, keyboard range, and others.

When the KT is used as a multi-timbral sound generator and played from its own sequencer, the various tracks of the sequencer control the sounds to be played by the KT. Similarly, the sequencer or the keyboard of the KT can be used to send on MIDI channels to which remote MIDI devices are connected.

When the KT is controlled from an external MIDI sequencer, the various tracks of the sequencer can be assigned to different MIDI channels, which in turn control the sounds played by the KT (when MIDI Mode=MULTI on System•MIDI page 6). Each MIDI channel can be thought of as an extension of the sequencer’s track.

Whether playing locally, sending MIDI to a remote device, or receiving MIDI from an external sequencer, we describe this logical construct, comprised of a MIDI channel, a sound and various performance parameters, as a *track*.

Each KT preset has eight independent polyphonic tracks that are selected with the eight {SEQUENCER/PRESET_TRACK} buttons:

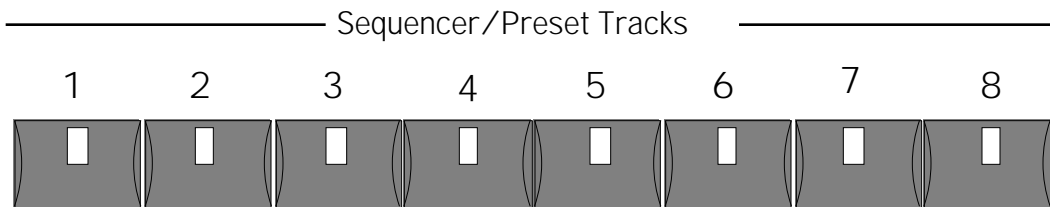

Let’s take a look at the tracks:

- Press {SELECT_SEQ/PRESET}. This puts the KT in Select Sequence/Presets mode.
- Press the {SEQUENCER/PRESET_TRACK} {1} button. The display looks something like this:

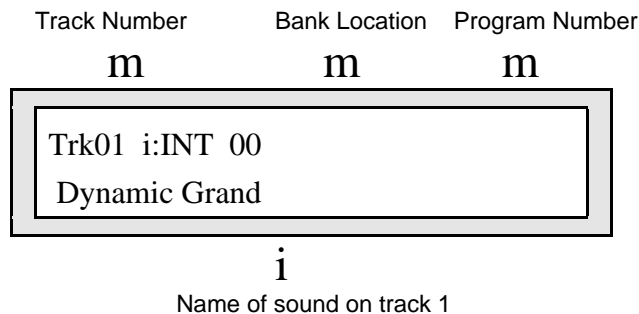

This displays the sound on Track 1. Pressing other {SEQUENCER/PRESET_TRACK} buttons will select the other seven tracks.

Three ways to create a preset

There are three basic ways to create presets on the KT: using the {MAKE_DEFAULT_PRESET} button, building them from “scratch,” or modifying an existing preset. Each is described below.

To create a preset using the default preset

The KT comes with a default preset template (see the heading in this section called “Using the Make Default Preset button” for the technical details of this template), and you may want to simply insert your own sounds into the template, which contains two layered tracks (tracks 1 and 2), a split (tracks 3 and 4), and four tracks dedicated to external MIDI sounds (tracks 5-8). You may also want to copy the template to another location and then customize the copy to more closely suit your needs. Here’s how to do this:

1. From Select Sound mode, press the {MAKE_DEFAULT_PRESET} button. The KT responds by selecting a new internal memory location for your preset. It will place the last two selected sounds into the default preset template. For a complete description of the default preset’s settings, see the heading titled “To Make a Default Preset Template” located in this section.
2. Once the default preset template is loaded, make adjustments to it just as you would when editing any other preset.
3. Save your preset when you are finished making changes by using the {SAVE} button. Once saved, your customized template will be loaded each time you select its location in internal memory.

To Build your own preset

Using layers, splits, or a combination of the two, you can build your own presets with the internal and ROM sounds in the KT. Each sound you select for use in your preset track can be assigned to perform in a specific way using the track parameters described in the *Preset Track Parameters* section of this manual. Here’s a brief description of how to build your own preset:

1. Press the {SELECT_SEQ/PRESET} button. The KT will display the last preset, sequence, or song that was selected.
2. Using the upper {0} through {6} buttons and the lower {0} through {9} buttons, select a new location for your preset. Press {ENTER} when you’re done. The next display asks you to confirm your choice. Press {ENTER} one more time.
3. A display appears asking you to set the time signature. Since the KT doesn’t know whether you’re creating a sequence or a preset (which are similar processes), press {ENTER} twice to confirm both parts of the time signature. The next display asks you to name your preset.

Note: If you are going to use your preset as the basis for a sequence, you *must* set the time signature here. Since we are only creating a preset, with no intention of recording with it, keep the time signature at the default setting of 4/4.

4. Using the {<} and {>} buttons, the **Data Entry Slider**, and the {CURSOR} buttons to spell out the name of your preset. Press {ENTER} when you’re finished. The display will show the name of your preset and its location.
5. Press Sequencer/Preset Track button {1}. The display shows the name of the last sound that was selected.
6. Press the {REPLACE_TRACK_SOUND} button. Notice that the {SELECT_SOUND} button is flashing, meaning that the KT is ready for your to select a new sound for use in track #1 of your preset.
7. Select a sound for the first track of your preset using the upper and lower {0} through {9} buttons, and the {BANK} button (if the sound you want is in a different bank).
8. Press the {REPLACE_TRACK_SOUND}. The sound you selected is now placed on track 1 of

your preset.

- At this point, you have many options. You could “layer” up to eight sounds, one on each track, by first selecting a sound for each track and then double-clicking on the second, third, and higher preset track buttons, each of which selects and “stacks” the sound onto the lower layers. You could split the keyboard, having different sounds play in selected key ranges by adjusting the key range for each track in the preset.

When editing the individual tracks within a preset, you can use all of the functions listed under the lower {0} through {9} buttons (each controls a different aspect of the track) and the upper {8} button (it changes the effect associated with the preset). Your imagination is the only limit! Finally, consider using the Layer Lock feature as you make edits. It lets you hear the current combination of selected and layered tracks while in the edit track mode so that you can evaluate the overall result of your changes.

- When you’re done, save your preset by pressing the {SAVE} button twice (once to confirm the name of the preset, which you could change at this time, and once to save the preset.)

To modify an existing preset

When you have a preset that you already like, but want to create something only slightly different and still keep the original, consider copying it to a new location. You can then rename it and modify it as necessary. Here’s how:

Note: You cannot copy presets that reside in the ROM area of memory, only those that reside in the Internal area (i.e. ones that you created), or on a RAM card. ROM presets can be imported, however. See *Section 11—Sequencer Parameters* for details.

- In Select Seq/Preset mode, select the preset that you want to modify.
- Press the {COPY_PRESET} button. The display asks you to select the preset that you want to copy. Since you’ve already done this, simply press {ENTER}. A display will appear asking you to select a location for the preset.
- Specify a new location for the preset using the **Data Entry Slider** and/or the {[} and {]} Value buttons, and press {ENTER} when you’re done. The KT prompts you to name the preset.
- Use the data entry controls to enter a new name if desired, and press {ENTER}. The KT copies, renames, and then selects the new location that you specified.
- Your preset is now ready for editing. As you make changes to each individual preset track, consider listening to the effect of your individual edits on the overall preset by using the Layer Lock feature. If you want to replace one sound in a preset, use the {REPLACE_TRACK_SOUND} button. Double-click on this button to replace a track *along with* its effect.
- When you’re done, save your preset by pressing the {SAVE} button twice (once to confirm the name of the preset, which you could change at this time; and once to save the preset).

Layering Sounds with the Track Buttons

In a preset, a maximum of seven sounds may be layered with the selected sound. You can have up to eight sounds layered (stacked) on one key, or up to eight different sounds split across the keyboard by using the Key Range function described later in this section.

To layer sounds in presets:

1. Press {SELECT_SEQ/PRESET}, then select one of the 8 tracks.
2. Double-click (press two times quickly) the {SEQUENCER/PRESET_TRACK} button for the track you wish to layer. Layered tracks are identified by a flashing LED. If a track is layered (flashing LED), it can be unlayered by pressing its {SEQUENCER/PRESET_TRACK} button again.

Using Effects With Performance Presets

All eight tracks in a sequence or preset share the same effects algorithm. Effects settings can be edited from the Effects pages (press {EDIT_SEQ/PRESET}, then the upper {8} button), with the same parameters available as in Edit Sound mode. The effects algorithm for the sequence, preset, or song is inherited from the current sequencer effect at the time they were created. If this effect is incompatible with other sounds in the preset, sequence, or song, there are several options:

- Set the effects routing to DRY for any of the sounds that are incompatible (see {EDIT_TRACK} page 1, in *Section 9 — Preset/Track Parameters*).
- Change the preset/sequence effect algorithm to be something more suitable (see *Section 3 — Understanding Effects* for details on editing the effect parameters).

Using the Replace Track Sound Function

Pressing the {REPLACE_TRACK_SOUND} button lights its LED, and places the KT into Replace Track Sound mode. This mode allows sounds on the individual tracks of a preset/sequence or song to be assigned and changed.

Replacing the Sound on a Track

To replace the current sound on a track:

1. Press the {REPLACE_TRACK_SOUND} button from either Edit or Select Sequence/Preset mode. The {REPLACE_TRACK_SOUND} LED will be solidly lit. The display shows the track number, the bank and program number where the track's sound is stored and the name of the sound on the track.

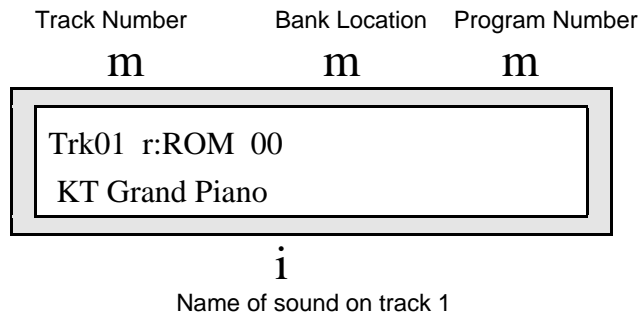

2. Use the {0} to {9} buttons (or the {VALUE} buttons) to change sounds on the currently displayed track. In Replace Track Sound mode, the {0} to {9} buttons select new sounds for the current track, rather than selecting songs, sequences, or parameter pages.
3. To select a sound from a different bank, either repeatedly press {BANK}, or while holding down {BANK}, press the lower numbered buttons {0}, {1}, {2}, or {3} to select the desired bank (i:INT, r:ROM, a:CARD or b:CARD respectively).
4. Press {REPLACE_TRACK_SOUND} again to exit Replace Track Sound mode, and replace the sound with the newly selected one.
 - To change the currently displayed track, press any {SEQUENCER/PRESET_TRACK} button.
 - The {EDIT_TRACK}, lower {4} button (MIDI Program =###) is automatically updated whenever a sound is replaced on a track.

Using SoundFinder in Presets Mode

Here's how to scroll through sounds that have the same defined SoundFinder type in Presets Mode:

1. Press the {REPLACE_TRACK_SOUND} button from either Edit or Select Sequence/Preset mode. The {REPLACE_TRACK_SOUND} LED will be solidly lit.
2. Use the {SOUNDFINDER} buttons (which are the {CURSOR} buttons) to scroll through all of the sounds with the same defined SoundFinder type (found by pressing {EDIT_SOUND}, the upper {0}, then the lower {6} button). Note that you don't have to press {BANK} to change banks — SoundFinder will automatically do that for you.
3. Press {REPLACE_TRACK_SOUND} again to exit Replace Track Sound mode, and replace the sound with the one you just selected using the SoundFinder feature.

Replacing the Sound along with its Effect on a Track

To copy a sound along with its effect onto a preset track (replacing the current preset effect with the one in the sound), use the “Replace w/FX” function. This function works slightly differently, depending on which mode it is performed from.

From Edit Sequence/Preset mode:

1. Press {EDIT_SEQ/PRESET}. The KT will enter Edit Sequence/Preset mode (LED on).
2. Press the {SEQUENCER/PRESET_TRACK} button of the track that you want to replace.
3. Double-click (press twice rapidly) the {REPLACE_TRACK_SOUND} button. Its LED will be flashing.
4. Use the {BANK}, the {0} to {9}, and/or the {SOUNDFINDER} buttons to find the sound that contains the effect you would like to install in the current preset.
5. Press {REPLACE_TRACK_SOUND} again to permanently install the newly selected sound and its effect setting. This exits Replace Track Sound mode, and the KT will return to Edit Sequence/Preset mode.

Tip: Holding the {EDIT_SEQ/PRESET} button down while pressing a Track button causes the KT to enter into Replace Track Sound mode, copies the current sound in Sounds mode onto a track, and copies its effect into the seq/song effect (like Replace w/FX).

Replacing Additional Tracks

You can continue replacing track sounds, by skipping step #5, and doing the following:

6. Press another {SEQUENCER/PRESET_TRACK} button.
7. Use the {BANK}, the {0} to {9}, {VALUE}, and/or the {SOUNDFINDER} buttons to find the sound that you would like to install into the newly selected track.
8. At this point, you can press another {SEQUENCER/PRESET_TRACK} button, and repeat these steps for as many tracks as you would like to replace.
9. Press {REPLACE_TRACK_SOUND} to exit Replace Track Sound mode.

From Select Sequence/Preset mode:

1. Press {SELECT_SEQ/PRESET}. The KT will enter Select Sequences/Presets mode (LED on).
2. Select and/or double-click any combination of {SEQUENCER/PRESET_TRACK} buttons to select and/or layer any desired combination of sounds. The track number shown in the upper left corner of the display is the one that is selected for editing (the one we will be replacing with a new sound and its effect settings).
3. Use the {CURSOR} buttons to select the track that you would like to replace. This allows you to replace the sound on any track and install its effect setting into the preset, without changing which tracks are selected and/or layered.
4. Double-click the {REPLACE_TRACK_SOUND} button. It's LED will flash.
5. Use the {BANK}, the {0} to {9}, and/or the {SOUNDFINDER} buttons to find the sound that contains the effect you would like to install into the current preset.
6. Press {REPLACE_TRACK_SOUND} again to install the newly selected sound and its effect setting. This exits Replace Track Sound mode, and the KT will return to Select Sequence/Preset mode. The newly installed sound's effect setting becomes the current preset effect. The layered combination of tracks will not change. This allows you to replace the effect settings for a layered combination of tracks without changing which tracks are selected and/or layered.

A Note about Replacing Sounds Used by Sequences/Presets

If you overwrite an i:INT (RAM), a:CARD, or b:CARD sound that was used in a sequence or preset, the new sound will be selected by that sequence/preset. This is because the sequence/preset “points to” the sound location only, not the actual sound.

Using Card Sounds in a Seq/Preset or Song

If you have created a sequence/preset or song that uses a sound from either the a:CARD or b:CARD bank location, and the card isn't installed, the track will be silenced, and the Sequence/Preset track will show:

Selected Track	Recorded Data Symbol	Bank Location	Card Location
1	m	m	m
<div style="border: 1px solid black; padding: 5px; width: fit-content; margin: 0 auto;"> Trk01£ a:CARD 17 a:CARD Sound #17 </div>			
i			

Sound name changes to show Card Location.

This will also appear if you have a different card installed, and it does not have any recorded Sound data.

If you have created a sequence/preset or song that uses a sound from either the a:CARD or b:CARD bank location, and you have a different card installed that does has Sound data, the track will use the sound from the same Card location. As in the example above, you will hear the sound from the a:CARD bank location #17, even though it may not be the intended sound. This is because the sequence/preset recognizes the sound location only, not the actual sound.

About Edit Track (Performance) Parameters

A group of Performance Parameters is associated with each sequence/preset track. These parameters control various aspects of the track, including some important and useful sound controls that may be easily adjusted during performance or recorded into the sequencer. The settings of these track parameters are saved with every preset. These instantly recallable presets include an effect setup and eight sounds on eight tracks with a full set of programmable performance parameters, including key ranges, transpositions, and others. The settings of all performance parameters on preset, sequencer and song tracks are saved for each track and are maintained while the power is off.

All Performance Parameters are found under the lower {0} to {9} buttons in Edit Track mode, as labeled on the front panel:

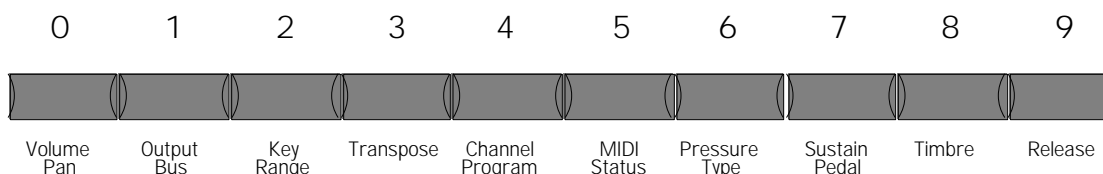

Pressing {EDIT_TRACK}, followed by the appropriate lower {0} to {9} button will access the Edit Track (Performance) parameters. The Edit Track parameters are:

Screen #	Parameter	Description
0	Volume	overall track volume level
0	Pan	stereo panning control for track sound
1	Output Bus	controls routing of track to effects
2	Key Range	set track keyboard ranges or limits
3	Transpose	track pitch transposition
4	(MIDI) Channel	track MIDI channel number
4	(MIDI) Program	track MIDI program number
5	(MIDI) Status	enable or defeat MIDI transmission & reception
6	Pressure Type	type of pressure responded to via MIDI (also enables or defeats KT Channel Pressure transmission)
7	Sustain Pedal	enables or disables the sustain pedal
8	Timbre	programmable sound variation control
9	Release	sound release time adjustment

These parameters can be used to create complex performance set-ups for your KT and other MIDI equipment. For a full description of the performance/track parameters and their functions see *Section 9 — Preset/Track Parameters*.

Using the Layer Lock Feature

Normally, when the {EDIT_TRACK} button is pressed, the KT enters Edit Sequence/Presets mode. So, the last track selected or layered will be selected for parameter editing, and only one track will be audible at a time. Layering of tracks is not normally available in Edit Sequence/Presets mode. By using the Layer Lock function, the current combination of selected and layered tracks can be dynamically “Locked” to allow Track Performance parameter editing while tracks are layered. This allows you to edit the Performance Parameters for one track, while still being able to play the full combination of multiple layered tracks, making it possible to adjust each track’s Performance Parameters relative to the other tracks in the layer combination.

To “Lock” a Track Layer combination:

1. Press {SELECT_SEQ/PRESET}.
2. Press a {SEQUENCER/PRESET_TRACK} button and layer any combination of tracks, by double-clicking their {SEQUENCER/PRESET_TRACK} buttons.
3. While holding down the {SELECT_SEQ/PRESET} button, press the {EDIT_TRACK} button. Both the {SELECT_SEQ/PRESET} and {EDIT_TRACK} LEDs will light and the KT will now be in “Layer Lock” Edit Track mode. All Edit Track Performance Parameter pages are available as usual: from either successive presses of the {EDIT_TRACK} button, pressing the {CURSOR} buttons, or by “direct dialing” with the lower {0} to {9} buttons.
4. Pressing a {SEQUENCER/PRESET_TRACK} button will not change the combination of layered tracks, but instead will select that track for Performance Parameter editing.
5. To exit “Layer Lock” Edit Track mode, press any mode button.

About the “Save Changes?” Page

Along with the notes, controllers and program changes that are recorded on each track, there are many other parameters that are saved with each sequence or song. These are:

- The name of the sequence or song
- The tempo of the sequence or song
- The sound assigned to each track
- All Edit Track parameters for each track of the sequence or song
- Which tracks are selected and layered on the tracks
- The setting of the LOOP parameter in the Sequencer Control pages
- The setting of the CLICK parameter in the Click pages
- Punch-In and Punch-Out points

Whenever you record a track of a sequence or song, these values are automatically saved — that is, they will be remembered by the KT if you leave the sequence (by selecting another one) and return to it later. However, if you change any of the above settings, and then select a new sequence or song before you record any new track data, the following message may appear, depending on the setting of the SaveChangesMode parameter (press {EDIT_SEQ/PRESET}, the upper {1}, then the lower {5} button). See the description of this parameter for more information:

Save Changes? <SEQUENCE NAME>

- Pressing {YES} saves the sequence or song, with the current settings of all the parameters listed above, into sequencer memory.
- Pressing {NO} leaves the settings of the parameters listed above as they were when you last recorded a track.

In either case, the track data (notes, controllers and program changes) is always saved. Sometimes it’s hard to remember, when you get this page, exactly what you changed. As a rule, if you are happy with the sequence or song as it is, answer YES. If you have just been experimenting with different tempos, programs, MIDI configurations, etc., and want to leave the sequence as it was before your experiments, answer NO.

Tip: While in Select Sequence/Presets mode, there is one quick way to save any changes you make to a Preset or Song. Simply press {ENTER} twice. You can also rename the Preset or Song by pressing {ENTER} once, editing the name, and then pressing {ENTER} again. Do not attempt this with a Sequence — it will invoke the Tap Tempo feature (see the Tap Tempo description earlier in this section).

As mentioned above, you can avoid being asked to save changes by setting the Save Changes parameter to U-SAVE MANUALLY. For live performance, and other applications in which you want to experiment with tempo, track parameters, etc. without being bothered about saving the changes, this is the preferred setting.

Using the Make Default Preset Button

The {MAKE_DEFAULT_PRESET} button performs different functions depending on whether you are in Select Seq/Preset or Edit Seq/Preset mode. The Make Default Preset function will only work in the currently selected bank.

To Play The Demo

Holding down the {MAKE_DEFAULT_PRESET} button and pressing the {PLAY} button will select r:ROM Song 70 and will start playback of the Demo Song. Changes made to the current sequence will be automatically saved, as if SaveChangesMode=EDITS AUTO-MAILED.

To Make a Default Preset Template

When you are in either Select Sound or Edit Sound mode, or when you are in Edit Seq/Preset mode and the currently selected bank is i:INT, pressing the {MAKE_DEFAULT_PRESET} button will define a new i:INT preset location (if one is available). If all 70 locations have been defined, the display will show “SORRY! No free Seq location.”

When the current Seq/Preset mode bank is a:CARD or b:CARD, pressing the {MAKE_DEFAULT_PRESET} button will define a new preset location in the current CARD bank (if one is available). If all 70 locations have been defined, the “SORRY! No free Seq location” message will be displayed.

When the current Seq/Preset mode bank is r:ROM, pressing the {MAKE_DEFAULT_PRESET} button will change the Seq/Preset mode bank to i:INT, and then will define a new i:INT preset location (if one is available). If all 70 locations have been defined, the “SORRY! No free Seq location” message will be displayed.

If the current Seq/Preset Track parameters have been edited, the “Save Changes?” prompt will be displayed before the current Seq/Preset settings are overwritten with the Default Preset settings. (Remember: the “Save Changes?” prompt can be disabled with the SaveChangesMode parameter ({EDIT_SEQ/PRESET}, the upper {1}, then the lower {5} button). The new preset that is created is automatically configured as the Default Preset template, as shown here:

Track	1	2	3	4	5	6	7	8
Status	LOCAL	LOCAL	LOCAL	LOCAL	*EXT*	*EXT*	*EXT*	*EXT*
Key Zone	Full	Full	Lower	Upper	Full	Full	Lower	Upper
Channel	Base	Base	Base	Base	Base	Base	Base	Base
Sound	Current	Previous	Current	Current	(silent)	(silent)	(silent)	(silent)

The Default Preset template serves as a standard starting place for MIDI Master Keyboard operations. It is configured as follows:

- The sound that was selected in Sounds mode when the {MAKE_DEFAULT_PRESET} button was pressed is copied to Tracks 1, 3, 4, 5, 7 and 8. Its effects settings will be loaded into the ESP.
- The second-to-last sound that had been selected in Sounds mode will be copied to Tracks 2 and 6. This provides instant access to layering possibilities.
- All Track MIDI Channels will default to the Base Channel, as set on System•MIDI page 4.
- Tracks 1-4 MIDI Status will default to Status = LOCAL.
- Tracks 5-8 MIDI Status will default to Status = *EXT*.
- If System•MIDI page 4 Base Channel Status = LOCAL, the Default Preset will have only Track 1 selected.
- If System•MIDI page 4 Base Channel Status = BOTH, the Default Preset will have Track 1 layered with Track 5.

- If System •MIDI page 4 Base Channel Status = MIDI or *EXT*, the Default Preset will have only Track 5 selected.
- Tracks 3 and 7 will both have their Key Range default to KeyRange = A0-B3. This provides instant access to keyboard splits on the lower half of the keyboard, both locally and via MIDI.
- Tracks 4 and 8 will both have their Key Range default to KeyRange = C4-C8. This provides instant access to keyboard splits on the upper half of the keyboard, both locally and via MIDI.
- The name of the new preset will default to “Seq/Preset-##” with the ## field defaulting to the memory location number to which the Preset is automatically saved. This name can be changed at any time with the “Rename SEQ/Pset” command ({EDIT_SEQ/PRESET}, upper {4}, then the lower {4} button). For more information about these parameters, see *Section 9 — Preset/Track Parameters*.

When a Default Preset template is created, it has no time signature. Pressing the {RECORD} button with a Default Preset template selected will bring up the Time Signature selection page, prompting you to select a Time Signature, just as if you were creating a new sequence in an *EMPTY SEQ/PSET* location. Use the **Data Entry Controls** to set the time signature. When you press the {ENTER} button, the click (metronome) will start, and you can begin recording. After pressing the {STOP"CONTINUE} button from Record, you will be prompted to “Keep first ### bars?” as per normal sequencer operation. From this point onward, the Default Preset template will behave just like any other sequence.

To Copy Preset Data

When in Select or Edit Seq/Preset mode, pressing {MAKE_DEFAULT_PRESET} will perform the Copy Preset function, as labeled on the front panel beneath the button. The Copy Preset function will copy the Preset data from the currently selected Preset, Sequence, or Song to any other *EMPTY SEQ/PSET* or *EMPTY SONG* memory location within the same bank. The Copy Preset function does not, however, copy the time signature or any unsaved edited changes from the source to the destination. If you want to make an edited version of the current preset settings, we recommend copying it first, and then editing the copied version. The destination preset will behave like a Default Preset template, as described above.

When a sequence is selected, you can copy the sequence preset data to any undefined sequence. When a song is selected, you can copy the song preset data to any undefined song.

To Copy Preset Data to an Undefined Preset/Sequence or Song Location (in the same bank):

1. Choose any defined sequence or preset.
2. Press the {MAKE_DEFAULT_PRESET} button. The display will show:

Copy FROM Preset <Sequence Name>

The display shows the currently selected sequence.

3. Press {ENTER}. The display shows:

TO Sequence Location = ##

4. You can now use the **Data Entry Slider** or the {VALUE} buttons to select any undefined preset location.
5. Press {ENTER} once more. The display shows:

New Name = Sequence-##

6. On this page, you can rename the copied preset. The name of the copy defaults to the name of the sequence selected in step #1. You can now use the **Data Entry Slider** or the {VALUE} buttons to select various letters, numbers, and icons to create a name and use the {CURSOR} buttons to choose which character to edit.
7. When a new name has been written, press the {ENTER} button to complete the command. The display will briefly read “Command Successful!” to acknowledge the operation.

About the KT ROM Presets

The KT offers ten great-sounding and useful performance presets built into ROM.

To Select the ROM Presets

1. Press the {SELECT_SEQ/PRESET} button.
2. Press both the upper and lower {0} buttons.
3. If the top line of the display does not show **rPSET**, press the {BANK} button until it does.
4. Now press one of the lower {0} to {9} buttons to pick one of the ten presets.

Note: If the preset name ends with (i), it indicates that one or more sounds in that preset are “pointing to” i:INT internal sounds. If you edit an i:INT sound that is used by the preset, it may alter the characteristics of the preset. You can always return to the original presets by reinitializing the KT (explained in the *Introduction* of this manual).

The layers are designed for general playing purposes. Select them using the lower {0} and {1} buttons. The splits {2} through {8} provide a constant sound on the left half, and a selection of different sounds for the right. Preset {9}, a split designed for wedding ceremonies, features various organs on the left hand, and church bells on the extreme right.

List of ROM Presets

rPSET00 — MIDI-Blend

A layer of Dynamic Grand Piano (Track 1), Big Money Pad (Track 2), and Warm Syn & Tines (Track 3) that simulates a rich MIDI-based piano pad. This demonstrates how presets can be used for basic programming without getting deep into the world of programming. Track assignments are as follows:

1	2	3	4	5	6	7	8
Dynamic Grand	Big Money Pad	Warm Syn & Tines	Warm Syn & Tines	Warm Syn & Tines	Dynamic Grand	Dynamic Grand	Dynamic Grand
solid	flashing	flashing					

rPSET01 — OhSoSweet-Rhodes

A sweet-sounding electric piano layer made from Dyno Roads (for the basic electric piano), Inspiration (an octave higher for added presence), and Sparkle Pad (for added high-end shimmer). Track assignments are as follows:

1	2	3	4	5	6	7	8
Dyno Roads	Inspiration	Sparkle Pad	Dyno Roads	Dyno Roads	Dyno Roads	Dyno Roads	Dyno Roads
solid	flashing	flashing					

rPSET02 — AcBass/Kybrds(i)

A keyboard split consisting of Stand-up Bass on track 8 on the left side (A0 to E3), and a choice of up to 7 different instruments for the right side (F3 to C8). The Stand-up Bass remains constant, as does the keyboard split point as different “right hand” instruments (tracks) are chosen. Only a single click is required to select any of the other right hand instruments. Right hand instruments can also be layered with each other by double-clicking on their track buttons. Track assignments are as follows:

1	2	3	4	5	6	7	8
9' Grand Piano	Cool B-Three	Authentic 73	Studio Keys	Vibraphone	Piano & Strings	Nylon & Strings	Stand-up Bass
solid							flashing

rPSET03 — EIBass/Kybrds(i)

The same concept as above but with Woody Bass (electric bass guitar) on the left side of the split (same split point as preceding preset) and the same palette of “right hand” instruments. Track assignments are as follows:

1	2	3	4	5	6	7	8
9' Grand Piano	Cool B-Three	Authentic 73	Studio Keys	Vibraphone	Piano & Strings	Analog Pad	Woody Bass
solid							flashing

rPSET04 — SynBass/Kbds(i)

Another split with synthesizer bass on the left (A0 to E3) and a choice of up to seven right hand instruments. The left hand bass remains constant as different right hand instruments are selected (by pressing their Sequencer/Preset Track button). Track assignments are as follows:

1	2	3	4	5	6	7	8
Wheel Mute Clav	Studio Keys	Cool B-Three	Classic Roads	Pad Maker	Analog Pad	Big Money Pad	Syn-Sweep Bass
solid							flashing

rPSET05 — ElecBass/Gtrs(i)

This split features electric bass on the left (A0 to D3+) and a choice of up to seven guitar styles for the right hand. The left hand bass remains constant as different right hand instruments are selected. Track assignments are as follows:

1	2	3	4	5	6	7	8
Studio 6-String	Pedal Steel	Muted Guitar	12-String Guitar	Mellow Nylon	Studio Guitar	Nylon & Strings	Woody Bass
solid							flashing

rPSET06 — Pno/SoloHorns(i)

A split featuring a grand piano in the left hand (A0 to F4) and a choice of up to seven solo horn instruments in the right hand. Notice that the split point is higher here than on other presets. This provides the player with the ability to “comp” chords in the left hand using piano and solo over this with the right hand instrument. Alternately, two-handed piano playing is facilitated with the split point being at F4. As before, the left hand piano remains constant as different right hand instruments are selected. Track assignments are as follows:

1	2	3	4	5	6	7	8
Breathy Tenor	Muted Trumpet	Solo Trumpet	Solo Flugelhorn	Solo Trombone	Trump/Tenor/Bor e	Clarinet	KT Grand Piano
solid							flashing

rPSET07 — TinePno/Horns(i)

The same concept as above but with a tine piano (Track 8) on the left side of the split. The split remains the same as before (F4), with a selection of right hand solo instruments that complement the tine piano. As before, the left hand tine piano remains constant as different right hand instruments are selected. Track assignments are as follows:

1	2	3	4	5	6	7	8
Breathy Tenor	Muted Trumpet	Soprano Sax	Piccolo	Chiffy Flute	English Horn	Harmonica	Studio Keys
solid							flashing

rPSET08 — PnoStr/Orch (i)

This split features Piano & Strings for the left side (A0 to B3), and a selection of up to seven different orchestral instruments on the right side. The Piano & Strings sound remains constant as different right hand instruments are selected. Track assignments are as follows:

1	2	3	4	5	6	7	8
Orchestra	French Horn Sec	Oboe	Bassoon	English Horn	Clarinet	Concert Flute	Piano & Strings
solid							flashing

rPSET09 — Wedding Ceremony

This preset is designed for the organist for the traditional wedding ceremony. This preset is another split, with a number of organs and other appropriate sounds on the left, with church bells always on the far right. The bells have a key range of C6+ to C8. This track is always active, as is track 7 which contains the sound Heavenly Voices, with a key range of A0 to C6. The idea here is that track 7 is “layered” with whichever track (1 through 6) is selected, and Church Bells (track 8) are always available in the upper octave(s) by themselves (not layered with any sound). Tracks 1 through 4 contain different organ sounds which get progressively “fuller” with each new track. Concert Brass is on track 5 and Movie Strings is on track 6. These, just like the organs on tracks 1-4, can be selected without de-activating tracks 7 and 8, or they can be double-clicked to make a gigantic organ, choir voices, brass or strings layer. After all, you’ve got 64 voices to work with! Track assignments are as follows:

1	2	3	4	5	6	7	8
Principal Organ	Flute Stop Organ	Sunday Pipes	Pipe Organ	Concert Brass	Movie Strings	Heavenly Voices	Church Bells
solid						flashing	flashing

Section 9 — Preset/Track Parameters

This section offers detailed descriptions of the parameters available on the Edit track pages. These parameters affect preset, sequence, and song tracks. For an overview of the concepts involved, refer to *Section 8 — Understanding Presets*.

To edit any of the preset/track parameters described below, you must first press the {EDIT_TRACK} button. The {EDIT_TRACK} LED will light, indicating that the KT is in Edit Track mode. The {EDIT_SEQ/PRESET} LED will also light, as a reminder that Edit Track mode is a sub-mode of Edit Seq/Preset mode. In Edit Track mode, pressing the lower {0} to {9} buttons will view the appropriate Edit Track pages.

Edit Track

page 0 Vol/Pan

The top line of the display shows the bank location (i:INT, r:ROM, a:CARD, b:CARD), the preset, sequence, or song location, the track which is being edited, and the play status of the track. This line is the same on each page in Edit Track mode.

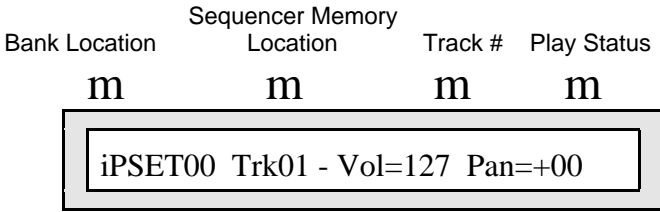

Vol Range: 000 to 127

The Volume parameter enables you to make volume changes to the individual tracks, allowing you to balance the KT sounds and/or control the volume of external MIDI devices.

All tracks whose MIDI Status is set to BOTH, MIDI, or *EXT* will send a MIDI Volume Change message (controller #7) with the indicated value whenever this parameter is edited. Sequence and preset tracks will also send the current volume for each track when a sequence or preset is selected.

Pan Range: -64 to +63

The Pan parameter gives you control over the placement of the track's sound in the stereo field. A Pan setting of -64 is hard left, and +63 is hard right.

When a track's Pan is set to +00, the voices of a sound are panned according to the settings originally programmed on the sound's Output page ({EDIT_SOUND} upper {7}, lower {3}) for each voice. Setting this parameter to any other pan value will override the original settings and will shift the voices of the sound toward the newly defined stereo-panned location.

iPSET01 Trk01 - Output=CONTRL-FX

Output

Range: DRY, FX1, FX2, VOICE, or CONTRL-FX

Normally, different voices in a sound are assigned to one of the three different busses, as set in the sound's Output page ({EDIT_SOUND} upper {7}, lower {2}). On this page, you can override the normal effects routing of the sound for each track. This may be useful when two sounds are split or layered in a performance preset, and the effect is not appropriate for both.

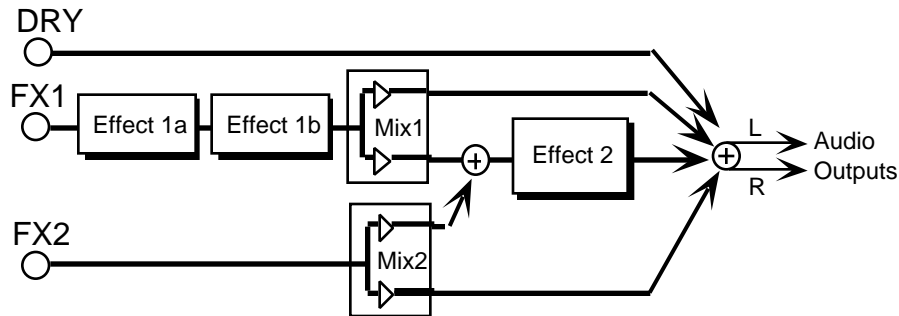

The available settings are:

- **DRY** forces all voices to the DRY bus
- **FX1** forces all voices to FX1
- **FX2** forces all voices to FX2
- **VOICE** uses normal voice routing as programmed in each sound.
- **CONTRL-FX** uses normal voice routing as programmed in each sound, and routes controller information from this track to the effect. This is the default setting when a new track is defined and/or when the Replace w/FX function is used to install a sound and its effect. This ensures that any pre-programmed effect modulation in a sound will still function. See *Section 3 — Understanding Effects* for more information.

KeyRange

```
iPSET01 Trk01 - KeyRange=C2 C8
```

i *i*
 Low Key High Key

KeyRange

Range: D#0 to F8

Each track has its own independent Key Range within which the track will play. Key ranges can be used to create simple two-sound splits, or to create more complex keyboard layouts. Key ranges control which keys will be sent out via MIDI as well as which keys will play the local voices of the KT.

You can divide the keyboard into as many as eight different key ranges by using the eight sequence/preset tracks. In addition, you can set the key range so that each range overlaps the next, producing “layered” ranges in which you would hear the sounds from more than one track.

The illustration below shows an example of three tracks with overlapping key ranges. The Piano is layered with, and partially overlaps, the Cellos on the lower end and the Flute on the upper end.

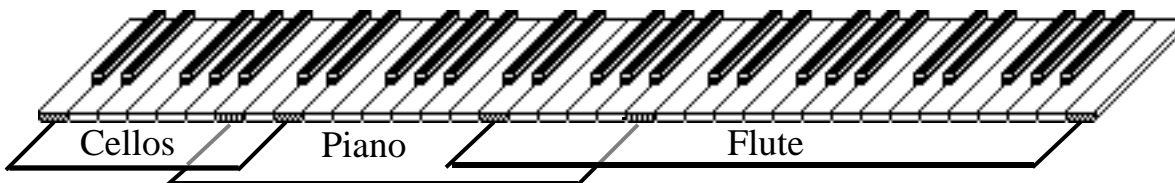
**To set a Key Range:**

1. Press {EDIT_TRACK}, then the lower {2} button. The Low Key value will flash.
2. Play the key on the keyboard that you want to be the lowest key of the range. The flashing will automatically move to the right for the High Key of the range.
3. Play the key for the highest key of the range. The new values for the range will be displayed and the flashing will stop.
4. If you want to reset the range, simply reselect this parameter and repeat the process.

Changing the key range will not affect the playback of sequencer tracks (though it does affect what is being recorded). Sequencer tracks will play all keys that were recorded, regardless of the key range at the time of playback. To eliminate notes within a key range from a sequence track, use the Erase Track command ({EDIT_SEQ/PRESET}, upper {5}, lower {2} button) and define the key range that you want to eliminate within the command. This is explained in more detail in *Section 11 — Sequencer Parameters*.

⚠ **Warning:** If the key range is set to where the High Key is below the Low Key, then the track will not play. To correct this situation, reselect the KeyRange parameter and reset the key range values.

Performance Tip — Creating Keyboard Splits

One of the most common uses of presets is a keyboard split, in which your left hand plays an “accompaniment” sound and your right hand plays a “solo” sound. This is easy to set up on the KT by layering the two sounds and assigning them different key ranges. You can save this arrangement as a preset so that any time you select that preset, you’ll recall the keyboard split.

Since each track in the keyboard split has its own Transpose value, you are not limited to bass notes on the piano just because it’s on the bottom of the keyboard. Just set the KeyRange to the keys you want to play, and then transpose the sound up or down until it’s playing in the range you want.

Once you have a keyboard split, you can change any of the sounds without affecting the split points by using the {REPLACE_TRACK_SOUND} button.

Edit Track

page 3

Transpose

iPSET01 Trk01 - Transpose=+0 +00

i
i
 Octave Semitone

Transpose

Octave Range: -4 to +4 octaves

Semitone Range: -11 to +11 semitones

The Transpose function provides a way to transpose tracks in real time without changing the data in the track. Each track can have its pitch transposed (raised or lowered) by octaves and semitones within an eight octave range. The transpose setting affects both the pitch played by local KT voices and the key number transmitted via MIDI. Note that this is completely independent of the {TRANSCOPE_KEYBOARD} button on the front panel.

Warning: Do not transpose a track whose status is MIDI or BOTH while holding keys down or while the sequencer is running. This could cause the MIDI key-up events to be missed by a receiving external MIDI device, causing notes to “hang.”

iPSET01 Trk01 - Chan=03 Prog=000

i

MIDI Channel

i

MIDI Program Number

Chan

Range: 01 to 16

Use this parameter to determine which MIDI channel a track will use to transmit and receive data. The difference in how this parameter controls the track for transmitting and receiving is important to understand. You may wish to refer to the sections covering System•MIDI and Sequencer Applications.

Transmit Controls which channel the selected track of a preset will send data on. MIDI data will be transmitted only if the selected track has a MIDI Status of BOTH, MIDI, or *EXT* ({EDIT_TRACK} lower {5}).

Receive Controls which channel an individual sequencer track will receive data on if MIDI Mode=MULTI or MONO B is selected on System•MIDI, page 6.

In POLY or MONO A modes, the KT will receive only on the Base MIDI channel no matter which track, combination of layered tracks, sound, or preset is selected. Individual preset tracks will not receive on different MIDI channels. For presets, this becomes a send-only function.

Warning! If MIDI Mode=MULTI or MONO-B on System•MIDI page 6, and more than one track is set to receive on the same MIDI channel, only the lowest numbered track will receive via MIDI.

Prog

Range: 000 to 127

This parameter lets you choose which MIDI Program Change number will be transmitted via MIDI when the track is selected. If the track MIDI status has been set to LOCAL, the track will not send program changes. When a different Track, Preset, Sequence or Song is selected, the KT will transmit MIDI program change messages for tracks with a status of BOTH, MIDI or *EXT*.

The default program change number is the number of the KT sound assigned to the track. This number is automatically set whenever a sound is selected for a track. Assigning a new sound to a Preset track with the {REPLACE_TRACK_SOUND} button automatically updates the program change number to that of the new sound on the track.

You can set this number to any other legal program number if you wish to override the default value. Editing this number will change programs on external MIDI devices without changing the current KT sound. This is a convenient way to try out combinations of KT sounds and external MIDI devices.

Program Changes in the KT

The sounds in all banks are assigned MIDI Bank Select numbers and program numbers. The KT's **MIDI Out** will send the appropriate MIDI Bank Select message whenever the bank (i:INT, r:ROM, a:CARD, or b:CARD) is changed.

- Internal RAM sounds (i:INT banks) are numbered from 001 to 079.
- r:ROM sounds are also numbered from 001 to 079.
- Card sounds (a:CARD or b:CARD banks) are numbered from 001 to 079.
- The r:DRUM ROM sounds are numbered from 080 to 099.

Bank Select and Program Change Implementation

The way the KT receives program changes is slightly more complex than some other systems, because the number of sounds that are available to be selected from MIDI is larger than the number of program change messages available within the MIDI standard. To solve this problem, the KT uses MIDI Bank Select numbers (LSB 0 to 3) to control how subsequent program changes will be interpreted. The following chart shows the effect of these four Bank Select messages:

After MIDI Bank Select:	Subsequent program changes will select:
LSB 0	000..079 - i:INT sounds
LSB 1	000..079 - r:ROM sounds
LSB 2	000..079 - a:CARD sounds
LSB 3	000..079 - b:CARD sounds

These MIDI Bank Select values need to be sent only once. All subsequent program changes will be directed to the Bank that was selected by the last Bank Select message received.

Note: Incoming Program Changes 80 to 99 will always select one of the 20 r:DRUM ROM Sounds.

Selecting a New Sound and its Effect from MIDI

There is a special range of MIDI Bank Select messages, recognized only in MULTI mode, that are used to select both a sound and its effect for one of the eight sequencer tracks. When Bank Select value +10 is received on a channel assigned to a sequencer track, then the next program change received on that track will select a new sound and will also install the effect from that sound as the new sequence (or song) effect. This can be useful when controlling the KT from an external sequencer.

After MIDI Bank Select:	Subsequent program changes will select:
LSB 10	000..079 - i:INT sounds with its effect
LSB 11	000..079 - r:ROM sounds with its effect
LSB 12	000..079 - a:CARD sounds with its effect
LSB 13	000..079 - b:CARD sounds with its effect

iPSET01 Trk01 - Status = BOTH

Status

Range: BOTH, LOCAL, MIDI, or *EXT*

This page determines the MIDI Status of a track. The four possible settings are:

- BOTH** Keys, controllers, etc., will play KT voices and will be sent via MIDI on the selected MIDI channel. Incoming MIDI will play KT voices.
- LOCAL** Keys, controllers, etc., will only play KT voices, and will not send any data out via MIDI. Incoming MIDI will play KT voices.
- MIDI** Keys, controllers, etc., will be sent out via MIDI when the track is played from the keyboard. However, keys played or recorded on the track will not play KT voices. Incoming MIDI will play KT voices. This is comparable to Local Off on some keyboards. Use this status when you want to create MIDI-only tracks for sequencing or playing remote MIDI devices. When MIDI status has been selected for a track, instead of showing the program name, the display will show “*MIDI-CHAN-#,” indicating its status and what MIDI channel it is sending on (assuming MIDI-TRK-NAMES=OFF on System•MIDI page 9; see *Section 2 — System•MIDI*).
- *EXT*** Same as MIDI status except that incoming MIDI will not play internal voices. This is useful when using the KT as a Master MIDI Controller with an external sequencer and a number of other remote MIDI devices. It is also good for turning off certain tracks when using the KT as a multi-timbral receiver in MULTI mode, thereby limiting the number of MIDI channels to which the KT will respond.

This chart details the behavior of sequencer tracks for each MIDI Status:

Track Status	BOTH	LOCAL	MIDI	*EXT*
Playing the keyboard plays KT voices	YES	YES	NO	NO
Playing the keyboard sends out MIDI	YES	NO	YES	YES
Playing the keyboard will be recorded by the sequencer	YES	YES	YES	YES
Incoming MIDI data plays KT voices	YES	NO	YES	NO
Incoming MIDI data will be recorded by the sequencer	YES	YES	YES	*
Playing the sequencer track (pressing {PLAY}) plays local voices	YES	YES	NO	NO
Playing the sequencer track sends out MIDI	YES	NO	YES	YES

* NO in MULTI or MONO-B modes, YES in OMNI, POLY, and MONO-A modes.

iPSET01 Trk01 - Pressure=CHANNEL

Pressure

Range: NONE, KEY, or CHANNEL

This parameter enables you to assign one of three pressure types to each Track. This parameter controls which pressure type a track will respond to via MIDI. This parameter also enables and disables track pressure transmission to both KT sounds, and to external MIDI. Remember, the KT keyboard itself can only generate channel pressure, but it can receive both channel and Poly-Key pressure via MIDI.

When Pressure=NONE:

- Voices played from the keyboard or the sequencer will not respond to pressure.
- The sequencer will not record pressure into any tracks you record.
- The sequencer will not play back any Poly-Key or channel pressure messages recorded on the track.
- The instrument will not transmit or receive pressure of either type via incoming MIDI.

Note: You should select Pressure=NONE whenever you don't want or need pressure for a given sound, particularly when sequencing. Pressure data uses up sequencer memory rapidly, so whenever you record a track with a sound that doesn't respond to pressure, set this parameter to NONE. This will avoid wasting valuable sequencer memory, and will avoid clogging up the MIDI data stream with a lot of unnecessary pressure information. Existing pressure information can also be removed from a track using Filter Events on Edit Seq/Preset page 57.

When Pressure=KEY:

- Voices played from the KT keyboard will not respond to pressure.
- The sequencer will record Poly-Key pressure received via incoming MIDI into any tracks you record.
- The sequencer will play back any Poly-Key pressure messages recorded on the track, and will ignore any channel pressure on the track.
- The KT keyboard will not transmit any pressure out via MIDI; however,
- Either channel pressure or Poly-Key pressure will be received via incoming MIDI.

When Pressure=CHANNEL:

- Voices played from the KT keyboard will respond to channel pressure only.
- The sequencer will record channel pressure into any tracks you record.
- The sequencer will play back any channel pressure messages recorded on the track, and will ignore any Poly-Key pressure on the track.
- The KT keyboard will only transmit channel pressure out via MIDI, however.
- Either channel pressure or Poly-Key pressure will be received via incoming MIDI.

Note: The KT sequencer will always record both channel and Poly-Key pressure (received via incoming MIDI), no matter what the Track Pressure parameter is set to.

You should consult the MIDI implementation chart of the MIDI device you will be using with the KT to see which (if any) type of pressure it responds to and transmits. For best results, set the KT Pressure parameter to match the type of pressure supported by the external MIDI device that will send to or receive from the track you are setting.

Edit Track

page 7

Sustain Pedal

iPSET01 Trk01 - SustainPedal=ON

Sustain Pedal

Range: OFF or ON

Allows you to determine whether each individual track will respond to sustain controller events. The effect of all sustain events, whether from the KT sustain pedal (FtswR=SUSTAIN on {SYSTEM"MIDI}, page {2}) or sustain commands received from MIDI (controller #64), is controlled by this switch.

- ON — sustain events will affect all notes played within the active key range for this track.
- OFF — sustain events will have no effect on the notes played on this track.

For example, it may be useful to turn off sustain events on a track set up as a bass sound in a split keyboard configuration. This allows you to play staccato bass lines on the lower part of the keyboard, while playing chords on the upper part of the keyboard and using the sustain pedal. The bass notes will not be affected by the sustain pedal (because the bass track sustain is set to OFF) but the chords will sustain.

Edit Track

page 8

Timbre

```
iPSET01 Trk01 - Timbre = 000
```

Timbre

Range: 000 to 127

Timbre provides an easy way to make useful changes to the character of a sound without getting into more complex programming. This performance parameter uses the **Data Entry Slider** and {VALUE} buttons to control various aspects of the sound, depending on what the programmer has decided would be useful.

As a voice modulation source, Timbre can be assigned to anything that can be modulated in a program or effect. The Timbre control can be connected to parameters such as filter cutoff, waveform modulation, LFO depth, and others. It is a good idea to experiment with the Timbre setting to hear what it has been programmed to do in each program.

All tracks whose MIDI Status is set to BOTH, MIDI, or *EXT* or will send a MIDI Continuous Controller message (controller #71) with the indicated value whenever this parameter is edited.

Edit Track

page 9

Release

```
iPSET01 Trk01 - Release = +00
```

Release

Range: -64 to +64

“Release” is the time it takes for the sound to fade away when the key is released. This parameter enables you to increase or decrease the release time of the sound on a selected track. It is useful when you need to adjust the release characteristics of a sound for a particular application without getting more deeply into programming. Higher values lengthen the release time, whereas lower values shorten the release time.

All tracks whose MIDI Status is set to BOTH, MIDI, or *EXT* will send a MIDI Continuous Controller message (controller #72) with the indicated value whenever this parameter is edited.

Section 10 — Understanding the Sequencer

This section contains an introduction to the KT sequencer and all the information you'll need to start sequencing.

If you've turned here first because you can't wait to start sequencing, you should turn back to *Section 8 — Understanding Presets*. The Presets section contains important information on choosing and playing tracks, setting performance parameters and MIDI controls, that is integral to the sequencing process. We recommend that you read that section first, then come back and familiarize yourself with the many other sequencer controls and functions described in this section. This is the only way to truly take advantage of the power of the KT sequencer.

Digital Sequencing

Multi-channel audio tape recorders have many physical tape tracks onto which you can magnetically record complex polyphonic information. Digital sequencers simulate this by recording events that describe a performance onto virtual tracks in computer memory. When these sequence tracks are played back, the recorded information can play KT sounds or can be sent to remotely controlled sound generators to recreate the performance. A digital sequencer records and plays back the “control information” rather than the actual notes. This means that there is no degradation of the sound in the recording process no matter how many times you overdub or re-record a part.

It is important to bear in mind that a sequencer only records what you play. Sequencer memory is used up by Events (keys struck, controllers, etc.), while a tape recorder's memory (the tape) is always used up by the same amount over a fixed period of time.

This means that a digital sequencer will use virtually the same amount of memory to record 100 notes, whether you play those notes over ten seconds or ten minutes. When you strike a key, the sequencer records a Key Down event. It then counts the clock pulses until you release the key, when it records a Key Up event. The amount of time between the key down and the key up doesn't really affect the amount of memory required to record the note. Compare this to an audio tape recorder. With tape, time is the important factor. A tape recorder will use the same amount of tape to record a minute of music, whether the signal contains one note or one hundred.

You might say that tape is linear — it is spent at a fixed rate — while digital sequencer memory is dynamic — it is used only as needed. Understanding the difference will help you to manage the KT sequencer memory. For example, while key events (the notes you play) use up relatively little memory each, controllers such as mod wheel, pressure, etc., are recorded as a flood of numbers that can fill the memory quickly. So if you're trying to squeeze one more track into a sequence when there isn't much memory left, you know to go easy on the controllers.

What is a Sequence?

A sequence is simply a piece of music recorded by the KT. Each sequence can contain up to eight independent performances (along with an effects algorithm and its settings) — using eight different sounds — playing together to produce a complete musical arrangement. Each one of these performances is called a “track.” Each track has its own set of track parameters (volume, pan, and all the other performance parameters, including MIDI channel, status, etc.) that are remembered with the sequence.

A sequence has a fixed length (though you can change it at any time) that is set by the length of the first track you record. A given sequence can be as short or as long as you like (within the limitations of memory). Each sequence has a 16-character name that is assigned at the time of its creation, but the name can be changed at any time (press {EDIT_SEQ/PRESET}, the top {4}, then the bottom {4}).

When you select a new sequence, each track used within that sequence will send out a MIDI program change and MIDI volume instructions on its designated MIDI channel, unless the track has been assigned LOCAL only status.

What is a Song?

A KT song is a collection of sequences programmed to play one after another. When a song is selected, individual sequences are assigned to play in a certain order as a series of Steps with up to 99 Steps, and up to 99 Repetitions of each Step. Within each Song Step, individual tracks within the sequence can be muted or transposed.

However, a song on the KT is much more than just a collection of sequences playing in order. This is because each song has an additional set of eight tracks that are completely independent of the tracks in its component sequences.

Each Song Track can have its own sound and a full set of track/performance parameters, just like a sequence track. The length of the song tracks is defined by the combined length of the sequence steps and repetitions which make up the song. Song tracks are selected with the {SEQUENCER/PRESET_TRACK} buttons when a song is selected.

This means that after you have completed some sequences and linked them together to form a song, you have eight more linear tracks that run the entire length of the song. This gives you a total of 16 tracks to work with (for more information, see “Song Tracks” later in this section).

About Sequencer Memory

There are four banks of 70 Presets/Sequences and 30 Songs, each available in the KT (i:INT (RAM), r:ROM, a:CARD and b:CARD):

- i:INT — 70 Presets/Sequences and 30 Songs can be stored in the KT Internal RAM Memory (Random Access Memory). The i:INT sequencer bank contains room for 6500 events.
- r:ROM — Additional Presets/Sequences and Songs are permanently stored in ROM (Read Only Memory). Like the Internal (i:INT) sequencer data the ROM sequencer data is contained within the KT; but unlike the Internal (i:INT) sequencer data, it cannot be modified or replaced. The Demo Song is found in r:ROM page location 70.
- a:CARD and b:CARD — 140 Presets/Sequences and 60 Songs can be stored in an industry-standard PCMCIA card (70 Presets/Sequences and 30 Songs in group A, and 70 Presets/Sequences and 30 Songs in group B) when it is plugged into the card slot.

Card Sequencer Memory

ENSONIQ MC-512 RAM Cards (or any PCMCIA RAM card) can be used to store two banks of 80 Sounds (which we refer to as a:CARD and b:CARD), and two banks of 100 Presets/Sequences/Songs (also a:CARD and b:CARD). The 100 Presets/Sequences/Songs available on RAM cards are divided into 70 Presets/Sequences and 30 Songs, just like in the KT (i:INT and r:ROM).

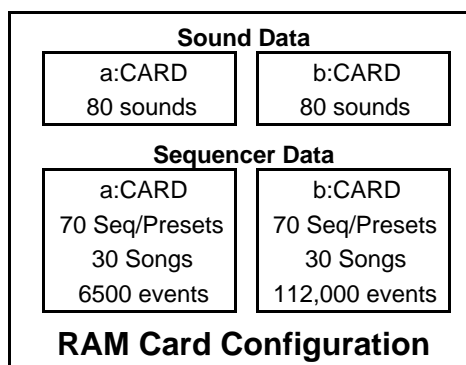

Both sounds and sequencer data stored to a PCMCIA RAM card can be played directly from the card (when it's properly inserted into the card slot on the KT). Each Preset/Sequence/Song bank is a world unto itself: for example, songs can only be constructed of sequences from the same bank. The Preset/Sequence/Song banks are sized as follows:

- The a:CARD Preset/Sequence/Song bank is formatted to exactly the same size as the i:INT Preset/Sequence/Song bank. It is used mainly for portable backup of the i:INT, and as a transfer area. The a:CARD sequencer bank contains room for 6500 events.
- The b:CARD Preset/Sequence/Song bank is formatted to use all remaining card space assigned for sequencer data storage. The b:CARD sequencer bank contains room for 112,000 events. This is for your big projects. b:CARD stands for BIG!

ROM Preset/Sequence/Song reside permanently in the KT and cannot be edited. Most of the sequencer commands are “locked out” when a ROM Preset/Sequence/Song is selected. However, you can copy any ROM Preset/Sequence/Song into RAM (i:INT) or to a card and edit it there.

Note: If the sequencer is playing or recording into a card bank (a:CARD or b:CARD) and you pull out the card, the KT will restart as though the power was turned off and on. This will also happen if the sequencer is stopped, and the audition page is displayed for sequencer data on either card bank.

Sequencer “Transport Controls”

The three buttons at the bottom of the Sequencer section are used to start, stop and continue the sequencer, and to put it into Record and Overdub modes. Besides these three buttons, either the basic single damper foot switch (SW-6) or a dual foot switch (the optional SW-10) can be used to start and stop the sequencer when both hands are busy (see *Section 2 — System•MIDI Parameters*).

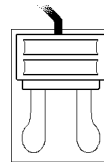
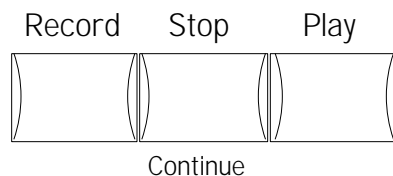

SW-10 Dual Foot Switch

Assuming the Auto Punch function is off (see the description of the Auto Punch parameter in *Section 11 — Sequencer Parameters*):

- Press {PLAY} to start the current sequence or song (whichever is selected) from the beginning.
- Pressing {STOP"CONTINUE} while the sequencer is running will stop the current sequence or song.
- Pressing {STOP"CONTINUE} while the sequencer is stopped will play the current sequence or song from wherever it was last stopped.
- Either foot switch can duplicate the behavior of the {STOP"CONTINUE} button by setting FtswL or FtswR=STOP/CONT on System•MIDI page 2.

Note: If you are using a single foot switch (SW-2 or SW-6) in the Foot Switch jack, the FtswL parameter on System•MIDI page 2 should always be set to UNUSED. This will prevent note drones. Remember that the **Foot Switch** jack is optimized for use with a stereo Foot Switch (SW-10). When a single foot switch is connected, it behaves like the right foot switch (FtswR).

- While holding down {RECORD}, pressing {PLAY} will start the sequencer recording on the current track from the beginning of the sequence or song.
- While holding down {RECORD}, pressing {STOP"CONTINUE} will start the sequencer recording on the current track from wherever it was last stopped.
- Pressing {RECORD} while the sequencer is playing will put the sequencer into “overdub” mode. It will wait for you to start playing before going into Record on the current track.

Sequencer Status

On many sequencer pages the upper right-hand corner of the display indicates the Sequencer Status. The sequencer is always in one of the following states:

STOP	Sequencer at rest.
PLAY	Playing current sequence (sequence selected).
SNGS	Song Stop: sequencer at rest with a song selected.
SNGP	Song Play: playing current song.
REC	Recording on current track, first pass.
ODUB	Overdub: re-recording current track.
play	Countoff playing before going into Play, Record or Overdub.
rec	Record Standby: waiting for you to play before going into Record (first track only).
odub	“Overdub” Standby: waiting for you to play before going into Overdub.
mrec	MIDI sync Record Standby: same as Record Standby except that the sequencer is synced to external MIDI clocks (CLOCK=MIDI on the Control page) and is waiting for MIDI clocks before going into Record.
AUDP	Audition Play. This state is entered automatically from Record when the end of the sequence is reached (assuming LOOP=ON). After leaving Record and entering Audition Play, the sequence will continue to play in this state, with the newly recorded track, until you press the {STOP"CONTINUE} or {SAVE} buttons. The Display will then show “Press ENTER to keep NEW track.”
AUDS	Audition Stop is entered when you stop the sequencer from the Audition Play state. To exit Audition Stop and return to the normal stop state, you must first instruct the KT to KEEP either the NEW or the original OLD track (see KEEP NEW/OLD screen later in this section).

Select Sequence Mode Pages

Pressing the {SELECT_SEQ/PRESET} button puts the KT into Select Sequence/Preset mode. Repeatedly pressing the {BANK} button will scroll through the different sequencer memory banks: i:INT (RAM), r:ROM, a:CARD, or b:CARD. The {0} to {9} buttons will now select Sequence/Preset or Song pages. Pages 00 to 69 contain sequences/presets, while pages 70 through 99 hold the songs. Each page contains a sequence/preset or song location that can be selected by pressing an upper {0} to {9} button for the first digit, and then a lower {0} to {9} button for the second digit.

Location of sequence

m m

iSEQ 00 Tempo120 Seq/Preset-00

i

Name of sequence/preset

Preset/Sequence Locations 00 to 69 that have not yet been defined show:

Press ENTER to Make new Pset=##

i

empty location selected

Song Locations 70 to 99 that have not yet been defined show:

Press ENTER to Make new Song=##

i

empty location selected

- Pressing {ENTER} will initiate the Make new Preset or Make new Song function (see Creating a New Sequence or Song, later in this section).
- Pressing {NO} will redisplay the name page for the currently selected Preset/Sequence/Song.

Selecting a Sequence or Song

1. Press the {SELECT_SEQ/PRESET} button to enter Select Sequence/Preset mode.
2. Repeatedly press the {BANK} button to select the appropriate bank.
3. Press a top {0} to {9} button to select the first digit of the Sequences/Presets and Song page.
4. Press a bottom {0} to {9} button to select the second digit of the page.

Choosing Internal, ROM, and Card Sequences/Presets/Songs

In Select Sequence/Preset mode, the display shows the bank and page location, and the name of the Sequence/Preset or Song:

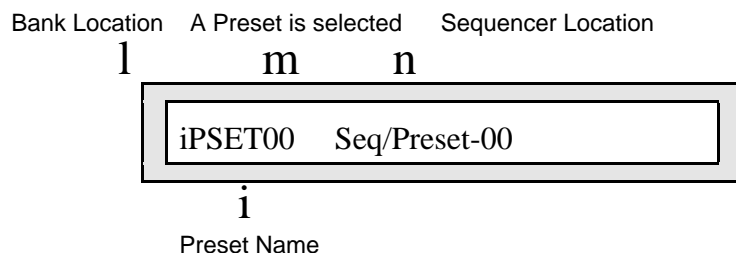

There are two methods that can be used to choose between the four banks:

- The {BANK} button — Repeatedly pressing the {BANK} button will step through the various banks. The bank location in the upper left corner of the display will change.
- Direct-Dialing — You can reach any of the banks directly by pressing the {BANK} button, and while continuing to hold the {BANK} button down, press one of the lower {0} to {3} buttons.

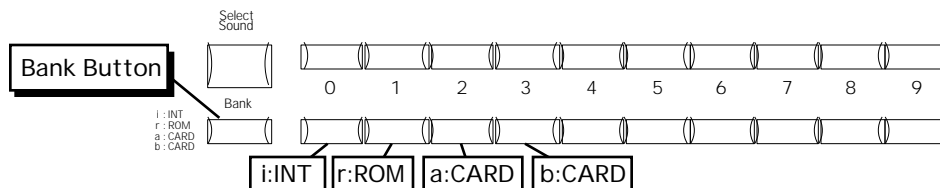

The lower {0} to {3} buttons are used to choose between i:INT, r:ROM, a:CARD and b:CARD sequence/presets/songs. Note that if there is no card installed, or there is no sequencer data on the card, the a:CARD and b:CARD banks will not be recognized.

Playing Sequences and Songs

Try selecting a sequence, and pressing {PLAY}. The selected sequence will begin to play.

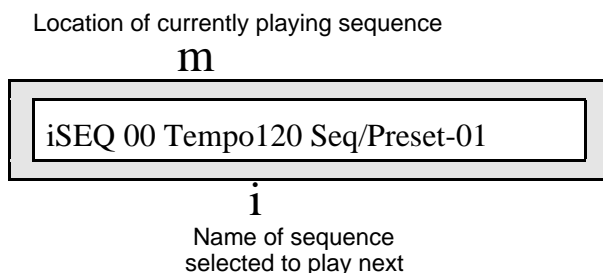

While one sequence is playing, you can select another one. The bottom line of the display will show the name of the new sequence, with the original sequence continuing to play. When the first sequence is finished, the upper left hand corner of the display will switch to indicate the new sequence, and it will play. This is how you can string sequences together in real time, as they play. The display always shows you which is playing (upper left corner) and which is selected to play next (bottom line).

Note: If the new sequence uses a different effect algorithm than the previous one, the audio output will be muted temporarily while the new algorithm is loaded. See *Section 3 — Understanding Effects* for more information on effect algorithms.

Creating a New Sequence or Song

To Create a New Sequence:

1. Press the {SELECT_SEQ/PRESET} button to enter Select Sequence/Preset mode.
2. Press the {BANK} button until the upper left corner of the display shows either iPSET, aPSET, or bPSET. Remember, you can't create a sequence/preset in r:ROM (Read Only Memory).
3. Using the {0} to {9} buttons, select any undefined sequence location (pages 00 to 69). Remember, pages 00 through 69 contain sequences, and 70 through 99 contain songs. When you select an undefined location, the display will show the following prompt:



Press ENTER to Make new Pset=##

i

currently selected location

4. Press the {ENTER} button. The display shows:



New Sequence Location = ##

The **Data Entry Slider** or the {VALUE} buttons will now scroll through all available unused sequence locations within that bank (when creating a song, the Data Entry Controls scroll through unused song locations).

Once a location has been chosen, press {>} or the {SAVE} button. The display shows:



Time Signature = 04/4

6. The {VALUE} buttons will now set the time signature values. The {>} or the {ENTER} button will advance to the second value. Pressing the {>} or the {ENTER} button a second time will cause the display to show:



New name = Seq/Preset-##

7. Again, use the **Data Entry Slider** or {VALUE} buttons to select various letters, numbers, and icons to create a name and use the {CURSOR} buttons to choose which character to edit.
8. Now that you've selected a location, time signature, and name for your sequence, press the {ENTER} button again. The display will briefly read "Command Successful!"

To Create a New Song:

1. Press the {SELECT_SEQ/PRESET} button to enter Select Sequence/Presets mode.
2. Press the {BANK} button until the upper left corner of the display shows either “i” (for i:INT), “a” (for a:CARD), or “b” (for b:CARD). Remember, you can't create a song in r:ROM (Read Only Memory).
3. Press any top row button from {7} to {9} to select the song locations.
4. Using the lower {0} to {9} buttons, select any undefined song location (pages 70 to 99). Remember, pages 00 through 69 contain sequences, and 70 through 99 contain songs. When you select an undefined location, the display will show the following prompt:

Press ENTER to Make new Song=##

i

currently selected location

5. Press the {ENTER} button. The display shows:

New Song Location = ##

6. The **Data Entry Slider** or {VALUE} buttons will now scroll through all available unused song locations (when creating a sequence the arrows scroll through unused sequence locations). Once a location has been chosen, press {>} or the {SAVE} button. The display shows:

New name = Song-##

7. Again, use the **Data Entry Slider** or {VALUE} buttons to select various letters, numbers, and symbols to create a name and use the {CURSOR} buttons to choose which character to edit.
8. Now that you've selected a location and name for your song, press the {ENTER} button again. The display will briefly read, “Command Successful!”

Erasing All Sequencer Memory

When you want to erase all sequences and songs in the currently selected sequencer bank, first make sure you have saved any important data to a storage card or to a remote MIDI device using MIDI system exclusive, then:

1. If not currently in Edit Sequence/Preset mode, press the {EDIT_SEQ/PRESET} button. The LED in the button will light.
2. Select the Sequencer Control pages by pressing the upper {1} button.
3. Press the lower {7} button. The display shows:



Press ENTER to Erase Seq Memory

4. Press {ENTER}. The KT display shows:



Erase Seq Memory in Bank xxxxxxx ?

This read-only page displays the selected bank to be erased.

5. Press the {YES} button. The KT erases all presets, sequences, and songs from the selected sequence/preset bank. This will not erase any sounds used by the sequencer. After the memory is erased, there will be one blank sequence and one blank song in locations 00 and 70 respectively (there is always one song and one sequence in memory).
- Note that when a ROM Sequence/Preset/Song is selected, this command cannot be performed, and the display will momentarily show “Cannot edit ROM!”

Recording a Sequence

Here we will describe recording a new sequence from scratch. First we will concentrate on sequencing with the KT alone, and then cover sequencing remote MIDI instruments.

Create a New Sequence:

1. Following the steps outlined earlier in this section, create a new sequence/preset.
2. Press a {SEQUENCER/PRESET_TRACK} button. The display will now read:

Selected Seq/Preset Track	Sound Bank Location	Sound Page Location
1	m	n
Trk01 i:INT 00 <Sound Name>		
i		
Track Sound Name		

Note that if there was any data on the track, there would be an 1/8th note symbol following the Selected Seq/Preset Track number on the top of the display.

Select a Track:

1. Track 1 is already defined and selected (there is always one track selected in a sequence) and the current sound has been placed on the track. All other tracks are still -UNDEFINED-.
2. To begin recording the sequence with a track other than Track 1, press the {SEQUENCER/PRESET_TRACK} button corresponding to that track. This defines the track and puts the currently selected sound on it. Otherwise, you can just leave Track 1 selected and start from there.

Select a Sound for the Track:

1. Press the {REPLACE_TRACK_SOUND} button.
2. Select a sound as you normally would, using the {BANK} and {0} to {9} buttons to locate the sound you want. Each new sound is assigned to the track, replacing the previous one.
3. Press {REPLACE_TRACK_SOUND} again to exit Replace Track Sound mode, placing the currently displayed sound on the track.

Check the “Click” and “Countoff” settings:

1. Press {EDIT_SEQ/PRESET}. Go to the Click page by pressing the upper {2} button, followed by the lower {0} button. This page controls the functions of the KT’s internal metronome. Select the “Click” parameter and set to “Click = RECORD.” This will provide a click track when you are in record, but not during playback.
2. Select the Countoff page by pressing the upper {1} button, then the lower {0} button. Select the “Countoff” parameter and set to “Countoff= RECORD”. This will play a one bar countoff before recording (but not when playing back) all tracks.

Record the First Track:

The length of the first track defines the length of the sequence. So, there is a special procedure for recording the first track of a new sequence:

1. While holding down {RECORD}, press {PLAY}. The click track starts playing, giving the tempo. The first beat of each measure is accented. The tempo parameter on the Click page is automatically selected.
2. Adjust the Tempo. Use the **Data Entry Slider** or the {VALUE} buttons to set it to the tempo you want. The bar in which you start playing becomes Bar 1 of the Sequence.
3. Press {STOP"CONTINUE} to end recording. Note that the foot switch can be used to stop recording, when set to STOP/CONT on System•MIDI page 2. The display will show:

Trk01 Keep first XXX bars?

This will determine the length of the sequence.

4. Press the {YES} button to keep the track, defining the length of the sequence, or
5. Press the {NO} button to erase the first track and start over, leaving the sequence length undefined.

Record Additional Tracks:

After you have answered YES to the question “Trk1 Keep first ## bars?” all other recording, including re-recording the first track, will follow the same basic routine. The length of the sequence is now defined (by the length of the first track). The rest of the sequence tracks will automatically have the same length.

1. Press the second {SEQUENCER/PRESET_TRACK} button, and select a second track (or leave the first track selected if you want to record over it). The name of the program and all the track parameters from the previous track are copied onto to the new track.
2. Select a sound for the track using the {REPLACE_TRACK_SOUND} button, as described earlier, to put the sound of your choice on the selected track.
3. While holding down {RECORD}, press {PLAY} to begin recording. The click track will play for one measure (assuming Countoff=RECORD or CLICK) and then the sequencer will enter record mode. It will record whatever you play on the new track until:
 - the end of the sequence is reached, or
 - you press {STOP"CONTINUE} (or press the foot switch when set to STOP/CONT on System•MIDI page 2).
4. At the end of the sequence, the KT will leave record mode and (assuming Loop=ON) enter Audition Play mode. At that time, the Keep NEW/OLD page is shown:

Press ENTER to KEEP NEW TRACK

5. Press the {NO} button to hear the track as it was before you recorded the new track. The display then reads “OLD” where it shows “NEW” in the above illustration. This is invaluable when you begin to do second and third takes, since it allows you to compare the tracks before deciding which to keep.
6. Press the {} button to hear what you just recorded.
7. Press the {ENTER} button while the display reads “OLD” to leave the track as it was in memory, and “trash” the one you just recorded. If the track was empty before recording, pressing {ENTER} will leave it empty.
8. Press the {ENTER} button while the display reads “NEW” to save the new track into memory, replacing whatever was on the track before.

The KEEP NEW/OLD Page

The Keep NEW/OLD page appears after all track recording and after most track command functions. The KT always gives you a chance to audition changes to the track data before deciding whether to keep them. You’ll find this capability to be of great use for those occasions when you need to hear both versions back-to-back to make a decision.

Re-recording a Track

The KT offers two methods for re-recording (or “punching in”) a specific part of a track. When the Auto Punch function is OFF, you can punch in manually just by playing the keyboard to start recording. When Auto Punch is ON the KT will enter and exit Record mode automatically at the precise times that you specify on the Locate page (see the description of the Locate and the Auto Punch parameters in *Section 11 — Sequencer Parameters*).

To Punch In manually on a track (Auto Punch=OFF on Sequencer Control page 2):

1. Press the {EDIT_SEQ/PRESET} button, the upper {0} button, then the lower {0} button.
2. Press the {SEQUENCER/PRESET_TRACK} button to select the track you want to record on.
3. Press {PLAY} to start the sequence or song playing.
4. Press {RECORD}. This puts the KT in Overdub Standby — “odub” appears in the upper right corner of the display and the sequencer waits for you to play keys before going into record.
5. Start playing at the point where you want to punch in. When you play anything, the KT goes into overdub (or record for a new track) and records what you play, leaving intact the part of the track before the punch in. Unless you then press {STOP"CONTINUE}, new track data will be recorded from the point where you punched in to the end of the sequence or song.
6. Press {STOP"CONTINUE}. You will see the Keep NEW/OLD page as shown earlier, letting you audition the new or the old track before deciding which to keep.

To Punch In and Out automatically on a track (Auto Punch=ON):

1. Press the {EDIT_SEQ/PRESET} button, the upper {0} button, then the lower {3} button.
2. Set “Auto Punch = ON” with the **Data Entry Controls**.
3. Press the lower {1} button, and use the **Data Entry Controls** to define the exact bar, beat and clock at which the KT will enter record.
4. Press the lower {2} button, and use the **Data Entry Controls** to define the exact bar, beat and clock at which the KT will exit record.
5. Press the {SEQUENCER/PRESET_TRACK} button to select the track you want to record on.
6. While holding down {RECORD}, press {PLAY} to start the sequencer. It will begin to play, but will not go into record until the Punch In time is reached. You can play along with the sequence if you wish without being recorded.
7. When the Punch In time is reached, the sequencer will automatically enter record, and will record whatever you play until the Punch Out time is reached.
8. At the Punch Out time, the sequencer automatically exits record and goes into Audition mode.
9. Audition the new track as usual from the Keep NEW/OLD page before deciding whether to keep the new or the old track.

When AutoPunch=ON, the KT will record events only within the window of time specified by the Edit times, no matter how you enter record. Thus, if you press {PLAY} then {RECORD}, the KT will wait for you to play before entering record, but recording will only be triggered by notes within the Edit times window. Notes played before the Punch In time or after the Punch Out time will not initiate recording.

If Record = LOOPED (on Sequencer Control page 1) and AutoPunch=ON, the sequencer will continue to go in and out of record at the Edit times each time the sequence repeats, for as long as you let it play.

Tip: When the foot switch is set to control sequencer STOP/CONT, depressing the foot switch while the sequencer is running in Overdub Standby mode (lower case “odub”), forces the sequencer into Overdub Record mode (upper case “ODUB”). This allows for hands-free punch ins without using punch times.

Playing along with a Sequence/Auditioning New Sounds and Effects

In Select Sequence/Preset mode, you can play a multi-timbral lead along with sequencer playback by double-clicking (layering) the {SEQUENCER/PRESET_TRACK} buttons.

The preferred way to audition new sounds, or to just play along while the sequencer is running, is to use the {REPLACE_TRACK_SOUND} button, as described in *Section 8 — Understanding Presets*.

Tip: When a sequence is playing, pressing {SELECT_SOUND} will load the effect algorithm for the current sound into the effects processor, replacing the sequence effect. This does not change the sequence; but by selecting different sounds, you can audition the sequence with different effects.

Recording Program Changes into the Sequencer

The KT sequencer can record program change events that, when played back, will automatically change the sounds assigned to sequence or song tracks at the point(s) that the program change events were recorded.

To record program change events onto a sequence or song track:

1. Select a sequence or song that has at least one track with recorded note data.
2. Press {EDIT_SEQ/PRESET}, the upper {1}, then the lower {1} button, and set the record mode to Record= ADD.
3. Press the upper {0}, then the lower {0} button. The display shows Locate page 00.
4. Select the track that you want to record program change events on by pressing its {SEQUENCER/PRESET_TRACK} button.
5. Press {PLAY}, then press {RECORD} to enter “Overdub” Standby recording. The display shows “odub” in the upper right corner. The KT is now waiting for a note or program change event to begin recording.
6. Press {REPLACE_TRACK_SOUND}. We do not recommend double-clicking the {REPLACE_TRACK_SOUND} button (Replace w/FX), as this will permanently change the sequence or song effect.
7. Use the {BANK}, {SOUNDFINDER}, {VALUE} and/or the upper {0} to {9} buttons to locate the sound that you want to change to. The sound name will be displayed, and you will hear the new sound (the sound has not been changed permanently yet).
8. At the point where you want the sound on the track to change, press the lower {0} to {9} button for the location where the sound resides. This is the second digit on the upper right side of the display (as shown below):

Press this lower {0} to {9} button

m

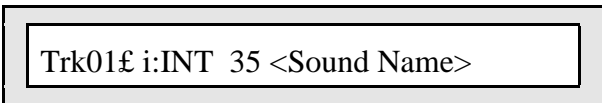

Trk01£ i:INT 35 <Sound Name>

The KT enters Overdub Record mode, and records a program change event onto the track at the point that you pressed the lower {0} to {9} button. The display will return to Locate page 00. If you do not press a lower {0} to {9} button before the sequence or song ends (or loops), a program change will *not* be recorded, and the original sound on the track will be restored. Repeat from step 7 and continue if this should happen.

9. Press {STOP"CONTINUE}, and then press {ENTER} to KEEP NEW TRACK.
10. Now when you press {PLAY}, the original sound on the track will play up to the point that you recorded the program change; it will then change to the new sound (the one selected in step 8) at the point that you pressed the lower {0} to {9} button.

About the “Save Changes?” Page

Along with the notes, controllers and program changes that are recorded on each track, there are many other parameters that are saved with each sequence or song. These are:

- The name of the sequence or song
- The tempo of the sequence or song
- The sound assigned to each track
- All Edit Track parameters for each track of the sequence or song
- Which tracks are selected and layered on the tracks
- The setting of the LOOP parameter in the Sequencer Control pages
- The setting of the CLICK parameter in the Click pages
- Punch In and Punch Out points

Whenever you record a track of a sequence or song, these values are automatically saved — that is, they will be remembered by the KT if you leave the sequence (by selecting another one) and return to it later. However, if you change any of the above settings, and then select a new sequence or song before you record any new track data, the following message may appear, depending on the setting of the SaveChangesMode parameter (Edit Seq/Presets page 15). See the description of this parameter for more information:

Save Changes? <SEQUENCE NAME>

- Pressing the {YES} button saves the sequence or song, with the current settings of all the parameters listed above, into sequencer memory.
- Pressing the {NO} button leaves the settings of the parameters listed above as they were when you last recorded a track.

In either case, the track data (notes, controllers and program changes) is always saved. Sometimes it’s hard to remember, when you get this page, exactly what you changed. As a rule, if you are happy with the sequence or song as it is, answer YES. If you have just been experimenting with different tempos, programs, MIDI configurations, etc., and want to leave the sequence as it was before your experiments, answer NO.

Tip: While in Select Sequence/Presets mode, there is one quick way to save any changes you make to a preset or song. Simply press {ENTER} twice. You can also rename the preset or song by pressing {ENTER} once, editing the name, and then pressing {ENTER} again. Do not attempt this with a sequence — it will invoke the Tap Tempo feature (see the Tap Tempo description in the following section).

You can avoid being asked to save changes by setting the SaveChangesMode parameter to U-SAVE MANUALLY (Sequencer Control, page 5). For live performance, and other applications in which you want to experiment with tempo, track parameters, etc. without being bothered about saving the changes, this is the preferred setting.

Recording MIDI Tracks

Tracks that are sent out MIDI are treated the same as tracks using KT sounds in terms of recording, overdubbing, punching in, editing, etc. Follow the same steps outlined earlier in this section for recording the first track, and then for all additional tracks. Once everything is set up, you can proceed with recording MIDI tracks exactly as you would for tracks with LOCAL or BOTH status.

For each successive track you record, the procedure will follow the same lines:

1. Define the MIDI status of the track in Edit Track mode (press {EDIT_TRACK}, followed by the lower {5} button),
2. Define the MIDI channel of the track in Edit Track mode (press {EDIT_TRACK}, then the lower {4} button),
3. Record the track, and then
4. Either keep or reject the new track from the Keep NEW/OLD page.

MIDI tracks can be selected and stacked from the {SEQUENCER/PRESET_TRACK} buttons (in Select Seq/Preset mode only), and can be muted or soloed from Edit Seq/Preset, Mute Tracks page 7, the same as any other tracks. Edit Track parameters such as Volume, Key Range and Transpose all apply to MIDI tracks just as they do to LOCAL tracks.

Note: You may record sequences and songs that contain both MIDI tracks and LOCAL tracks. When this is the case, be sure that you assign LOCAL status (as opposed to BOTH) to the tracks that you want to play only on the KT. This will avoid sending unintended MIDI data to external instruments.

Mixing, Muting and Soloing Tracks (Track Volume Functions)

Once you have recorded a few tracks of a sequence, you will want to balance the levels of the tracks, and maybe listen to them one or two at a time. This is done from Edit Track mode and from the Mute Tracks page.

1. Select a track by pressing its {SEQUENCER/PRESET_TRACK} button.
2. Press the {EDIT_TRACK} button. The KT is now in Edit Track mode.
3. Press the lower {0} button. The display shows:

```
iSEQ 00 Trk01 P Vol=127 Pan=+00
```

On this page you can balance the levels of the tracks in your sequence.

4. Press each {SEQUENCER/PRESET_TRACK} button to adjust the volume of each track. Note that this only sets the overall track volume level, and does not record real-time volume changes. If you want to record real-time mix and pan changes, see “Mixing Down Sequence and Song Tracks in Song Mode,” found later in this section.
5. Press the top {7} button to display the Track Mute Status parameter. On this page you can solo and mute individual tracks.

```
iSEQ 00 Trk01 P Status= PPP-M-PM
```

iiiiiii

Sequence Tracks 1 2 3 4 5 6 7 8
or Song Tracks 9 10 11 12 13 14 15 16

6. Press a {SEQUENCER/PRESET_TRACK} button or use the {CURSOR} buttons to select a track for editing. The **Data Entry Controls** will now Mute or Solo the current track. P means Play, M means Mute, and S means Solo. For tracks that have no recorded data, there will be a dash (-) in the display (see the discussion of Track Mute Status in *Section 11 — Sequencer Parameters* for details).

Routing Sounds to Effects in Sequence/Preset Mode

When the KT is in Sequence/Preset mode, the effect for the current sequence/preset or song is edited by pressing the {EDIT_SEQ/PRESET} button, then the upper {8} button.

The upper {8} button calls up the Effect pages. You can then use the lower {0} to {9} buttons to select the various parameters within the Effect pages.

Normally, the different voices that comprise each sound in a sequence are assigned to the three different busses (as set in the {EDIT_SOUND} Output pages). In Edit Track mode, you can override the voice output routings programmed in each sound.

The available Edit Track Output Bus settings ({EDIT_TRACK}, lower {1}) are:

- DRY forces all voices to the DRY bus
- FX1 forces all voices to FX1
- FX2 forces all voices to FX2
- VOICE uses normal voice routing as programmed in each sound
- CONTRL-FX uses normal voice routing as programmed in each sound, and routes controller information from this track to the effect. This is the default setting.

Controllers Routed to Effects

It is sometimes desirable to limit which tracks send controller information to the algorithm. This is particularly true when transmitting MIDI data on MIDI channels from an external sequencer. If more than one track is set to CONTRL-FX, “controller fights” can occur. If set to VOICE, the sound on the track will remain routed to the effects, but its controllers (such as the MOD WHEEL, PRESSURE, the TIMBRE control, etc.) will not affect the effect.

See *Section 8 — Understanding Presets* for more information.

Working in Song Mode

The KT's Song mode is the key to unlocking its true power as a master sequencer. In song mode you can chain a number of sequences together to form a song. Songs are made up of Steps — for each song step you can choose a sequence to play and the number of repetitions of that sequence, as well as mute and transpose status for each track of the sequence. The process for editing song steps is covered in *Section 11 — Sequencer Parameters*.

But wait, there's more! Each KT song also contains its own effect algorithm and set-up and eight additional tracks that are independent of the tracks in the component sequences that comprise the song steps. This gives you a 16-track sequencer with tremendous flexibility. You can choose which musical parts you want to put into the component sequences, and which parts you put in the song tracks.

Assembling a Song

On the KT, songs are made up of steps. Each step is equivalent to a sequence, and when you assemble a song, you are “chaining” sequences together. The following procedure explains how to assemble a song using sequences that you have created. Remember, there are many parameters that can be adjusted when working with songs. Only those that you will encounter when assembling sequences into songs are dealt with in this procedure.

To assemble a song

1. Press the {SELECT_SEQ/PRESET} button. The KT is now in Select Sequence/Preset mode.
2. Enter a song location from within the internal memory bank using the upper {7} through {9} buttons and the lower {0} through {9} buttons (internal memory bank, locations 70-99 are reserved for songs).
3. Press {ENTER} when you're done. A display appears with the page number of your song location flashing. This is the display on which you confirm the location of your song.
4. Press {ENTER} to confirm the location. The next display asks you to provide a name for your song.

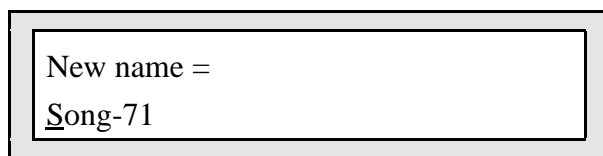

New name =
Song-71

5. Using the **Data Entry Slider** or {VALUE} buttons to select various letters, numbers, and symbols, and using the {CURSOR} buttons to choose which character to edit, spell out the name of your song. Press {ENTER} when you're finished. The display will show the location of your song, its name, and prompt you to set the tempo.

Flashing

m

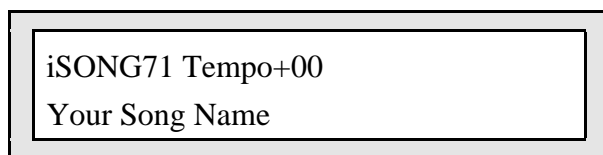

iSONG71 Tempo+00
Your Song Name

6. Set the tempo of the song (optional, this step could be done at any time). When you set the

tempo of a song, you are really setting the *tempo offset*, that is how much faster or slower than the sequence tempo the song will be. The units are percentage points. Press {ENTER} when you're finished. The next display prompts you to save the song.

7. Press {ENTER} to save the song.
8. Now press the {EDIT_SEQ/PRESET} button. This places the KT in the Edit Sequence/Preset mode.
9. Press the upper {3} button to “dial” the song command pages. Then press the lower {6} button to display the Edit Song Steps page.

iSONG71 SNGS
Edit Song Steps

10. Press {YES}. The next display prompts you to confirm the step of the song you want to change. Since we are assembling a new song in this example, and not editing an existing one, we will begin with step 1.
11. Press the {>} button so that the phrase *END OF SONG* is flashing, meaning we can select a sequence within the same bank and assign it as step 1 of our song.

Rep 1 Step 1
END OF SONG

12. Using the {[} button, scroll through the available sequences until the one you want to be step 1 is displayed.
13. Press the {<} button so that the step number is flashing. Then change the flashing “1” to a “2” by pressing the {[} button once.
14. Repeat steps 11 through 13 until you are finished assembling your song.
15. To hear your song, press the {SELECT_SEQ/PRESET} button, and then press {PLAY}.

See *Section 11 — Sequencer Parameters* for more information about the Edit Song Step parameters.

Switching Effects in Song Mode

As you are probably aware, when you are playing KT sounds, and you select a sound that uses a different effect algorithm from the previous one, there is a momentary muting of the audio output. This is because, like all digital signal processors, the KT requires some time to switch from one algorithm to another. The software program that defines the algorithm must be changed for each different effect.

The same holds true when selecting sequences. Each sequence has its own effects set-up, that is highly programmable and is saved with the sequence. When you select a sequence, if the new one has a different effect algorithm than the previous one, there will be a brief muting of the output.

This can pose a problem when playing a song — as a new song step begins to play, if the sequence in that step has a different effect than the previous one, there might be a muting of the audio output. Since it is usually not desirable to mute the output during sequencer playback, the KT offers some alternatives.

The “Song uses effect from=SEQUENCES/SONG” parameter on Sequencer Control page 3 (press {EDIT_SEQ/PRESET}, the upper {1} button, then the {3} button) determines which effect(s) will be heard when a song is played:

- When “Song uses effect from=SEQUENCES,” each time a new sequence begins as a step in a song, its effect will be loaded, resulting in a brief muting of the output (unless the new effect is the same as in the previous sequence).
- When “Song uses effect from=SONG,” the effect that is stored in the song will be used for all the song steps and there will never be any muting or “glitching” of the output when new sequences play.

The setting of this parameter is saved with each song. Whenever a new song is created, it defaults to “Song Uses Effect from=SONG.” This ensures that there will be no output muting between sequences, but it also means that a sequence might sound different in a song than when it was played on its own.

If you do use the “Song uses effect from=SEQUENCES” setting for a given song, you can minimize the muting by doing the following:

- Whenever possible, use the same effect algorithm in sequences that will be chained together in the song.
- Program a rest into the beginning of sequences in which the effect will switch to a different algorithm from the previous one, or create a silent one-bar sequence whose only function is to switch to a new algorithm. Then make sure the following sequences use the same algorithm.

Song Tracks

A Song on the KT is much more than simply a group of sequences chained together. Once you have created a song and edited its steps, you can record another complete set of eight song-length tracks. These Song Tracks are completely independent from the individual sequence tracks; each has its own sound and complete set of track parameters. Song Tracks are shown as 09-16, whereas sequence tracks are shown as 01-08. The length of the song tracks is determined by the combined length of the song's component sequences.

Let's suppose you have constructed a song. For our example, we will take three sequences, each using up to eight tracks, and combine those sequences into a song:

- Step 1 of the Song is Sequence 01 (a 4-bar sequence) for 1 Repetition;
- Step 2 is Sequence 02 (an 8-bar sequence) for 1 Repetition; and
- Step 3 is Sequence 03 (a 4-bar sequence) for 1 Repetition.

Your Song would look like this:

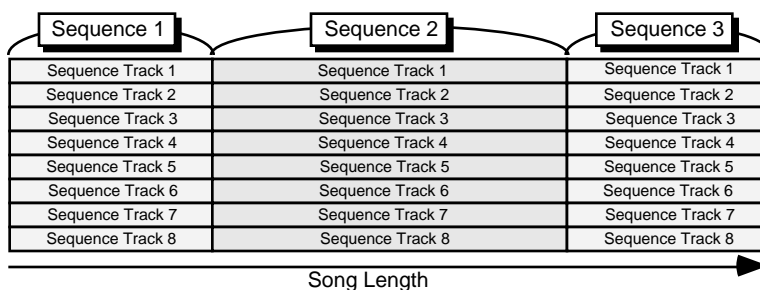

Now, with the song selected, you can press the {SEQUENCER/PRESET_TRACK} buttons and see an entirely new set of empty tracks. These are the song tracks. If you are not sure which tracks you're viewing, check the track LEDs. They flash when sequence tracks are displayed in Song mode, and remain solidly lit when song tracks are displayed. Continuing with the above example, the song tracks might look like this:

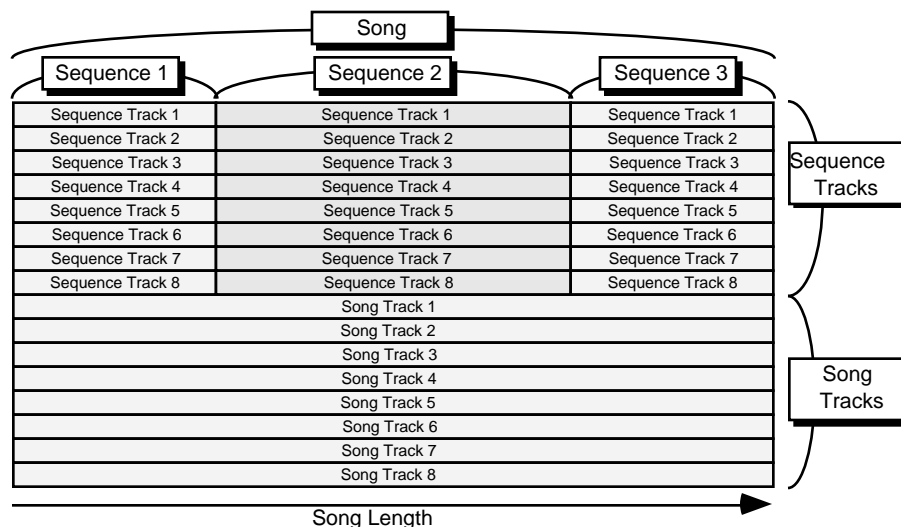

Song tracks are treated like normal sequence tracks whose length is equivalent to the combined length of all the sequences which make up the song. The length of the song tracks is set according to the song length at the time the first song track is recorded. Changes made to the song structure after the first song track is recorded will not affect the length of the song tracks.

- You can change the sound on a song track using {REPLACE_TRACK_SOUND}, just as you would a sequence track.
- You can enter record (by holding down {RECORD} and pressing {PLAY}) and record on any

of the eight song tracks. When recording song tracks, follow the same procedures (as outlined earlier in this section) that you would use when recording sequence tracks. The only difference is that a song track is associated with the song itself, and not with the individual sequences that comprise the song.

- You can edit the song tracks using any of the Edit Track parameters discussed in *Section 9 — Preset/Track Parameters*. Selecting any Edit Track parameter when a song is selected, will cause the current song track to be edited.
- You can solo, mute and adjust the volume of song tracks from the Mute Tracks page and from Edit Track mode, just as you would with sequence tracks.

Viewing Sequence Tracks in Song Mode

When a song is selected, what the display shows for the Sequencer/Preset Tracks and the Edit Track parameters depends on the setting of the “Song Edit Tracks Displayed” parameter on the Sequencer Control page.

- When “Song Edit Tracks Displayed=SONG,” the display shows the Track and Edit Track parameters for the song tracks. Any changes you make will affect the song tracks only.
- When “Song Edit Tracks Displayed=SEQ,” the Track and the Edit Track parameter pages will show the tracks of the individual sequences that make up the song steps. Any changes made to these tracks when a song is selected will not be remembered after the song step is done playing. To change anything about a sequence track, you must first select the sequence and then change it there.

When a song is selected and “Song Edit Tracks Displayed=SEQ,” the LEDs in the {SEQUENCER/PRESET_TRACK} buttons will flash to remind you that the track data is for the currently selected sequence in the song step and not the actual song tracks. Song Tracks are displayed as Tracks #09 - 16.

Tip: There is a shortcut for toggling the Song Edit Tracks Displayed parameter between SEQ and SONG: While in Edit Sequence/Preset mode, rapidly double-click any of the {SEQUENCER/PRESET_TRACK} buttons. This switches between the song tracks and the sequence tracks, just as if you had changed the setting of the “Song Edit Tracks Displayed” parameter. The LEDs in the {SEQUENCER/PRESET_TRACK} buttons flash when you are looking at sequence tracks; they remain solidly lit when the song tracks are displayed.

Mixing Down Sequence and Song Tracks in Song Mode

After you have created and edited a song, you can “mixdown” the volume and pan of the song tracks and/or sequence tracks that make up the song steps. The mixdown process does not affect the data in the individual sequences that compose the song steps; it creates a song-length Mixdown Track (which is a part of the song track) on which you can record volume and pan changes that will affect the song and/or sequence tracks over the course of the entire song. You can use this function to fine-tune the dynamics of certain tracks during part of a song, or to simply fade them out at the end of the song.

To Record Mix or Pan Changes to Sequence Tracks in a Song

1. Select a song containing sequence tracks you want to mixdown.
2. Press {EDIT_SEQ/PRESET} and select the Sequencer Control page by pressing the upper {1} button, followed by the lower {1} button.

3. Set the record parameter to “Record = MIXDOWN.”
4. Press the lower {4} button, and set the “Song Edit Tracks Displayed” parameter to “Song Edit Tracks Displayed=SEQ.”
5. Press the {SEQUENCER/PRESET_TRACK} button of the sequence track that you want to mix down. If you select Track 3, for example, the volume and pan changes you are about to record will affect whatever is on Track 3 of each sequence throughout the song.
6. Press the {EDIT_TRACK} button, and press the lower {0} button, which contains the volume level for the track, with the current track’s setting displayed (or select the Pan parameter to record dynamic panning changes).
7. While holding down {RECORD}, press {PLAY}. The KT enters Overdub.
8. Use the **Data Entry Slider** or the {VALUE} buttons to mix the volume (or pan) of the selected track. All changes you make will be recorded.
9. At the end of the song, or when you press {STOP"CONTINUE}, the Keep NEW/OLD page appears. Here you can audition the changes before deciding whether to keep the new or the original track.
10. To mix another track, press a different {SEQUENCER/PRESET_TRACK} button, select the Volume or Pan parameters and then repeat the procedure.

To Record Mix or Pan Changes to a Song Track

1. Select a song containing song tracks you want to mix down.
2. Press {EDIT_SEQ/PRESET}, and select the Sequencer Control page by pressing the upper {1} button, followed by the lower {1} button.
3. Set the record parameter to “Record = MIXDOWN.”
4. Press the lower {4} button, and set the “Song Edit Tracks Displayed” parameter to “Song Edit Tracks Displayed=SONG.”

Note: With a song selected, you can toggle between Song tracks and Sequence tracks by double-clicking any of the eight {SEQUENCER/PRESET_TRACK} buttons while in Edit Seq/Preset mode. The track’s LED will flash when the sequence tracks are being displayed, and remain solidly lit when song tracks are shown. Note also that song tracks are always shown as 09-16, where sequence tracks are shown as 01-08.

5. Press any of the {SEQUENCER/PRESET_TRACK} buttons and select the song track that you want to mix down. If you select Track 3, for example, the volume and pan changes you are about to record will affect whatever is on Song Track 3 (listed as Track 11) throughout the song.
6. Press the {EDIT_TRACK} button, and press the lower {0} button, which contains the volume level for the track, with the current track’s setting displayed (or select the Pan parameter to record dynamic panning changes).
7. While holding down {RECORD}, press {PLAY}. The KT enters Overdub.
8. Use the **Data Entry Slider** or the {VALUE} buttons to mix the volume (or pan) of the selected track. All changes you make will be recorded.
9. At the end of the song, or when you press {STOP"CONTINUE}, the Keep NEW/OLD page appears. Here you can audition the changes before deciding whether to keep the new or the original track.
10. To mix another track, press a different {SEQUENCER/PRESET_TRACK} button, select the Volume or Pan parameters and then repeat the procedure.

More About Mixdown Mode

Mixdown Volume and Mixdown Pan are recorded on the song track in a special form of ADD mode. When you record Mixdown Volume or Pan, the information is added to the data in the song tracks. This means that:

- The Mixdown data is always recorded into the current song track, whether you are mixing a sequence track or a song track.
- If you have recorded Mixdown volume or pan into a track and want to erase and re-record it, you must first remove the original volume or pan using the Filter Events command in the Track Commands pages (see *Section 11* for details). Otherwise, new Mixdown information would be added to (and conflict with) the existing Mixdown information.
- If you erase the song track, the Mixdown volume and pan data will be lost. Recording notes, controllers, etc. on the song track does not affect the Mixdown information, but erasing the track (using the Erase Track command on the Track Commands page) will remove the Mixdown data.

Whenever possible, you should use this function as the last step in the production chain, after you have finished changing the song length, recording and erasing song tracks, etc.

Tip: There is another way to record dynamic volume changes into a sequence or song track. You can use the optional CVP-1 Foot Pedal to record volume changes into a sequence track while the sequence is selected, or into a song track. Just set “CV-Pedal=VOL #7” on {SYSTEM“MIDI} page 3, and then record the Foot Pedal changes in ADD mode. This will record Volume (MIDI controller #7) messages onto the track that are separate from the mixdown volume described above.

Delay Times/Tempo BPM Chart

This chart shows the relationship between delay times and tempo beats per minute. Values shown are accurate to 2 decimal places—since most delay devices are not accurate to 2 decimal places, you may have to round off these values. You can use this chart to set the effect delay times to sync to your sequence or song.

BPM	1/4 NOTE	1/8th NOTE	1/8 TRIPLET	1/16th NOTE
40	1500.00	750.00	500.00	375.00
41	1463.41	731.71	487.80	365.85
42	1428.57	714.29	476.19	357.14
43	1395.35	697.67	465.12	348.84
44	1363.64	681.82	454.55	340.91
45	1333.33	666.67	444.44	333.33
46	1304.35	652.17	434.78	326.09
47	1276.60	638.30	425.53	319.15
48	1250.00	625.00	416.67	312.50
49	1224.49	612.24	408.16	306.12
50	1200.00	600.00	400.00	300.00
51	1176.47	588.24	392.16	294.12
52	1153.85	576.92	384.62	288.46
53	1132.08	566.04	377.36	283.02
54	1111.11	555.56	370.37	277.78
55	1090.91	545.45	363.64	272.73
56	1071.43	535.71	357.14	267.86
57	1052.63	526.32	350.88	263.16
58	1034.48	517.24	344.83	258.62
59	1016.95	508.47	338.98	254.24
60	1000.00	500.00	333.33	250.00
61	983.61	491.80	327.87	245.90
62	967.74	483.87	322.58	241.94
63	952.38	476.19	317.46	238.10
64	937.50	468.75	312.50	234.38
65	923.08	461.54	307.69	230.77
66	909.09	454.55	303.03	227.27
67	895.52	447.76	298.51	223.88
68	882.35	441.18	294.12	220.59
69	869.57	434.78	289.86	217.39
70	857.14	428.57	285.71	214.29

BPM	1/4 NOTE	1/8th NOTE	1/8 TRIPLET	1/16th NOTE
71	845.07	422.54	281.69	211.27
72	833.33	416.67	277.78	208.33
73	821.92	410.96	273.97	205.48
74	810.81	405.41	270.27	202.70
75	800.00	400.00	266.67	200.00
76	789.47	394.74	263.16	197.37
77	779.22	389.61	259.74	194.81
78	769.23	384.62	256.41	192.31
79	759.49	379.75	253.16	189.87
80	750.00	375.00	250.00	187.50
81	740.74	370.37	246.91	185.19
82	731.71	365.85	243.90	182.93
83	722.89	361.45	240.96	180.72
84	714.29	357.14	238.10	178.57
85	705.88	352.94	235.29	176.47
86	697.67	348.84	232.56	174.42
87	689.66	344.83	229.89	172.41
88	681.82	340.91	227.27	170.45
89	674.16	337.08	224.72	168.54
90	666.67	333.33	222.22	166.67
91	659.34	329.67	219.78	164.84
92	652.17	326.09	217.39	163.04
93	645.16	322.58	215.05	161.29
94	638.30	319.15	212.77	159.57
95	631.58	315.79	210.53	157.89
96	625.00	312.50	208.33	156.25
97	618.56	309.28	206.19	154.64
98	612.24	306.12	204.08	153.06
99	606.06	303.03	202.02	151.52
100	600.00	300.00	200.00	150.00
101	594.06	297.03	198.02	148.51

BPM	1/4 NOTE	1/8th NOTE	1/8 TRIPLET	1/16th NOTE
102	588.24	294.12	196.08	147.06
103	582.52	291.26	194.17	145.63
104	576.92	288.46	192.31	144.23
105	571.43	285.71	190.48	142.86
106	566.04	283.02	188.68	141.51
107	560.75	280.37	186.92	140.19
108	555.56	277.78	185.19	138.89
109	550.46	275.23	183.49	137.61
110	545.45	272.73	181.82	136.36
111	540.54	270.27	180.18	135.14
112	535.71	267.86	178.57	133.93
113	530.97	265.49	176.99	132.74
114	526.32	263.16	175.44	131.58
115	521.74	260.87	173.91	130.43
116	517.24	258.62	172.41	129.31
117	512.82	256.41	170.94	128.21
118	508.47	254.24	169.49	127.12
119	504.20	252.10	168.07	126.05
120	500.00	250.00	166.67	125.00
121	495.87	247.93	165.29	123.97
122	491.80	245.90	163.93	122.95
123	487.80	243.90	162.60	121.95
124	483.87	241.94	161.29	120.97
125	480.00	240.00	160.00	120.00
126	476.19	238.10	158.73	119.05
127	472.44	236.22	157.48	118.11
128	468.75	234.38	156.25	117.19
129	465.12	232.56	155.04	116.28
130	461.54	230.77	153.85	115.38
131	458.02	229.01	152.67	114.50
132	454.55	227.27	151.52	113.64
133	451.13	225.56	150.38	112.78
134	447.76	223.88	149.25	111.94
135	444.44	222.22	148.15	111.11
136	441.18	220.59	147.06	110.29
137	437.96	218.98	145.99	109.49
138	434.78	217.39	144.93	108.70
139	431.65	215.83	143.88	107.91
140	428.57	214.29	142.86	107.14
141	425.53	212.77	141.84	106.38
142	422.54	211.27	140.85	105.63
143	419.58	209.79	139.86	104.90
144	416.67	208.33	138.89	104.17
145	413.79	206.90	137.93	103.45
146	410.96	205.48	136.99	102.74
147	408.16	204.08	136.05	102.04
148	405.41	202.70	135.14	101.35
149	402.68	201.34	134.23	100.67
150	400.00	200.00	133.33	100.00
151	397.35	198.68	132.45	99.34
152	394.74	197.37	131.58	98.68
153	392.16	196.08	130.72	98.04
154	389.61	194.81	129.87	97.40
155	387.10	193.55	129.03	96.77
156	384.62	192.31	128.21	96.15
157	382.17	191.08	127.39	95.54
158	379.75	189.87	126.58	94.94
159	377.36	188.68	125.79	94.34
160	375.00	187.50	125.00	93.75
161	372.67	186.34	124.22	93.17
162	370.37	185.19	123.46	92.59
163	368.10	184.05	122.70	92.02
164	365.85	182.93	121.95	91.46
165	363.64	181.82	121.21	90.91
166	361.45	180.72	120.48	90.36
167	359.28	179.64	119.76	89.82
168	357.14	178.57	119.05	89.29
169	355.03	177.51	118.34	88.76
170	352.94	176.47	117.65	88.24
171	350.88	175.44	116.96	87.72
172	348.84	174.42	116.28	87.21
173	346.82	173.41	115.61	86.71
174	344.83	172.41	114.94	86.21
175	342.86	171.43	114.29	85.71
176	340.91	170.45	113.64	85.23
BPM	1/4 NOTE	1/8th NOTE	1/8 TRIPLET	1/16th NOTE
177	338.98	169.49	112.99	84.75
178	337.08	168.54	112.36	84.27
179	335.20	167.60	111.73	83.80
180	333.33	166.67	111.11	83.33
181	331.49	165.75	110.50	82.87

182	329.67	164.84	109.89	82.42
183	327.87	163.93	109.29	81.97
184	326.09	163.04	108.70	81.52
185	324.32	162.16	108.11	81.08
186	322.58	161.29	107.53	80.65
187	320.86	160.43	106.95	80.21
188	319.15	159.57	106.38	79.79
189	317.46	158.73	105.82	79.37
190	315.79	157.89	105.26	78.95
191	314.14	157.07	104.71	78.53
192	312.50	156.25	104.17	78.13
193	310.88	155.44	103.63	77.72
194	309.28	154.64	103.09	77.32
195	307.69	153.85	102.56	76.92
196	306.12	153.06	102.04	76.53
197	304.57	152.28	101.52	76.14
198	303.03	151.52	101.01	75.76
199	301.51	150.75	100.50	75.38
200	300.00	150.00	100.00	75.00
201	298.51	149.25	99.50	74.63
202	297.03	148.51	99.01	74.26
203	295.57	147.78	98.52	73.89
204	294.12	147.06	98.04	73.53
205	292.68	146.34	97.56	73.17
206	291.26	145.63	97.09	72.82
207	289.86	144.93	96.62	72.46
208	288.46	144.23	96.15	72.12
209	287.08	143.54	95.69	71.77
210	285.71	142.86	95.24	71.43
211	284.36	142.18	94.79	71.09
212	283.02	141.51	94.34	70.75
213	281.69	140.85	93.90	70.42
214	280.37	140.19	93.46	70.09
215	279.07	139.53	93.02	69.77
216	277.78	138.89	92.59	69.44
217	276.50	138.25	92.17	69.12
218	275.23	137.61	91.74	68.81
219	273.97	136.99	91.32	68.49
220	272.73	136.36	90.91	68.18
221	271.49	135.75	90.50	67.87
222	270.27	135.14	90.09	67.57
223	269.06	134.53	89.69	67.26
224	267.86	133.93	89.29	66.96
225	266.67	133.33	88.89	66.67
226	265.49	132.74	88.50	66.37
227	264.32	132.16	88.11	66.08
228	263.16	131.58	87.72	65.79
229	262.01	131.00	87.34	65.50
230	260.87	130.43	86.96	65.22
231	259.74	129.87	86.58	64.94
232	258.62	129.31	86.21	64.66
233	257.51	128.76	85.84	64.38
234	256.41	128.21	85.47	64.10
235	255.32	127.66	85.11	63.83
236	254.24	127.12	84.75	63.56
237	253.16	126.58	84.39	63.29
238	252.10	126.05	84.03	63.03
239	251.05	125.52	83.68	62.76
240	250.00	125.00	83.33	62.50
241	248.96	124.48	82.99	62.24
242	247.93	123.97	82.64	61.98
243	246.91	123.46	82.30	61.73
244	245.90	122.95	81.97	61.48
245	244.90	122.45	81.63	61.22
246	243.90	121.95	81.30	60.98
247	242.91	121.46	80.97	60.73
248	241.94	120.97	80.65	60.48
249	240.96	120.48	80.32	60.24
250	240.00	120.00	80.00	60.00

Tip: Assign a controller to modulate the effect delay times, and select a specified minimum and maximum range so that you can create unique poly-rhythms in real time. See *Section 3 — Understanding Effects* for information on assigning effect modulators.

Section 12 — The MIDI Connection

This section gives you step by step procedures for using MIDI with the KT, covers some advanced sequencer applications, and describes using the KT with external MIDI devices. This section also offers an introduction and overview of General MIDI, and explains how to use it with the KT.

About MIDI

MIDI stands for Musical Instrument Digital Interface — that magical connection that lets you play one instrument (or a whole roomful of them) from another. MIDI is a standard that has been agreed upon by manufacturers for translating musical events into specific numbers which are transmitted and received by MIDI instruments.

For instance, when you play middle C on the KT, it instantly sends to its **MIDI Out** jack a series of numbers representing a *Key Down* event, along with the location of the note on the keyboard and how hard the key was struck. When you release the key, the KT sends a number meaning *Key Up*. A MIDI instrument connected to the KT can receive and translate those numbers, and will play the middle C. The same thing happens whenever you move a controller, such as the **Pitch** or **Mod Wheel**, or when you select a new sound — each of these events is translated into a series of numbers which are transmitted out the **MIDI Out** jack.

Controlling Remote MIDI Devices from the KT — MIDI Connections

You can use the KT sequencer to drive external MIDI devices, greatly enhancing the number of available voices and timbres. On Edit Track page {5}, a sequence/preset or song track's MIDI status can be set to:

MIDI — so that it plays only out MIDI
 LOCAL — so that it will play only locally on the KT
 BOTH — so that it will play a local sound and send on its designated MIDI channel.

When controlling multiple remote MIDI devices, first connect the various devices to the KT, and to each other, as shown here. Connect a MIDI cable from the **MIDI Out** jack of the KT to the **MIDI In** jack of device #1. Then connect the **MIDI Thru** jack of device #1 to the **MIDI In** jack of device #2. Connect the **MIDI Thru** jack of device #2 to the **MIDI In** jack of device #3. And so on for as many devices as you will be using.

With this arrangement, once you set up the proper MIDI channels, etc., each remote MIDI device will receive and play only the data that is intended for it, and will “pass along” all other data. Also, each can be played from its own keyboard (as well as from the KT's) without affecting the others, because **MIDI Thru** jacks only pass along incoming MIDI data, and do not transmit what is played on the instrument.

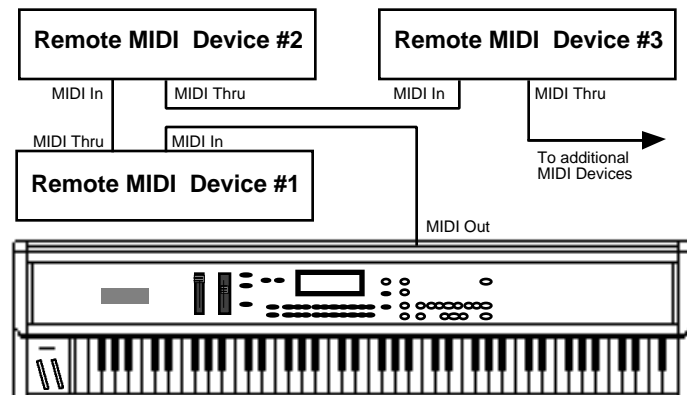

This set up is ideal for controlling everything right from the KT. Simply by selecting the track that is set to the same MIDI channel as a particular instrument, you can:

- Play the remote MIDI device from the KT keyboard
- Record a track that will play back on the MIDI device when you play the sequence or song
- Send the remote MIDI device program changes and adjust its volume (assuming the device receives MIDI Volume)

In other words, once you have made the appropriate connections and set up the MIDI configuration of the tracks and all remote MIDI devices, you can use the KT's keyboard and its front panel to control and record all the remote MIDI devices in your rig.

Setting up Remote MIDI Devices to Receive MIDI from the KT

The next step is to set up each remote MIDI device to receive only the MIDI information that is intended for it. When each receiving unit is set to receive on a different MIDI channel (or a number of them, for multi-timbral units), you can control them all right from the KT. For each destination instrument:

- **Set to POLY (or OMNI OFF) or MULTI Mode.** Each remote MIDI device must be in a mode where it receives only on its selected MIDI channel (or channels). This is usually referred to as POLY (or OMNI OFF) mode for receiving on a single channel, or MULTI mode for receiving independently on multiple channels. Consult the owner's manual if there is any question about a particular instrument.
- **Select a MIDI channel or channels.** The best idea is to assign each destination instrument its own MIDI channel(s) and leave it that way. For instance, if you know that a certain synth is always set to receive on MIDI channel 4, you can quickly set up a track to drive that synth by simply selecting an undefined track, then assigning that track MIDI Status and MIDI channel 4 in Edit Track mode. Also when each destination instrument is always set to its own distinct MIDI channel, it means that different sequences and songs recorded at different times will always play the right instrument on the right track.

Once you have assigned MIDI channels to each instrument in your rig, *write them down*, and keep the paper handy for quick reference.

Creating a Sequence/Preset For Controlling Remote MIDI Sound Sources

After you have made the MIDI connections and set up your destination instruments as described above, you can now configure the tracks of a preset to send to those remote MIDI devices. You can create a "template" (saved as a preset) that sends multi-timbral information to do this. This allows you to send MIDI information to other sound sources so that you can use the voices of other MIDI devices within a KT sequence, or in a live performance situation. A KT sequence/preset can use voices from external MIDI instruments, greatly enhancing the number of available voices and timbres.

For each track that you want to drive a remote MIDI device, set the track's MIDI Status and select a MIDI channel and program number that matches the receiving devices. These parameters are covered in detail in *Section 9 — Preset/Track Parameters*.

Once you have made the appropriate connections and set up the MIDI configuration of the tracks and all remote devices, you can use the KT's sequences/presets to create a template using all the instruments in your rig.

Note: The KT allows MIDI transmission of release velocity (how fast the key is let up). Some modern keyboards and synth modules respond to this feature allowing you to better articulate your sound. However, the KT voices do not respond to release velocity.

Setting Track Parameters for MIDI Controller Application

After you have made the MIDI connections and set up your remote instruments as described above, you can now configure the tracks of a sequence/preset to send MIDI information to those instruments. Let's suppose that you want to use several external instruments for sequencing.

For each track that you want to drive a remote MIDI sound:

1. Press {SELECT_SEQ/PRESET}.
2. Press the {SEQUENCER/PRESET_TRACK} button.
3. Press the {EDIT_TRACK} button.
4. Press the lower {4} button, and hold it down for a moment.
5. Using the {VALUE} buttons, select the Chan parameter to match the MIDI channel of the sound in your remote MIDI device.
6. Press the {>} button.
7. Using the {VALUE} buttons, select a MIDI Program Number that matches the program number of the sound you wish to use in your remote MIDI device.
8. Press the lower {5} button.
9. Using the {VALUE} buttons, set the track's MIDI Status to "Status = MIDI."

Repeat the above steps for each track that you want to drive a remote MIDI sound. Once you've created a template, you can save it internally in the KT:

1. Press the {SAVE} button. Depending on whether or not you've created a sequence using your template, the display will read either "Save SEQ <seq name>?" or "Save PRESET <seq name>?" (The name listed is the name of the sequence/preset you began with when editing).
2. Select a name of up to 16 characters for your template using the **Data Entry Controls**. The {CURSOR} buttons select the character to be edited, while the **Data Entry Slider** and {VALUE} buttons scroll through the letters, numbers, and icons that can be used to name the sound.
3. After you've written your template's name, press the {ENTER} button.
4. The display will show a momentary "SAVED" message before returning to the current parameter.

Now that your template has been created and saved, you can select it at any time by pressing the {SELECT_SEQ/PRESET} button followed by the appropriate {0} to {9} buttons to select its memory location.

Note: The Make Default Preset function can also be used to configure the tracks of a sequencer/preset to send MIDI information, and is explained in *Section 8 — Understanding Presets*.

Using External MIDI Sequencers

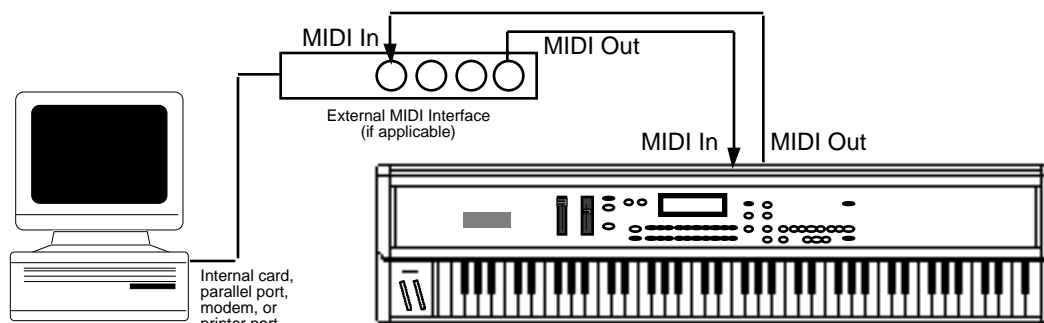

Computer (with MIDI Interface) connected to KT Keyboard

Connecting the KT to a computer (or other MIDI sequencer)

The following steps describe how to connect your KT to a computer or other MIDI sequencer. Refer to the above illustration when making these connections.

1. Power down all electronic devices before making any connections.
2. Using a MIDI Cable, connect the **MIDI In** jack of the KT to the MIDI Out jack of the computer/hardware sequencer/sequence player. This allows MIDI data that is transmitted from the external sequencer to be received and played back by the KT.
3. With a second MIDI cable, connect the MIDI Out jack of the KT to the MIDI In jack of the external sequencer or computer. This allows notes and controllers that are played on the KT to be transmitted to the external sequencer for recording.

Note: Many computers do not have MIDI jacks built into them, and require an additional MIDI Interface connector between the computer and the KT.

4. Make sure the proper amplification is connected to the KT, and power on the computer, the KT keyboard, and the amplification system (in that order).

Selecting MULTI Mode — Receiving on up to 8 MIDI Channels

MULTI mode is the key to unlocking the potential of the KT as a multi-timbral MIDI receiver for use with external MIDI sequencers/controllers. In MULTI mode, the 8 tracks of the current sequence or song can receive MIDI information independently and polyphonically on up to 8 different MIDI channels. Here's how to select MULTI mode:

1. Press {SYSTEM" MIDI}, followed by the lower {6} button. The display looks like this:

Flashing

m

MIDI Mode=OMNI Xctrl = 002

2. Using the **Data Entry Controls**, select the MIDI Mode parameter and set it to MULTI.

Creating a Preset for use with MIDI Sequencing

After selecting MULTI mode, as described above, the next step in the process is to create a preset that will configure the KT for MIDI transmission and reception.

1. Press the {SELECT_SEQ/PRESET} button. The KT will display the last preset, sequence, or song that was selected.
2. Using the upper {0} through {6} buttons and the lower {0} through {9} buttons, select a new location for your preset. Press {ENTER} when you're done. The next display asks you to confirm your choice. Press {ENTER} one more time.
3. A display appears asking you to set the time signature. Since the KT doesn't know whether you're creating a sequence or a preset (which are similar processes), press {ENTER} twice to confirm both parts of the time signature. The next display asks you to name your preset.
4. Using the {<} and {>} buttons, the **Data Entry Slider**, and the {CURSOR} buttons to spell out the name of your preset. Use a name that describes the special use of this preset, "MIDI PRESET", for example. Press {ENTER} when you're finished. The display will show the name of your preset and its location.
5. Press the {EDIT_TRACK} button, then the first {SEQUENCER/PRESET_TRACK} button.
6. Press the lower {5} button to select the MIDI Status page.

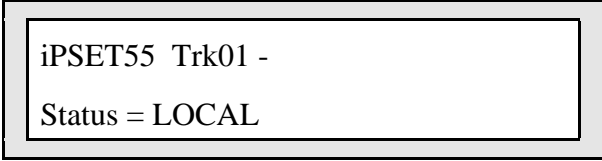

iPSET55 Trk01 -
Status = LOCAL

7. Use the {VALUE} buttons to change the Status parameter to "BOTH".

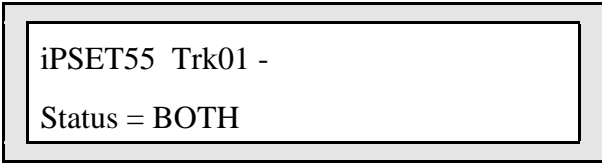

iPSET55 Trk01 -
Status = BOTH

8. Select each of the remaining seven tracks of the preset by pressing their {SEQUENCER/PRESET_TRACK} button and change the Status parameter from "LOCAL" to "BOTH".
9. After you've set the MIDI status to "BOTH" for all eight tracks, save your preset by pressing the {SAVE} button twice (once to confirm the name of the preset, which you could change at this time, and once to save the preset).

Assigning MIDI Reception Channels

The final step in using the KT with an external multi-track MIDI sequencer is to assign each track in the current KT sequence or song to receive on the desired MIDI channel.

Each of the 8 tracks of the current sequence or song are controlled independently in MULTI mode. The KT defaults to the MIDI channel assignments shown in the diagram below. You can change these assignments as necessary, and set any of the 8 tracks to receive on any of the 16 available MIDI channels. You can also set a track's MIDI Status to *EXT* so that it does not receive incoming MIDI at all (press the lower {5} button to select the MIDI Status page).

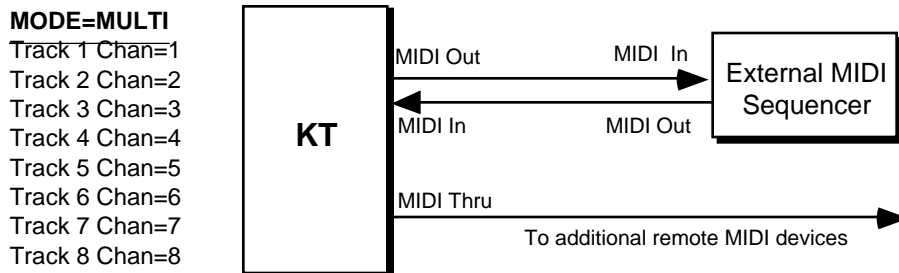

If you do not want to use these default settings, you can change the MIDI channel assignments. Here's how:

1. Press {EDIT_TRACK}, followed by the lower {4} button. The following Edit Track page appears:

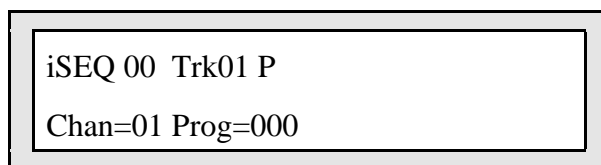

2. After selecting a track by pressing its {SEQUENCER/PRESET_TRACK} button, you can use the {VALUE} buttons to change each track's channel assignment, if desired.

Note: Only one track can receive on a given MIDI Channel. If two (or more) tracks are set to the same MIDI Channel, the lower-numbered track will receive on that channel and any higher-numbered track(s) set to the same channel will not receive at all.

Using the KT with a Drum Machine

There are basically three ways to use the KT with a drum machine or another rhythm sequencer:

- Sync the drum machine's clock to the KT
- Sync the KT's clock to the drum machine
- Sequence the drum machine's internal sounds from the KT (just as you would an external synthesizer)

To Sync a Drum Machine to the KT:

1. Connect the **MIDI Out** of the KT to the **MIDI In** of the drum machine.
2. Set the drum machine to sync to MIDI clocks.
3. Set the drum machine to receive on an unused MIDI channel, OMNI Off; or disable channel information. You don't want the drum machine playing KT sequence data intended for other instruments. MIDI Clocks, Start, Stop, and Continue are System real-time commands, and are sent and received regardless of MIDI channel or mode.
4. The drum machine should now sync to the KT's clock. Pressing {PLAY} or {STOP"CONTINUE} will start, stop, and continue the drum machine, assuming it receives those commands.

To Sync the KT to a Drum Machine:

1. Connect the **MIDI Out** of the drum machine to the **MIDI In** of the KT.
2. Press {EDIT_SEQ/PRESET}, the upper {1} button, then the lower {2} button.
3. Using the **Data Entry Controls**, select the Clock parameter and set it to "Clock=MIDI."

This sets the KT to sync to MIDI clocks.

4. Set the drum machine to not send channel information, or to send it on a MIDI channel that is not being used by any of the KT tracks. Again, MIDI Clocks, Start, Stop, and Continue are sent and received regardless of MIDI channel or mode.
5. The KT should now sync to the drum machine's clock. Starting, stopping, or continuing the drum machine will start, stop, and continue the KT.

To Sequence a Drum Machine from a Track of the KT:

1. Connect the **MIDI Out** of the KT to the **MIDI In** of the drum machine.
2. Set the drum machine to **Tape Sync** or **Internal Clock**, or any setting other than **External** or **MIDI Clock**. This way it will not play its own patterns, but will act only as a sound-producing device, sequenced from a track of the KT.
3. Set the drum machine to **POLY (OMNI Off)** mode, and select a MIDI channel.
4. From **Edit Track** mode, assign a track on the KT to **Status = MIDI**, and set it to the same MIDI channel you assigned the drum machine.
5. You should now be able to play the drum machine from the KT keyboard. You can then record a track on the KT, from the KT keyboard, which will play on the drum machine — just as if you were sequencing an external synthesizer.

The advantage of this approach is that some drum machines respond better to velocity when played from MIDI than when played from their own front panels. Thus, you may get more dynamic range out of your drum machine if you use this approach. The disadvantage is that you use up KT sequencer memory to sequence the drum machine.

Song Position Pointers

The KT sends and receives **Song Position Pointers** via MIDI. **Song Position Pointers** are MIDI commands that tell a sequencer or drum machine where to locate within a song or sequence. When the KT receives a **Song Position Pointer**, it will locate to the appropriate place in the selected song or sequence.

The KT sends a **Song Position Pointer** over MIDI whenever you use the **Auto Locate** control (the **Goto** function on the **Locate** page). Any receiving unit that recognizes **Song Position Pointers** will locate to the same spot. Not all devices recognize **Song Position Pointers**. To determine if any other sequencing device you are using does, consult its manual.

MIDI Song Selects

MIDI Song Selects allow a sequencer such as the KT to instruct a remote MIDI sequencer or drum machine to select a new song whenever you select a **Sequence** or **Song** on the KT. Whether or not the KT transmits and receives them depends on the setting of the **Song Select** parameter on **System • MIDI** page 8.

The KT transmits and receives **MIDI Song Selects** in **Sequence** mode as well as **Song** mode (depending again on the setting on the “**Song Select**” parameter). This allows you to select any KT sequencer location from a remote sequencer, computer or drum machine, and vice versa. They are set up as follows:

MIDI Song Selects 00-99 will select **KT Sequence/Song** locations **00-99**. Selecting **Sequence/Song** locations **00-99** will cause the KT to transmit **MIDI Song selects 00-99**.

Using the KT with a MIDI Guitar Controller

The KT makes an ideal voice module to use with any MIDI guitar controller that can send in MONO mode. MONO mode (MIDI mode 4) allows a guitar controller to send the notes played by each string on a different MIDI channel. This has the advantage of letting each string send pitch bends independently, allowing the guitarist to bend some notes, while holding others.

Some earlier guitar synths do not support MONO mode. You will have to consult the manual of your particular model to see if it does. If you have a guitar synth that only sends in POLY mode (i.e., sends all six strings on the same MIDI channel) you should use the KT in POLY mode (or OMNI mode) and set the guitar controller to send on the MIDI channel that is selected as the Base Channel on System•MIDI page 4.

For MIDI guitar controllers that do support MONO mode, the KT provides two types of MONO mode reception. The first is MONO A mode, which is a simple and straightforward way of using MONO mode without getting involved with tracks or other complications:

1. Connect the MIDI Out of the guitar controller (or its MIDI converter) to the **MIDI In** of the KT.
2. Set your guitar controller to send in MONO mode on channels 1-6 (some models have an easy shortcut for getting into this state).
3. On System•MIDI page 4, set the Base MIDI Channel to “Base Channel= 01.”
4. On System•MIDI page 6, set the MIDI mode parameter to “MIDI Mode=MONO A.” This sets up the KT to respond monophonically to eight consecutive MIDI channels, starting from the Base Channel. However, you will probably need only six MIDI channels, since most guitar controllers only have six strings (see *Section 2 — System•MIDI Parameters* for a more complete description of MONO mode).

You can now select sounds or presets on the KT, either from the front panel or from MIDI program changes, and the guitar controller will play those sounds exactly as if they were played from the keyboard.

If you are a little more adventurous, and would like the flexibility to put a different sound program on every string of the guitar, you can use MONO B mode, in which each track of the current sequence receives monophonically on its own MIDI channel, and can receive program changes independently. Where MONO A is like POLY mode with monophonic reception, MONO B is just like MULTI mode, except that each track is monophonic.

1. On System•MIDI page 6, set the MIDI mode to “MIDI Mode= MONO B.” Each of the eight tracks of the current Preset will now receive monophonically on its own MIDI channel.
2. Create a new Preset. You might want to name it “MONO-B IN,” or something similar, to indicate that it is specially set up for this type of reception.
3. Select each of the first six tracks, defining them and putting the current sound on them. You can leave tracks 7 and 8 undefined.
4. Press {EDIT_TRACK}, followed by the lower {4} button. Here you select the MIDI channels for the different tracks. Select each track (by pressing its {SEQUENCER/PRESET_TRACK} button) and edit it accordingly. Unlike MONO A, in this mode the consecutive MIDI channel assignments are not automatic. You must manually set the tracks to six consecutive MIDI channels.

Now you're ready to play. A few things to keep in mind:

- Notes played on each string will play only the corresponding track. Each string/track combination is totally independent.
- You can change the program for each track manually from the KT's front panel (using the Replace Track Sound function) or by sending program changes from the controller via MIDI.
- Each track will accept program changes independently. Sometimes you will want to have the guitar controller send the same-numbered program change on all six channels so that all six strings play the same sound. You can, however, send the KT a different program change for each track. You could use this effect to have, for example, a bass sound play on the bottom two strings and a piano sound on the top four. Or, if you are feeling experimental, you could play a different sound on each string.
- It's a good idea to set up and save a special preset that you always use with the guitar controller. This way you won't accidentally change the sounds on the tracks of an existing sequence.
- If your guitar controller can send certain MIDI controllers on their own MIDI channels, have it send any controllers you want to affect all the tracks (such as the "whammy bar") on the Base-Channel-minus-1. When the Base Channel=1, Global controllers should be sent on Channel 16.

What is General MIDI?

The KT completely conforms to the full General MIDI Specification. This allows you to play back any General MIDI-based sequence via incoming MIDI and always get predictable results.



General MIDI (GM) is an industry standard for program mapping that defines 128 sounds and their locations. This means that if a device conforms to the GM standard, MIDI Program Change #1 will always call up an acoustic piano. MIDI Program Change #62 will always call up a brass section, etc. Although the actual sounds (tone and quality) will vary from product to product, each specific MIDI Program number will always call up the same *type* of sound.

Sound Map

The General MIDI Sound Map (found later in this section) lists the 128 General MIDI sounds in the KT ROM and their assigned General MIDI Program Change numbers.

Percussion

General MIDI also includes a Percussion Key Map, defining specific drum voices for each key. To avoid confusion, General MIDI *always* assigns percussion to MIDI channel 10. The General MIDI Percussion Key Map can be found after the General MIDI Sound Map.

GS/MT-32 Compatibility

GS is an extended MIDI sound specification originated by Roland® Corp. Although we provide the GS Drum Maps (listed later) and MT-32 Program Change Map for Roland Sound Canvas™ compatibility, the KT is not GS compatible and does not contain the GS Alternate Sound Banks.

Other General MIDI Requirements

A General MIDI sound module must respond to all 16 MIDI channels, with dynamic voice allocation, and a minimum of 24 voices. It also must respond to velocity, pitch bend, mod wheel,

volume and pan, expression, sustain, and the All Notes Off and Reset All Controllers messages. With these controllers supported, a composition that relies on note articulations and mix settings can be played back and still sound correct when played by any GM sound module. The KT supports all of the above MIDI messages, and fully conforms to the General MIDI Specification.

Why use General MIDI?

While the KT instruments are a superb sound source, with greater fidelity and more programmability than most GM modules, there are interesting applications for General MIDI that can enhance your music making.

1. There is an interesting genre of music software (for your computer) that creates backing patterns for you to play along with, for pleasure and study. These programs include:

Band in a Box

For more information contact:
 PG Music Inc.
 266 Elmwood Avenue
 Suite 111
 Buffalo, NY 14222
 Voice 1-800-268-6272 or 905-528-2368
 FAX 905-628-2541

Jammer

For more information contact:
 Soundtrek
 3384 Hill Dr.
 Duluth, GA 30136
 Voice 404-623-0879
 FAX 404-623-3054

MiBac Jazz

For more information contact:
 MiBac Music Software
 PO Box 468
 Northfield, MN 55057
 Voice 507-645-5851

2. Many pre-recorded pieces of music can be purchased for home listening, solo performance backing tracks (e.g., instant karaoke), and other applications. Note that this application requires a computer/hardware sequencer/sequencer player and some type of computer software (such as those listed above). Look through current issues of music/computer software magazines for listings (these products must conform to the Standard MIDI File [SMF] format* in order to use them properly).

* A Standard MIDI File (SMF) is a MIDI protocol designed for sharing sequences between different products.
3. There is an ever-increasing amount of educational software that uses General MIDI for such applications as ear training, music lessons, etc.
4. Some computer games offer General MIDI as an optional sound source. The KT will provide high quality sound variations for this enjoyable leisure activity, enhancing the excitement and thrill of your computer games.

General MIDI Sound Map

The following map shows the General MIDI sound name and program change number of each sound as they appear in the KT. This map also shows how General MIDI divides the instruments into 16 categories of similar sounds:

PROG #	INSTRUMENT	PROG #	INSTRUMENT	PROG #	INSTRUMENT	PROG #	INSTRUMENT
1-8	PIANO	33-40	BASS	65-72	REED	97-104	SYNTH EFFECTS
1	Grand Piano	33	Acoustic Bass	65	Soprano Sax	97	Ice Rain
2	Bright Piano	34	Fingered Bass	66	Alto Sax	98	Soundtrack
3	ElectricGrand	35	Picked Bass	67	Tenor Sax	99	Crystal
4	HonkyTonk Pno	36	Fretless Bass	68	Baritone Sax	100	Atmosphere
5	Elec. Piano 1	37	Slap Bass 1	69	Oboe	101	Brightness
6	Elec. Piano 2	38	Slap Bass 2	70	English Horn	102	Goblin
7	Harpichord	39	Synth Bass 1	71	Bassoon	103	Echo Drops
8	Clavinet	40	Synth Bass 2	72	Clarinet	104	Star Theme
9-16	CHROM PERCUSSION	41-48	STRINGS	73-80	PIPE	105-112	ETHNIC
9	Celesta	41	Violin	73	Piccolo	105	Sitar
10	Glockenspiel	42	Viola	74	Flute	106	Banjo
11	Music Box	43	Cello	75	Recorder	107	Shamisen
12	Vibraphone	44	Contra Bass	76	Pan Flute	108	Koto
13	Marimba	45	TremoloStrngs	77	Bottle Blow	109	Kalimba
14	Xylophone	46	Pizzicato	78	Shakuhachi	110	Bagpipes
15	Tubular Bell	47	Harp	79	Whistle	111	Fiddle
16	Dulcimer	48	Tympani	80	Ocarina	112	Shanai
17-24	ORGAN	49-56	ENSEMBLE	81-88	SYNTH LEAD	113-120	PERCUSSIVE
17	Drawbar Organ	49	Strings	81	Square Wave	113	Tinkle Bell
18	Perc. Organ	50	Slow Strings	82	Saw Wave	114	Agogo
19	Rock Organ	51	SynthString 1	83	SynthCalliope	115	Steel Drum
20	Church Organ	52	SynthString 2	84	Chiffer Lead	116	Wood Block
21	Reed Organ	53	Choir Ahhs	85	Charang	117	Taiko
22	Accordion	54	Voice Oohs	86	Solo Vox	118	Melodic Tom
23	Harmonica	55	Synth Voice	87	5th Saw Wave	119	Synth Drum
24	Bandoneon	56	Orchestra Hit	88	Bass & Lead	120	ReverseCymbal
25-32	GUITAR	57-64	BRASS	89-96	SYNTH PAD	121-128	SOUND EFFECTS
25	Nylon Guitar	57	Trumpet	89	New Age Pad	121	Gtr.FretNoise
26	Steel Guitar	58	Trombone	90	Warm Pad	122	Breath Noise
27	Jazz Guitar	59	Tuba	91	Poly Synth	123	Seashore
28	Clean Guitar	60	Mute Trumpet	92	Space Voice	124	Birdsong
29	Muted Guitar	61	French Horn	93	Bowed Glass	125	Telephone
30	Overdrive Gtr	62	Brass	94	Metal Pad	126	Helicopter
31	Dist. Guitar	63	Synth Brass 1	95	Halo Pad	127	Applause
32	Gtr.Harmonics	64	Synth Brass 2	96	Sweep Pad	128	Gunshot

Note that the names listed above are as they appear in the KT, and not as they appear in the General MIDI Spec. The only differences are in spelling.

GM and GS Percussion Key Maps (Channel 10)

MIDI Note #		1 - STANDARD-KIT 33 - JAZZ-KIT	9 - ROOM-KIT	17 - POWER-KIT	25 - ELCTRNC-KIT
35	B1	Kick Drum 2	Kick Drum 2	Kick Drum	Kick Drum
36	C2	Kick Drum 1	Kick Drum 1	Mondo Kick	Elec Bass Drum
37	C2+	Side Stick	Side Stick	Side Stick	Side Stick
38	D2	Acoustic Snare	Acoustic Snare	Gated Snare	Electric Snare
39	D2+	Hand Clap	Hand Clap	Hand Clap	Hand Clap
40	E2	Electric Snare	Electric Snare	Electric Snare	Gated Snare
41	F2	Low Floor Tom	Low Room Tom	Low Room Tom	Elec Low Tom
42	F2+	Closed Hi-Hat	Closed Hi-Hat	Closed Hi-Hat	Closed Hi-Hat
43	G2	High Floor Tom	Low Room Tom 2	Low Room Tom 2	Elec Low Tom
44	G2+	Pedal Hi-Hat	Pedal Hi-Hat	Pedal Hi-Hat	Pedal Hi-Hat
45	A2	Low Tom	Mid Room Tom	Mid Room Tom	Elec Mid Tom
46	A2+	Open Hi-Hat	Open Hi-Hat	Open Hi-Hat	Open Hi-Hat
47	B2	Low-Mid Tom	Mid Room Tom	Mid Room Tom	Elec Mid Tom
48	C3	High-Mid Tom	High Room Tom	High Room Tom	Elec High Tom
49	C3+	Crash Cymbal 1	Crash Cymbal 1	Crash Cymbal 1	Crash Cymbal 1
50	D3	High Tom	High Room Tom	High Room Tom	Elec High Tom
51	D3+	Ride Cymbal 1	Ride Cymbal 1	Ride Cymbal 1	Ride Cymbal 1
52	E3	Chinese Cymbal	Chinese Cymbal	Chinese Cymbal	Reverse Cymbal
53	F3	Ride Bell	Ride Bell	Ride Bell	Ride Bell
54	F3+	Tambourine	Tambourine	Tambourine	Tambourine
55	G3	Splash Cymbal	Splash Cymbal	Splash Cymbal	Splash Cymbal
56	G3+	Cowbell	Cowbell	Cowbell	Cowbell
57	A3	Crash Cymbal 2	Crash Cymbal 2	Crash Cymbal 2	Crash Cymbal 2
58	A3+	Vibraslap	Vibraslap	Vibraslap	Vibraslap
59	B3	Ride Cymbal 2	Ride Cymbal 2	Ride Cymbal 2	Ride Cymbal 2
60	C4	High Bongo	High Bongo	High Bongo	High Bongo
61	C4+	Low Bongo	Low Bongo	Low Bongo	Low Bongo
62	D4	Mute High Conga	Mute High Conga	Mute High Conga	Mute High Conga
63	D4+	Open High Conga	Open High Conga	Open High Conga	Open High Conga
64	E4	Low Conga	Low Conga	Low Conga	Low Conga
65	F4	High Timbale	High Timbale	High Timbale	High Timbale
66	F4+	Low Timbale	Low Timbale	Low Timbale	Low Timbale
67	G4	High Agogo	High Agogo	High Agogo	High Agogo
68	G4+	Low Agogo	Low Agogo	Low Agogo	Low Agogo
69	A4	Cabasa	Cabasa	Cabasa	Cabasa
70	A4+	Maracas	Maracas	Maracas	Maracas
71	B4	Short Whistle	Short Whistle	Short Whistle	Short Whistle
72	C5	Long Whistle	Long Whistle	Long Whistle	Long Whistle
73	C5+	Short Guiro	Short Guiro	Short Guiro	Short Guiro
74	D5	Long Guiro	Long Guiro	Long Guiro	Long Guiro
75	D5+	Claves	Claves	Claves	Claves
76	E5	High Wood Block	High Wood Block	High Wood Block	High Wood Block
77	F5	Low Wood Block	Low Wood Block	Low Wood Block	Low Wood Block
78	F5+	Mute Cuica	Mute Cuica	Mute Cuica	Mute Cuica
79	G5	Open Cuica	Open Cuica	Open Cuica	Open Cuica
80	G5+	Mute Triangle	Mute Triangle	Mute Triangle	Mute Triangle
81	A5	Open Triangle	Open Triangle	Open Triangle	Open Triangle
82	A5+	Shaker	Shaker	Shaker	Shaker
83	B5	Jingle Bell	Jingle Bell	Jingle Bell	Jingle Bell
84	C6	Belltree	Belltree	Belltree	Belltree
85	C6+	Castanets	Castanets	Castanets	Castanets
86	D6	Mute Surdo	Mute Surdo	Mute Surdo	Mute Surdo
87	D6+	Open Surdo	Open Surdo	Open Surdo	Open Surdo
88	E6				

GM and GS Percussion Key Maps (Channel 10)

MIDI Note #		26 - TR-808-KIT	41 - BRUSH-KIT	49 - ORCH-PERCSN	128 - MT-32-KIT
35	B1	Kick Drum 2	Kick Drum 2	Concert Bass Drum	Acoustic Bass Drum
36	C2	808 Bass Drum	Kick Drum 1	Concert Bass Drum	Bass Drum 1
37	C2+	808 Rim Shot	Side Stick	Side Stick	Rim Shot
38	D2	808 Snare Drum	Brush Tap	Concert Snare Drum	Acoustic Snare
39	D2+	Hand Clap	Brush Slap	Castanets	Hand Clap
40	E2	Electric Snare	Brush Swirl	Concert Snare Drum	Electric Snare
41	F2	808 Low Tom	Low Floor Tom	Tympani F	Acoustic Low Tom
42	F2+	808 Closed Hi-Hat	Closed Hi-Hat	Tympani F#	Closed Hi-Hat
43	G2	808 Low Tom	High Floor Tom	Tympani G	Acoustic Low Tom
44	G2+	808 Closed Hi-Hat	Pedal Hi-Hat	Tympani G#	Open Hi-Hat
45	A2	808 Mid Tom	Low Tom	Tympani A	Acoustic Mid Tom
46	A2+	80 Open Hi-Hat	Open Hi-Hat	Tympani A#	Open Hi-Hat
47	B2	808 Mid Tom	Mid Tom	Tympani B	Acoustic Mid Tom
48	C3	808 High Tom	High Tom	Tympani C	Acoustic High Tom
49	C3+	808 Cymbal	Crash Cymbal 1	Tympani C#	Crash Cymbal
50	D3	808 High Tom	High Tom	Tympani D	Acoustic High Tom
51	D3+	Ride Cymbal 1	Ride Cymbal 1	Tympani D#	Ride Cymbal 1
52	E3	Chinese Cymbal	Chinese Cymbal	Tympani E	
53	F3	Ride Bell	Ride Bell	Tympani F	
54	F3+	Tambourine	Tambourine	Tambourine	Tambourine
55	G3	Splash Cymbal	Splash Cymbal	Splash Cymbal	
56	G3+	808 Cowbell	Cowbell	Cowbell	Cowbell
57	A3	Crash Cymbal 2	Crash Cymbal 2	Concert Cymbal 2	
58	A3+	Vibraslap	Vibraslap	Vibraslap	
59	B3	Ride Cymbal 2	Ride Cymbal 2	Concert Cymbal 1	
60	C4	High Bongo	High Bongo	High Bongo	High Bongo
61	C4+	Low Bongo	Low Bongo	Low Bongo	Low Bongo
62	D4	808 High Conga	Mute High Conga	Mute High Conga	Mute High Conga
63	D4+	808 Mid Conga	Open High Conga	Open High Conga	High Conga
64	E4	808 Low Conga	Low Conga	Low Conga	Low Conga
65	F4	High Timbale	High Timbale	High Timbale	High Timbale
66	F4+	Low Timbale	Low Timbale	Low Timbale	Low Timbale
67	G4	High Agogo	High Agogo	High Agogo	High Agogo
68	G4+	Low Agogo	Low Agogo	Low Agogo	Low Agogo
69	A4	Cabasa	Cabasa	Cabasa	Cabasa
70	A4+	808 Maracas	Maracas	Maracas	Maracas
71	B4	Short Whistle	Short Whistle	Short Whistle	Short Whistle
72	C5	Long Whistle	Long Whistle	Long Whistle	Long Whistle
73	C5+	Short Guiro	Short Guiro	Short Guiro	Quijada
74	D5	Long Guiro	Long Guiro	Long Guiro	
75	D5+	808 Claves	Claves	Claves	Claves
76	E5	High Wood Block	High Wood Block	High Wood Block	
77	F5	Low Wood Block	Low Wood Block	Low Wood Block	
78	F5+	Mute Cuica	Mute Cuica	Mute Cuica	
79	G5	Open Cuica	Open Cuica	Open Cuica	
80	G5+	Mute Triangle	Mute Triangle	Mute Triangle	
81	A5	Open Triangle	Open Triangle	Open Triangle	
82	A5+	Shaker	Shaker	Shaker	Applause
83	B5	Jingle Bell	Jingle Bell	Jingle Bell	
84	C6	Belltree	Belltree	Belltree	
85	C6+	Castanets	Castanets	Castanets	
86	D6	Mute Surdo	Mute Surdo	Mute Surdo	Wind Chime
87	D6+	Open Surdo	Open Surdo	Open Surdo	
88	E6			Applause	

- There are four additional sounds assigned to keys in the MT-32-KIT:
90 (F6+) Crash 92 (G6+) Train 93 (A6) Jet 94 (A6+) Helicopter

Using General MIDI in the Real World

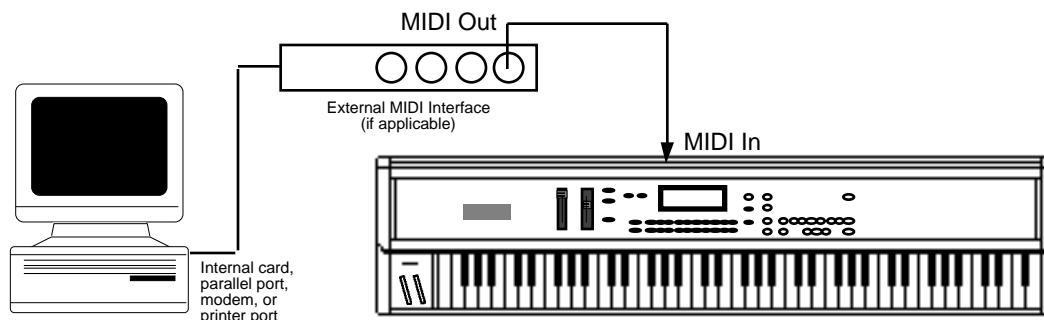

Computer (with MIDI Interface) connected to KT-76 Keyboard

Using KT General MIDI Sounds with an External GM Sequencer

Connecting the KT keyboard to a computer (or other General MIDI sequencer)

1. Power down all electronic devices before making any connections.
2. Using a MIDI Cable, connect the **MIDI In** jack of the KT to the MIDI Out jack of the computer/hardware sequencer/sequence player.

Note: Many computers do not have a MIDI jack built into them, and require an additional MIDI Interface connector between the computer and the KT.

3. Make sure the proper amplification is connected to the KT, and power on the computer, the KT keyboard, and the amplification system (in that order).

Tip: Headphones connected to the **Phones** jack of the KT will work fine in General MIDI mode, and allow you to work late hours without disturbing others.

Enabling General MIDI on the KT

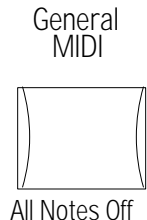

To Enable General MIDI

1. Press the {GENERAL_MIDI} button.

If the sequencer is running, the “SORRY! Sequencer must be stopped.” message will be displayed. You must stop the sequencer to enter General MIDI mode.

If the sequencer is stopped, pressing the {GENERAL_MIDI} button lights its LED, and the KT enters General MIDI mode. Changes made to the current preset/sequence/song will be saved or discarded, according to the setting of the SaveChangesMode parameter (found by pressing the {GENERAL_MIDI} button to exit General MIDI mode, then pressing {EDIT_SEQ/PRESET}, the upper {1}, then the lower {5} button). See Section 11 — Sequencer Parameters for more information about the SaveChangesMode parameter.

2. In General MIDI mode, all buttons except the {CURSOR} buttons, the {VALUE} buttons, the {TRANSPOSE_KEYBOARD} button, and the {GENERAL_MIDI} button are disabled. The KT will display the General MIDI mode page as follows:

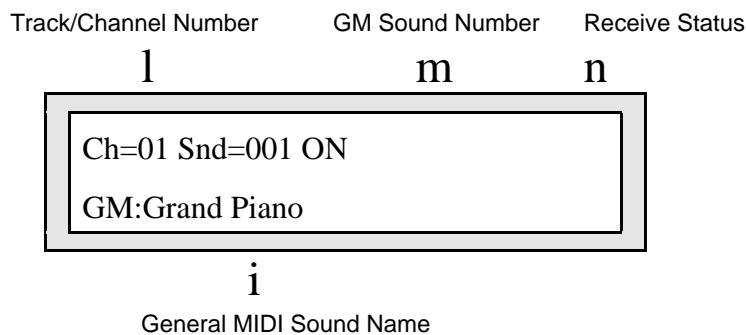

The KT behaves as though an enlarged 16-track sequence has been selected, and as though the current MIDI Mode=MULTI. Incoming MIDI will be received on all 16 MIDI channels, to 16 discrete inbound Track/Channels. The default effect algorithm (EQ-CHORUS + REVERB) will be installed, and all Track/Channels will be routed through the effect.

When you now run the external computer or hardware sequencer, you will hear the proper sounds played from the KT as program changes and note/controller data is transmitted to the KT via the MIDI In jack.

MIDI Out in General MIDI Mode

The KT keyboard will always play the sound assigned to the currently displayed Track/Channel number. Local playing on the KT keyboard and controllers will be transmitted via the MIDI Out jack on the displayed MIDI Channel number. This allows you to connect the KT MIDI Out jack to the MIDI In jack of a computer sequencer/hardware sequencer/other MIDI sound module.

This feature adds MIDI Controller capability to the KT while in General MIDI mode.

KT General MIDI Parameters

Track/Channel Number Range: 01 to 16

This parameter is used to select and view the sounds assigned to each MIDI Channel. When this parameter is selected, the **Data Entry Controls** will scroll through all 16 Track/Channels.

Track/Channel 10 is permanently assigned to play Drum Maps only. When Ch=10 is selected, the GM Sound Number parameter will scroll through the nine available GM/GS Drum Maps. Playing on the KT keyboard will always be transmitted on the displayed MIDI channel.

GM Sound Number Range: 001 to 128

The General MIDI Sound number parameter determines which sound will be assigned to each MIDI channel. When this parameter is selected, the **Data Entry Controls** will change which of the 128 General MIDI ROM sounds is assigned to the currently displayed Track/Channel. The corresponding Program Change message will be transmitted via MIDI whenever this parameter is edited.

Program Changes received on MIDI channels 1-9 and 11-16 will assign programs to the 16 Track/Channels from the 128 General MIDI sounds in ROM. MIDI Channel 10 can only access the nine GM/GS Drum Maps, and will receive the corresponding GS Drum Map Program change value (1=STANDRD-KIT, 9=ROOM-KIT, 17=POWER-KIT, 25=ELCTRNC-KIT, 26=TR-808-KIT, 33=JAZZ-KIT, 41=BRUSH-KIT, 49=ORCH-PERCSN, 128=MT-32-KIT).

The KT keyboard will always play the sound assigned to the displayed Track/Channel number.

Receive Status Range: ON or **

This parameter is set to receive MIDI data by default (ON). By changing the value for each MIDI channel, you can define how many Track/Channels you want to receive data via MIDI.

Setting this parameter to “**” will disable reception of MIDI notes, controllers and program changes on the displayed MIDI channel. Sounds can still be played from the keyboard, and live playing will still transmit via MIDI on the displayed MIDI channel.

When set to “**,” the Track/Channel volume will be set to full on (127), so that your live playing can use the full dynamic range. Resetting the status to ON will reset the Track/Channel volume back to the General MIDI default value of 100.

Tip: When set to **, this parameter allows for “music-minus-one” applications in General MIDI mode. By setting this parameter to **, you disable incoming MIDI for the selected Track/Channel, boost the volume, and can play the assigned sound live from the keyboard as the remaining sequence tracks play back via incoming MIDI.

No matter what the setting of this parameter, a CVP-1 Pedal connected to the CV•Pedal jack will always control the volume of the selected Track/Channel.

Manually Assigning GM Sounds to Each MIDI Channel

1. Use the **Data Entry Controls** to select the GM Sound Number parameter.
2. Use the **Data Entry Slider** or the {VALUE} buttons to scroll through the different GM sounds.

The General MIDI sound names change when you use the **Data Entry Controls**. These sound names and their associated GM Program numbers are listed on the General MIDI Sound Map found earlier in this section.

Note: Most sequence data contains MIDI Program Change messages intended to assign the correct sounds to each MIDI Track/Channel. These incoming MIDI program changes will probably change any manually assigned sounds. If you wish to prevent this from happening, you should disable program change transmission from the external MIDI sequencer.

General MIDI “All Notes Off” button

Some remote MIDI devices may leave notes and controller values “dangling,” causing Track/Channels to function improperly. The KT has a solution to this problem — the General MIDI “All Notes Off” button. Pressing {GENERAL_MIDI} twice will invoke the All Notes Off function:

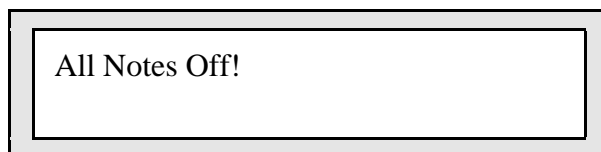

All KT and MIDI voices on all 16 Track/Channels will be silenced. The following MIDI messages will be transmitted on all 16 MIDI channels: All Notes Off, Reset All Controllers, key-ups for all keys down, sustain and sostenuto pedal ups, and controllers will be normalized to the General MIDI default values. Program Changes will be transmitted corresponding to the sounds assigned to each of the 16 Track/Channels.

System and MIDI Control Settings in GM Mode

The following System•MIDI parameter settings are installed in General MIDI mode (see *Section 2 — System•MIDI Parameters* for information about these parameters). All other parameters are reset to values appropriate for General MIDI reception:

- **System•MIDI** page 0, Tune and PTbl settings are retained.
- **System•MIDI** page 1, Touch setting is retained.
- **System•MIDI** page 2, FtswL is set to SOSTENUTO if it was previously set to any value other than UNUSED. If it was set to UNUSED, it will remain UNUSED.
- **System•MIDI** page 2, FtswR is set to SUSTAIN.
- **System•MIDI** page 3, CV-Pedal is set to VOL #7.
- **System•MIDI** page 8, SYS-EX setting is set to ON.

Exiting General MIDI will restore your original settings.

Disabling General MIDI

To Disable General MIDI

Press the {GENERAL_MIDI} button once.

This exits General MIDI mode, momentarily displays “All Notes Off!” turns off its LED, and returns to Sounds mode, with the last Select Sounds mode sound selected.

Note: You can also disable General MIDI by turning the KT off, and then back on. However, any track sound assignments you may have made will *not* be preserved.

Enabling/Disabling General MIDI with System Exclusive Messages

General MIDI can also be enabled/disabled using Universal System Exclusive (SysEx) messages:

Turning General MIDI On using SysEx Messages

F0	7E	<Device ID>	09	01	F7	
F0	7E					Universal non-real-time SysEx header
		<Device ID>				ID of target device (suggest using 7F: Broadcast)
		09				sub-ID #1=General MIDI message
		01				sub-ID #2=General MIDI On
		F7				EOX (end of SysEx)

Turning General MIDI Off using SysEx Messages

F0	7E	<Device ID>	09	02	F7	
F0	7E					Universal non-real-time SysEx header
		<Device ID>				ID of target device (suggest using 7F: Broadcast)
		09				sub-ID #1=General MIDI message
		02				sub-ID #2=General MIDI Off
		F7				EOX (end of SysEx)

More about SysEx Messages

- The System •MIDI page 8, SysEx parameter must be set to ON in order to receive Universal SysEx messages.
- A Universal SysEx General MIDI On message acts the same as pressing the {GENERAL_MIDI} button, and displays the General MIDI mode page. The SysEx message will be ignored if the sequencer is running, or if the system is already in General MIDI mode. Any unsaved edits to the currently selected Preset/Sequence/Song will be saved/discarded according to the setting of the SaveChangesMode parameter.
- If the KT is already in General MIDI mode, a Universal SysEx General MIDI Off message acts the same as pressing the {GENERAL_MIDI} button. This exits General MIDI mode and returns to Sounds mode, with the last Select Sounds mode sound selected.
- When in General MIDI mode, the Universal SysEx General MIDI Off message is the only SysEx message that will be received; all other SysEx messages are ignored.

Sound Canvas MT-32 Mode Program Change Map

The Roland® MT-32 was an early, pre-General MIDI multi-timbral sound module. It used a different MIDI Program Change Map than General MIDI. The Roland Sound Canvas™ provides an MT-32 emulation mode, and some Standard MIDI Files are set up to use this. An MT-32 Program Change Map has been included in the KT to provide Sound Canvas MT-32 emulation capability.

Roland products use the Bank Select MSB (MIDI Controller 0) to change sound banks; in the Sound Canvas, sound bank 127 is designated as the MT-32 Emulation mode bank. After the KT has received a Bank Select value of MSB 127, subsequent MIDI program changes on that MIDI channel will select the GM Sounds remapped to the Roland MT-32 Program Change Map, as below:

PROG #	INSTRUMENT	PROG #	INSTRUMENT	PROG #	INSTRUMENT	PROG #	INSTRUMENT
1	Grand Piano	33	New Age Pad	65	Acoustic Bass	97	Brass
2	Bright Piano	34	Sweep Pad	66	Acoustic Bass	98	Vibraphone
3	ElectricGrand	35	Choir Ahhs	67	Fingered Bass	99	Vibraphone
4	Elec. Piano2	36	Bowed Glass	68	Synth Bass 2	100	Dulcimer
5	ElectricGrand	37	Soundtrack	69	Slap Bass 2	101	Tinkle Bell
6	Elec. Piano1	38	Atmosphere	70	Slap Bass 1	102	Glockenspiel
7	Elec. Piano1	39	Music Box	71	Fretless Bass	103	Tubular Bell
8	HonkyTonk Pno	40	Solo Vox	72	Fretless Bass	104	Xylophone
9	Drawbar Organ	41	Poly Synth	73	Flute	105	Marimba
10	Rock Organ	42	Ice Rain	74	Flute	106	Koto
11	Perc. Organ	43	Poly Synth	75	Piccolo	107	Bandoneon
12	Drawbar Organ	44	Echo Drops	76	Piccolo	108	Shakuhachi
13	Church Organ	45	Bass & Lead	77	Recorder	109	Whistle
14	Church Organ	46	Reed Organ	78	Pan Flute	110	Whistle
15	Church Organ	47	Glockenspiel	79	Alto Sax	111	Bottle Blow
16	Accordion	48	Square Wave	80	Soprano Sax	112	Bottle Blow
17	Harpsichord	49	Strings	81	Tenor Sax	113	Tympani
18	Harpsichord	50	Strings	82	Baritone Sax	114	Melodic Tom
19	Square Wave	51	SynthString 1	83	Clarinet	115	Synth Drum
20	Clavinet	52	Pizzicato	84	Clarinet	116	Synth Drum
21	Clavinet	53	Violin	85	Oboe	117	Synth Drum
22	Clavinet	54	Violin	86	English Horn	118	Taiko
23	Celesta	55	Cello	87	Bassoon	119	Wood Block
24	Celesta	56	Cello	88	Harmonica	120	ReverseCymbal
25	Synth Brass 1	57	Contra Bass	89	Trumpet	121	Wood Block
26	Synth Brass 1	58	Harp	90	Trumpet	122	Tinkle Bell
27	Synth Brass 2	59	Harp	91	Trombone	123	Orchestra Hit
28	Synth Brass 2	60	Nylon Guitar	92	Trombone	124	Telephone
29	Synth Brass 2	61	Steel Guitar	93	French Horn	125	Birdsong
30	Harpsichord	62	Clean Guitar	94	French Horn	126	Breath Noise
31	Saw Wave	63	Clean Guitar	95	Tuba	127	Crystal
32	Synth Bass 2	64	Sitar	96	Brass	128	Breath Noise

After receiving a Bank Select value of MSB 127 on MIDI Channel 10, any subsequent MIDI program changes on MIDI channel 10 will *always* select the MT-32 Drum Map.

Transmitting a Bank Select value of 0-126 MSB will return the MIDI channel to normal MIDI program change reception, selecting sounds from the General MIDI Sound Map as described on the previous page.

MIDI Controller Implementation in General MIDI Mode

When in General MIDI mode, many of the KT controllers function differently than noted in the MIDI Implementation chart, and are described in the following chart.

General MIDI Mode Controller Implementation Chart

Function...	Transmitted	Recognized	Notes
Velocity Note ON Note OFF	YES YES	YES NO ¹	¹ The KT voice architecture does not support Release Velocity.
Aftertouch Key Channel	NO NO	NO NO	
Pitch Bender	YES	YES	Defaults to a value of 64 (center).
Controller 0 (Bank Select MSB)	YES	YES	Always transmitted as 0. An MSB value of 127 received will select the MT-32 Program Change Sound Map.
Controller 1 (Mod Wheel)	YES	YES	Defaults to a value of 0.
Controller 4 (Foot Pedal)	NO	NO	
Controller 6 (Data Entry MSB)	NO	YES	For recognized Registered Parameters only after controllers 100 & 101 are received.
Controller 7 (Volume)	YES	YES	Defaults to a value of 100. Disabling receptor will default the Track/Channel volume to 127. Devices connected to the CV•Pedal jack will control volume.
Controller 10 (Pan)	NO	YES	Defaults to a value of 64 (center).
Controller 11 (Expression)	NO	YES	Defaults to a value of 127. Expression messages received will be responded to as Mix.
Controller 32 (Bank Select LSB)	YES	NO	Always transmitted as 0.
Controller 38 (Data Entry LSB)	NO	YES	For recognized Registered Parameters only after controllers 100 & 101 are received.
Controller 64 (Sustain)	YES	YES	This defaults to a value of 0. The right foot switch will always function as Sustain.
Controller 66 (Sostenuto)	YES	YES	This defaults to a value of 0. The left foot switch can function as Sostenuto, if a stereo foot switch is connected.
Controller 71 (Harmonic Content)	NO	NO	ENSONIQ Timbre.
Controller 72 (Release Time)	NO	YES	Defaults to a value of 64 (center).
Controller 91 (External Effects {Reverb} Depth)	NO	YES	Controls effect bus switching and the FX2 wet/dry mix in the General MIDI effect.
Controller 93 (Chorus Depth)	NO	YES	Controls effect bus switching and the FX1 wet/dry mix in the General MIDI effect.
Controller 100 (Reg Param Select LSB)	NO	YES	Values of 0, 1, and 2.
Controller 101 (Reg Param Select MSB)	NO	NO	
Controller 120 (All Sounds Off)	NO	YES	Responded to as All Notes Off.
Controller 121 (Reset All Controllers)	YES	YES	Reset Controller messages received will normalize only the controllers supported in General MIDI mode. It is received independently on each of the 16 General MIDI Track/Channels.
Controller 123 (All Notes Off)	YES	YES	All Notes Off messages received will be responded to regardless of the setting of the ALL-OFF parameter on the MIDI Control page. It is received independently on each of the 16 General MIDI Track/Channels.
Registered Parameters: 0 Pitch Bend Range 1 Fine Tuning 2 Coarse Tuning	NO NO NO	YES YES YES	These Registered Parameters are received independently on each of the 16 General MIDI Track/Channels.
Program Change	YES	YES	0-127.

Section 13 — Storage

The Storage functions found on Edit Sound page 90 and Edit Seq/Preset page 90 enable you to:

- transfer Sounds or Sequencer data to or from KT-compatible PCMCIA memory cards, and
- transmit dumps containing Sounds or Sequencer data via MIDI System Exclusive messages.

Memory Card Storage

The KT uses industry standard PCMCIA memory cards for sound and sequence storage (the same used by many notebook computers). These cards are readily available through mail-order companies, computer/software stores, and from ENSONIQ (MC-512 and KTC Series).

- The KT will only work with SRAM (Static RAM) PCMCIA Cards.
- The KT will not work with Flash PCMCIA cards.
- The KT can format SRAM PCMCIA RAM Cards ranging in size from 512 KBytes to 2 MegaBytes. However, the KT will always format all cards to the same size (512 KBytes). The ENSONIQ MC-512 cards are of this type.
- The KT will read (but will not write to) the 64 kByte PCMCIA ROM Cards. These ROM cards are used by the ENSONIQ KTC Series sound library. ROM Cards are formatted like RAM Cards, but a:CARD and b:CARD Preset/Seq/Song Banks are smaller.

Installing the Battery in a RAM Card

To maximize battery life, MC-512 (and most SRAM PCMCIA) RAM Cards are shipped without a battery. Before using these cards, you must first install the correct size battery, following the instructions below:

1. Slide the switch away from the battery drawer to release the battery drawer. Note that the other switch is the write-protect switch, and is used to prevent accidental erasure of card files.
2. Pull gently on the plastic tab at the top of the card to open the battery drawer.
3. Insert the battery in the battery drawer with the flat (+) side of the battery facing up.
4. Slide the the battery drawer closed.
5. Slide the switch toward the battery drawer to lock the battery drawer closed.

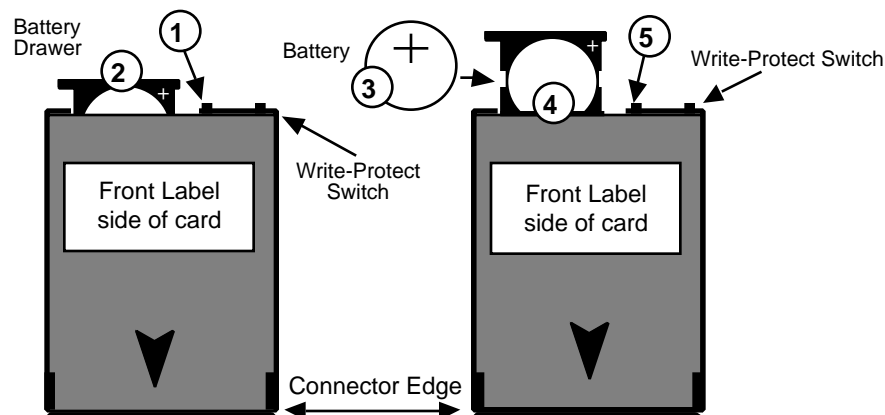

Tip: If you replace the battery while the card is plugged into the KT, with the KT power on, you will not lose the data stored on the card. Do not turn off the KT's power while the card is installed with the battery removed, or any data on the card will be lost.

Memory Card Configurations

PCMCIA (or ENSONIQ MC-512) RAM Cards can be used to store two banks of 80 Sounds (which we refer to as a:CARD and b:CARD), and two banks of 100 Presets/Seqs/Songs (also a:CARD and b:CARD). The 100 Presets/Seqs/Songs available on RAM cards are divided into 70 Presets/Sequences and 30 Songs, just like in the KT (i:INT and r:ROM).

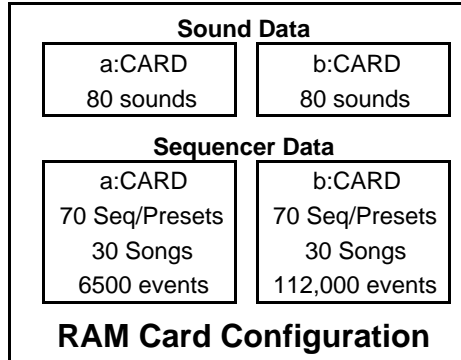

Both sounds and sequencer data stored to a RAM card can be played directly from the card (when it's properly inserted into the card slot on the KT). Each Preset/Seq/Song bank is a world unto itself: for example, songs can only be constructed of sequences from the same bank. The Preset/Seq/Song banks are sized as follows:

- The a:CARD Preset/Sequence/Song bank is formatted to exactly the same size as the i:INT Preset/Sequence/Song bank. It is used mainly for portable backup of the i:INT, and as a transfer area. The a:CARD sequencer bank contains room for 6500 events.
- The b:CARD Preset/Sequence/Song bank is formatted to use all remaining card space assigned for sequencer data storage. The b:CARD sequencer bank contains room for 112,000 events. This is for your big projects. b:CARD stands for BIG!

Formatting a Blank Memory Card

When you first install the battery in a PCMCIA RAM card, the card will not be recognized by the KT until it is formatted. Formatting a card is done by simply copying either the i:INT (Internal) sounds to the a:CARD location (described later in this section), or by saving the internal sequencer memory to the card.

More about PCMCIA RAM Memory Cards

Card Sound Data

- Copying the Internal sounds (i:INT) will put 80 sounds in the a:CARD location, leaving the rest of the card memory empty.
- Once you have copied sounds into the a:CARD location, you can copy another group of sounds to the b:CARD location, or you can save the internal sequencer memory to the card (either a:CARD or b:CARD).

Card Sequencer Data

- Starting from a blank PCMCIA memory card, saving the internal sequencer memory to either the a:CARD or b:CARD location, will format the card, and will copy your data to the selected card sequencer bank. The other card sequencer bank will be initialized with a default seq/preset (location 00) and song (location 70).
- Once you have copied sequencer data into the a:CARD or b:CARD location, you can copy another group of sequencer data to the other location, or you can save the i:INT or r:ROM sounds memory to the card (either a:CARD or b:CARD).

Tip: If there is sound or sequencer data already on a card, you can erase it all by removing the battery for five minutes (exact time varies), and then replacing it.

SOUNDS

Copying Sounds Between Internal and Card Memory

The functions described here are used to do “bulk copies” of the 80 internal (i:INT) sounds to the memory card, or vice-versa. Also, as noted above, it is necessary to copy the internal sounds to the a:CARD location before the card can be used to store sounds at all. If you wish to copy a single sound to a different location, use instead the procedure described in *Section 5 — Understanding Sounds*.

To copy sound banks between Internal and Card memory:

1. Press the {EDIT_SOUND} button.
2. Press the upper {9} button. The display shows:

Press ENTER to Store Sound Data

3. Press {ENTER}. The display now lets you choose which type of storage to use.
4. Use the {VALUE} buttons to select “Storage Type=MEMORY CARD,” as shown below:

Storage Type = MEMORY CARD

5. Press {ENTER}. The display now offers four choices:

Operation = COPY i:INT TO a:CARD	This command copies the entire contents of the internal (i:INT) sound bank to the a:CARD location.
Operation = COPY i:INT TO b:CARD	This command copies the entire contents of the internal (i:INT) sound bank to the b:CARD location.
Operation = COPY a:CARD TO i:INT	This command copies the entire contents of the a:CARD sound bank to the internal (i:INT) memory. This can be useful for copying ROM card data into i:INT (RAM) so that you can edit and save ROM card sounds.
Operation = COPY b:CARD TO i:INT	This command copies the entire contents of the b:CARD sound bank to the internal (i:INT) memory. This can be useful for copying ROM card data into i:INT (RAM) so that you can edit and save ROM sounds.

6. Once you have selected the operation you want from the four options above, press {ENTER}.
7. The copy function is almost instantaneous. The display will read “Command Successful” after the sounds have been copied.

SEQUENCES

Saving Sequencer Data to a PCMCIA Memory Card

You can save the contents of the KT sequencer memory to a PCMCIA (or an MC-512) RAM card.

To Copy sequencer memory between Internal and Card memory:

1. Press the {EDIT_SEQ/PRESET} button.
2. Press the upper {9} button. The display shows:

Press ENTER to Store Seq Data

3. Press {ENTER}. The display now lets you choose which type of storage to use.
4. Use the {VALUE} buttons to select “Storage Type=MEMORY CARD,” as shown below:

Storage Type = MEMORY CARD

5. Press {ENTER}. The display now offers four choices:

Operation = COPY i:INT TO a:CARD	This command copies the entire contents of the internal (i:INT) sequencer bank (0-9) to the a:CARD location. Use this when you want to save, or “back up” your sequences and songs to the card.
Operation = COPY i:INT TO b:CARD	This command copies the entire contents of the internal (i:INT) sequencer bank (0-9) to the b:CARD location. Use this when you want to save, or “back up” your sequences and songs to the card.
Operation = COPY a:CARD TO i:INT	This command copies the entire contents of the a:CARD sequence bank to the internal (i:INT) memory. Use this when you want to reload data previously saved to the card.
Operation = COPY b:CARD TO i:INT	This command copies the entire contents of the b:CARD sequence bank to the internal (i:INT) memory. Use this when you want to reload data previously saved to the card.

6. Once you have selected the operation you want from the four options above, press {ENTER}.
7. The copy function is almost instantaneous. The display will read “Command Successful” after the sequencer data has been copied.

About Sequence Memory

The a:CARD sequencer data bank is formatted to exactly the same size as the i:INT sequencer bank, and should be used for portable back-up of the i:INT bank, and as a transfer area. The b:CARD sequencer bank is formatted to use the remaining card space, and is *much* larger than the a:CARD and i:INT sequencer banks.

As a result, it is possible that an attempt to load all sequence data from the b:CARD bank into the i:INT bank will result in the message “Sorry! Seq data too big to save.” Since sequencer data stored to a PCMCIA RAM card can be played directly from the card, this should not be a problem — this is simply a limitation of the storage medium.

Data in the b:CARD sequencer bank can be backed-up via MIDI System Exclusive to any device that can record Sys Ex data (such as an ASR-10, TS-10, or TS-12).

MIDI Sys-Ex Storage

What are System Exclusive Messages?

Some MIDI information—such as key events, controllers, program changes, etc.—is understood by virtually all MIDI devices, regardless of the manufacturer. The common ability to send and receive these messages is what allows you to play any MIDI synth from any other, to change programs and volume remotely, to start and stop sequencers and drum machines together, and the many other performance miracles we have come to expect from MIDI.

There are other messages which each manufacturer has reserved for communicating specific information with a specific machine (or family of machines). These machine-specific messages are called *System Exclusive* (or Sys Ex) messages, since they are meant to be recognized only by a particular device and ignored by all others (i.e., they are exclusive to a particular system).

The KT, for example, can transfer sounds, or sequencer data to another KT. It is a lot like sending a file from one computer to another via modem. The 1's and 0's that make up the data in memory are sent out the MIDI port. This data can be received and understood by another KT, or by a computer running the proper librarian software. Only KT data can be transmitted/received as Sys Ex messages. All other forms will be ignored.

“Generic” System Exclusive Storage

It is not strictly necessary, however, for the receiving system to understand the data it receives, if the purpose is to store it for later reloading into the original system (just as it's not necessary for a file cabinet to understand the pieces of paper you file there). The KT can transmit a MIDI System Exclusive message without the receiving device having the slightest notion of what it means or what type of device it came from. When you want to send the data back to the KT, you just send the data from the remote MIDI device back into the KT, which will then retransmit the message exactly as it was transmitted.

Sending MIDI Sys-Ex Messages to another KT or to a Storage Device

The KT can send MIDI system exclusive dumps of sounds, either singly or in banks, as well as sequencer dumps containing either the entire sequencer memory or the current sequence/song. These dumps can be understood by another KT, or can be recorded by a remote MIDI device that has MIDI Sys-Ex Recorder capabilities (such as the ENSONIQ TS-10, ASR-10, or a computer), to be stored and later retransmitted to the KT.

Banks of sounds or Presets/Seqs/Songs are always transmitted from the currently selected bank (i:INT r:ROM, a:CARD, or b:CARD). The Store Sound Data and Store Seq Data Commands will support Sys-Ex transmission from both the currently selected location, and the currently selected bank (including r:ROM), for Sounds and Presets/Seqs/Songs.

SOUND DATA

Sending One or All Sounds out via MIDI Sys-Ex

1. Press the {EDIT_SOUND} button.
2. Press the upper {9} button. The display shows:

Press ENTER to Store Sound Data

3. Press {ENTER}. The display now lets you choose which type of storage to use.
4. Use the {VALUE} buttons to select “Storage Type=MIDI SYS-EX,” as shown below:

Storage Type = MIDI SYS-EX

5. Press {ENTER}. The display now offers two choices:

Operation = SAVE CURRENT SOUND	This command will transmit the currently selected sound as a MIDI System Exclusive message. The sound to be transmitted can be in any bank, including the i:INT, r:ROM, a:CARD or b:CARD banks.
Operation = SAVE i:INT SOUND BANK	This command transmits the entire contents of the i:INT internal RAM sounds bank as a MIDI System Exclusive message. The dump contains data for the complete set of 80 internal sounds.

6. Once you have selected either SAVE CURRENT SOUND or SAVE i:INT SOUND BANK, press {ENTER}. The display will show “Please wait . . . sending data” while the data is being transmitted. When the transfer is complete, the display will return to the “Press ENTER to Store Sounds” display.

SEQUENCER DATA

Sending Sequences/Songs out via MIDI Sys-Ex

1. Press the {EDIT_SEQ/PRESET} button.
2. Press the upper {9} button. The display shows:

Press ENTER to Store Seq Data

3. Press {ENTER}. The display now lets you choose which type of storage to use.
4. Use the {VALUE} buttons to select “Storage Type=MIDI SYS-EX,” as shown below:

Storage Type = MIDI SYS-EX

5. Press {ENTER}. The display now offers two choices:

Operation = SAVE CURRENT SEQ/PSET	This command will transmit the currently selected sequence or song as a MIDI System Exclusive message.
Operation = SAVE CURRENT SEQ BANK	This command will transmit the entire contents of the currently selected seq/preset bank as a MIDI System Exclusive message. The dump contains data for the complete set of 70 sequence locations and 30 song locations.

6. Once you have selected either SAVE CURRENT SEQ/PSET or SAVE CURRENT SEQ BANK, press {ENTER}. The display will show “Please wait . . . sending data” while the data is being transmitted. When the transfer is complete, the display will return to the “Press ENTER to Store Sequences” display.

Receiving MIDI Sys-Ex Messages

The receiving of data dumps is initiated automatically by System Exclusive messages sent from the transmitting unit. No front panel commands are necessary to receive dumps if the receiving of System Exclusive messages is enabled. When Sys-Ex data for a bank of sounds is received via incoming MIDI, it will always be written to the i:NT Sounds bank. When Sys-Ex data for a bank of presets/seqs/songs is received via incoming MIDI, it will be written to the currently selected Seq/Preset bank (if it's r:ROM, it will be ignored).

To Enable Reception of System Exclusive messages:

1. Press the {SYSTEM" MIDI} button.
2. Press the lower {8} button.
3. Using the **Data Entry Controls**, set "SysEx=ON."

When a single-sound MIDI Sys-Ex message is received, three things happen:

- the display briefly shows "Press ENTER to Save New Sound".
- the new sound is placed in the edit buffer.
- the KT enters Edit Sound mode, with the **Edit Sound** LED flashing, so that you can hear, edit and/or save the new sound that has been received.

When a one-Seq/Song message is received, the new sequence will be placed in the lowest-numbered empty sequence location in the current sequencer bank. Or, if a song is received, it will be placed in the lowest-numbered empty song location in the current sequencer bank. After it is received, the new sequence or song will be selected.

Storage Prompts and Error Messages

These messages are displayed for one second and indicate either successful completion or non-fatal error conditions encountered during a storage operation:

Command successful!	This message indicates that the storage operation was completed successfully and without errors.
SORRY! Install a RAM card first.	This message appears if you attempt to copy i:INT TO a:CARD or i:INT TO b:CARD when there is no card installed, or when a ROM (Read Only Memory) card is installed.
SORRY! Install a card first.	You will get this message if you attempt to copy a:CARD TO i:INT or b:CARD TO i:INT when there is no card installed.
SORRY! Write to a:CARD first.	This message appears if you attempt to copy i:INT TO b:CARD before you have copied sounds to the a:CARD bank. The a:CARD bank must be written before you can copy sounds to the b:CARD bank.
SORRY! a:Card Sound Bank empty	You will get this message if you attempt to copy a:CARD TO i:INT when the card is formatted but does not contain sound data in the a:CARD bank.
SORRY! b:Card Sound Bank empty	You will get this message if you attempt to copy b:CARD TO i:INT when the card is formatted but does not contain sound data in the b:CARD bank.
SORRY! Card Seq Banks are empty.	You will get this message if you attempt to copy either a:CARD TO i:INT or b:CARD TO i:INT when the card is formatted but does not contain any sequencer data.
SORRY! Write to card failed.	This message will appear whenever the KT fails to verify data that it has written to the card. It could mean that the card is a ROM card and cannot be written, or that the card is write-protected or possibly defective.
SORRY! Seq data too big to save.	This will be displayed if the Preset/Seq/Song data being saved won't fit into the target memory location. This applies to card data and Sys-Ex data received.
SORRY! Card is Write-Protected.	This message will be displayed if the currently installed card is write-protected, or if it's a ROM card, and you try to write to the card, either manually from RAM, or remotely via incoming MIDI Sys-Ex.
Card Battery Low See manual!	If this message appears when a RAM card is inserted into the card slot, it means that the battery in the card is getting low and should be replaced as soon as possible. To replace the battery, see earlier in this section under "Installing the Battery in a RAM Card." If you replace the battery while the card is plugged into the KT, with the KT power on, you will not lose the data stored on the card. Do not turn off the KT's power while the card is installed with the battery removed, or any data on the card will be lost.

Appendix

KT MIDI Implementation

The KT features an extensive MIDI (Musical Instrument Digital Interface) implementation. For normal applications, you will find all the information you need regarding the KT's MIDI functions in this manual. You can also refer to the MIDI Implementation Chart on the next page for a summary of the KT MIDI implementation.

If you are writing a computer program to communicate with the KT via MIDI, or otherwise require a copy of the full KT System Exclusive Specification, it is available free of charge by writing to:

ENSONIQ Corp
MIDI Specification Desk
155 Great Valley Parkway
P.O. Box 3035
Malvern PA 19355-0735
USA

Include in your written request your name and address, and indicate that you would like a copy of the "KT System Exclusive Specification." Please allow 2 to 3 weeks for delivery.

Registered Parameters

Registered parameters are transmitted (as four sequential continuous controller messages) by the KT whenever certain parameters are edited from the front panel. The two registered parameter controllers select the parameter and the following two data entry controllers specify the value.

Controllers		
Number	Name	Value
100	Registered Parameter Select LSB	00 or 01
101	Registered Parameter Select MSB	always 0
6	Data Entry MSB (Most Significant Byte)	(see below)
38	Data Entry LSB (Least Significant Byte)	(see below)

Registered Parameters		
Number	Name	KT parameter range
00	Pitch Bend Range	0..12
01	Fine Tuning	0..255 (displayed -99..+99)
02	Coarse Tuning (GM Mode only)	0..127 (displayed -64..+63)

In most system modes, registered parameters 0 and 1 affect System page Tune & Bend parameters respectively when received on the base MIDI channel only. In General MIDI mode, registered parameters 0, 1, and 2 are received multi-timbrally, and affect each Track/Channel independently.

The parameter values are sent as two Data Entry controller messages:		
Parameter	Data Entry MSB (6)	Data Entry LSB (38)
Pitch Bend Range	0..12	0
Master Tune	0..127 (internal bits 1..7)	64 or 0 (internal bit 0)

For Fine Tuning, which is an 8-bit value internally, the most significant 7 bits are offset by 64 and shifted once before being sent as Data Entry MSB (Controller 6). The least significant bit of the internal value is transmitted as bit 6 of Data Entry LSB (Controller 38).

MODEL: KT

MIDI Implementation Chart

Version: 1.0

Function...	Transmitted	Recognized	Remarks
Basic Channel Default Channels	1 1-16	1 1-16	
Mode Default Messages Altered	1 X X	1, 3, 4, MULTI X X	current mode is memorized Global Controllers in MONO Mode
Note Number True Voice	21-108	21-108	
Velocity Note ON Note OFF	O O	O X	
After Touch Key Channel	X O	O O	PolyKey pressure
Pitch Bender	O	O	
Control Change	0 Bank Select MSB ² 1 Mod Wheel 4 Foot (Pedal) 6 Data Entry MSB ³ 7 Volume 32 Bank Select LSB 38 Data Entry LSB ³ 64 Sustain 66 Sostenuto 71 Harmonic Content ⁴ 72 Release Time 100 Reg. Param. Select LSB ⁵ 101 Reg. Param. Select MSB ⁶	0-127 External Controller ¹ 0 Bank Select MSB 1 Mod Wheel 4 Foot (Pedal) 6 Data Entry MSB ³ 7 Volume 10 Pan 32 Bank Select LSB 38 Data Entry LSB ³ 64 Sustain 66 Sostenuto 71 Harmonic Content ⁴ 72 Release Time 100 Reg. Param. Select LSB ⁵ 101 Reg. Param. Select MSB ⁶	¹ assignable XCtrl ² always 0 ³ for Reg. Params only after 100 & 101 are transmitted or received. ⁴ Timbre ⁵ values of 0 & 1 only ⁶ always 0
Program Change True Number	0-127	0-99	
System Exclusive	O	O	see KT SysEx Spec.
System Common : Song Pos : Song Sel : Tune	O O X	O O X	
System Real Time : Clocks : Commands	O O ⁷	O O ⁷	⁷ Start, Stop, Continue
Aux. Messages : Local On/Off : All Notes Off : Active Sense : Reset	X X X X	X O ⁸ X X	⁸ In MULTI and MONO-B modes.
Notes	Refer to <i>Section 12 — The MIDI Connection</i> for information about Controller Implementation in General MIDI mode.		

Mode 1= OMNI ON, POLY
Mode 3= OMNI OFF, POLY

Mode 2= OMNI ON, MONO
Mode 4= OMNI OFF, MONO

O = YES
X = NO

KT Index

0 to 9 Buttons 4
8-VOICE CHORUS 53

A

A=440 21
AC line voltage iv
AcBass/Kybrds(i) 143
ADD 190
ADSR 77
After-touch 11, 76
Algorithms 49
 Defined 40
 Listing 42
 Programming 41
All Notes Off 245
Alpha 24
AM Min and Max 61
Amp pages 119
Amplification
 Using with KT v
Append Sequence 210
Atck 57
AtckV 92
Audio outputs 2
Audition 167
Auto Locate 183
Auto Punch 185, 187, 191
AutoStep 189

B

Bank
 Button 4
 Location 183
 Select messages 36, 150
 Select MSB 247
Banks
 About 4
 Direct-Dialing 4
Bar/Beat 184
Base Channel 31
 Pressure 32
Battery vii
Beta 24
Bnd 22
Breath Controller 75
Bus 42
Busses 122
Button Names x
BW 50

C

Card 135
 Memory 157, 250
 Sounds 135
Carlos 24
Chaining 174
Chan 149
Change Length 211
Channel Pressure 11, 32, 76
Channels 129
Chorus
 Center 53, 54, 65
 Depth 53, 54, 65
 Feedback 53
 Level 54, 66
 Rate 53, 54, 65
Cleaning the KT ii
Click
 Pages 195
 Pan 195
 Parameter 195
 Volume 195
Clipping 104, 121
Clock 191
Color-coded text x
Color-coding x
 Scheme 3
Command successful! 257
Compare Button 5
 About 68
Compression 63
Constant-Time Portamento 90
Controller 7, 4
 Fights 173
 Numbers 34
Controllers 35
 Routed to Effects 173
Copy Preset Data 141, 199, 209
Copy Sequence 206
Copy Song 197
Copy Track 219
Countoff 188
Create Sequence/Preset 205
Create SONG/Pset 196
Current Seq Bank Free Memory 194
Cutoff frequency 102
CV pedal 2, 30, 57
CVP-1 Control Voltage Foot Pedal xi, 2, 30, 75,
 180

D

Data Editing 18
 DDL
 Regen 55
 Send 55
 Time 55
 DDL-CHORUS+REVB 56
 Decay
 Bias 45, 51
 Parameter 57
 Time 52, 64
 Default Envelope Values 96
 Default Preset template 139
 Delay Time 83, 181
 Delay Times/Tempo BPM Chart 180
 Demo Song 16
 Destination Bus 42
 Detune Depth 52
 Detune Rate 52
 Diffusion 52
 Digital Oscillator Chip 39
 Digital Sequencing 155
 Direct-Dialing 14, 17, 161
 Banks 4
 Direction 83
 Display 4
 Dist 65
 Distortion 61
 Level In/Out 63
 DISTWAH-CHO+REVB 65
 Doppler 61
 Double-click 132
 Drum machine 234, 235
 Sequencing from a track 235
 Syncing the KT to a 234
 Syncing to the KT 234
 Drum Sound 111
 About 71
 Creating 123
 Saving 125
 Setting Key Ranges 124
 Voice Architecture 71
 Wave list 114
 DRY 42
 DRY/BYPASSED 49
 DUAL EQ+REVERB 50

E

Edit
 Buffer 68
 (Drum) Sound mode 111
 (Standard) Sound mode 79
 Seq/Preset Button 6

Song Steps 200, 202
 Song Steps page 175
 Sound 68
 Sound Button 6
 Times 186
 Track 136
 Track Button 6
 Track mode 145
 EDITS AUTO-SAVED 192
 Effect
 Algorithms 49
 Modulators 46
 Selector 41
 Effects 39
 Listing 42
 Mixing 42
 Multiple function routing 43
 Parameters 49
 Signal routing between 40
 Single function routing 43
 Understanding 39
 ElBass/Kybrds(i) 143
 ElecBass/Gtrs(i) 143
 ENSONIQ drum map 117
 Env Amt 57
 Env Pages 91
 ENVCF-CHO+REVERB 57
 Envelope
 Diagram 77
 Envelopes
 ADSR 77
 Default Values 96
 Defined 77
 ENV 1 74, 77
 ENV 2 74, 77
 ENV 3 74, 77
 Preset Defaults 95
 EQ-CHORUS+REVERB 54
 EQ-DDL+REVERB 55
 Equal-temperament tuning 22
 Erase Sequence/Preset 207
 Erase Song/Preset 198
 Erase Track 220
 ESP chip 39
 Event Edit Track 215
 Event — Event Type Filter 215
 Events 155
 EVS-6 xi
 External controller 75
 External MIDI controllers 34

F

Fc 57, 65
 Feedback 54, 59, 60, 66
 Filter 61
 Cutoff frequency 100
 Events 225
 Pages 100, 119
 Filters 100
 About high pass filters 102
 About low pass filters 102
 Configurations 103
 To change the cutoff frequency 102
 To Modulate 102
 What is a Pole 102
 Fine 88
 Fixed Gate Duration 189
 FL-CMP-DIST+REVB 63
 Flange
 Center 59
 Depth 59
 Rate 59, 63
 FLANGER+REVERB 59
 Fly
 On the 186
 FM Min and Max 61
 Foot Switch 1
 FtswL 1, 29
 FtswR 1, 29
 Front panel 3
 Diagram 3
 FX1 42
 FX1 F 50
 FX1 L/R Routing 65
 FX2 42
 FX2 F 50

G

Gain 50
 Gamelan 23
 Gamma 24
 Gate 189
 General MIDI
 Button 5
 Controller Implementation 248
 Cool Logo 237
 Defined 237
 Disable 246
 Drum Map 115
 Hidden 116
 Enable 243
 GS/MT-32 Compatibility 237
 MIDI Out 243
 Percussion 237

Requirements 237
 Sound Map 237, 239
 Using 242
 Why use 238

Glide
 Modes 90
 Parameter 90
 Time 90
 Global controllers 34
 GM Map 115
 Goto function 184
 Ground Loops
 About Ground Loops iv
 GS Drum Maps 237

H

Headphone
 Impedance warning 10
 Headphones 10
 HF Bandwidth 52
 HF Damping 52, 64
 Hidden ROM General MIDI Drum Map 116
 HiPass Cutoff 63
 Home stereo vi

I

ID 37
 Import Sequence 212
 Import Song 203
 Inertia 61
 INHARMONIC 81
 Input Invert 59, 60
 INSERT Bars 211
 INSERT/REMOVE 202
 Internal clock 191
 Interval 195

K

Kbd Amt 58
 Keep NEW/OLD page 167
 Key Down event 155
 Key Groups
 Defined 114
 Key Range 147, 215
 Setting a 147
 Key Up event 155
 KEYBD 46
 KeybdScale 105
 Keyboard
 Filter tracking 101
 Layouts 147
 Pitch Tracking 89, 118

- Splits
 - Creating 148
- Stands ii
- Tracking 76
- Transpose 8
- KeyRange 107
- KTC Series ROM Cards xi

L

- Latching Pressure with Sustain or Sostenuto 29
- Layer Lock 137
- Layering 132
- Left foot switch 29
- Left/Mono Output 2
- LEGATO 90
- Legato Envelope/Wave Retrigger 90
- Legato Glide 90
- Levels 91
- LevV 92
- LFO 74, 89, 97
 - Frequencies 97
 - Pages 97
 - Rate 97
- Line Conditioner iv
- Line-level vi
- Locate information ix
- Locate page 183, 184
- Lock 137
- LOOP 188
 - MIDI Loop 38
- LOOPED 190
- LoPass Cutoff 64
- Low Frequency Oscillator 74, 97

M

- Make Default Preset
 - Button 7
 - Making a template 139
 - Playing the demo 139
 - Using the button 139
- Master tuning 21
- MC-512 RAM 10
- MC-512 RAM Cards xi
- Memory 13
- Merge Track 221
- Metronome 195
- Mic-level input vi
- MIDI
 - About 229
 - Assigning reception channels 233
 - Bank Select 36
 - Breath Controller 75
 - Channel 149

- Assignments 234
- Clock 191
- Connection 229
- Connections 1
- Controller application 231
- Devices
 - Connecting 229
 - Controlling from the KT 229
- Guitar controller 236
- Implementation Chart II
- In 1
- Loop 38
- Mode 33
- Mode and Channel 230, 234
- Out 1
- Parameters 21, 31
- Powering Up vi
- Program change 35
- Program Change number 149
- Song position pointers 235
- Song Select messages 37
- Song Selects 235
- Status 32, 151, 229
- System Exclusive 37
- Thru 1
- Track configuration 235
- Tracks 171
 - Recording 171
- TrkName 38
- Using external sequencers 232
- MIDI-Blend 142
- MINIMODE 90
- Mix 62, 65
- Mixdown 178, 190
 - Mode 180
 - Track 178
- Mode 3, 84
- Modulation
 - About 73
 - Amount 46
 - Destination 46
 - Source 46
 - Sources 74
 - Wheel 75
- Modulation (Mod) Wheel 11
- Modulators 74
- MONO mode 33
- Mono pressure 11, 76
- MS-1 Music Stand xi
- MT-32 237, 247
- MULTI mode 33, 232
- Multi-sampled 81
 - Waves 84
- Music software 238

N

Noise generator 74
 Noise Rate 97
 Notch Depth 59, 60
 Note memory 90
 Number of clocks to shift by 223

O

Oct 88
 OhSoSweet-Rhodes 142
 Optional accessories xi
 OTTO 39
 Out 50, 51
 Output 104, 146
 Bus 108, 122
 Pages 104, 121

P

Page
 Defined 4
 Location headings ix
 Pages
 About ix
 Pan 109, 145
 Parameter
 Changing a 18
 To change a 19
 Parameters
 Multiple 19
 Parametric Programming 18
 Partch 24
 PBEND 46
 PCMCIA
 Card 10
 Card Slot 10
 RAM or ROM cards 10
 PEDAL 46, 75
 Pelog 23
 Percussion Key Map 237
 Performance
 Controllers 11
 Memories 127
 Parameters 136
 Accessing 136
 Phaser
 Center 60
 Depth 60
 Rate 60
 PHASER+REVERB 60
 Phones 10
 PITCH 75
 Pitch bend 22

Wheel 11, 75
 Pitch page 118
 Pitch pages 88
 Pitch-table 22
 Parameter 22
 Various 22
 Pitch-tables
 Arabic
 ARABIC-1 23
 ARABIC-2 23
 ARABIC-3 23
 ARABIC-4 23
 Chinese
 CHINESE-1 23
 CHINESE-2 23
 Equal stepped
 19-TONE-EQU 24
 24-TONE-EQU 23
 31-TONE-EQU 24
 53-TONE-EQU 24
 Greek
 GRK-CHROMAT 22
 GRK-DIATONC 22
 GRK-ENHARM 22
 HARMONIC 24
 INDIAN-RAGA 23
 Java
 JAVA-COMBI 23
 JAVA-PELOG1 23
 JAVA-PELOG2 23
 JAVA-PELOG3 23
 JAVA-SLNDRO 23
 JUST INT-C 22
 MEANTONE-C 22
 NORMAL 22
 PARTCH-43 24
 PYTHAGRAN-C 22
 REVERSE 24
 THAILAND 23
 TIBETAN 23
 TURKISH-A 23
 VALLOTTI-C 22
 Wendy Carlos
 CARLOS-BETA 24
 CARLOSALPHA 24
 CARLOSGAMMA 24
 WRKMEISTR-C 22
 Pno/SoloHorns(i) 144
 PnoStr/Orch (i) 144
 Polarization iii
 Pole 102
 Poly-Key™ Pressure 11, 76
 Poly-rhythms 181
 Polyphonic pressure 11, 32, 76
 Polyphony

- Understanding 67
- Portamento 90
- Power iii
- Preset
 - Copy data 199, 209
 - Creating for MIDI sequencing 233
- Preset/track parameters 145
- Presets 127
 - Creating a 130
 - Building your own 130
 - Modify an existing preset 131
 - Using the default preset 130
 - Described 128
 - How Many 127
 - How to make 139
- ROM
 - Defined 142
 - Selecting 16, 127
 - Selecting ROM 142
- PRESSR 46
- Pressure 11, 25, 32, 76, 152
 - Latching 29
- Priority 108
- Prog 149
- Prog Change 35
- Program changes 149
 - Recording into the Sequencer 169
- Punch In 168, 185
- Punch In times
 - Setting in real time 186
- PUNCH OUT 186
- Pythagorean 22

Q

- Qc 57, 65
- Quantize to nearest 227
- Quantize Track 227
- Quick-Start Guide ii

R

- Ragas 23
- RAM Card Configuration 157
- Ramps 46, 47
- Real World 242
- Rear panel
 - Connections 1
 - Diagram 1
- Reboot viii
- Record 190
- Registered Parameter Select 21, 22
- Reinitializing viii
- Release 154
- Rels 57

- Remote MIDI Devices
 - Controlling 230
 - Set up 230
- REMOVE Bars 212
- Rename SEQ/Preset 208
- Rename SONG/Pset 199
- Rep 201
- REPLACE 190
- Replace Track Sound
 - Button 7
 - How to 133
 - How to replace a sound along with its effect 134
- Replace w/FX 134
- Replacing Sounds 135
- Resources
 - Additional xi
- Restrike 85
- Rev 51
- Reverb to Cmprss Feedback 64
- Reverb variations 45
 - AMBIENCE 1 45
 - AMBIENCE 2 45
 - BRITEHALL 45
 - BRITEPLATE 45
 - CANYON 45
 - DARK PLATE 45
 - EARLY REFL 45
 - INVERSE RM 45
 - LONGPLATE 45
 - MED.HALL 45
 - MED.ROOM 45
 - SMALL HALL 45
 - STONEHALL 45
 - STRNGHALL 45
 - WAREHOUSE 45
 - WARM ROOM 45
- Right /Mono Output 2
- Right foot switch 29
- ROM Drum Map 116
- ROM Presets 142
- ROTARY SPKR+REVB 61
- Rotor Speed 61

S

- Sample Shift 84
- Save Changes 192
 - About 170, 193
 - Mode 192
 - Page
 - About 138
- Scale Track 224
- Select Seq/Preset Button 5
- Select Sequence Mode Pages 160

- Select Sound Button 3
- Semi 88
- SEQ (or SONG) PUNCH IN 185
- SEQ (or SONG) PUNCH OUT 186
- Sequence
 - Append 210
 - Change Length 211
 - Command pages 205
 - Copy 206
 - Defined 128, 156
 - Effect 39
 - Goto control 184
 - Import 212
 - Info 208
 - Location 183
 - Status 183
- Sequencer
 - Control pages 188
 - Creating a song 163
 - Erasing memory 194
 - Free memory 194
 - Memory Configuration 16, 157
 - Parameters 183
 - Selecting 160
 - Status 159
- Sequencer/Presets Track Buttons 7
- Sequences
 - Creating a 162
 - How to erase all 164
 - How to record 165
 - Playing 161
 - Re-recording a track 168
 - Record Additional Tracks 167
 - Record the First Track 166
 - Select a Sound for the Track 165
 - Select a Track 165
 - Selecting 16
- Set Track Range 214
- SHIFT ALL 84
- Shift Track 223
- SHOW PROMPT 192
- Signal processor 39
- Slendro 23
- Song
 - Assembling a 174
 - Command pages 196
 - Defined 156
 - Edit Tracks Displayed 178, 192
 - Erase 198
 - Import 203
 - Information 198
 - Position Pointer 235
 - Rename 199
 - Tracks 177
 - Uses effect from 191
- Song mode
 - Definition 174
 - Switching Effects in 176
 - Viewing sequence tracks 178
- Song Select 37
- Song Steps
 - Editing 202
- Songs
 - Selecting 16
- SOSTENUTO 29
- Sound
 - Canvas™ 247
 - Effects 39
 - Memory Configuration 13
 - What is a KT Sound 67
- SoundFinder 86
 - About 15
 - Presets 133
- SoundFinder Type 86
 - ACOU BASS 86
 - ACPIANOS 86
 - ALTKEYS 86
 - ALTPLUCK 86
 - BELL 86
 - BRASSECT 86
 - CUSTOM 86
 - ELECBASS 86
 - ELPIANOS 86
 - GUITARS 86
 - HYBRDLYR 86
 - MALLET 86
 - ORGANS 86
 - OTHER 86
 - PERCUSSN 86
 - SOLOBRAS 86
 - SOLOSAX 86
 - SOLOSTRG 86
 - SOLOWIND 86
 - SOUND-FX 86
 - SPLITS 86
 - STRGSECT 86
 - SYNBASS 86
 - SYNLEAD 86
 - SYNOTHER 86
 - SYNPAD 86
 - TUNEPERC 86
 - UTILITY 86
 - VINTGSYN 86
 - VOCALS 86
 - WINDSECT 86
- Sounds
 - Changing Locations 69
 - Saving to Memory 69
 - Selecting 12
- Speed Max 61

Speed Min 61
 Splits 147
 Srutis 23
 Staccato Glide 90
 Standard sound 70
 Start Index 83
 Status 32, 151, 201
 Step 190, 201
 Step Entry 188
 Stereo bus 42
 STOP/CONT 29
 STRETCH ONE 84
 Sub-pages
 About ix
 Surge/Spike Suppressor iv
 Sust 57
 SUSTAIN 29
 Sustain Pedal 153
 SUSTN 46
 SW-2 29
 SW-6 Single Foot Switch 1, 29, 158
 SW-10 Dual Foot Switch xi, 1, 29, 158
 SynBass/Kybds(i) 143
 SysEx 37
 System Exclusive messages 37, 246
 Defined 253
 System Exclusives
 Generic 253
 System•MIDI
 Button 6
 Mode 21

T

Tap
 Spinal 63
 Tempo 187
 Temperature Guidelines v
 Template 128
 Tempo 187, 195
 Tetra chord 22
 Thailand 23
 TIMBRE 46, 75, 154
 TinePno/Horns(i) 144
 Touch 25
 Track 129, 156
 Command pages 214
 Copy 219
 Described 129
 Erase 220
 Merge 221
 Mute Status 172
 Quantize 227
 Range 214
 Replacing sounds 133

Scale 224
 Shift 223
 Status 32, 228
 Transpose 222

Tracks

Layering 132
 Mixing, Muting, and Soloing 172
 Recording MIDI 171
 Volume Functions 172
 Transport Controls 7, 158
 Transpose 148, 201
 Transpose Keyboard 8, 9
 Button 8
 Transpose Track 222
 TRANSWAVE 81, 83
 Trig Mode 57
 TRIGGER 90
 Tufnel theorem 63
 Tune 21

U

U-SAVE MANUALLY 192
 Unexpected Event messages viii
 UNUSED 29

V

Vel Window 109
 VelCurv 92, 122
 VELOC 46
 Velocity 76
 Curve Diagram 26
 Curves 25
 Level 92
 Level Control 120
 Response 25
 Response Curves 26, 92, 122
 Vibrato 89
 Voice
 Allocation 67
 Configuration Chart
 Drum Sound 71
 Standard Sound 70
 Muting 30
 Restrike Decay Time 85
 Status 80
 Stealing 93, 120
 Voices
 Understanding 67
 Vol 121
 Volume 145
 Volume Slider vi

W

Wah

Modulaton note 66

Walkman™ 10

WARM CHAMBER 52

Wave classes 81

Wave pages 79, 111

WAVE-LIST 82

WAVEFORM 81

Waves 79

Wedding Ceremony 144

Weighted-action i

Werkmeister 22

WHEEL 46, 75

WHL+PR 75

X

XCtrl 34, 46, 75

Index