

**ATARI**

**520ST™**  
COMPUTER

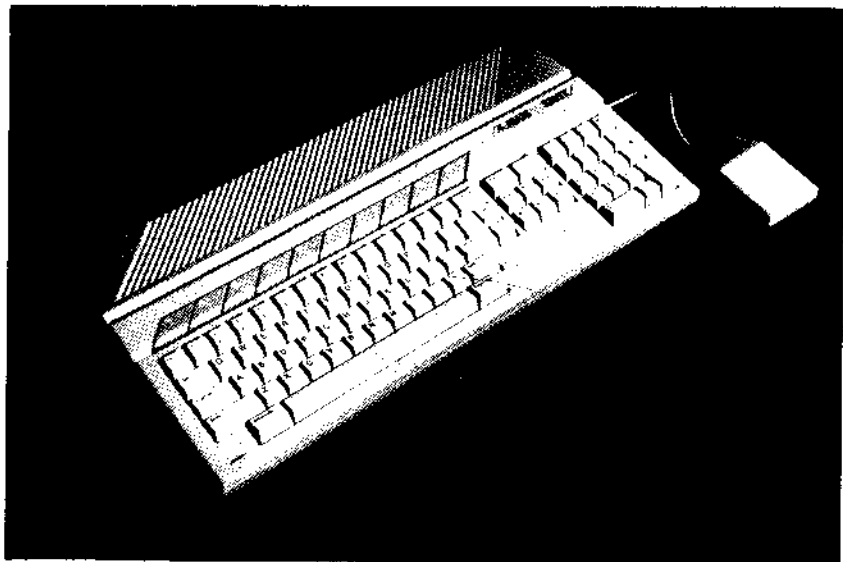

OWNER'S MANUAL

## IMPORTANT INFORMATION

Like any electrical appliance, this ATARI 520ST Computer uses and produces radio-frequency energy. If it is not installed and used according to the instructions in this guide, the equipment may cause interference with your radio or television reception.

If you believe that this equipment is causing interference with your radio or television reception, try turning the equipment off and on. If the interference problem stops when the equipment is turned off, then the equipment is probably causing the interference. With the equipment turned on, you may be able to correct the problem by trying one or more of the following measures:

- Reorient the radio or television antenna.
- Reposition the equipment in relation to the radio or television set.
- Move the equipment away from the radio or television.
- Plug the equipment into a different wall outlet so that the equipment and the radio or television are on different branch circuits.

If necessary, consult your ATARI Computer retailer or an experienced radio and television technician for additional suggestions.

Another helpful resource is *How to Identify and Resolve Radio-TV Interference Problems*, a booklet prepared by the Federal Communications Commission. This booklet is available from the U.S. Government Printing Office, Washington, DC 20402, Stock No. 004-000-00345-4.

**WARNING:** This equipment has been certified to comply with the limits for a Class B computing device, pursuant to Subpart J of Part 15 of FCC Rules. These rules are designed to provide reasonable protection against such interference when the equipment is used in a residential setting. However, there is no guarantee that interference will not occur in a particular home or residence. Only peripherals (computer input/output devices, terminals, printers, etc.) that have been certified to comply with the Class B limits may be attached to this computer.

Operation of noncertified peripherals with this computer is likely to result in interference with radio and TV reception. Shielded cables should be used on all I/O connectors (except the joystick and mouse connectors); otherwise, radio emissions may exceed FCC Class B limits.

Every effort has been made to ensure the accuracy of the product documentation in this manual. However, because we are constantly improving and updating our computer software and hardware, Atari Corp. is unable to guarantee the accuracy of printed material after the date of publication and disclaims liability for changes, errors, and omissions.

ATARI, ATARI BASIC, ATARI Logo, SC1224, SF314, SF354, SM124, ST and 520ST are trademarks or registered trademarks of Atari Corp.

Centronics is a registered trademark of Centronics Data Computer Corporation.

GEM, GEM Draw, GEM Graph, GEM Paint, and GEM Write are trademarks or registered trademarks of Digital Research Inc.

IBM is a registered trademark of International Business Machines.

VT is a trademark of Digital Equipment Corporation.

No reproduction of this document or any portion of its contents is allowed without the specific written permission of Atari Corp., Sunnyvale, CA 94086.

# ATARI

© 1985 Atari Corp.  
All Rights Reserved.



## INTRODUCTION

A few years ago the speed, memory, and graphics power of the ATARI® 520ST™ Computer were beyond the dreams of most computer enthusiasts. Even today, we know of no other computer that can offer you the performance of the 520ST Computer at any price.

The ATARI 520ST System combines advanced technology and graphic sensibility in an easy-to-understand and simple-to-use working environment. No more obscure commands to memorize and no more complicated procedures to follow. Computer operations are represented by icons on the screen—you simply choose what you want, point to the icon, and click!

With over 524,000 bytes of Random Access Memory, the 520ST Computer has the capacity for the most complex word processing tasks or the most detailed spreadsheet procedures. Educational programs take on new potential when they are written to take advantage of the graphics and speed of the ST Computer.

The 520ST Computer offers you all the computing capability you need: 512 different colors, three graphics modes, 80 columns of text, and enhanced graphics resolution. And with the potential to add a hard disk, a modem, a printer, and even a music synthesizer, the ST Computer System can grow with your needs and adapt to new uses.

### How To Use This Manual

We recommend that you read through the manual and learn how your new system works. **It is especially important that you follow the instructions for making a System Backup disk in Chapter 4 before you start working with your 520ST Computer.** Once you have your TOS™ Operating System software on a System Backup disk, you won't have to be concerned about damaging it.

The manual is arranged for easy access to all the information you need. **Chapter 1, *Meet the ATARI ST Computer***, gets you acquainted with your new system. **Chapter 2, *Setting Up the ST System***, shows you how to unpack the system, hook it up, and get it turned on and operating. And **Chapter 3, *Understanding the Keyboard***, presents the unique keyboard on the ST Computer with its calculator keypad and special function controls.

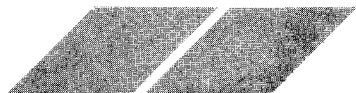



**Chapter 4, *Getting Started***, moves you into control of the system, introducing the GEM™ Desktop, teaching you the tricks of controlling the mouse and drop-down menus, and presenting a step-by-step guide to making a System Backup disk. **Chapter 5, *The Opening Menu***, presents the details of working with each menu item. **Chapter 6, *Managing Disks, Files, and Folders***, demonstrates how to manage your information. **Chapter 7, *Applications for the ST Computer***, provides descriptions of some of the major application programs available for the ST Computer System.

The Appendices to this Owner's Manual are your resources. *Troubleshooting, Mouse Care*, a complete *Glossary*, and technical specifications provide information for every level of user. And should you need more information or wish to become part of the extended network of Atari User Groups, refer to the *Customer Support* section at the very end of this manual.



# TABLE OF CONTENTS

|  |    |
|--|----|
| <b>CHAPTER 1: MEET THE ATARI ST COMPUTER</b> ..... | 1  |
| <b>CHAPTER 2: SETTING UP THE ST SYSTEM</b> .....   | 5  |
| <b>UNPACKING THE SYSTEM</b> .....                  | 5  |
| The Computer .....                                 | 5  |
| The Monitor and Disk Drive .....                   | 5  |
| <b>HOOKING UP THE SYSTEM</b> .....                 | 6  |
| The Computer .....                                 | 7  |
| The Monitor .....                                  | 7  |
| The Disk Drive .....                               | 7  |
| The Mouse .....                                    | 8  |
| Two Disk Drives .....                              | 9  |
| <b>TURNING ON THE SYSTEM</b> .....                 | 10 |
| <b>CHAPTER 3: UNDERSTANDING THE KEYBOARD</b> ..... | 13 |
| <b>CHAPTER 4: GETTING STARTED</b> .....            | 17 |
| <b>THE GEM DESKTOP</b> .....                       | 17 |
| <b>CONTROLLING THE MOUSE</b> .....                 | 18 |
| Pointing .....                                     | 19 |
| Clicking .....                                     | 20 |
| Dragging .....                                     | 21 |
| Multiple Selections .....                          | 21 |
| <b>TAKING A TOUR OF THE GEM DESKTOP</b> .....      | 22 |
| Windows .....                                      | 22 |
| Menus .....  | 28 |
| Files .....  | 28 |
| Desk Accessories .....                             | 30 |
| Trash .....  | 30 |
| Dialog Boxes and Alert Messages .....              | 30 |
| <b>MAKING A SYSTEM BACKUP DISK</b> .....           | 31 |
| <b>CHAPTER 5: THE OPENING MENU</b> .....           | 35 |
| <b>DESK</b> .....                                  | 35 |
| Desktop Info .....                                 | 36 |
| VT52 Emulator .....                                | 36 |
| Control Panel .....                                | 37 |
| Set RS232 Configuration .....                      | 40 |
| Install Printer .....                              | 41 |

|  |    |
|--|----|
| <b>FILE</b> .....  | 41 |
| Open .....   | 42 |
| Show Info .....  | 42 |
| New Folder .....   | 43 |
| Close .....  | 43 |
| Close Window .....   | 44 |
| Format .....   | 44 |
| <b>VIEW</b> .....  | 46 |
| <b>OPTIONS</b> .....                                       | 47 |
| Install Disk Drive .....                                   | 47 |
| Install Application .....                                  | 48 |
| Set Preferences .....                                      | 49 |
| Save Desktop .....   | 49 |
| Print Screen .....   | 49 |
| <b>CHAPTER 6: MANAGING DISKS, FILES, AND FOLDERS</b> ..... | 51 |
| <b>DISKS</b> .....   | 51 |
| Write-Protecting Disks .....                               | 51 |
| <b>FILES</b> .....   | 53 |
| Copying Files .....  | 53 |
| Deleting Files .....                                       | 56 |
| Renaming Files .....                                       | 56 |
| <b>FOLDERS</b> .....                                       | 56 |
| Creating Folders .....                                     | 57 |
| Opening Folders .....                                      | 58 |
| Deleting Folders .....                                     | 59 |
| <b>CHAPTER 7: APPLICATIONS FOR THE ST COMPUTER</b> .....   | 61 |
| <b>APPENDIX A: TROUBLESHOOTING</b> .....                   | 63 |
| <b>APPENDIX B: MOUSE CARE</b> .....                        | 67 |
| <b>APPENDIX C: GLOSSARY</b> .....                          | 69 |
| <b>APPENDIX D: CONNECTOR PINOUT SPECIFICATIONS</b> .....   | 75 |
| <b>APPENDIX E: ATARI 520ST SPECIFICATIONS</b> .....        | 79 |
| <b>CUSTOMER SUPPORT</b> .....                              | 81 |

# CHAPTER 1

## MEET THE ATARI ST COMPUTER

When you use your ST Computer, you are interacting with the entire computer system. Your input goes through the keyboard and the mouse; the computer's output comes through the monitor and disk drive; computation occurs inside the keyboard unit, and information is stored on disks.

The ST Computer is the center of the ST System. Attaching peripheral devices (like disk drives, monitors, and printers) lets your computer perform a variety of functions. Take a look at the outside of your ST Computer to see how the keyboard, the ports, and the switches can work to expand the capabilities of your ST Computer System.

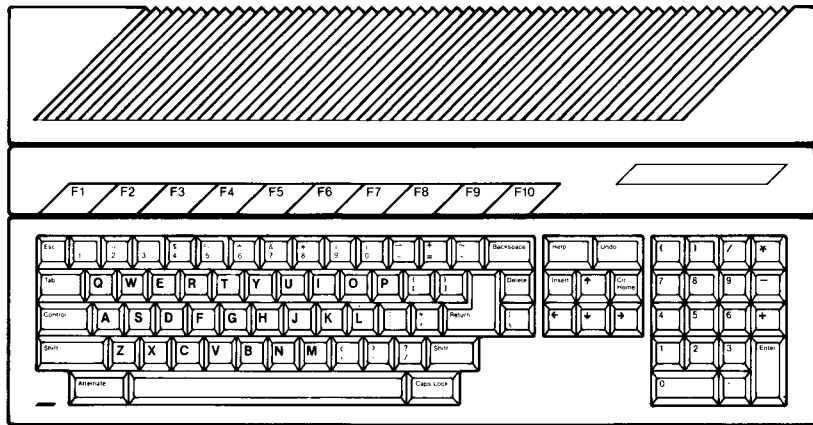

### Keyboard

Full stroke design with access to 94 keys, including a calculator keypad, special function and editing controls.

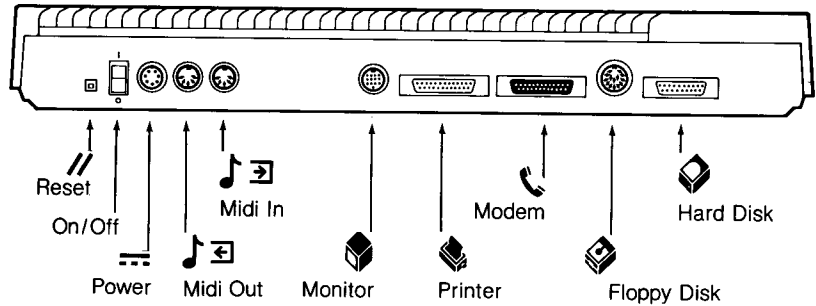

### // Reset

Restarts the ST Computer.

### I O On/Off

Turns the ST Computer on and off.

### ≡ Power

Connects the ST Computer to the power supply.

### ♪ 🎹 Midi Out/Midi In

MIDI stands for Musical Instrument Digital Interface. These ports connect your ST Computer to the latest generation of electronic musical instruments. The Midi In port lets your computer monitor a synthesizer or any MIDI-equipped instrument. The Midi Out port gives the ST Computer control over the digital interface of an electronic instrument, letting you play sophisticated compositions, while changing the volume, tempo, and instrumentation. Using the MIDI interfaces, the ST Computer can become a sophisticated studio recorder that lets you create music one track at a time.

### ◆ Monitor

Your ATARI High-Resolution SM124™ or RGB Analog Color SC1224™ Monitor connects to your ST Computer through this port.

### ◆ Printer

High-speed printers connect to your ST Computer through this parallel interface port. ATARI Printers developed especially for the ST Computer attach here. If you need a more specialized printer, many other types of printers can be attached to your ST Computer.



### **Modem**

Modems are connected to the ST Computer through this port. Any industry-standard RS232C modem can be attached to your computer. Your computer uses a modem to get in touch with other computers using the telephone. Hook your ST Computer up to an information service, to electronic mail, to the computer at your school or office, or to a friend's computer. You can also connect serial printers and other RS232C devices to your computer through the Modem port.

### **Floppy Disk**

Your ATARI MicroFloppy Disk Drive plugs into this port. The ST Computer can work with up to two drives. Each single-sided ATARI SF354™ Disk Drive can store over 360,000 bytes of information.

### **Hard Disk**

An ATARI Hard Disk can be attached to your ST Computer through this port. A hard disk drive can store more information and transmit that information much faster than is possible with a floppy disk drive. The Hard Disk port transfers up to 10 million bits of information per second—enough to fill the entire Random Access Memory (RAM) of the ST Computer in a fraction of a second.

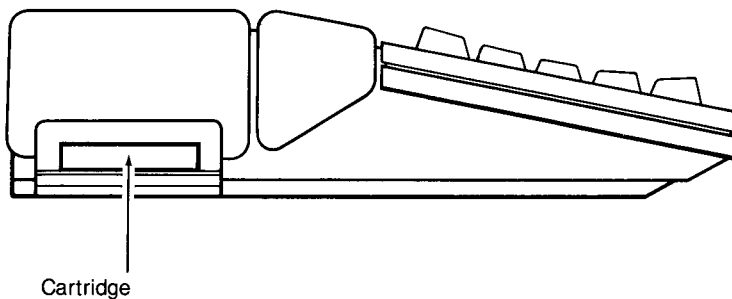

### **Cartridge**

Software programs in cartridge form are inserted into this cartridge slot. Programs on ROM (Read Only Memory) cartridges work instantly without the extra time for loading and without using any of your computer's memory. Up to 131,072 bytes of program information can be contained on a cartridge.

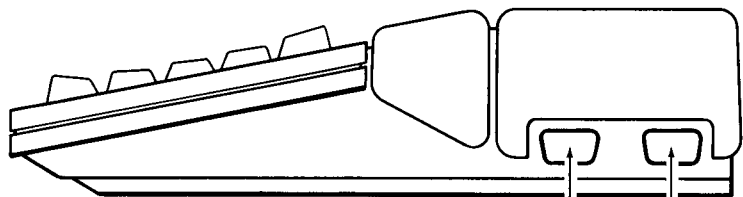

0  
Mouse/Joystick



1  
Joystick

### Mouse & Joystick

The mouse attaches to your ST Computer through Mouse/Joystick port 0. Atari-compatible joysticks can also be attached to your ST Computer through these ports.



## **CHAPTER 2**

# **SETTING UP THE ST SYSTEM**

## **UNPACKING THE SYSTEM**

The ATARI ST Computer is part of a complete computing system: the computer, the monitor, and the disk drive. You must have all three components to operate the system. When you open the large ST System carton, there are three individual boxes inside, each containing one of the three parts of the system. Remove the three boxes carefully and follow the unpacking instructions below. It is a good idea to save the packing materials for storing and transporting your computer system.

### **The Computer**

When you unpack the box marked "ST Computer", you will find the following items:

- ATARI ST Computer
- Power Supply
- Mouse
- ST Language Disk
- TOS System Disk
- Owner's Manual
- Warranty Card

If you are missing any of these items, contact your ATARI Computer retailer.

### **The Monitor and Disk Drive**

Inside the ATARI Monitor and Disk Drive boxes are manuals for each component. The manuals describe the unpacking procedures and the specific characteristics of each component. Technical specifications, troubleshooting guides, care and safety charts, and Atari Customer Service information are also provided in the manuals.



Spend a few moments to read over the manuals, then unpack the monitor and disk drive carefully. Check to make sure that the listed parts of each package are there. You will notice that each box contains the following components:

- Monitor or Disk Drive
- Power Cable
- Interface Cable
- Manual
- Warranty Card

Until you have your system completely set up, it is a good idea to keep the pieces for each component separate to avoid any possible confusion in the set-up procedure.

## **HOOKING UP THE SYSTEM**

Setting up your ST Computer System is easy. All the devices simply plug together. All you need to do is plug the connectors into the right places.

It is important that you choose the proper location for your ST System. Set up your system where it won't have to be moved often and is not subject to intense heat or moisture. Your ST System is made up of sophisticated pieces of electronic equipment. Anywhere you would set up your stereo system or your television is suitable for your computer.

A good plan for arranging your system for comfortable use is to first decide how you want your components arranged, then go through the process of attaching the pieces to each other, and then to the power supply.

Arrange the computer, monitor, and disk drive to your satisfaction on a firm level surface, then follow the instructions below. Refer to the Owner's Manuals that came with your ATARI Monitor and Disk Drive for more ideas and information on setting up and caring for your system.

## The Computer

1. With the On/Off Switch in the Off position, insert one end of the Power Adapter into the port marked "Power" on the back of the ST Computer. Plug the other end into the wall outlet or a power strip.

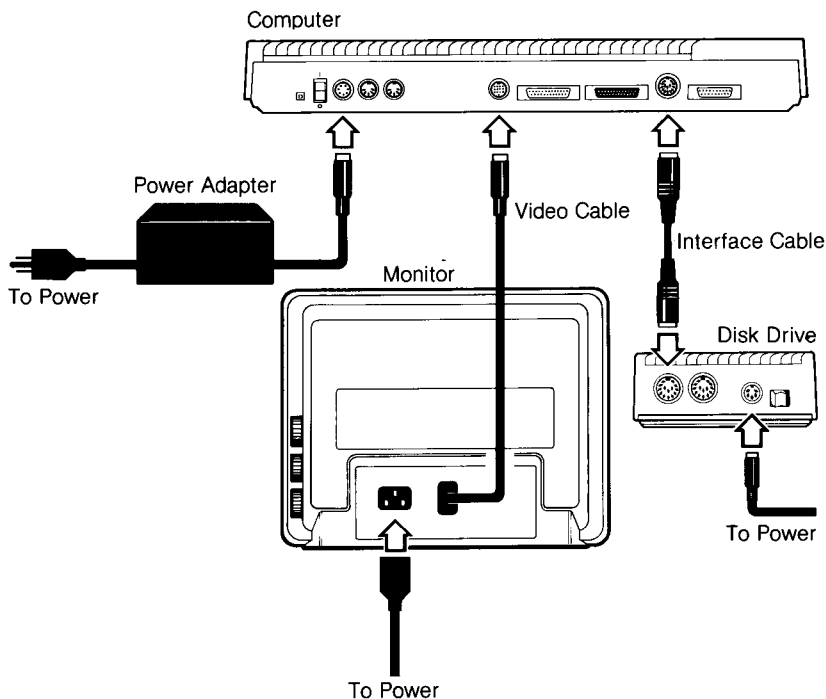

## The Monitor

2. Insert the video cable (attached to your monitor) into the port marked "Monitor" on the back of the ST Computer.
3. With the monitor turned off, insert the monitor's power cable into a wall outlet or power strip.

## The Disk Drive

4. Insert one end of the round interface cable (supplied with your disk drive) into the I/O Connector marked "In" on the back of the disk drive. Plug the other end into the port marked "Floppy Disk" on the back of the ST Computer.

5. With the disk drive Power switch in the "Off" position, plug one end of the power adapter into the port marked "Power" on the back of the disk drive. Plug the other end of the power adapter into a wall outlet or power strip.

**Warning:** When setting up your computer system, place your disk drive at least 12 inches from your monitor. Monitors emit a magnetic field that can damage information stored on disks.

## The Mouse

6. Insert the end of the mouse cable into Mouse/Joystick port 0 on the side panel of the ST Computer. Be sure to insert the plug correctly. The plug is larger at the top and will fit into the socket in only one way. Once inserted, the mouse can be moved around while still attached to the computer.

**Note:** For more information on your mouse, refer to **Appendix B, Mouse Care.**

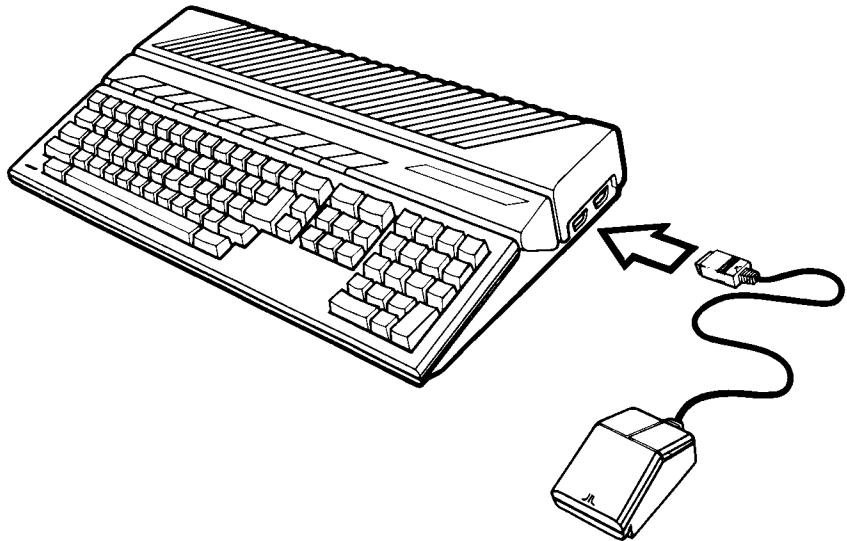

## Two Disk Drives

Your ST System can control up to two floppy disk drives. Hooking up the second drive is called *Daisy Chaining* the drives together. If you've purchased a second drive, follow the steps below to attach the drive to your ST System.

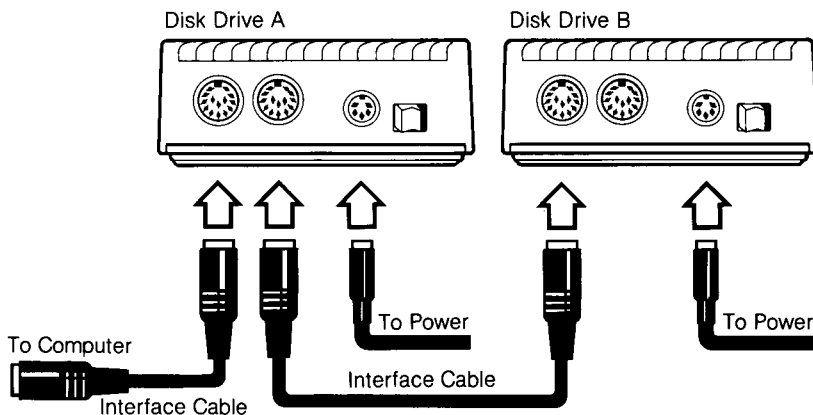

1. Insert one end of the interface cable of Drive B (the second drive) into the I/O Connector marked "In" on the back of the disk drive. Insert the other end of the cable into the I/O Connector marked "Out" on the back of Drive A.
2. With the Drive B Power switch in the "Off" position, plug one end of the power adapter into the port marked "Power" on the back of the disk drive. Plug the other end of the adapter into the wall outlet or a power strip.

## TURNING ON THE SYSTEM

1. Check to make sure that all your cable and power connections are inserted properly.
2. Turn on your monitor, your disk drive, and then your computer. Your monitor screen will look like this:

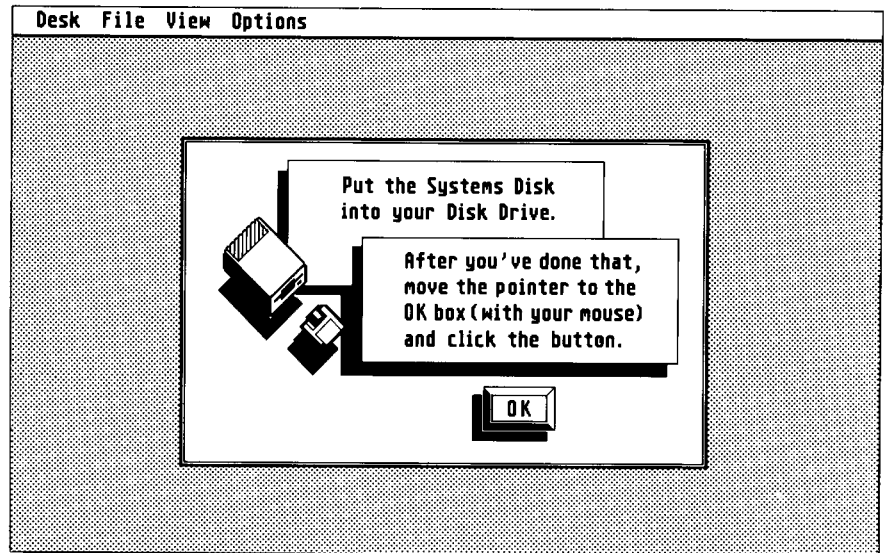

3. Follow the prompts on the screen. Hold the TOS System Disk by its plastic casing with the label facing up and the metal end towards the slot on the disk drive. Slide the disk gently forward into the drive opening until it "clicks" into position. The disk will be completely inside the drive when properly inserted.

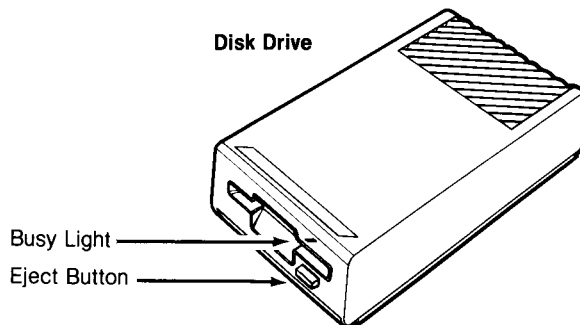





**Note:** If the disk doesn't slide into the drive smoothly, pull it out, and reinsert it. Never force the disk into the drive. To remove a disk from the drive, push the Eject button on the front panel of the drive. Never try to remove a disk when the Busy light is on as information stored on the disk might be damaged.

4. Move the mouse until the mouse pointer  is on the OK button and click the left mouse button once.

Or you can press the **[Return]** key on the ST Computer keyboard.

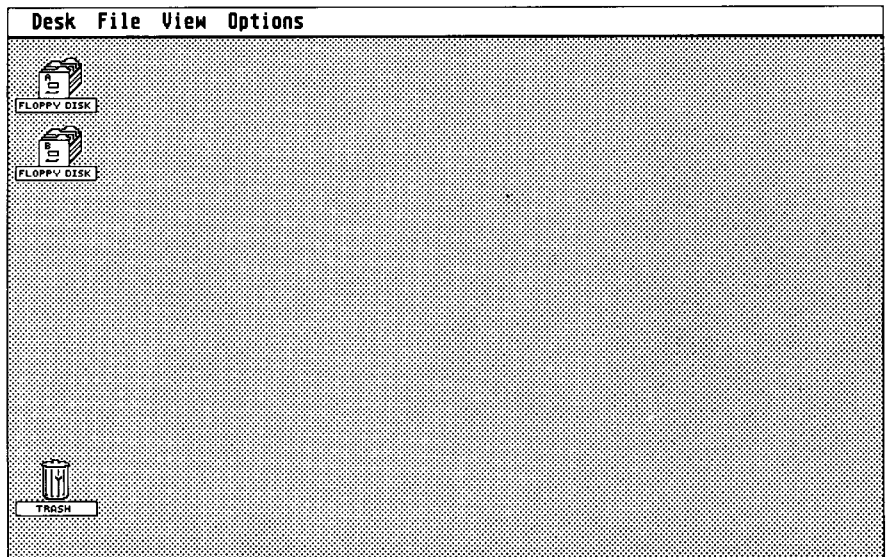
The Busy light on the front panel of the drive will light up as the information on the disk is loaded into your computer. The GEM Desktop will then appear on the monitor screen.





The GEM Desktop is the starting place for learning about your ST Computer System. Before you begin experimenting with your computer, look over this Owner's Manual. Understanding fully how to operate and care for your system will make the learning process easier and more fun. **It is especially important that you follow the directions on *Making a System Backup Disk* in Chapter 4.**

**Note:** If the GEM Desktop is not on your monitor screen, check to make sure that you have followed the steps above or refer to **Appendix A, *Troubleshooting***.

### **Caring For Your ATARI ST System**

- Wipe off components with a moist, lint-free cloth.
- Keep all parts of the system out of direct sunlight and away from intense heat.
- Never use household solvents or cleaners on the computer or components.
- Keep liquids away from work area.
- Avoid smoking near your computer system.
- Don't move the computer more than is necessary.
- Avoid dusty or greasy work areas.

## CHAPTER 3 UNDERSTANDING THE KEYBOARD

The ST Computer keyboard looks very similar to those familiar office tools—the typewriter and the calculator. But the 94 keys on the computer keyboard offer advanced calculating and editing opportunities. The special function keys are designed to streamline many procedures used in software programs.

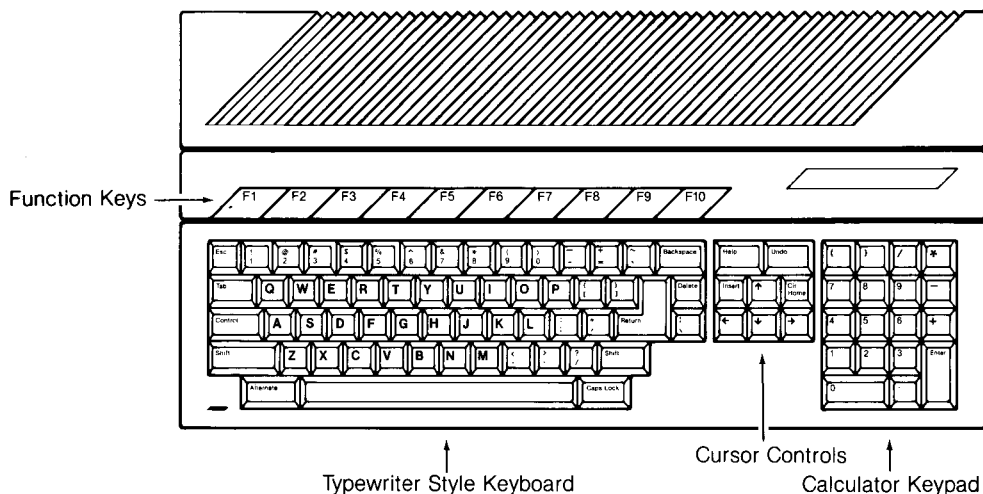

The following descriptions illustrate the groups of keys that make up the ST Computer keyboard and explain how the keys function.

The letters of the alphabet on the ST Computer are arranged exactly the same as on a typewriter. Press a key to create a lowercase letter. If the **[Shift]** key is held down, uppercase letters result. Pressing the **[Return]** key moves the cursor to the beginning of the next line.

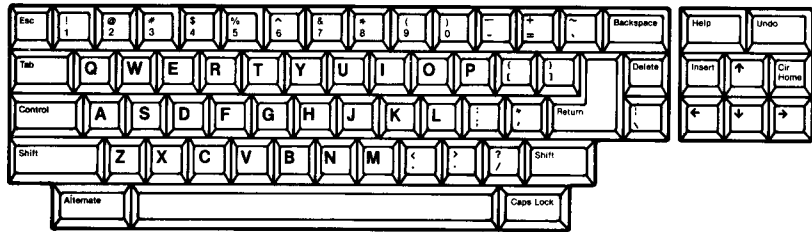

The number and symbol keys have two different characters on the key tops. Pressing either a number or symbol key produces the lower character on the key. When [Shift] is pressed, the upper character appears.

Press the [Caps Lock] key to produce uppercase letters without the [Shift] key. Press [Caps Lock] again to return to lowercase. The [Caps Lock] key only effects the letters of the alphabet; numbers and symbols are not shifted when [Caps Lock] is on.

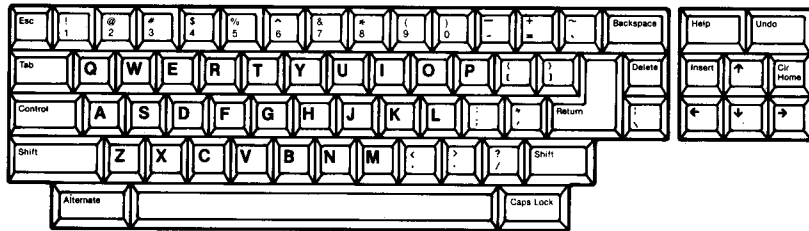

The cursor controls move the cursor around a window in a text-editing application like word processing. Many software programs use these keys in the following ways. The [Delete] and [Backspace] keys erase the last character preceding the cursor and pull all subsequent characters into the vacated position. The [Insert] key creates an extra space and pushes back the remaining characters on the line. The [Cir Home] key brings the cursor to the top of a text screen. And the [Tab] key moves the cursor to the next tab position.

With the **[Alternate]** key pressed, the four arrow keys control the mouse pointer on the GEM Desktop instead of the text cursor. Each press of the cursor key moves the pointer 8 pixels. If **[Shift]** and **[Alternate]** are both held down together, the mouse pointer moves one pixel with each press of the cursor key. The **[Insert]** and **[Alternate]** keys function as the left mouse button when pressed together. The **[Clr Home]** and **[Alternate]** keys function as the right mouse button when pressed together. For more information on using cursor controls rather than the mouse to activate the ST Computer windows, see **Chapter 4, Getting Started**.

The **[Esc]** key updates the top or active window on the GEM Desktop. If you have a disk window opened and then insert a new disk into the drive, pressing **[Esc]** changes the window display to show the files on the new disk.

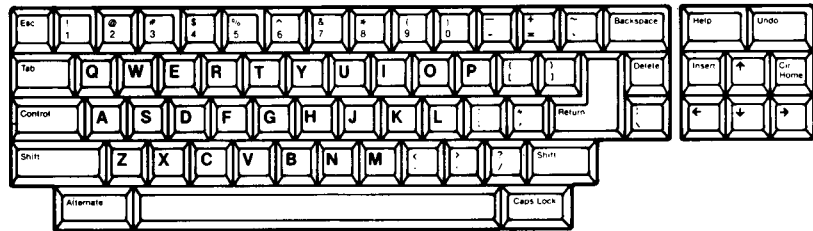

The calculator keypad holds the numbers, arithmetic symbols, and **[Enter]** key. They are arranged in standard calculator fashion for convenience and speed in number-oriented work. The **[Shift]** key has no effect on these keys. **[Enter]** performs the same functions as the **[Return]** key when you use the calculator keypad.

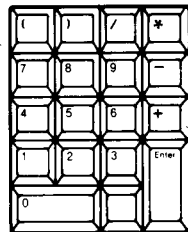

The function keys are used in software programs to perform specialized procedures. The **[Control]** key, like the **[Shift]** and **[Alternate]** keys, is held down to change the meaning of a character. Refer to the manual for each software program to learn what these keys do.

If you have a graphics printer attached to your ST Computer, you can print whatever is on your screen by pressing the **[Alternate]** and **[Help]** keys together. (Pressing the **[Alternate]** and **[Help]** keys again will stop the printing process.) This function is the same as using the Print Screen option of the Options menu. (See the section on Options in **Chapter 5, The Opening Menu.**)

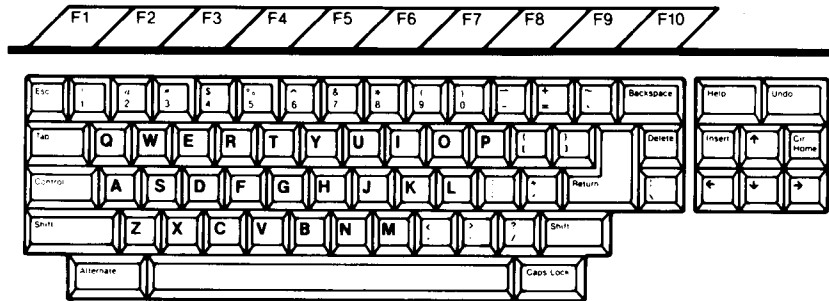

# CHAPTER 4 GETTING STARTED

## THE GEM DESKTOP

When you first turn on the ST Computer and load the TOS System disk, you'll see the GEM Desktop with three "icons" (pictures) along the left side of the screen and the opening Menu Bar along the top. The Floppy Disk icons allow you to control the information on your disks. The Trash icon lets you dispose of your unwanted information. And the Menu Bar gives you access to most of the utilities and applications available from the GEM Desktop.

As you get acquainted with your ST System, the GEM Desktop and its features will be an important point of reference for you.

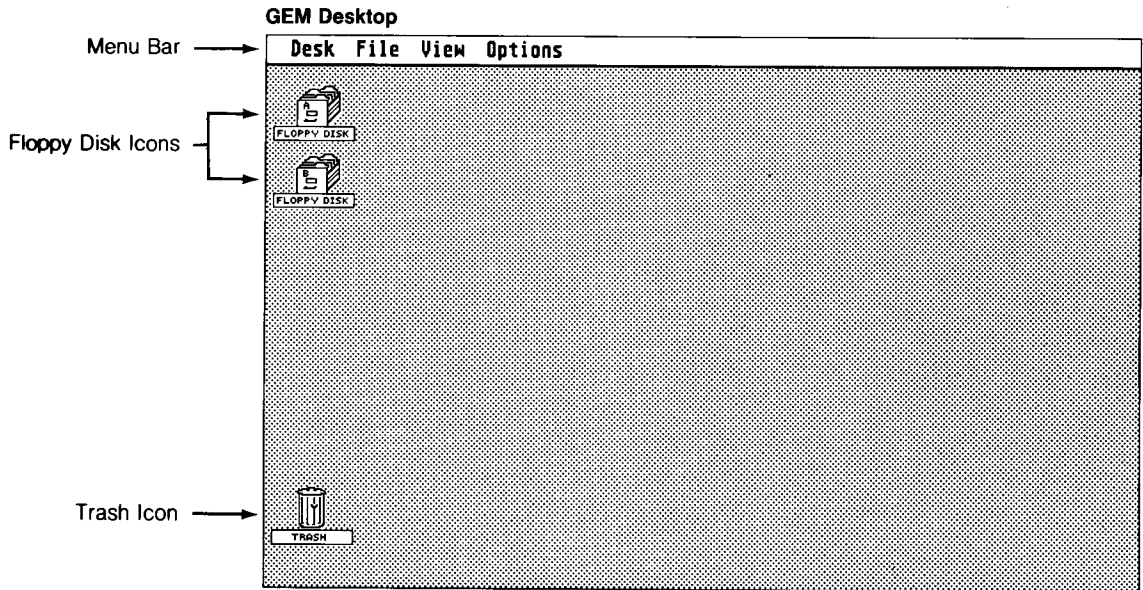

The mouse is the main device for controlling your ST Computer. But you have the option of using either the mouse or the cursor keys to manipulate the menus. If you prefer using the cursor keys, refer to "Controlling the Mouse Pointer With the Cursor Keys" on page 19 for details.

# CONTROLLING THE MOUSE

The mouse is a small box with two buttons on top and a small ball underneath. It detects motion (direction, distance, and speed) through the movement of the small ball. The left mouse button is used to “select” and move icons and files. The right button is used with some software programs.

To understand how the mouse operates, place it on a flat surface so that the side with the cable is facing the computer. Then move the mouse around—left, right, forward, backward, in circles. On the monitor screen a small arrow called the “mouse pointer” follows the movements of the mouse.

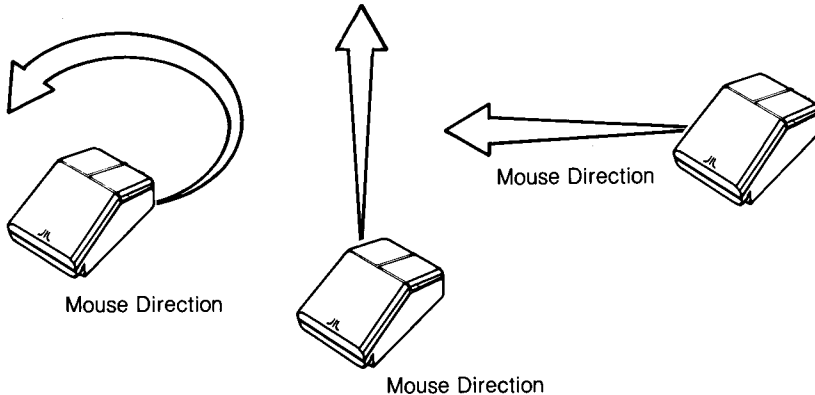
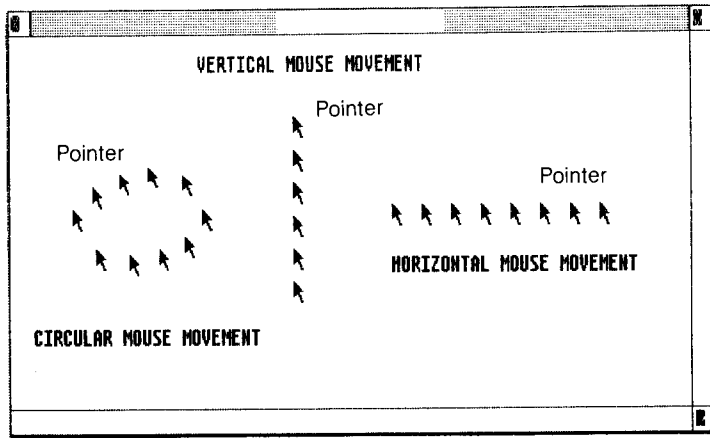



By moving the mouse across a surface, you can position the mouse pointer anywhere on the GEM Desktop. With the GEM Desktop on the monitor screen, practice moving the pointer around the Desktop.

### Controlling the Mouse Pointer With the Cursor Keys

Press the [Alternate] key and any of the cursor keys to move the pointer 8 pixels.

Press the [Alternate], [Shift], and a cursor key to move the pointer 1 pixel.

Press the [Alternate] and [Insert] keys to select an icon. This is the same as pressing the left mouse button.

Press the [Alternate] and [Clr Home] keys to perform the right mouse button functions.

Press the [Alternate], [Insert], and a cursor key together to "drag" an icon.

To adjust the speed and responsiveness of the cursor keys, refer to the section on the Control Panel in **Chapter 5, *The Opening Menu***.

### Pointing

The mouse pointer selects icons on the screen. When you point to a word or an icon, the tip of the mouse pointer must be touching that word or icon.

#### Positioning the Mouse Pointer

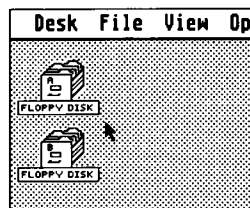

Incorrect

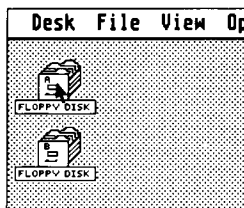

Correct

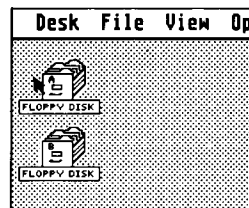

Incorrect

## Clicking

When you "select" an icon, you tell the computer that you want to do something with the program or file that the icon represents. You select an icon by pointing at and "clicking" on the picture. To click on an icon, press, and immediately release the left mouse button.

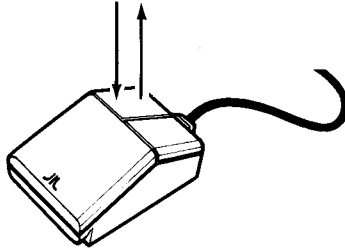

Try pointing at and clicking on one of the icons. When you click on an icon, it darkens to indicate that it is selected. To cancel your selection, move the pointer anywhere else on the GEM Desktop and click the left mouse button. If you select a second icon, the first selection will be cancelled. (See "Multiple Selections" for techniques on selecting more than one icon.)

**Selecting an Icon**

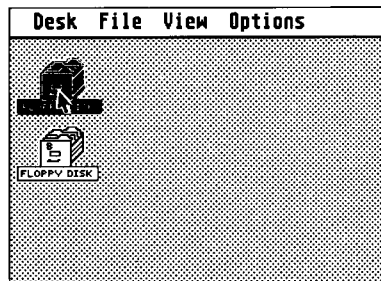

**Cancelling a Selection**

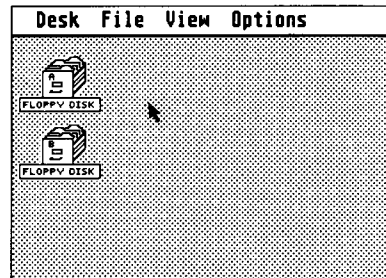

**Note:** To customize the clicking rate and responsiveness of the mouse button, refer to the section on the Control Panel in Chapter 5, *The Opening Menu*.

## Dragging

You can rearrange the icons on the GEM Desktop in any way you like. To move an icon, select it (click on the left mouse button), and "drag" it to its new location. To drag an icon, press and hold the left mouse button while you move the mouse pointer. A "ghost" (outline) of the icon follows the pointer. When you release the button, the icon jumps to its new location.

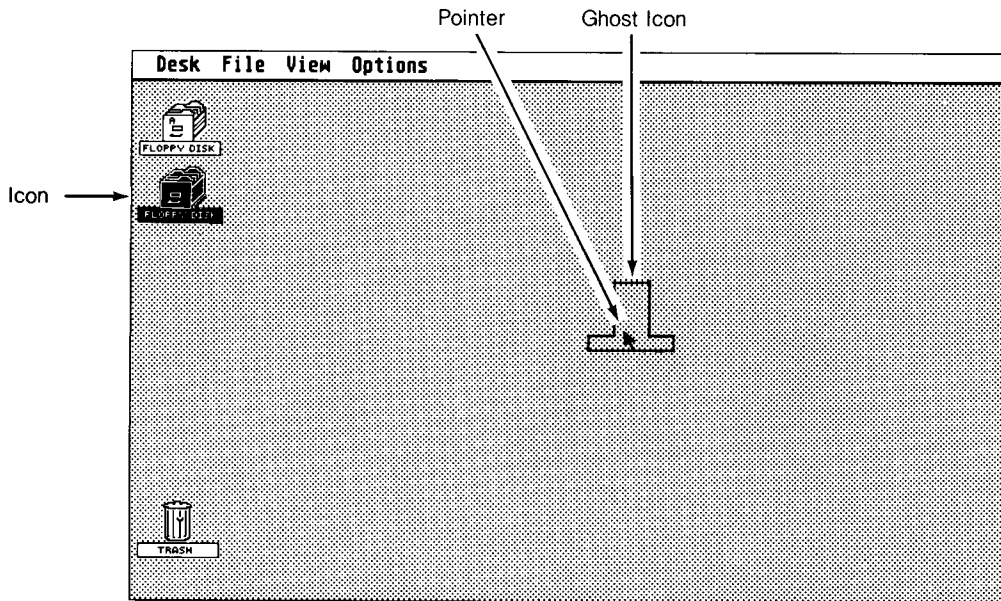

## Multiple Selections

You may want to select more than one icon. However, once you have clicked on an icon, clicking anywhere else on the screen will cancel your first selection.

There are two methods to select more than one icon. The first method is to press and hold the left mouse button while the mouse pointer is nearby (but not touching) the icons you want to select. Then drag the pointer across the desired icons. As you drag the pointer, a small box will form around the icons, and every icon inside that box will be selected after you release the left mouse button.

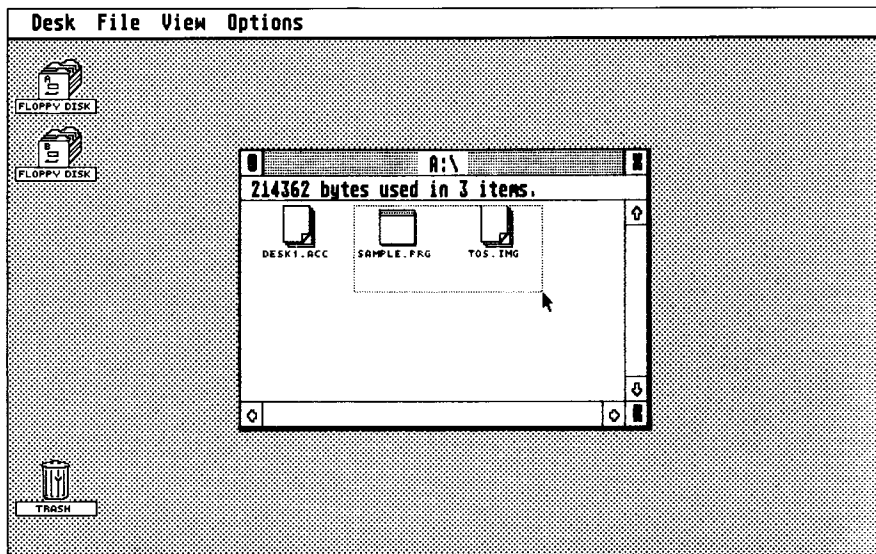

The second method for selecting more than one icon is to hold down the [Shift] key on the keyboard while you click on the icons. This is a convenient method when the icons are not in sequence and cannot be separated from each other within a large box.

Remember, if you want to cancel your selection, move the mouse pointer anywhere else on the GEM Desktop and click the left mouse button once.

## TAKING A TOUR OF THE GEM DESKTOP

### Windows

On most computers, all the activity takes place on the full video display screen. On the ST Computer, the activity takes place in areas called "windows." Windows are miniature screens within the larger video display screen. The GEM Desktop allows you to have up to four open windows at the same time.

**Note:** The open windows in this manual are examples only. Your TOS System disk may show a different number of bytes used and different files.

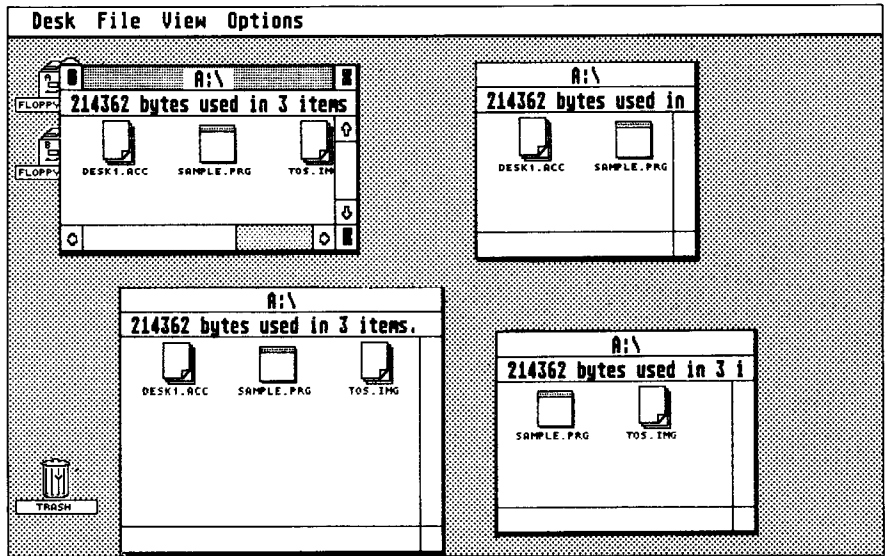

## Opening Windows

There are two methods to open a window. The first method is "double-clicking". Point to the icon for Floppy Disk A and double-click the left mouse button (quickly click the button twice).

The second method to open a window is using the Open option under the File heading in the Menu Bar. Follow these steps to open a window with the File option:

- Point at the Floppy Disk A icon and select it.
- Point at the File heading on the Menu Bar
- Move the pointer until the word "Open" is shaded, then click the left mouse button once.

As the computer is opening Floppy Disk A, the Bee icon appears. Whenever the computer retrieves information from the disk drive, this icon will be displayed.

When Floppy Disk A opens, you'll see several file icons and the utilities available in every window format.

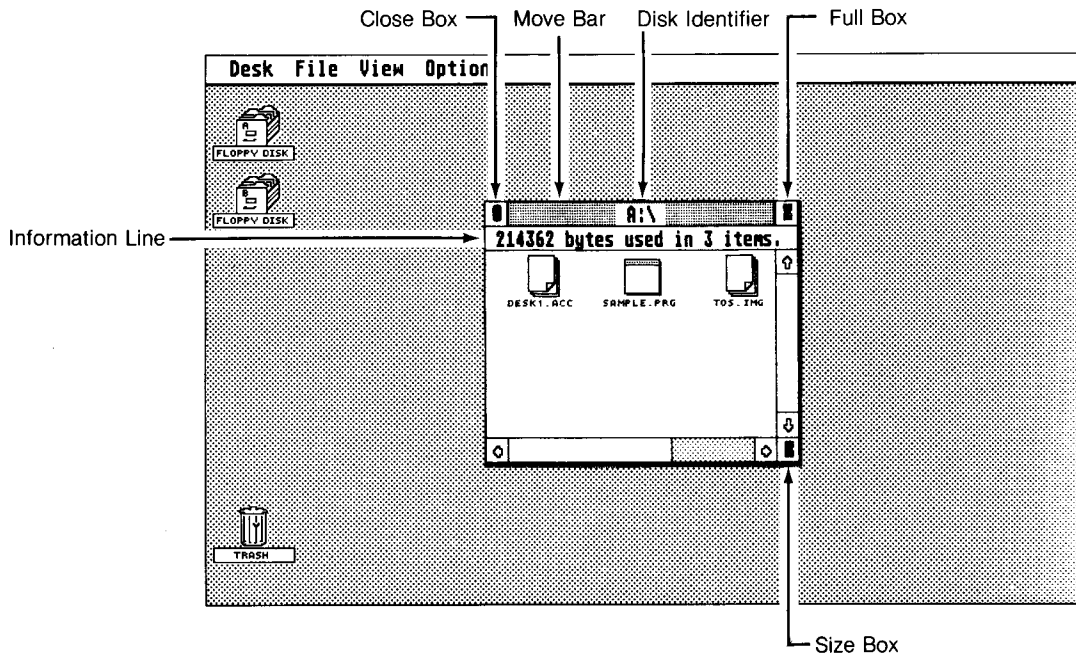

The Disk Identifier and Information Line are window management tools. The Disk Identifier keeps track of which disk you're using (either A or B). The Information Line tells how much of the disk's storage capacity is filled, and with how many items. Your SF354 Disk Drive has a total storage capacity of 357,376 bytes. To see the remaining storage capacity of a disk, refer to the Show Info option under the File heading on the Menu Bar.

A window is active when the Move Bar (along the top edge) is shaded and the Scroll Bars (along the right and bottom edges) contain the Scroll Arrows and utility boxes. An active window can be sized, moved, dragged, or have its contents scrolled. Only one window can be active at a time. If you have more than one window open, you can make any open window active by pointing and clicking on it.

## Moving Windows

You can move a window to any position on the GEM Desktop by using the Move Bar. The Move Bar is located on the top edge of a window. To move a window, point at the Move Bar, press and hold the left mouse button, then drag the window to any location on the GEM Desktop and release the button.

Moving windows is especially useful when you need to position more than one open window on the Desktop and need to move files or folders from one window to another.

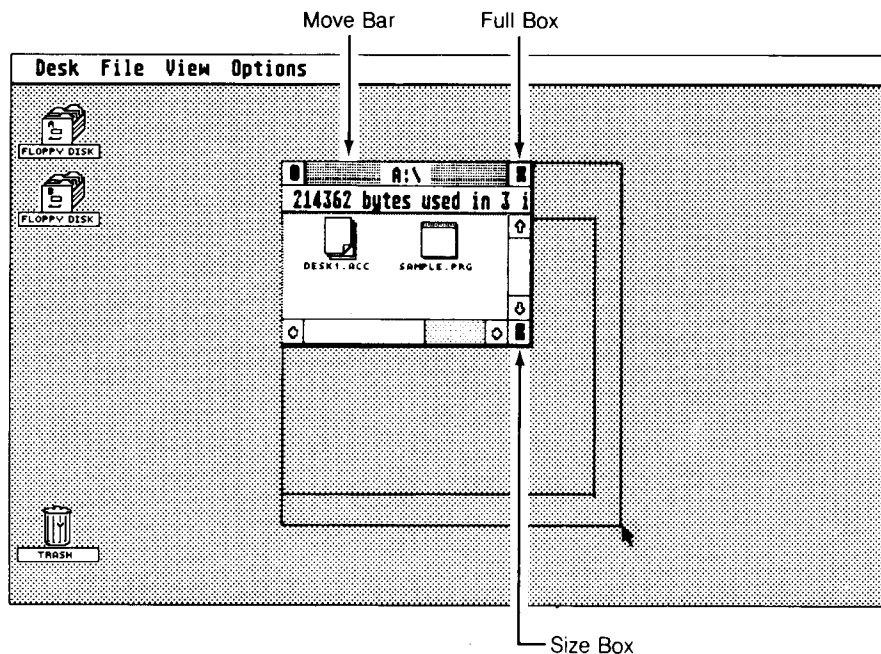

## Sizing Windows

You can make a window any rectangular size or shape you want. First point at the small box called the Size Box in the lower right-hand corner of the window, then press and hold the left mouse button. Then drag the Size Box in the desired direction—down, to lengthen the window; up, to shorten; right, to widen it; left, to make it narrower.

A quick way to enlarge a window is to point and click on the small box called the Full Box in the upper right-hand corner of the window. If you click on this box, the window will expand to fill the entire screen. Clicking on the Full Box again returns the window to its previous size, shape, and position on the GEM Desktop.

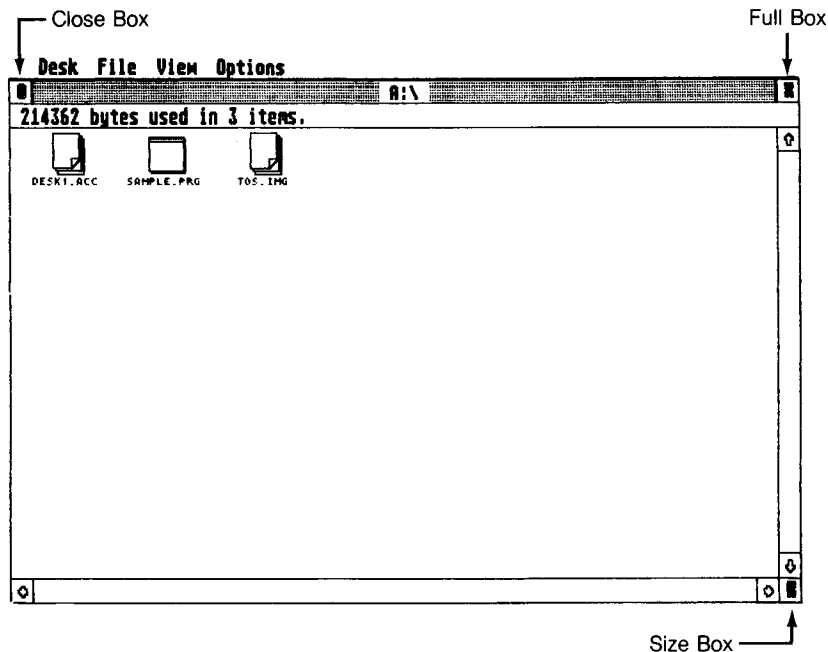

### Scrolling Windows

If you want to see the items that may be cut off at the edges of a window, but you don't have enough room to make that window larger, you can "scroll" the contents of the window. The two Scroll Bars—one along the right side and the other along the bottom edge of the window—will scroll the contents to the right, to the left, up, or down.

Each Scroll Bar has an arrow at both ends. To scroll, point at the Scroll Arrow that indicates the direction in which you want the contents to move, then click the left mouse button.



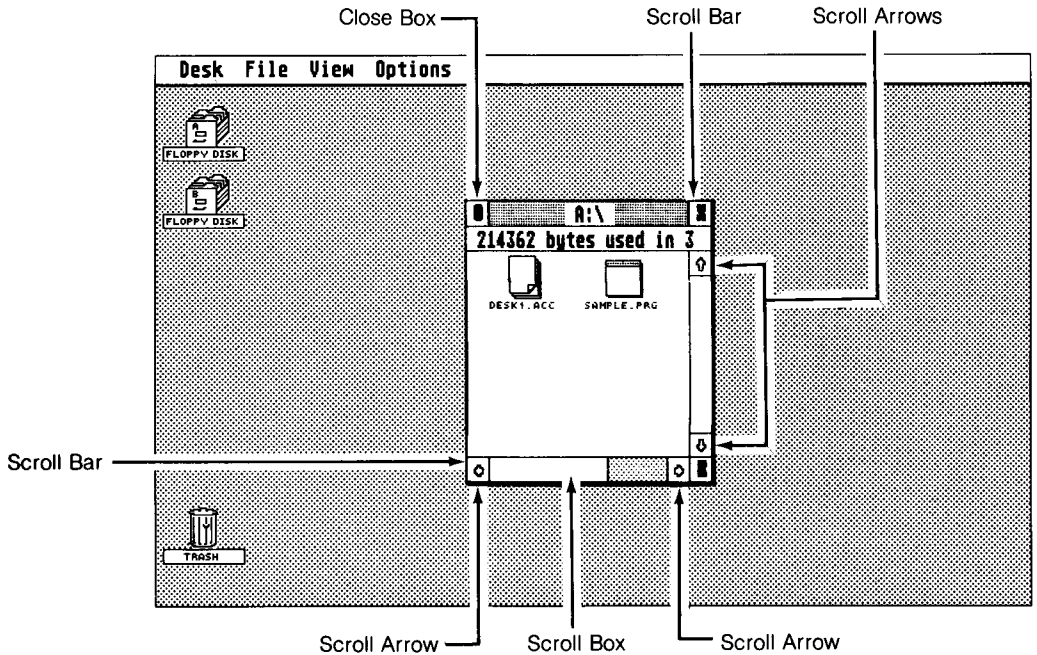

Each Scroll Bar contains a small box called the Scroll Box. Another way to scroll is to drag the Scroll Box in the vertical Scroll Bar up or down, or to drag the Scroll Box in the horizontal Scroll Bar left or right.

A portion of the Scroll Bar will be shaded when there are files hidden that you might not otherwise notice or remember.

### **Closing Windows**

To close a window, click on the small box called the Close Box in the upper left-hand corner of the window. The window will immediately close and return you to another window or to the GEM Desktop.

## Menus

Along the top of the GEM Desktop is the Menu Bar. The menu headings are: Desk, File, View, and Options. To see the options within any menu, point at the menu heading. The word will become shaded and the menu will automatically drop down.

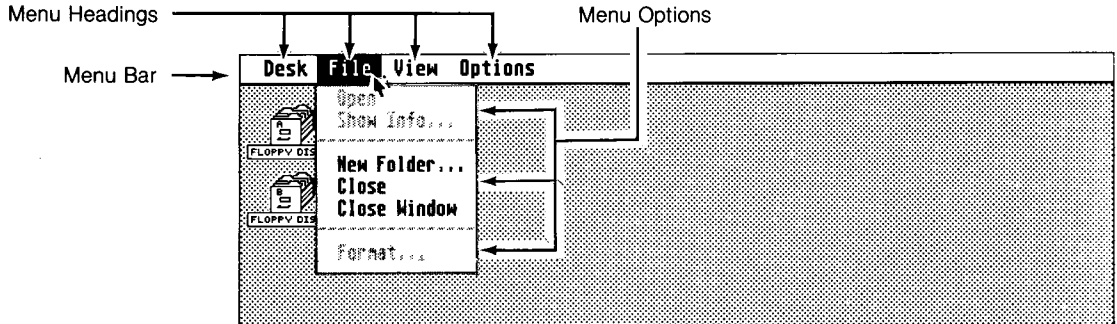

When you are ready to select a Menu option, point at the item you want and click the left mouse button once. The lightened words are options not available to you. These options require that a file, an application, or a device already be opened. Look over **Chapter 5, *The Opening Menu***, for detailed information on how to choose a Menu option and how to follow the GEM Desktop prompts. Some of the options may appear to cause unexpected results if you are not familiar with their functions.

## Files

Your information is stored in files. To see the files on the TOS System disk, double-click on the Floppy Disk A icon to open the window. Then examine the icons inside the window.

**Note:** The open windows in this manual are examples only. Your TOS System disk may show a different number of bytes used and different files.

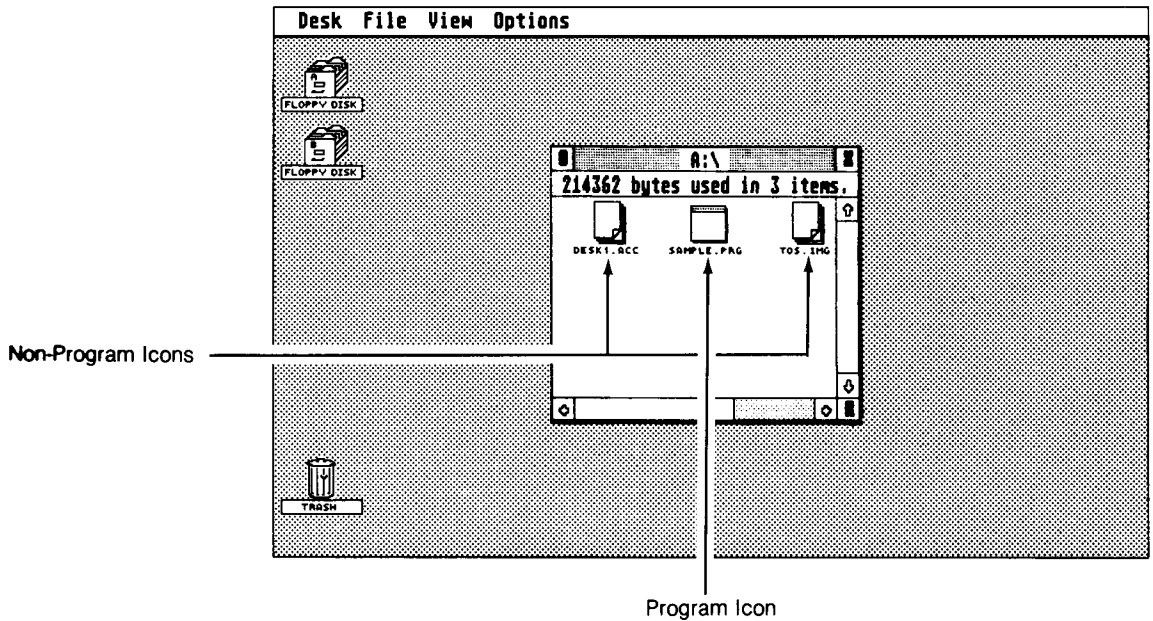

The icons that look like sheets of paper with a corner folded over represent non-program files. These files contain data that are used by application programs.

The icon without the folded corner is a program file. Program files contain application programs. Double click on the file "SAMPLE.PRG". The icon will zoom open into a window, and the application will start automatically. This demonstration program lets you practice your window sizing, moving, and closing skills. To exit from the sample program, close the application window.

A third type of icon looks like a file folder. Folders may contain several files. If you double-click on a folder, it will open out into a window that shows additional icons representing various files. Refer to the section on Folders in **Chapter 6, Managing Disks, Files, and Folders.**

## Desk Accessories

Desk accessories can be activated at any time, whether you are using the GEM Desktop or most any other application. The standard desk accessories that come with the ST Computer System are the VT52 Emulator, Control Panel, Set RS232 Config., and Install Printer package.

Point at the Desk heading, then click on the option you wish to use. For more information, refer to the Desk section in **Chapter 5, The Opening Menu.**

### Trash



**TRASH**

The Trash Icon

The Trash icon works a lot like a real trash can. If there is something you want to remove from your disk, drag the item to the Trash icon. It will be erased from your disk.

**Warning:** The Trash icon works more like an incinerator than a trash can. Once you have thrown something away, it's gone. You can't reach back in and pull it out again.

## Dialog Boxes and Alert Messages

### Dialog Boxes

When the ST Computer needs to exchange information with you, it will show a Dialog Box in the center of the GEM Desktop. Dialog Boxes establish a dialog between yourself and the computer. The Dialog Box below is requesting information from you so a procedure can be completed.

#### Dialog Box

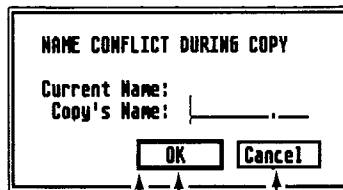

Enlarged Border

Exit Buttons

To exit from a Dialog Box, point at one of the Exit buttons and click. If the Exit button has an enlarged border, you can press the [Return] key on the ST Computer keyboard rather than using the left mouse button.

### **Alert Messages**

Alert Messages are displayed in a Dialog Box. They inform you that the operation you are performing or about to perform is improper or impossible.

When you see an Alert Message, like the one below, just follow the prompts.

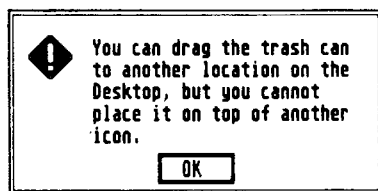

## **MAKING A SYSTEM BACKUP DISK**

Every ST Computer owner should make a System Backup disk. If something happens to the TOS System disk that came with your system, you will be unable to work with your computer. Also, the TOS System disk is permanently write-protected. You cannot put any new information on the disk. If you decide to customize certain responses of your computer with the Control Panel, you will not be able to save your custom changes. Once you make a System Backup disk you can save your changes and not worry about damaging your original TOS System disk.

To make a System Backup disk you will need a new, blank, 3-1/2 inch disk. (Disks can be purchased at any computer retailer.) Making a System Backup disk is very easy. With the computer turned on and the TOS System disk loaded, just follow the steps below and read the prompts that appear in the Dialog Boxes.

1. If you have one disk drive, insert the blank Backup disk into the disk drive and place the TOS System disk aside. When the ST Computer requires a disk switch, it will display the message in a Dialog Box.

**Note:** If you have two disk drives, insert the TOS System disk into Drive A and the Backup disk into Drive B. With two drives, always keep the TOS System disk in Drive A and the Backup disk in Drive B, and follow the prompts.

2. To format the Backup disk, click on the icon for Floppy Disk B and select the Format option from the File heading on the Menu Bar. Click on the left mouse button and the first Format Box, shown below, is displayed.

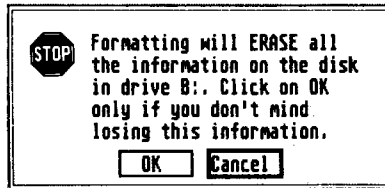

This message warns you that formatting will erase the disk. This is a safeguard to prevent you from accidentally formatting and erasing the disk. Click on the OK button and proceed to the second Format Box.

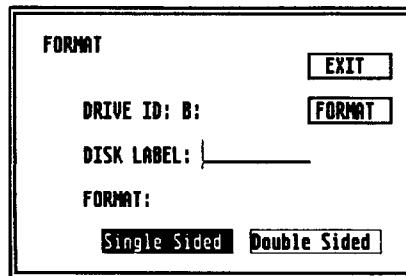

You can name your disk in this Dialog Box. Type in a descriptive name, like "System.1". Make sure the option "single-sided" is shaded, then click on the Format button. You already have your Backup disk in Drive A, so continue on to the next step.

As the disk is formatted, you can watch the process with the Working Box.

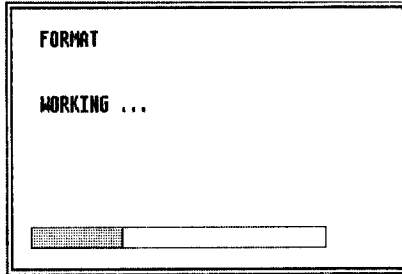

The System Backup disk is now formatted and can now hold 357,376 bytes of information. Click on the Exit button.

You will be returned to the Format Box. Click on the Exit button and return to the GEM Desktop.

**Note:** If the formatted disk cannot hold 357,376 bytes of information, it is a defective disk. Place a new disk in the disk drive and format it.

3. To copy the TOS System disk, insert it into the disk drive, select Floppy Disk A with the mouse pointer and drag it on top of the Floppy Disk B icon and release the left mouse button.

You will see a Dialog Box warning you that copying Disk A to Disk B erases information on Disk B. Click on the OK button and the Diskcopy Box is displayed.

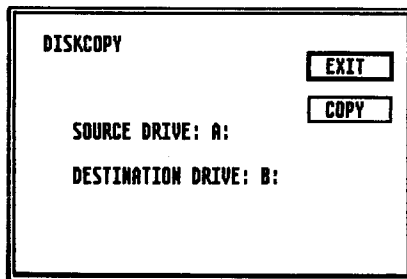



Click on the Copy button and follow the prompts to finish the copying process. You will be instructed to switch disks until the copying process is completed.

When the disk has been copied, you will see the Diskcopy Box again. Click on the Exit button and return to the GEM Desktop. Put the TOS System disk in a safe storage place. Label the Backup disk "Backup System disk". From now on, use the Backup System disk whenever you work with your ST Computer.



## CHAPTER 5 THE OPENING MENU

The Opening Menu is the starting point for most of your work with the ST Computer. When you first turn on the ST Computer after loading the TOS System disk, the Menu Bar is located at the top of the GEM Desktop. The Menu Bar has four headings: Desk, File, View, and Options. Each heading has its own menu. To access a menu from the Menu Bar, point at a heading and the menu will drop down.

### DESK

The Desk Menu contains items that you can access at most times, whether you are working from the GEM Desktop or from within most any program.

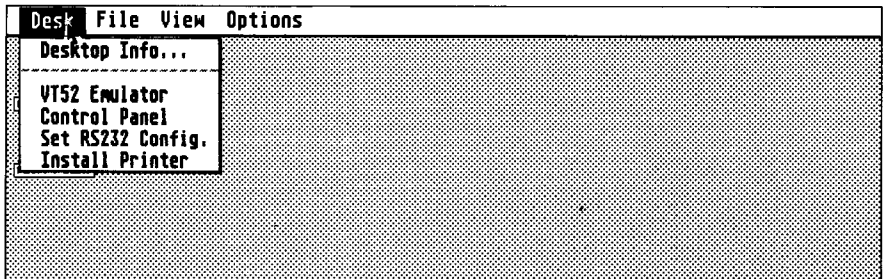

## Desktop Info

The Desktop Info option is the billboard for the GEM Desktop, showing which program is loaded into the system and the copyright information. Most programs will display similar types of identifying information in this option. Select the Desk Info option and the following Dialog Box will be displayed:

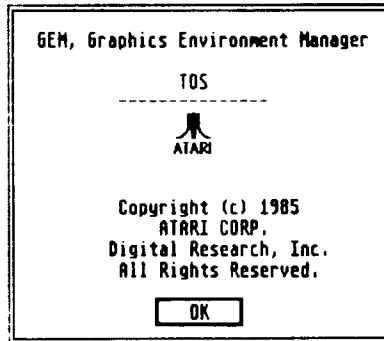

## VT52 Emulator

The VT52 Emulator is a telecommunications program, allowing you to send and receive information through the Modem port located on the back panel of the ST Computer. The program is used most often when the computer is attached to a modem and to a communications network through the telephone lines.

Select the VT52 Emulator option from the Desk heading. The following instructions will be displayed:

```
*****
* Atari VT52 Terminal Emulator *
* (c) Atari Corp.                *
*****
Press: 1) UNDO to return to desktop.
       2) HELP to configure terminal.
```



You have three options for using this program:

1. Use the VT52 Emulator to communicate with another computer system. To use the emulator, simply type your message. It will go through the Modem port to the modem, over the telephone lines, and into another system.
2. Press the **[Help]** key on the ST Computer keyboard and the RS232 Configuration menu will appear. For detailed information on how to use the menu, refer to the section, "Set RS232 Configuration".
3. Press the **[Undo]** key on the ST Computer keyboard and return to the GEM Desktop.

## **Control Panel**

The Control Panel is divided into five separate sections:

- Clock/Calendar
- Keyboard Response Selector
- Mouse Click Response
- Audio Feedback (Keyclick/Bell)
- Palette Control/Color Selector

**Note:** To save the changes you make with the Control Panel, use the Save Desktop option in the Options menu.

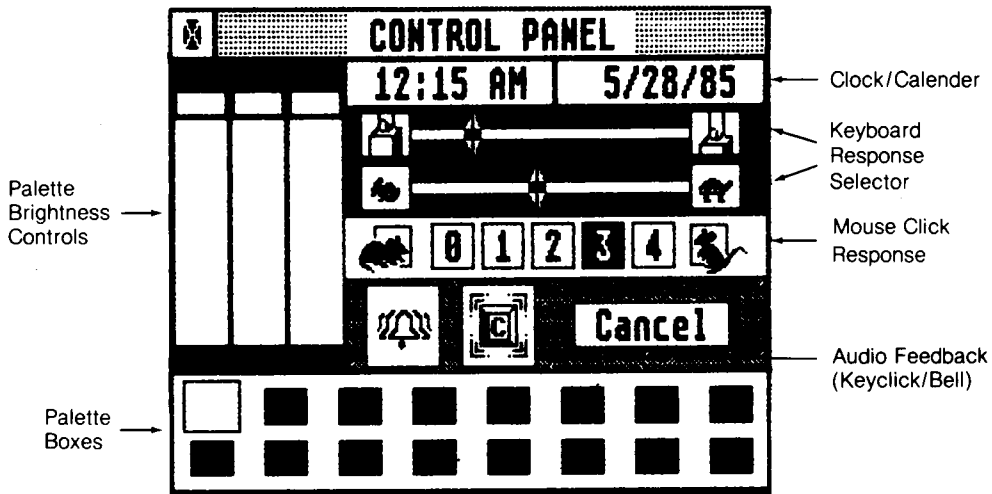

### **Clock/Calendar**

To set the clock or calendar, position the mouse pointer in the Clock window (left window) or the Calendar window (right window) and click the mouse button. The window will reverse shading and you can enter the correct time or date directly from the ST keyboard. When you finish, click in the window again and the clock and calendar will be set.

### **Keyboard Response Selector**

Every key on the ST Computer keyboard will repeat if you continue to hold it down. The Keyboard Response Selector controls how soon the keys start repeating and how quickly they repeat.

The Upper Slide controls how soon the keys start repeating after the key is held down: Moving the slider to the left makes the keys repeat sooner. The Lower Slider controls the repeat speed: Moving the slider to the left makes the keys repeat faster. To move the Slider, select and drag the indicator to the desired position.

This feature is very useful for adjusting the responsiveness of the cursor keys.

### **Mouse Click Response**

If you do not double-click quickly enough, the ST Computer may interpret the clicks as two separate single clicks. To make the double-click response time slower, click on one of the boxes closer to the Resting Mouse icon.

For experienced users, the slower click response time may be frustrating. To speed up the double-click speed, select one of the boxes nearer to the Running Mouse icon.

### **Audio Feedback**

The ST Computer has two kinds of audio feedback: A click after each keystroke and a bell after keyboard and mouse movement errors. (A common mouse movement error that sounds a bell is trying to select another function before you exit from a Dialog Box.) To activate or deactivate these audio features, click on the Keytop icon or the Bell icon on the Control Panel. A solid icon indicates that the function is active; a shaded icon indicates that it is disabled.

### **Palette Controls**

The Palette Controls are only functional when you use the ATARI SC1224 RGB Analog Color Monitor. The Palette Controls do not work with the ATARI SM124 Monochrome Monitor.

In low-resolution color display mode, the ST Computer can produce up to 16 colors at one time. The Palette Controls allow you to mix the three primary video colors (Red, Green, and Blue) to make a palette of the colors you want. To select one of the 16 colors, click on one of the Palette Boxes along the bottom of the Control Panel. To modify that color, move the three sliders in the color control section to the positions you desire. Each slider has eight positions. Selecting a position that is higher increases the brightness of that color.

To reset the setting on the Control Panel, click on the Cancel button. To exit the Control Panel, click on the Close Box in the upper left-hand corner.

## Set RS232 Configuration

The port labelled "Modem" on the back of the ST Computer is a RS232C serial port. This port is used most often to communicate from your computer through a modem to another computer. Select the Set RS232 Configuration option and the following Dialog Box will be displayed:

| RS232 PORT CONFIGURATION |      |        |      |     |
|--------------------------|------|--------|------|-----|
| Baud Rate:               | 9600 | 4800   | 1200 | 300 |
| Parity:                  | NONE | ODD    | EVEN |     |
| Duplex:                  | FULL | HALF   |      |     |
| Bits/Char:               | 8    | 7      | 6    | 5   |
| Strip Bit:               | ON   | OFF    |      |     |
| Flow Control             |      |        |      |     |
| Xon/Xoff:                | ON   | OFF    |      |     |
| Rts/Cts:                 | ON   | OFF    |      |     |
| OK                       |      | CANCEL |      |     |

This Dialog Box lets you match the configuration of the RS232C port with the configuration of the modem you are communicating with. Refer to the modem manual for specific information on which parameters to choose. The major choices are explained below.

### Baud Rate

Baud rate is the speed at which data is transmitted. (Baud is a measure of bits per second.) The fastest rate is 9600 baud; the slowest is 300 baud. You must set the baud rate to accommodate both modems.

### Parity

Whenever computers send information over the telephone lines, there is a chance that some of the information may get garbled, due to imperfections in the lines. Parity is a method that computers use to examine information and determine whether it is correct.

## Duplex

When you type on your keyboard, the ST Computer can determine whether or not you see the characters on your monitor screen. There are two modes that the VT52 Emulator program can choose from to handle this distinction. In the FULL Duplex mode, the computer *echoes* the characters you send on the monitor screen. In the HALF Duplex mode, the characters are echoed from the receiver's computer. To select the mode you want, use the Duplex command.

## Install Printer

This option lets you select the parameters to use different types of printers. Refer to your printer manual to determine which parameters to choose.

| Install Printer   |                               |                              |
|---|-------------------------------|------------------------------|
| Printer Type:   | <input type="radio"/> Dot     | <input type="radio"/> Daisy  |
| Color:  | <input type="radio"/> B/W     | <input type="radio"/> Color  |
| Pixels/Line:  | <input type="radio"/> 1280    | <input type="radio"/> 960    |
| Quality:  | <input type="radio"/> Draft   | <input type="radio"/> Final  |
| Printer Port:   | <input type="radio"/> Printer | <input type="radio"/> Modem  |
| Paper Type:   | <input type="radio"/> Feed    | <input type="radio"/> Single |
| <input type="button" value="OK"/> <input type="button" value="CANCEL"/> |                               |                              |

## FILE

The File Menu contains options that allow you to manipulate your files, manage your windows, create folders, and format disks.

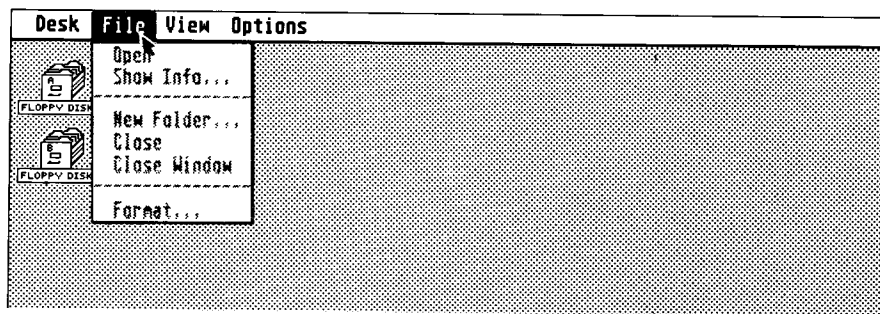

## Open

The Open option is used to begin a program or reveal the contents of a disk, a file, or a folder. To begin a program or open a file, select the program's icon, point to the Open option in the File Menu, and click the left mouse button once. You can also select a folder icon with the Open option and display the contents of that folder in the current window.

An alternative to this method is to select the program's icon and double-click the left mouse button.

## Show Info

When you select an icon and then select the Show Info option, information is displayed on the program, data file, or Desktop item that the icon represents. For example, the Show Info Dialog Box for a Floppy Disk icon might look like the following:

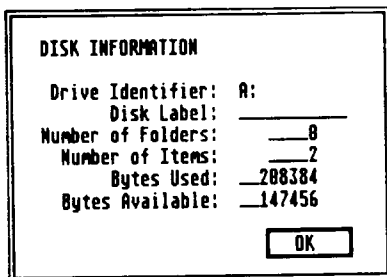

|                                   |        |
|-----------------------------------|--------|
| <b>DISK INFORMATION</b>           |        |
| Drive Identifier:                 | A:     |
| Disk Label:                       | _____  |
| Number of Folders:                | 8      |
| Number of Items:                  | 2      |
| Bytes Used:                       | 288384 |
| Bytes Available:                  | 147456 |
| <input type="button" value="OK"/> |        |

The Show Info option identifies the disk, lets you label the disk, gives the number of folders and items, and the number of bytes used and available. You can use this option to manage your files on a disk.

You can also rename a file with the Show Info option. Press the **[Backspace]** key to delete the filename, type a new name, and either press the **[Return]** key or click on the OK button to write the new filename on the disk.

**Note:** The ST Computer reserves 1024 bytes on the disk for each file, even if the file is smaller. Depending on the number and size of your files, the number of bytes used plus the number of bytes available may not equal the exact storage capacity of the disk. This is caused by the reserved byte factor for each file. The Bytes Used and Bytes Available options should be used to monitor your disk storage capacity.



## New Folder

Folders are collections of files you create to help organize your files. When you turn on your ST System, there won't be any folders unless you have created and saved folders beforehand. You'll need to use the New Folder option to create them. Open your Floppy Disk icon, select the New Folder option, and this Dialog Box will be displayed:

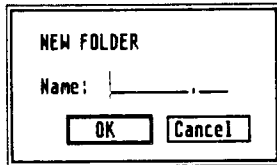

When you have given the new folder a name and clicked on the OK button, your new folder's icon will appear in the current window (the one that you are working in).

To put your files into the folder, simply drag them into the new folder. When the folder icon is shaded, release the left mouse button, follow the prompts in the Dialog Box and the file will be copied into the folder.

For detailed procedures on creating and managing folders, see **Chapter 6, *Managing Disks, Files, and Folders***.

## Close

There are three ways to close a window. If you have a window on your screen and you don't want it displayed, you can either select the Close or Close Window options from the File menu, or you can click on the window's Close Box.

It is always a good idea to put windows away if you are not using them. You can only have four windows open on the GEM Desktop at any one time and any extra open windows will use up some of the available Desktop space.

The Close option will close only the active window, not all the windows on the GEM Desktop. The Close option or Close Box will also close down the most recently opened folder. If you are not within a particular folder, the window itself will close.

## Close Window

The Close Window option closes down all the folders and removes the window from the GEM Desktop.

## Format

The surface of a floppy disk is similar to a record. The information that you store on the disk is recorded in circular patterns. Unlike a record, however, the patterns are not in place when you first buy the disk; you must put them onto the disk before you can use it. The process of preparing a disk to accept data is called "formatting". To format a disk, select the Floppy Disk icon to be formatted, then select the Format option from the File menu, and the first Format Box will be displayed.

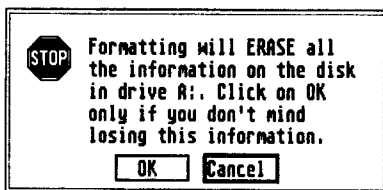

Insert a blank disk in your disk drive, click on the OK button, and this Dialog Box will be displayed:

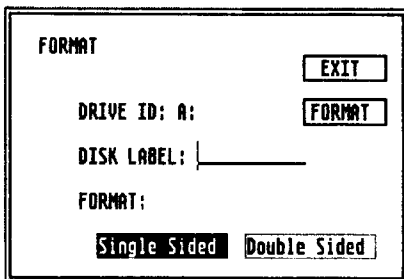

To name the disk, type in the name using the ST Computer keyboard. Use the [Backspace] key to delete any errors. If you are using the ATARI SF354 Disk Drive, the single-sided option should be shaded. Choose the double-sided option if you are using the ATARI SF314™ Disk Drive. To change the option, click on the option space and the shading will reverse. Once you have made your selection, click on the Format button and your disk will be formatted. Follow the prompts to switch disks. A Working Box will monitor the formatting process.

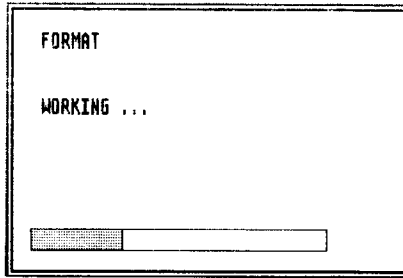

When the disk is formatted, you will see the following Dialog Box. If your disk doesn't have 357,376 bytes available, the disk is defective. Place a new disk in the disk drive and format it.



Click on the Exit button and you will be returned to the Format Box. If you don't want to format another disk, click on the OK button and return to the GEM Desktop.

**Note:** You can reformat old disks, but if you do, any data that was on the disks will be lost.

## VIEW

The View Menu allows you to display your files by Icon and Text, and sort by Name, Date, Size, or File type.

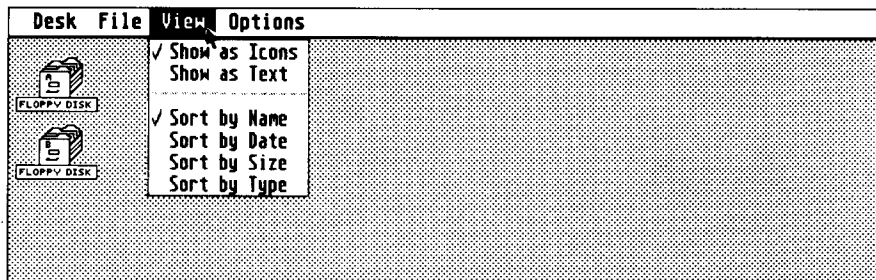

When displaying a file, the check mark in front of the option indicates how the display is set. To modify the file display, select the option you want by clicking on it. The following two windows show a file display as Icons and as Text for the same disk.

### Show as Icons

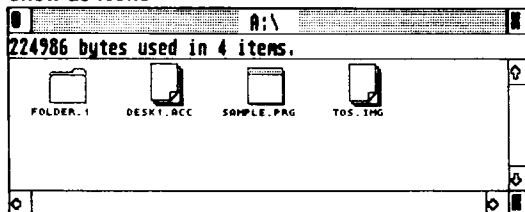

### Show as Text

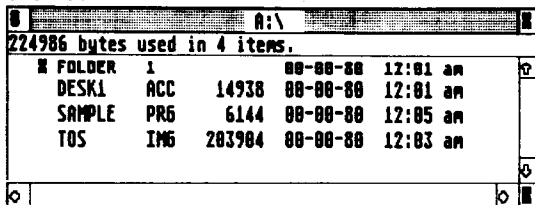

The icon next to "Folder" in the Text window indicates that the file is a folder, not an application, or data file. The Text window also shows the filename and size, and the date and time the file was last modified.

## OPTIONS

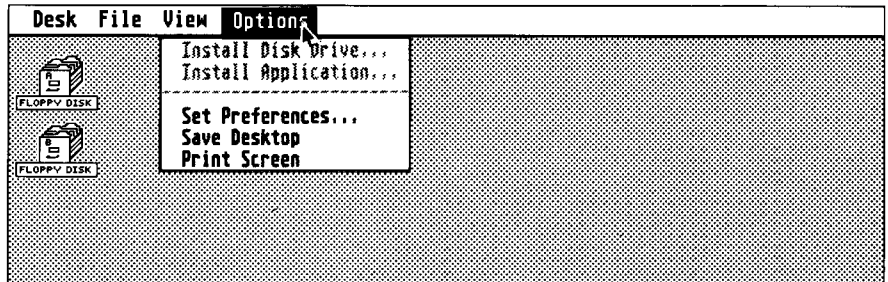

### Install Disk Drive

When you turn on your ST System, two Floppy Disk icons are displayed. Each disk has a disk identifier (a letter) and an icon label. You can change the identifier, remove a disk icon, or add a disk icon by using the Install Disk Drive option. Select a disk icon, then select the Install Disk Drive option. The following Dialog Box will be displayed:

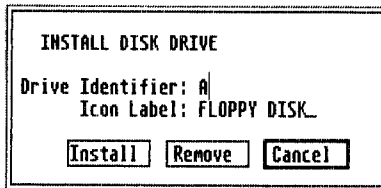

To change the disk identifier or icon label, point at the item you want to change and click the left mouse button. Press the **[Backspace]** key on the ST Computer keyboard to erase the current name and type in any name you wish.

**Warning:** Use the Install Disk Drive option with caution. If you remove both disk icons and then save this new Desktop on your System Backup disk, you'll need to make a new System Backup disk to get the disk icons functioning again.

**Note:** To save the changes made using the Install Disk Drive option, use the Save Desktop option.

## Install Application

With the Install Application option, you can change the way an application program will run, or you can determine the kind of data file that will open an application. With an application program open in a window, select the Install Application option from the Options Menu. The following Dialog Box will be displayed:

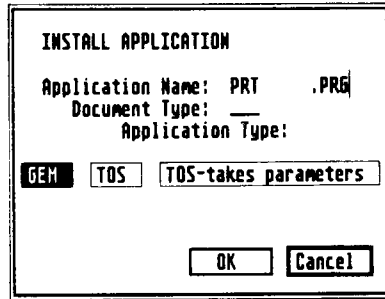

INSTALL APPLICATION

Application Name: PRT .PRG  
Document Type: \_\_\_  
Application Type:

GEM    TOS    TOS-takes parameters

If you want the program to receive a data file before it begins to run, choose one of the three options. Choose "GEM" if you have an application that takes advantage of the special features of GEM. Choose either "TOS" or "TOS-takes parameters" if your program doesn't use the features of GEM.

You can also determine the type of data files that will open an application. If, for example, you are using ATARI Logo™ and you have a data file that has a filename extender (the three letters that follow the period in the filename) of LOG, you can set Logo to run from this extender. Type LOG after the Document Type option and click on the OK button. You can now select any data file with a .LOG extender and Logo will run automatically. To use this feature, the application file must be in the same window as the data file.

**Note:** To save the changes made using the Install Application option, use the Save Desktop option.

## Set Preferences

The Set Preferences option lets you determine how the ST Computer will interact with you through the prompts and Dialog Boxes, and what resolution your monitor display will be in.

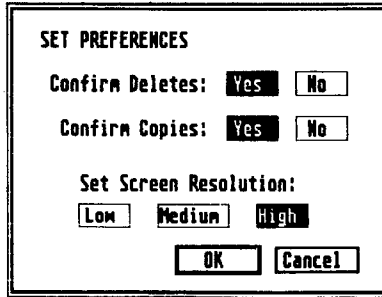

The first two options — Confirm Deletes and Confirm Copies — determine if the ST Computer will wait for confirmation before making a copy or deleting a file. You can set up the warning system to suit your own needs.

The third selection — Select Screen Resolution — allows you to select one of the three screen resolutions: Low, Medium, or High. With the ATARI SM124 Monitor you can select only high resolution. With the ATARI SC1224 Analog Color Monitor you can select either medium or low resolution.

**Note:** To save the changes made using the Set Preferences option, use the Save Desktop option.

## Save Desktop

To save all your modifications to the GEM Desktop, use the Save Desktop option. Click on the option and the modifications are saved.

**Note:** You must have your System Backup disk in your disk drive to save changes to any part of the GEM Desktop.

## Print Screen

This option prints the screen, including the mouse pointer, on a graphics printer. Click on the option to activate the Print Screen function.

# CHAPTER 6 MANAGING DISKS, FILES, AND FOLDERS

## DISKS

Most of the information you load into your ST Computer will be stored on 3-1/2 inch microfloppy disks. With disks and a disk drive you can load information into the computer and store the programs or data that you create yourself.

### Write-Protecting Disks

When you write-protect a disk, you prevent information from being "written to" the disk. To "write to" simply means to put information on the disk. (Similarly, to "read" a disk means to retrieve information recorded on the disk.)

**Top of Disk**

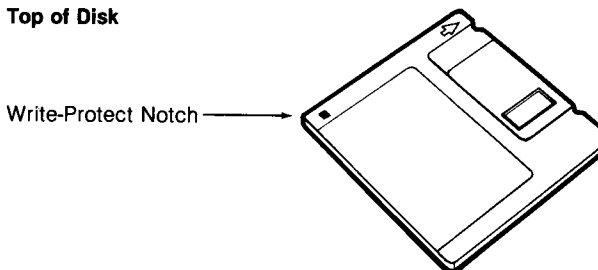

**Bottom of Disk**

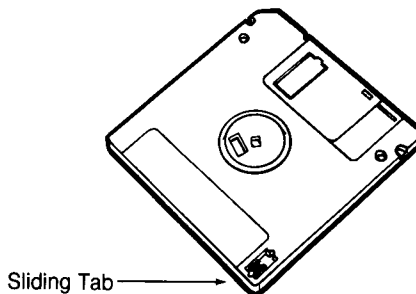





Most disks have a small write-protect notch at the lower left-hand corner of the disk's plastic casing. Turning the disk over, you will see a small, sliding tab. To write-protect a disk, slide the tab so that you can see through the notch.

If your disk does not have a write-protect notch visible on the lower left-hand corner, you may still be able to write-protect it. On the back of the disk, there should be a sliding tab in the lower right-hand corner. Push the tab to the bottom position to write-protect the disk.

While write-protected, a disk cannot be formatted, erased, or written to. Of course, you can move the write-protect tab back to the unprotected position anytime you wish to record information on the disk.

Commercial program disks do not usually have write-protect tabs. These disks are permanently write-protected as a safety precaution. The TOS System disk you received with the ST System is permanently protected. You cannot format, erase, or write to the TOS System disk.

Before duplicating a disk or copying files from one disk to another, it is recommended that you write-protect the disk you are duplicating or copying files from. Doing so safeguards you against mistakenly inserting your original disk when the drive is ready to write information on the duplicate. Such confusion is likely when you are using a single disk drive to duplicate disks or copy files.

### **Caring For Your Microfloppy Disks**

- Never place disks near any source of magnetism (monitor, television, electric motor, or telephone).
- Avoid placing the disks near sources of heat and moisture.
- Never touch or clean the surface of the disk.
- Never leave the disks in direct sunlight.

# FILES

When you open a disk icon, the window can display three types of file icons: programs you can run; non-program data files to use with an application program; or folders which contain other files.

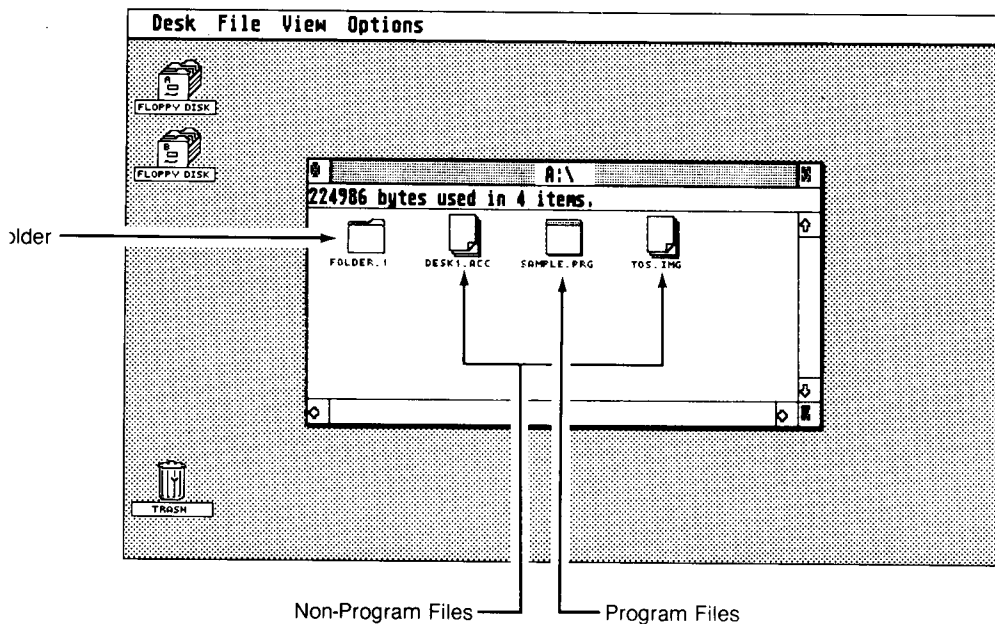

## Copying Files

With many computers, copying files is a complicated process involving numerous commands. On the ST Computer, to copy any type of file, you select that file's icon and drag it over to where you want to put the copy. If you want to put a copy of a file onto another disk, drag the icon over to and on top of the icon for that disk.

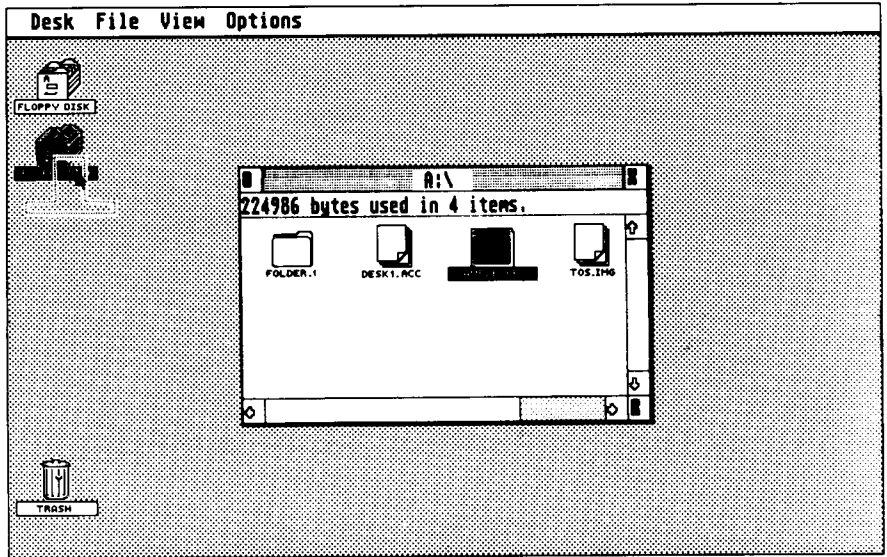

You can also copy files when the file is shown as text, not as an icon. Use the View heading on the Menu Bar to change the file display to text.

The Copy Box will be displayed whenever you copy a file. Click on the OK button to complete the copying process.

**Note:** If you don't want a Copy Box to be displayed, select "No" under the Confirm Copies choice in the Set Preferences option.

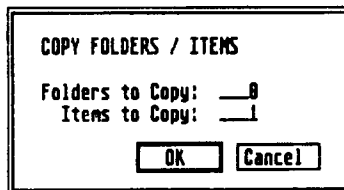

If you want to put a copy into a specific folder on a disk, you can drag the file's icon into that folder.

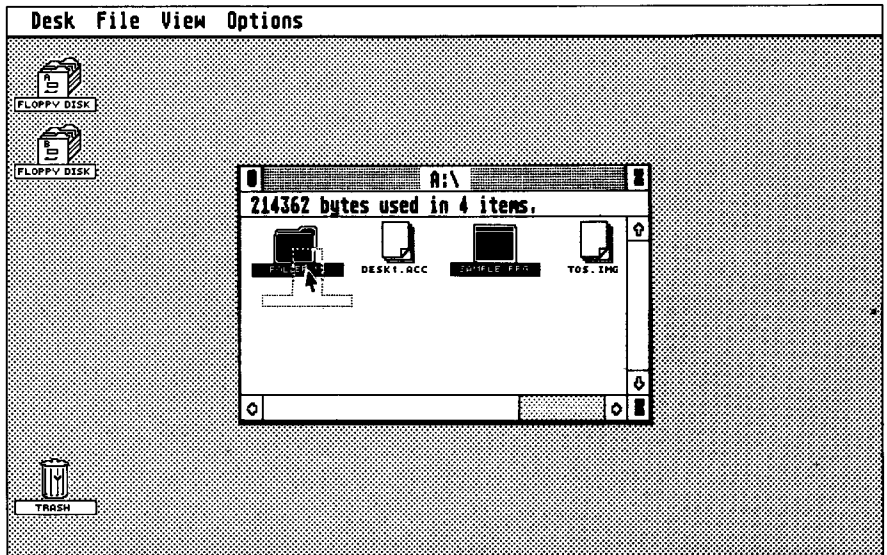

You can copy a file into a folder when both are shown as text. Select and drag the file's text line into the folder's text line.

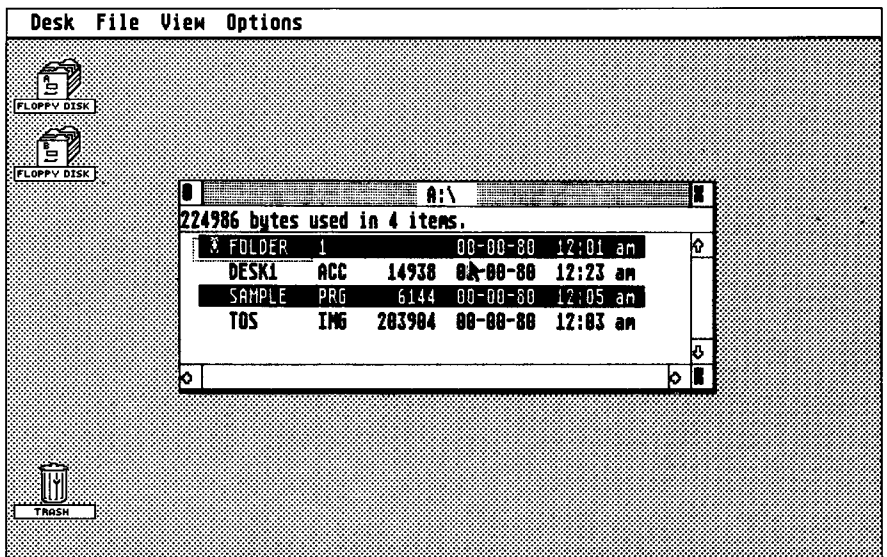

## Deleting Files

To delete a file, select and drag the file to the Trash icon and follow the prompts. Remember: Once you put something into the Trash, it is gone forever.

## Renaming Files

To rename an existing file, select the file, point at the File heading on the Menu Bar, and select the Show Info option.

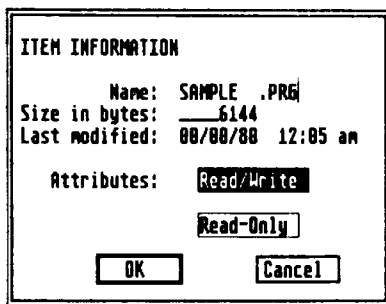

This sample Dialog Box shows the name and attributes of an opened file. You see a cursor (the vertical line) at the end of the filename. To change the filename, press the **[Backspace]** key on the ST Computer keyboard until the old name is deleted and the cursor is at the beginning of the name block. Then type in the new name.

**Note:** It is generally best to leave the three-character extension on the filename unchanged. If you do change the extender, you may make the data in that file inaccessible to the system.

## FOLDERS

Folders are neither programs nor data; they are a means of organizing your icons. If you have a window that contains numerous icons, it can become difficult to distinguish any one icon from the others. Like any filing system, you need to organize your information to make it accessible. The GEM Desktop allows you to create folders in which to store your files.

## Creating Folders

To create a folder, select and open a Floppy Disk icon, point at the File heading on the Menu Bar and select the New Folder option. This Dialog Box will be displayed:

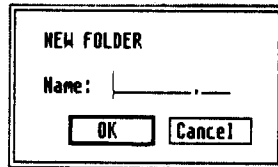

Type in a name for the folder and click on the OK button. If you change your mind about adding a folder, click on the Cancel button instead. To delete a folder later, drag it into the Trash icon.

Once you have a folder on the GEM Desktop, you can copy files into that folder by dragging the file icons into the folder. Refer to the Copying Files section for more information on copying files into folders.

**Note:** Copying a file into a folder creates a new copy of the file and places it in the folder. After you have placed a copy of the file into the folder, you can delete the old file by dragging its icon into the Trash icon.

## Opening Folders

Every disk and every folder may be opened to its own window. If you open a Floppy Disk icon that contains several folders, you won't be able to see the contents of those folders until you open them. To open a folder, either double-click on the folder's icon or select the icon (by single-clicking), and choose the Open option under the File heading.

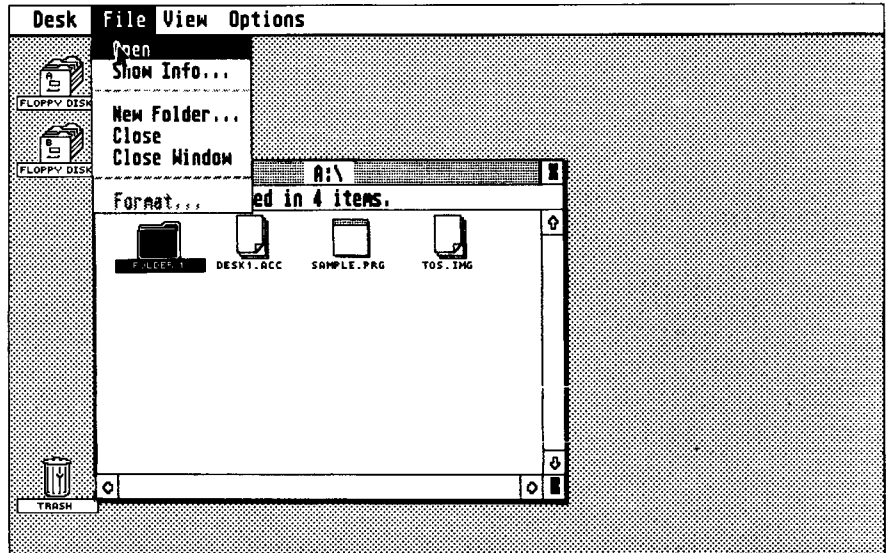

The screen below shows an opened window for Folder 1. Look at the Information Line. You can see that the folder is empty with 0 bytes used in 0 items.

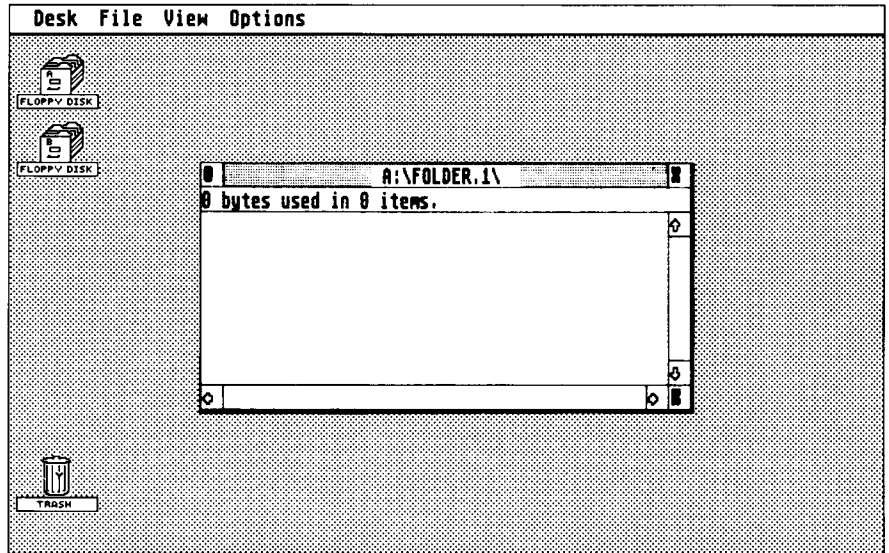

If you wish to open two folders at once (to copy data from one folder to another), double-click on the Floppy Disk icon again to open another window for that floppy disk. Double-click on the next folder to open it into the second window.

**Note:** You can only have four windows open at one time. If you try to open a fifth window you will see a Dialog Box with an Alert Message. If you need to view a fifth window, close one of the opened windows first.

### **Deleting Folders**

To delete a folder, select and drag the folder to the Trash icon and follow the prompts.





## **CHAPTER 7**

# **APPLICATIONS FOR THE ST COMPUTER**

The special characteristics of the ST Computer are being used to full advantage in a number of new application programs, including ATARI Logo™, ATARI BASIC™, and GEM programs.

### **ATARI LOGO**

Logo is a powerful programming language, best known for its use with students who are beginning programmers. Logo was developed to work with turtle graphics, a special system where an imaginary turtle draws lines and shapes under the program's control. Unlike other programming languages, you can learn programming through graphics without any understanding of higher math.

ATARI Logo is an expanded version of the language. It takes advantage of the mouse, the drop-down menus, and the windows of the GEM Desktop, the speed of the 68000 microprocessor, and incorporates an array of new Logo commands not found in any other version of the language. ATARI Logo is a language specifically created to take advantage of the special qualities of the ST Computer.

For more information on ATARI Logo, refer to the manual, *A Sourcebook For ATARI Logo*. Contact Atari Customer Service for availability information.

### **ATARI BASIC**

BASIC was originally designed to be an easy-to-learn, yet powerful programming language. And today, it is the most commonly used computer programming language. ATARI BASIC is similar to the mainstream dialects of BASIC, yet takes advantage of the unique features of the ST Computer.

ATARI BASIC contains a full complement of string manipulation functions, advanced math features, and print formatting commands. The ATARI BASIC editor uses the windows and drop-down menus of the GEM Desktop to full advantage, featuring windows for both text and graphics.

For detailed information on ATARI BASIC refer to the manual, *A Sourcebook For ATARI BASIC*. Contact Atari Customer Service for availability information.



## **GEM Programs**

Many software programs are being developed for the ST Computer and its GEM Desktop. GEM Write™, a word processing program that uses the windowing capabilities of GEM on the ST Computer is being developed. GEM Write will accept graphics developed with GEM Draw™ and GEM Graph™, letting the writer mix text and graphics into a sophisticated presentation package.

GEM Draw and GEM Paint are full-featured graphics programs. GEM Draw creates graphics for use in business or drafting applications; GEM Paint is developed for the casual painter and artist. The drawings and paintings created with these programs can be integrated into GEM Write or stored as separate files. Both programs use the standard features of the GEM Desktop and make full use of color on the ST Computer.



## APPENDIX A TROUBLESHOOTING

**Q.** I have set up my computer according to the instructions in **Chapter 2, *Setting Up the ST System***, but when I turn on the computer, the screen stays dark. What do I do now?

**A.** If the GEM Desktop doesn't appear when you turn on your computer and load your TOS System disk, retrace your steps. Make sure that all cords and cables are plugged in securely, that power is coming into the system, and that the brightness adjustment on your monitor is turned up. If the display is still not proper, your computer or your monitor may need service. For the location of the nearest Atari Service Center, contact your Atari retailer or write: Atari Customer Relations, P.O. Box 61657, Sunnyvale, CA 94088. Write "Service Center Information" on the outside of the envelope.

**Q.** The GEM Desktop appears when I turn on the computer, but no icons are visible.

**A.** This may happen if the disk is unformatted, damaged, improperly inserted in the drive, or if the drive is improperly connected to your computer. A Dialog Box with an Alert message and possible remedies may appear. Make certain you have a functioning TOS System Disk in Drive A and that the drive is properly connected and turned on.



**Q.** When I press the [Help] or [Undo] keys, nothing happens. Why not?

**A.** Both the [Help] and [Undo] keys are designed to work with certain programs. If the computer doesn't respond, the program that you are using is probably not set up for use with the [Help] or [Undo] keys.

**Q.** When I move the mouse, the mouse pointer doesn't move as well.

**A.** Make sure the mouse is plugged firmly into Mouse/Joystick port 0. See Appendix B, *Mouse Care*.

If the mouse seems to be working properly, turn the computer off, insert a different disk, then turn it on again. If using a different disk doesn't help, contact your Atari retailer or Atari Customer Relations, P.O. Box 61657, Sunnyvale, CA 94088. Write the subject of your inquiry on the outside of the envelope.

**Q.** When I type on the keyboard, nothing appears on the screen.

**A.** You may not be in a situation that permits typing. But you should be able to move the mouse pointer around the GEM Desktop with the [Alternate] and cursor keys, and activate the Desktop functions with the [Alternate] and [Insert] keys.



## **Other Problems**

If none of the solutions in this Appendix seems to help, the problem may be in one of the following areas:

- The application program may have suffered a momentary failure.
- The information on your disk may be garbled.
- Your ST Computer or one of the peripherals may need repair.

The best way to test for program failure is to turn your computer off for a few seconds, then on again. If this helps, the program may have experienced momentary failure. If this doesn't help, but trying another disk does, the problem was with the first disk. If none of your disks work correctly, your ST Computer or peripherals may need repair.

## APPENDIX B MOUSE CARE

Your ST Mouse will last through many years of use if you treat it properly.

Two guidelines for proper mouse care:

1. Don't drop the mouse or allow it to "hang by its tail".
2. Make sure the surface on which you use the mouse is as smooth and as clean as possible.

### CLEANING THE MOUSE

You'll need to give the mouse a periodic cleaning to ensure proper operation. This is a simple operation. Follow the steps below.

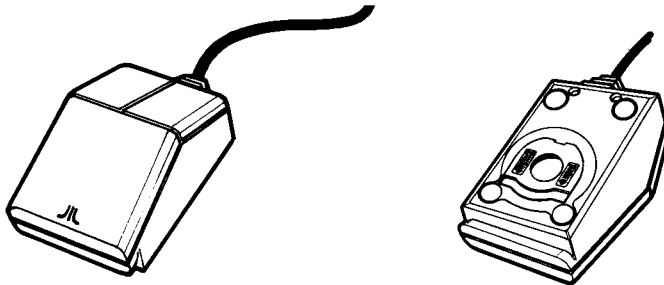

1. Turn the mouse upside down in your hand with the cable pointing towards you.
2. Place two fingers on the arrow symbols on either side of the roller opening on the bottom of the mouse. Push down and away from you until the panel pops out.
3. Hold one hand over the mouse and turn it over so the ball drops into your hand.
4. Use a clean, soft, and dry cloth to wipe the ball clean. *Never use a cleaning fluid or lint-creating tissue.*
5. Gently blow into the mouse housing to get rid of any dust.
6. Replace the ball in its housing, then reinsert the retaining panel. When the panel is in place, push it down and backwards until it locks firmly in place.

## APPENDIX C GLOSSARY

**Alert Messages** Alert messages inform you that the operation you are performing is improper or impossible. Alert messages are always displayed in a Dialog Box.

**Baud Rate** The speed at which characters are transmitted from one source to another. You can transmit information from your computer through a modem over the telephone lines to another computer. The baud rate is a measure of bits per second.

**Bit** The smallest unit of computer memory. Eight bits equal one byte of memory.

**Byte** Computer memory is arranged into units called bytes. Each byte consists of eight memory units called bits. Each byte is a unique character within the computer. (See Bit and Kilobyte.)

**Cartridge** One of four methods of entering data and/or programs into the ST Computer. The other methods are using a disk drive, the keyboard, or an external port (i.e., Modem port).

**Click** Click means to point the mouse pointer at a word or icon on the screen, press the mouse button, and then release it quickly.

**Close Box** A small box at the upper left-hand corner of a window used to close the window.

**Color Palette** One function of the Control Panel that allows you to modify the colors available on the ST Computer. You must have the SC1224 RGB Analog Color Monitor for the Color Palette to function.

**Control Panel** A Dialog Box that allows you to control many of the GEM Desktop functions. The Desktop colors (on a RGB Analog monitor), Mouse Click Response, Keyboard Response, Clock/Calendar, and Audio Feedback Prompts are adjustable through the Control Panel.

**Cursor** A marker that appears on the screen to indicate the position of the next typed character.

**Daisy Chaining** A method of connecting two or more devices to the computer using an interface cable to link each peripheral device to the previous one.

**Data File** A collection of information that can be used by a program. Data files are not programs.



**Desk Accessory** An application program that can be used at most times, while using another program or directly from the GEM Desktop.

**Dialog Box** Dialog Boxes are interactive message boxes. To exit a Dialog Box you must acknowledge the message or choose an option.

**Disk Copy** A program that makes an exact copy of all of the data on a disk. To make a disk copy, drag the icon of the source disk on top of the icon for the destination disk.

**Disk Drive** A peripheral device the ST Computer uses to read information from or write information to a floppy disk. Disk drives are represented by a Floppy Disk icon on the GEM Desktop.

**Double-Click** A double-click is two, quick clicks on the left mouse button. A double-click opens a file, disk, or folder.

**Drag** Dragging is the technique for moving an icon or window. Point at a moveable object on the GEM Desktop with the mouse pointer, press the left mouse button, and hold the button down while moving the mouse. While dragging the icon, a ghost of the icon you are moving will appear on the Desktop.

**File** A file is a collection of information that has been stored or can be stored on a disk or in the computer's memory.

**File Copy** To copy single files from one disk to the other, drag the icons that represent the files you want to copy over to and on top of the new disk's icon. You can also drag files between the opened windows of two disks.

**Floppy Disk** A device used to store information. The disk is made of a material that is similar to the tape in audio cassettes.

**Folder** A folder is a collection of files. You can place files into folders and then remove the files from the main Floppy Disk window. To access a file that has been placed in a folder, double-click on the folder's icon.

**Format** Information is stored on your floppy disk in circular patterns. When you format a disk, you set the patterns so information can then be stored in those patterns. Formatting is also referred to as "initializing".

**Full Box** Used to enlarge and reduce the size of a window from normal size to full-screen size.





**GEM** Graphics Environment Manager. A program used with the TOS Operating System which creates and manages all the icons and graphics features of the ST Computer.

**GEM Desktop** The main screen for the ST Computer. It includes the Menu Bar, two Floppy Disk icons, and the Trash icon.

**Ghost Icon** An outline of an icon or window used to show the current position of the icon or window as it is being dragged to a new location on the GEM Desktop.

**Hard Disk** A storage device used to store data on a magnetic surface. A hard disk can store far more data than a floppy disk (more than ten million bytes of data vs. a typical maximum of one million bytes on a floppy disk). The hard disk drive can also read and write information up to ten times faster than the floppy disk drive.

**High-Resolution** One of three video display modes accessible to the ST Computer. In high-resolution mode, the ST Computer display consists of 640 dots horizontally and 400 dots vertically. In high-resolution mode, the ST Computer will only display black and white dots. (See Low-Resolution and Medium-Resolution.)

**I/O** Input/Output. The communication process that takes place between the ST Computer and its peripheral devices (i.e., disk drives, printers). Input is information that is sent "in" to the computer; output is information the computer sends "out".

**Icon** A picture used by the GEM Desktop to represent various kinds of files, programs, and procedures.

**Information Line** A line at the top of a window telling how much of the disk's storage capacity is filled and with how many items.

**Interface** An electronic connection that allows communication between the computer and its peripheral devices.

**Kilobyte** 1024 bytes. (See Bit and Byte.)

**LOGO** A powerful programming language available on the ST Computer.

**Low-Resolution** One of three video display modes accessible to the ST Computer. In low-resolution mode, the ST Computer display consists of 320 dots horizontally by 200 dots vertically. In this mode, the ST Computer can display up to sixteen colors at a time from the total palette of 512 colors.



**Medium-Resolution** One of the three video display modes accessible to the ST Computer. In medium-resolution mode, the ST Computer display consists of 640 dots horizontally by 200 dots vertically. In this mode, the ST Computer can display up to four colors at a time from the total palette of 512 colors.

**Memory** The electronic circuits that the ST Computer uses to store data and programs are its memory. There are two kinds of memory: RAM (Random Access Memory) and ROM (Read Only Memory). RAM loses its data if the power is turned off; ROM retains its information whether it has power or not.

**Menu Bar** When you first start up the ST Computer System, the headings on the Menu Bar at the top of the GEM Desktop are: Desk, File, View, and Options. Depending upon the application program you are using, you may have different headings.

**MIDI Interface** MIDI stands for Musical Instrument Digital Interface. It is a standard interface designed to connect a computer to a number of electronic musical devices.

**Modem** A device that allows you to connect your computer directly to the telephone lines and establish a communication link with other computers and on-line information networks.

**Mouse** The mouse controls the movement of the mouse pointer on the GEM Desktop. As you slide the mouse across your table or desk, the small rubber ball on the bottom rolls back and forth to track the movements. The mouse has two buttons. The left button is used to select and open files, icons, and programs. The right button is used with special application programs.

**Move Bar** A bar at the top edge of a window. Click on the Move Bar to drag a window to a new location on the GEM Desktop.

**Parallel Interface** This connector is a standard for high-speed printer connections. On the back of the ST Computer, the parallel interface port is labeled "Printer"

**Peripheral** Any kind of peripheral device that you connect to your computer (i.e., disk drive, monitor, printer).

**Pixel** The ST Computer video display is made up of tiny dots called pixels. The pixels are arranged in a grid, and set to either 320 x 200, 640 x 200, or 640 x 400 dots per grid.

**Pointer** The pointer (also called the mouse pointer) is used to point to objects on the GEM Desktop. It follows your movement of the mouse (or cursor keys) forward, backward, left, or right.



**RAM** Random Access Memory. The part of the computer's memory that is used to "write to" and "read information from". When you work with your computer, the display on the screen is in RAM. The information stored in RAM is lost each time you turn off the computer.

**RGB** Red, Green, Blue. The color signals that the ST Computer produces to create its special color display. The combination of eight different intensities of red, green, and blue enable you to create 512 colors with the ST Computer.

**ROM** Read Only Memory. The part of the computer's memory containing the start-up information for the computer. The ROM is programmed at the factory and never changes.

**RS232C** The RS232C connector is a standard connection for peripheral devices. On the back of the ST Computer this connector is labeled "Modem". The RS232C port is also referred to as the serial port. Serial printers can be connected to the ST Computer through this port.

**Scroll** To move the information in a GEM Desktop window left, right, up, or down.

**Scroll Arrow** There may be up to four Scroll Arrows—up/down and left/right—on each window. Clicking the Scroll Arrow scrolls the window in the direction of the arrow.

**Scroll Bar** One of two bars that border a window on the bottom and right edges. The Scroll Bars contain the Scroll Arrows and the Scroll Box used to move the insides of the window.

**Scroll Box** A rectangular box inside the Scroll Bar that shows the relative size and position of the data shown in a window. The larger the Scroll Box the greater the percentage of the complete window is visible.

**Sector** A section of a track on a hard or floppy disk. Sectors are usually 128, 256, 512, or 1024 bytes long. On the ST Floppy Disk, the sectors are 512 bytes. (See Track.)

**Size Box** A small box at the lower right-hand corner used to change the size of the window.

**Sizing** The process of changing the size or shape of a window.



**System Backup Disk** The system disk contains the programs that the ST Computer needs to operate. You must use this disk to start the ST Computer. You make a System Backup disk by copying the TOS System disk that came with your ST Computer System.

**TOS** The ST Operating System. TOS controls how the computer operates the GEM Desktop, the mouse, and any peripheral devices you connect to the computer.

**Track** One of the circular paths on a disk that contains the data that is written on the disk. Each track is made up of smaller sections called sectors.

**Trash** The GEM Desktop icon used to delete files or folders from the Desktop. Once a file or folder is put in the Trash icon, it is permanently deleted.

**VT52 (Terminal) Emulator.** A communications program that you can use to send data over telephone lines or directly to another computer.

**Window** The work area that the ST Computer uses to display files or folders, or to run programs. You can have four windows open at any time.

**Write-Protect** To mechanically prevent a disk from being written to. To write-protect a disk, move the write-protect tab so you can see through the Write-Protect Notch, or so the tab is at the bottom position in the notch.

# APPENDIX D CONNECTOR PINOUT SPECIFICATIONS



## Power

- 1 — + 5 VDC
- 2 — Not Connected
- 3 — Ground
- 4 — + 12 VDC
- 5 — -12 VDC
- 6 — + 5 VDC
- 7 — Ground

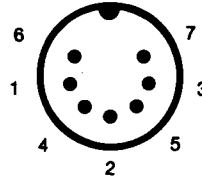

## Midi Out

- 1 — THRU Transmit Data
- 2 — Shield Ground
- 3 — THRU Loop Return
- 4 — OUT Transmit Data
- 5 — OUT Loop Return

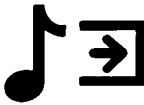
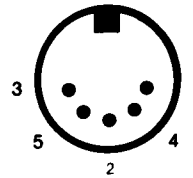

## Midi In

- 1 — Not Connected
- 2 — Not Connected
- 3 — Not Connected
- 4 — IN Receive Data
- 5 — IN Loop Return

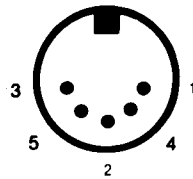

## Monitor

- 1 — Audio Out
- 2 — Reserved
- 3 — General Purpose Output
- 4 — Monochrome Detect
- 5 — Audio In
- 6 — Green
- 7 — Red
- 8 — Ground
- 9 — Horizontal Sync
- 10 — Blue
- 11 — Monochrome
- 12 — Vertical Sync
- 13 — Ground

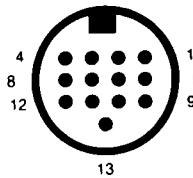

**Note:** All pinout diagrams are from the external port view.



## Printer

- 1 — STROBE
- 2 — Data 0
- 3 — Data 1
- 4 — Data 2
- 5 — Data 3
- 6 — Data 4
- 7 — Data 5
- 8 — Data 6
- 9 — Data 7
- 10 — Not Connected

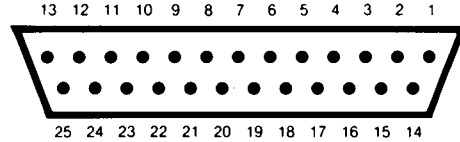

- 11 — BUSY
- 12-17 — Not Connected
- 18-25 — Ground



## Modem

- 1 — Protective Ground
- 2 — Transmitted Data
- 3 — Received Data
- 4 — Request to Send
- 5 — Clear to Send
- 6 — Not Connected
- 7 — Signal Ground
- 8 — Data Carrier Detect
- 9-19 — Not Connected
- 20 — Data Terminal Ready

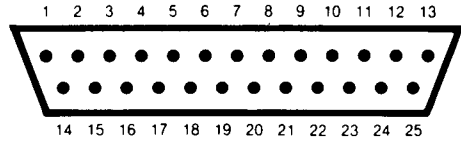

- 21 — Not Connected
- 22 — Ring Indicator
- 23-25 — Not Connected



## Floppy Disk

- 1 — Read Data
- 2 — Side 0 Select
- 3 — Logic Ground
- 4 — Index Pulse
- 5 — Drive 0 Select
- 6 — Drive 1 Select
- 7 — Logic Ground
- 8 — Motor On
- 9 — Direction In
- 10 — Step
- 11 — Write Data

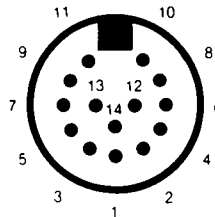

- 12 — Write Gate
- 13 — Track 00
- 14 — Write Protect



## Hard Disk

- 1 — Data 0
- 2 — Data 1
- 3 — Data 2
- 4 — Data 3
- 5 — Data 4
- 6 — Data 5
- 7 — Data 6
- 8 — Data 7
- 9 — Chip Select
- 10 — Interrupt Request
- 11 — Ground
- 12 — Reset
- 13 — Ground

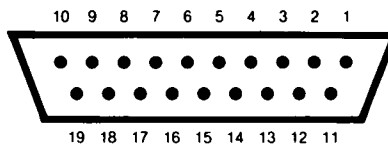

- 14 — Acknowledge
- 15 — Ground
- 16 — A1
- 17 — Ground
- 18 — Read/Write
- 19 — Data Request

## Cartridge

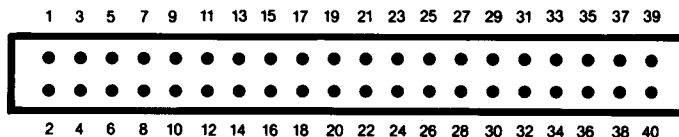

- 1 — +5 VDC
- 2 — +5 VDC
- 3 — Data 14
- 4 — Data 15
- 5 — Data 12
- 6 — Data 13
- 7 — Data 10
- 8 — Data 11
- 9 — Data 8
- 10 — Data 9
- 11 — Data 6
- 12 — Data 7
- 13 — Data 4
- 14 — Data 5
- 15 — Data 2
- 16 — Data 3
- 17 — Data 0
- 18 — Data 1
- 19 — Address 13
- 20 — Address 15
- 21 — Address 8
- 22 — Address 14
- 23 — Address 7
- 24 — Address 9
- 25 — Address 6
- 26 — Address 10
- 27 — Address 5
- 28 — Address 12
- 29 — Address 11
- 30 — Address 4
- 31 — ROM Select 3
- 32 — Address 3
- 33 — ROM Select 4
- 34 — Address 2
- 35 — Upper Data Strobe
- 36 — Address 1
- 37 — Lower Data Strobe
- 38-40 — Ground



## Mouse / Joystick

- 1 — Up/XB
- 2 — Down/XA
- 3 — Left/YA
- 4 — Right/YB
- 5 — Not Connected
- 6 — Fire/Left Button
- 7 — +5VDC
- 8 — Ground
- 9 — Joy1 Fire/Right Button

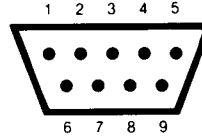

## Joystick

- 1 — Up
- 2 — Down
- 3 — Left
- 4 — Right
- 5 — Reserved
- 6 — Fire Button
- 7 — +5VDC
- 8 — Ground
- 9 — Not Connected

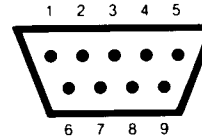



# APPENDIX E

## ATARI 520ST SPECIFICATIONS

|  |  |
|--|--|
| <b>Processor:</b>                        | MC68000, 32-bit internal, 16-bit external architecture. 8 MHz clock frequency  |
| <b>Memory:</b>                           | 524,288 bytes of RAM, 16,384 bytes of ROM  |
| <b>Floppy Disk Capacity:</b>             | 360 Kilobytes per formatted disk surface, 3.5 inch media   |
| <b>Graphics Resolution (selectable):</b> | 640 x 400 monochrome<br>320 x 200 x 16 colors<br>640 x 200 x 4 colors  |
| <b>Color:</b>                            | Palette—512 Colors   |
| <b>Interfaces:</b>                       | Midi In and Midi Out Ports<br>Monitor Port (RGB Analog; high-resolution monochrome and audio)<br>Parallel Interface Printer Port (IBM®-style plug, Centronics® signal specifications)<br>RS232C Serial Modem Port<br>Floppy Disk Port (includes controller)<br>Hard Disk Port (10 megabits per second DMA transfer rate)<br>ROM Cartridge Port (128 Kilobytes capacity)<br>Mouse/Joystick and Joystick Ports |
| <b>Sound Generator:</b>                  | 3 voices from 30 Hz to above audible range   |
| <b>Keyboard:</b>                         | 94-key intelligent keyboard using a 6301 microprocessor  |
| <b>Power Supply:</b>                     | + 5V ± 5% @ 2A<br>+ 12V ± 10% @ 30MA<br>- 12V ± 10% @ 30MA   |



## **CUSTOMER SUPPORT**

Atari Corp. welcomes any questions you might have about your ATARI Computer product.

### **Write to:**

Atari Customer Relations  
P.O. Box 61657  
Sunnyvale, CA 94088

Please write the subject of your letter on the outside of the envelope.

We suggest that you contact your local Atari User Groups. They are outstanding sources of information on how to get the most out of your ATARI Computer. To receive a list of the user groups in your area, send a self-addressed stamped envelope to:

Atari User Group List  
P.O. Box 61657  
Sunnyvale, CA 94088

# HELP FOR YOUR ST™ COMPUTER

**Get the most from your computer with Atari® Explorer™ and save 50% off the cover price.**

Atari doesn't just make great computers—we publish the very best magazine for users of our computers. Straight from the source. With access to the same wizards who designed the computers.

Each issue of *Atari Explorer* brings:

- NEWS on products, services, and trends—with the accent on how this will effect *you*.
- REVIEWS of software, hardware, and books—you'll know what the best products are and exactly what they can do.
- TUTORIALS on all aspects of computing—for beginners and for experts.
- COLUMNS on user groups, Logo programming, telecomputing, education, and more.
- THE INSIDE STORY on what's happening in the new Atari Corp.
- PROGRAMS to type in and use on your computer.
- UPDATES to manuals and product announcements—no one is more timely and more accurate.
- APPLICATIONS you might not have thought of to help you make the most from your computer system.

We're not just a magazine about machines—*Atari Explorer* is for *people who use computers* and we make sure that there is plenty of interesting material in every issue.

Take advantage of this special offer. Subscribe now and save 50 cents off the newsstand price—or save even more with an 18 issue subscription to the only magazine published by Atari for you.



NO POSTAGE  
NECESSARY  
IF MAILED  
IN THE  
UNITED STATES

---

## BUSINESS REPLY CARD

FIRST CLASS PERMIT NO. 7283 SUNNYVALE, CA

---

POSTAGE WILL BE PAID BY ADDRESSEE

ATARI EXPLORER  
P.O. BOX 3427  
SUNNYVALE, CA 94088-3427



**ATARI**

Atari Corp., Sunnyvale, CA 94086  
©1985 Atari Corp.  
All Rights Reserved.

**PRINTED IN TAIWAN**  
**C026051-001 REV. B**

K. I. 7. 1985